

**APPLICATION FOR A CERTIFICATE OF APPROPRIATENESS FOR  
A SIGN IN A SPECIAL PROVISION SIGN DISTRICT (SPSD)**

**DOWNTOWN SPECIAL PROVISION SIGN DISTRICT - PERIMETER SUBDISTRICT**

**CASE NUMBER:** 2208220002  
**LOCATION:** 2550 Pacific Avenue  
(northwest elevation)

**DATE FILED:** August 22, 2022  
**SIZE OF REQUEST:** 245 sq. ft.

**COUNCIL DISTRICT:** 2

**ZONING:** CA-2 (A)

**APPLICANT:** Bobby Nichols of Chandler Signs, Inc.

**OWNER:** Westdale Properties

**TENANT:** Epic Office Dallas

**REQUEST:** An application for a Certificate of Appropriateness by Bobby Nichols of Chandler Signs, Inc., for a 245-square-foot illuminated attached sign at 2550 Pacific Avenue (northwest elevation).

**SUMMARY:** The applicant proposes to install a 245-square-foot LED-illuminated cabinet against the façade facing Pacific Avenue, bearing the name Epic, a logo, and the word Park with an arrow.

**STAFF RECOMMENDATION:** Approval

**SSDAC RECOMMENDATION:** Approval

**BACKGROUND:**

- The subject site is located in the Downtown Special Provision Sign District within the Perimeter Subdistrict and is zoned CA-2(A). Central Area is considered a business zoning sign district.

These regulations are established in: [Sec. 51A-7.305](#) (Specific details included below).

- The applicant proposes to install a 245-square-foot LED-illuminated cabinet against the façade facing Pacific Avenue, bearing the name Epic, a logo, and the word Park with an arrow. This 18-inch aluminum sign cabinet will be painted to match 3M Intense Blue. The lettering and logo are to be routed and backed with white plastic, which will be illuminated with white LED. The cabinet is to be mounted on the northwest facade with a slight angle at the corner of the facade. The sign will project 18-inches beyond the corner of the facade, connecting with the identical Sign A on the northeast facade. The angles and application of these signs are intended to mimic the architecture of the building while promoting visibility and compliance with the sign provisions for the district. All sign elements are constructed entirely of metal, plastic, and LED lighting.
- This is the first of two applications for this site. This sign is to be located on northeast elevation, and is submitted as Sign B. The second sign, Sign A, is under review as CA 2208220001 and is located on the northeast facade. Both signs are of identical construction and are proposed to cover the north corner of the building.
- Construction of the proposed sign is in accordance with SPSD regulations and meets the requirements of the Dallas City Code per Sec. 51A-7.305 and 51A-7.900.

**51A-7.902 PURPOSE.**

The purpose of this division is to regulate both the construction of new signs and the alterations of existing signs with a view towards enhancing, preserving, and developing the unique character of the downtown area while addressing the diversity of businesses and promoting the economy of downtown. The general objectives of this division include those listed in Section [51A-7.101](#) as well as aesthetic considerations to ensure that signs are appropriate to the architecture of the district, do not obscure significant architectural features of its buildings, and lend themselves to the developing retail and residential uses and the pedestrian character of the area. The district regulations are in large part inspired by the high level of pedestrian activity and the need to maximize effective orientation of signage toward the walking public. (Ord. Nos. 19455; 20167; 21404; 24606)

**51A-7.305 ATTACHED SIGNS.**

(b) All signs and their words shall be mounted parallel to the building surface to which they are attached, and shall project no more than 18 inches from that surface except as provided in Subsection (e) below.

(c) On the primary facade, the combined effective area of all attached signs may not exceed 25 percent of the total area of the primary facade. On each secondary facade, the combined effective area of all attached signs may not exceed 15 percent of the total area of that secondary facade. As applied to a building with multiple occupants, the facade area of each use with a separate certificate of occupancy shall be treated as a separate facade. On any building facade, there may be a maximum of eight words which contain any character of a height equal to or exceeding four inches and pertain to any premise or any non-residential occupancy. Words consisting of characters less than four inches high may be used without limit.

*The total area of the northwest façade is approximately 67,500-square-feet. Sign B occupies less than one-percent of the façade. The existing "biscuits. tops. taps." sign, approved under permit number 1908301013 in October 2019 is approximately 48-square-feet. The existing Westdale sign, at approximately 230-square-feet, was approved under CA 1910150019 in January 2020. The total effective area of all signs on the entire northwest facade does not exceed one-percent of the total facade area. The word count on the proposed Sign B does not exceed eight words over four-inches in height.*

*(Code analysis continued on following page)*

**51A-7.505 PERMIT PROCEDURES FOR SPECIAL PROVISION SIGN DISTRICTS.**

(B) **Factors the committee shall consider.** In reviewing an application, the committee shall first consider whether the applicant has submitted sufficient information for the committee to make an informed decision. If the committee finds the proposed sign to be consistent with the special character of the special provision sign district, the committee shall make a recommendation of approval to the city plan commission. **The committee shall consider the proposed sign in terms of its appropriateness to the special provision sign district with particular attention to the effect of the proposed sign upon the economic structure of the special provision sign district and the effect of the sign upon adjacent and surrounding premises without regard to any consideration of the message conveyed by the sign.** After consideration of these factors, the committee shall recommend approval or denial of the application and forward that recommendation to the city plan commission.

(6) Decision by the commission. Upon receipt of a recommendation by the committee, the commission shall hold a public hearing to consider the application. At least 10 days before the hearing, notice of the date, time, and place of the hearing, the name of the applicant, and the location of the proposed sign must be published in the official newspaper of the city and the building official shall serve, by hand-delivery or mail, a written notice to the applicant that contains a reference to this section, and the date, time, and location of this hearing. A notice sent by mail is served by depositing it properly addressed and postage paid in the United States mail. In addition, if the application is for a detached sign or for an attached sign that has more than 100 square feet of effective area, the applicant must post the required number of notification signs in accordance with Section 51A-1.106. **In making its decision, the commission shall consider the same factors that were required to be considered by the committee in making its recommendation.** If the commission approves the application, it shall forward a certificate of appropriateness to the building official within 15 days after its approval. If the commission denies the application, it shall so inform the building official in writing. Upon receipt of the written denial, the building official shall so advise the applicant within five working days of the date of receipt of the written notice.



**Property Ownership**

Westdale Properties  
2550 Pacific Avenue  
Dallas, TX 75226

Officer names: Joseph G Beard - President

**Tenant Ownership**

Epic Office Dallas  
2550 Pacific Avenue  
Dallas, TX 75226

Officer names: Joseph G Beard - President

**SSDAC Action:**

**September 13, 2022**

**MOTION:** It was moved to **approve**:

An application for a Certificate of Appropriateness by Bobby Nichols of Chandler Signs, Inc., for a 245-square-foot illuminated attached sign at 2550 Pacific Avenue (northwest elevation).

Maker: Dumas  
Second: Hardin  
Result: Carried: 4 to 0

For: 4 - Peadon, Webster, Hardin, and Dumas

Against: 0 - none







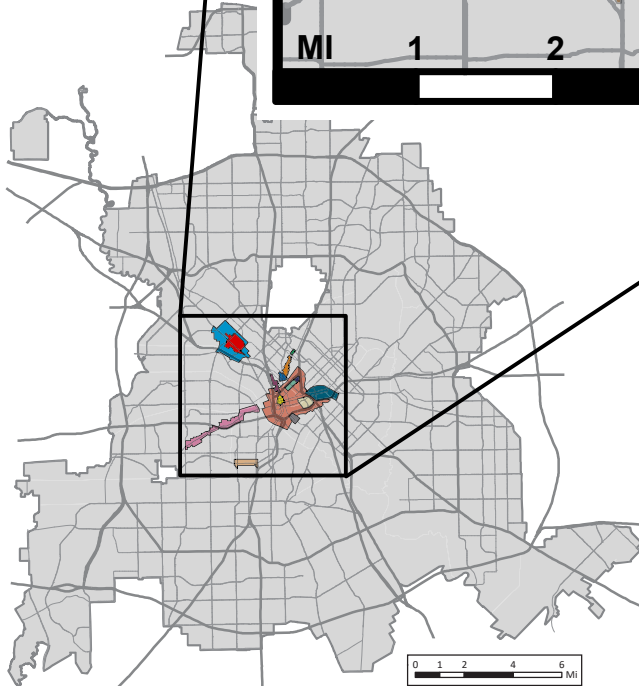
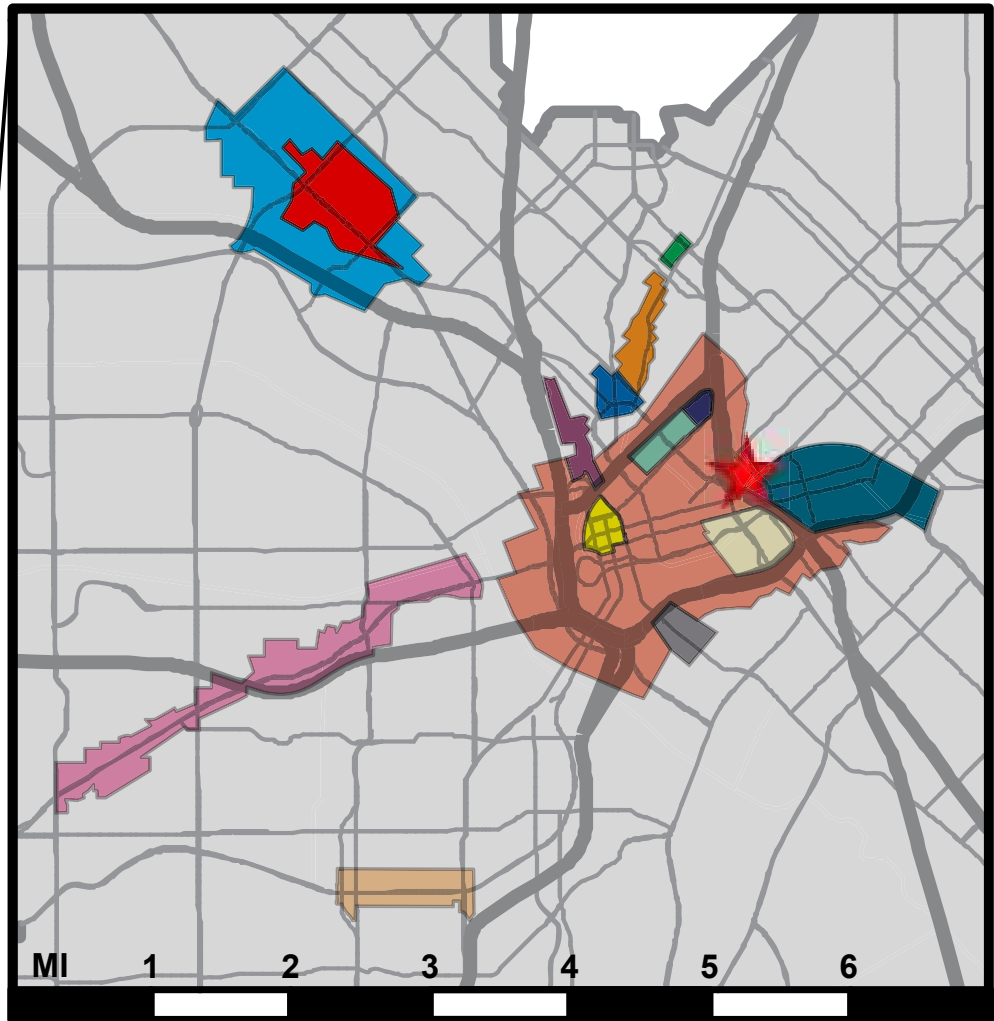

Absent: 1 - Haqq

Conflict: 0 - none

Speakers: Richard Brown of Chandler Signs



**LEGEND**

-  - Downtown
-  - West End
-  - Southside Entertainment
-  - Farmers Market
-  - Deep Ellum
-  - Arts District
-  - Arts District Extension
-  - Uptown
-  - McKinney Avenue
-  - West Village
-  - Jefferson Special Purpose District
-  - Parkland Hospital
-  - Southwestern Medical District
-  - West Commerce Street / Fort Worth Avenue
-  - Victory Sign District



**SPSD MAP**  
**2550 Pacific Avenue**  
**Downtown Special Provision District**

Case no: 2208220002

Date: 08/22/2022

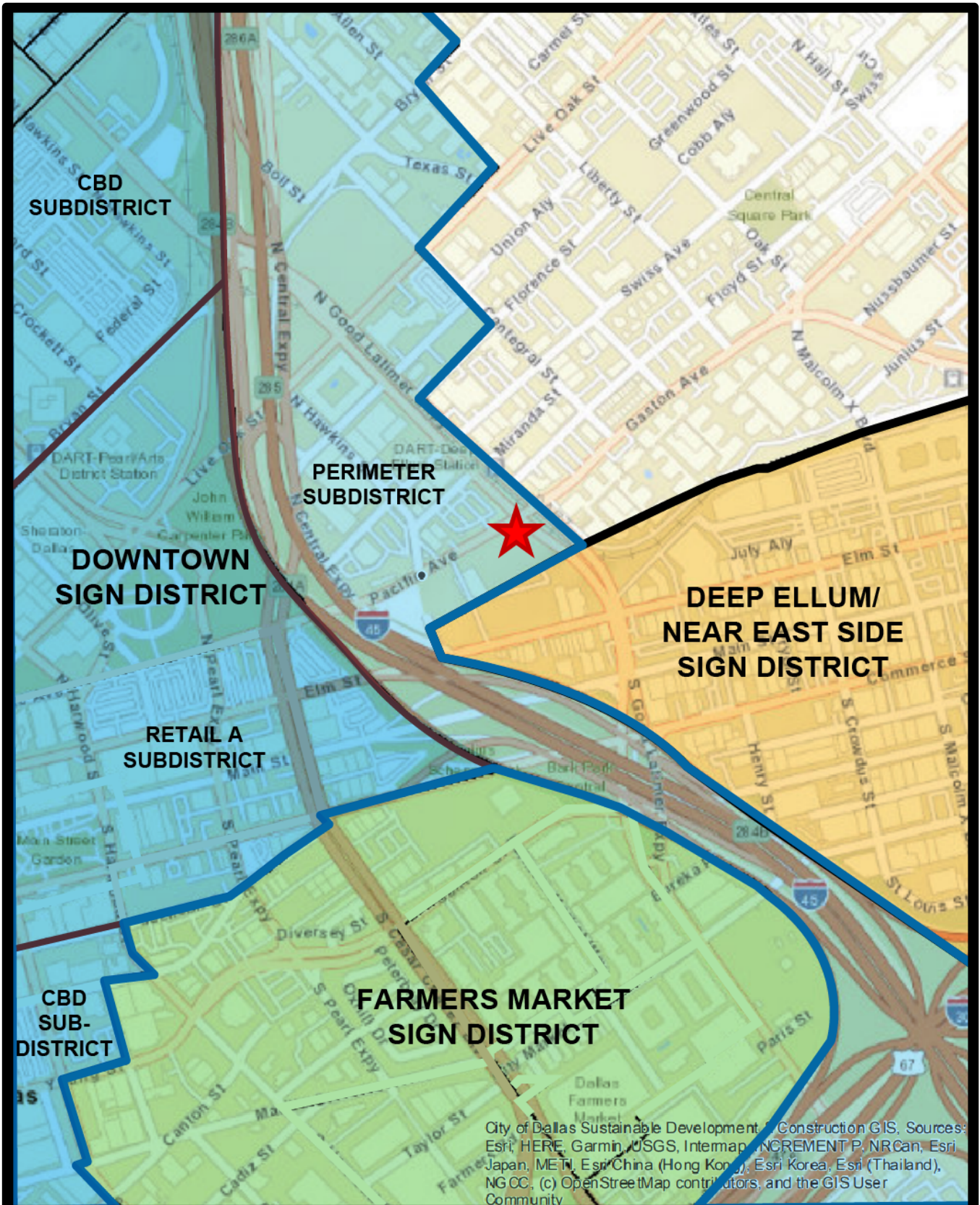

**SPSD MAP**  
**2550 Pacific Avenue**  
**Downtown Sign District - Perimeter**

Case no: **2208220002**

Date: **08/22/2022**



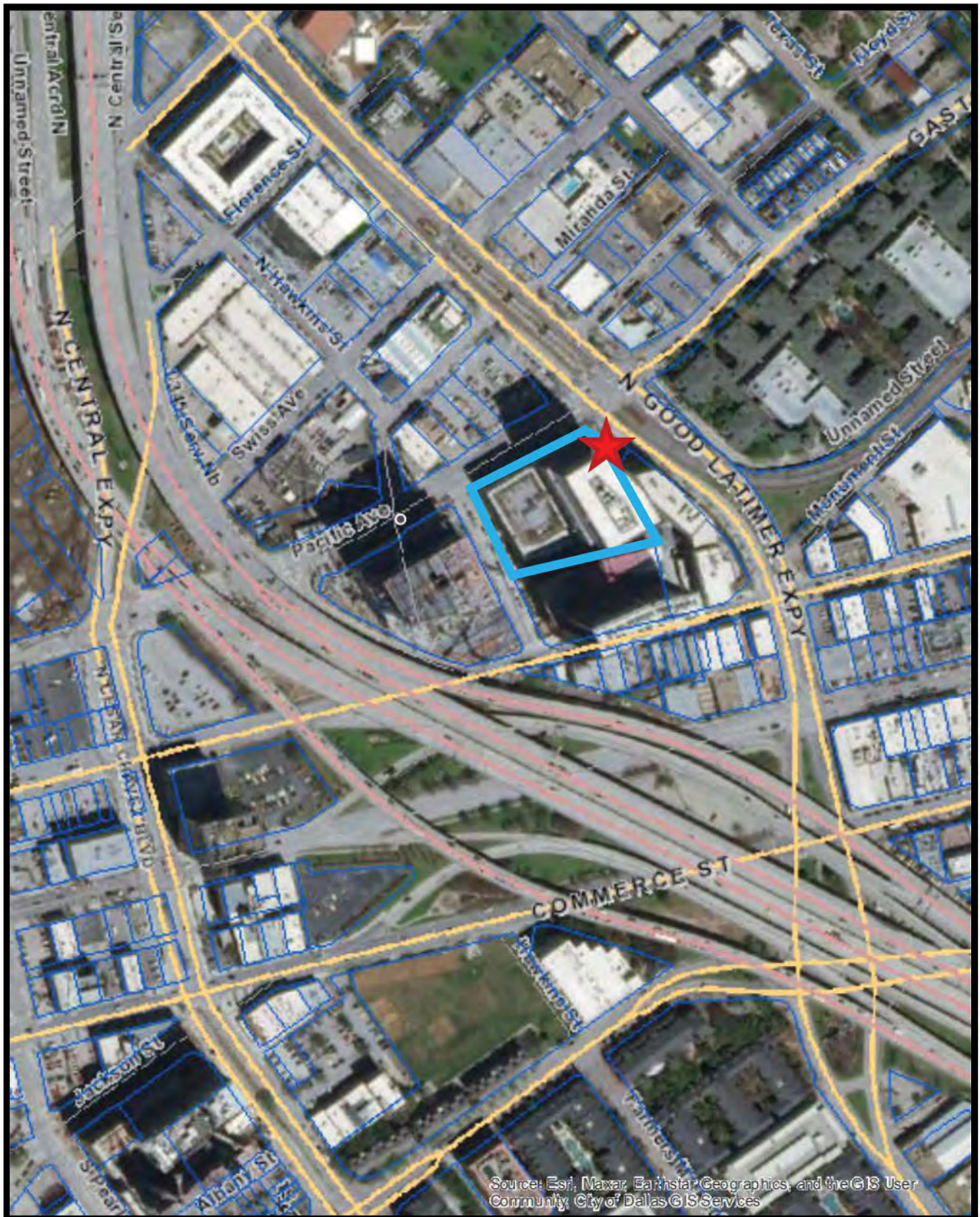

Source: Esri, Maxar, Earthstar Geographics, and the GIS User Community, City of Dallas GIS Services



# AERIAL MAP

## 2550 Pacific Avenue

Case no: 2208220002

Date: 08/22/2022



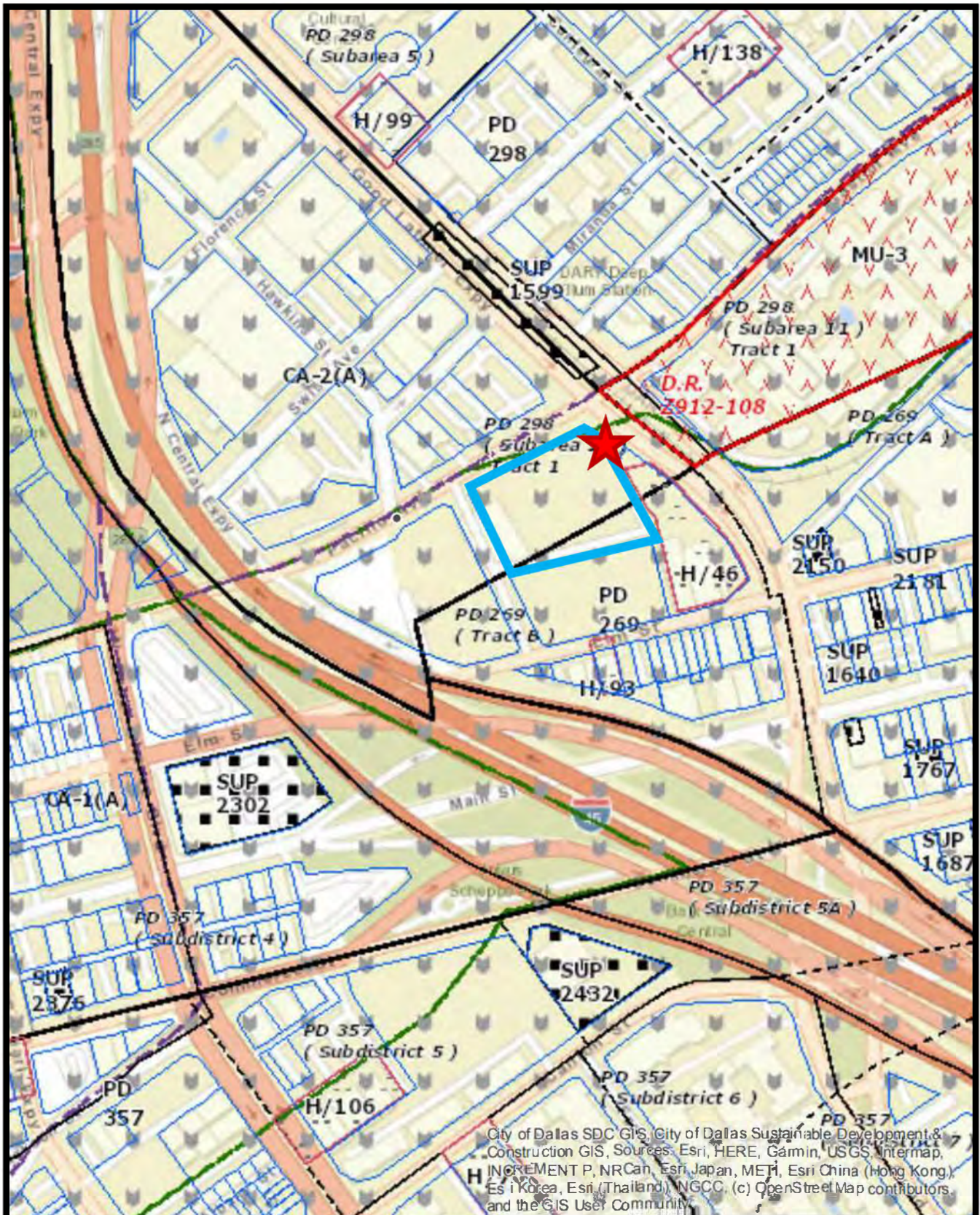

# ZONING MAP

## 2550 Pacific Avenue

Case no: 2208220002

Date: 08/22/2022



# SURROUNDING USES

- Parking
- Public Transportation
- Under Development
- Multi-Family
- Office
- Commercial Amusement
- Restaurant
- Fitness Center
- Animal Clinic
- Mixed Use
  - Hotel
  - Restaurant
  - Retail
- Mixed Use
  - Multi-Family
  - Restaurant
  - Retail
- Mixed Use
  - Office
  - Restaurant
  - Retail

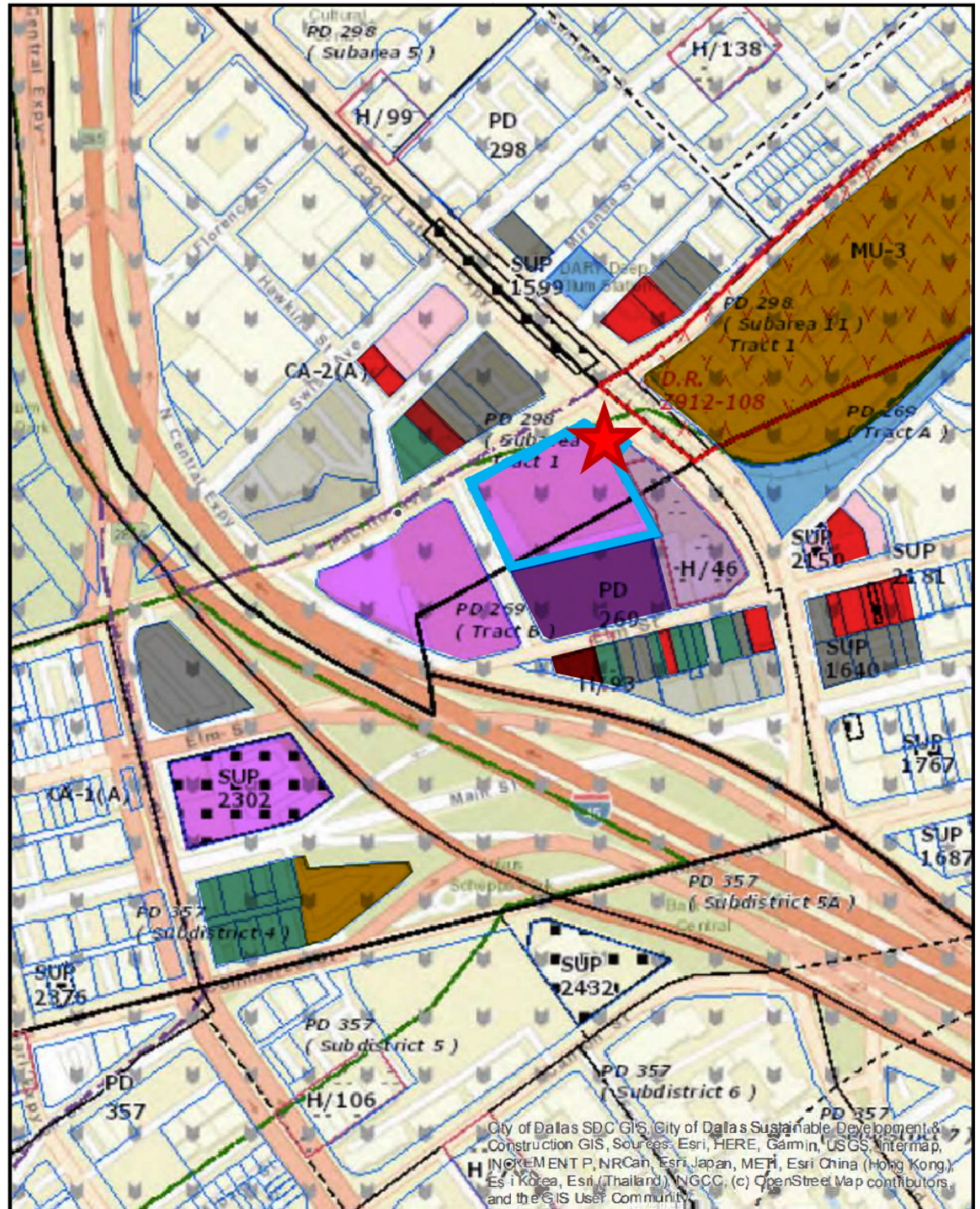

City of Dallas SDC GIS, City of Dallas Sustainable Development & Construction GIS, Sources: Esri, HERE, Garmin, USGS, Intermap, INCREMENT P, NRCan, Esri Japan, MEP, Esri China (Hong Kong), Esri Korea, Esri (Thailand), NGCC, (c) OpenStreet Map contributors, and the GIS User Community

# Job 173299932-002 (2208220002)

## Job Edit

### Miscellaneous Transaction Job 173299932-002 (2208220002)

#### Electrical Sign (ES)

Status: Paid

Created By: JPOOL

Date Created: Aug 22, 2022

Date Completed: Aug 22, 2022

Parent Job: 173299932-001 (2208171079)

Specific Location: 2550 PACIFIC AVE - ILLUMINATED ATTACHED SIGN - NW ELV (SIGN B)

## Details

Customer: NICHOLS, BOBBY  
 14201 Sovereign Rd Ste 101  
 Fort Worth, TX 76155  
 (972) 739-6557

Fee Amount

FeeType

Staff Email: JASON.POOL@DALLAS.GOV

## Details

Fees (EXT): 2208220002 5BN - Special Provision Sign District fee \$345.00  
Adjusted:\$0.00 Paid:\$345.00 Owed:\$0.00



Customer: NICHOLS, BOBBY  
14201 Sovereign Rd Ste 101  
Fort Worth, TX 76155 (972) 739-6557

## Fees

Description	Posted Date	Amount	Tax	Total	Balance
5BN - Special Provision Sign District fee		\$345.00	\$0.00	\$345.00	\$0.00
Receipt Number: 759746 \$345.00		(\$345.00)	\$0.00	(\$345.00)	
					<b>\$0.00</b>

## Processes

Assigned To	Status	Outcome	Scheduled		Actual	
			Start	Completed	Start	Completed
System Fee Collection						
SICASHIERINTERFACE	Complete	Collected				Aug 22, 2022 09:12:25
Auto generated System Fee Collection						



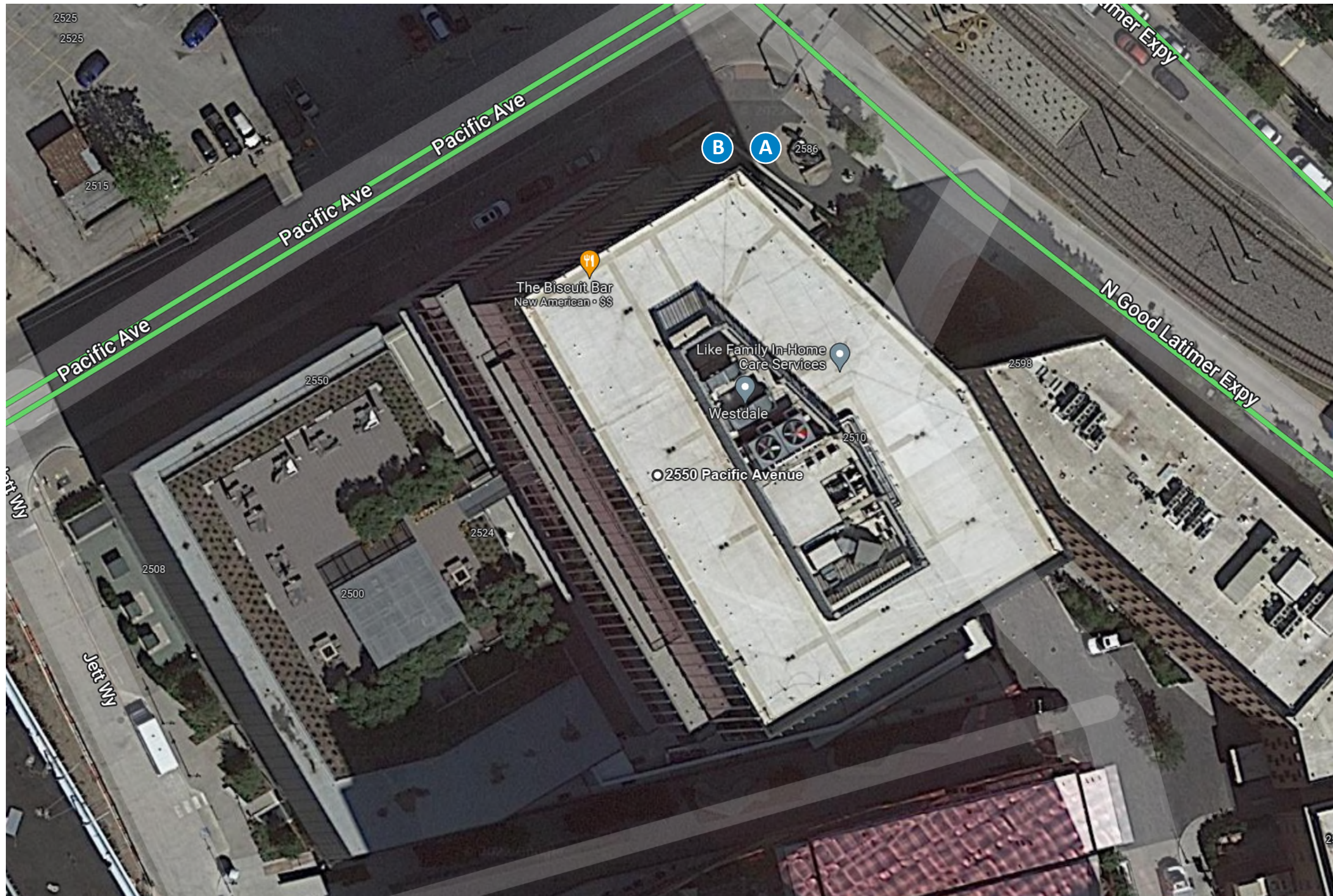

**SITE**



**THE EPIC**

Design #	0417126AR2
Sheet	3 of 3
Client	THE EPIC
Address	2550 PACIFIC AVE. DALLAS, TEXAS
Account Rep.	RICHARD BROWN
Designer	SDM
Date	4/29/22
Approval / Date	
Client	
Sales	
Estimating	
Art	
Engineering	
Landlord	

Revision / Date
R1-SDM-5/11/22-added arrow and increased sign height
R2-SDM-8/12/22-added bldg dims



chandler signs.com

<b>National Headquarters</b>	14201 Sovereign Road #101 Fort Worth, TX 76155 (214) 902-2000 Fax (214) 902-2044
<b>San Antonio</b>	17319 San Pedro Avenue Suite 200 San Antonio, TX 78232 (210) 349-3804 Fax (210) 349-8724
<b>Northeast US</b>	2301 River Road, Suite 201 Louisville, KY 40206 (502) 897-9800 Call (502) 554-2575
<b>Georgia</b>	111 Woodstone Place Dawsonville, GA 30534 (678) 725-8852 Fax (210) 349-8724
<b>South Texas</b>	PO BOX 125 206 Doral Drive Portland, TX 78374 (361) 563-5599 Fax (361) 643-6533

This drawing is the property of Chandler Signs, LLC. All rights to its use for reproduction are reserved by Chandler Signs, LLC.

**FINAL ELECTRICAL CONNECTION BY CUSTOMER**

THIS SIGN IS INTENDED TO BE INSTALLED IN ACCORDANCE WITH ARTICLE 690 OF THE NATIONAL ELECTRICAL CODE AND/OR OTHER APPLICABLE LOCAL CODES. THIS INCLUDES PROPER GROUNDING & BONDING OF THE SIGN. SIGN WILL BEAR UL LABEL(S).



249'-6" BUILDING HT.



**NORTHEAST CORNER - PROPOSED SIGN**



**THE EPIC**

Design #	0417126Ar3
Sheet	1 of 3
Client	THE EPIC
Address	2550 PACIFIC AVE. DALLAS, TEXAS
Account Rep.	RICHARD BROWN
Designer	SDM
Date	4/29/22
Approval / Date	
Client	
Sales	
Estimating	
Art	
Engineering	
Landlord	

Revision / Date	
R1-SDM-5/11/22	added arrow and increased sign height
R2-SDM-8/12/22	added bldg dims
R3 KMc 8/15	revised wall projection to 18"



chandler signs.com

<b>National Headquarters</b>	14201 Sovereign Road #101 Fort Worth, TX 76155 (214) 902-2800 Fax (214) 902-2844
<b>San Antonio</b>	17320 San Pedro Avenue Suite 700 San Antonio, TX 78237 (210) 349-3804 Fax (210) 349-8724
<b>Northeast US</b>	7301 River Road, Suite 201 Louisville, KY 40206 (502) 897-8800 Cell (502) 594-2375
<b>Georgia</b>	113 Woodstone Pkwy Lawsonville, GA 30244 (678) 725-8852 Fax (210) 348-8724
<b>South Texas</b>	PO BOX 125 205 Uvalde Drive Port Aransas, TX 78374 (361) 563-5289 Fax (361) 640-6333

This drawing is the property of Chandler Signs, LLC. All rights to its use for reproduction are reserved by Chandler Signs, LLC.

**FINAL ELECTRICAL CONNECTION BY CUSTOMER**

THIS SIGN IS INTENDED TO BE INSTALLED IN ACCORDANCE WITH ARTICLE 600 OF THE NATIONAL ELECTRICAL CODE AND/OR OTHER APPLICABLE LOCAL CODES. THIS INCLUDES PROPER GROUNDING & BONDING OF THE SIGN. SIGN WILL BEAR UL LABEL(S).







# THE EPIC

Design #

0417126Ar3

Sheet 2 of 3

Client

THE EPIC

Address

2550 PACIFIC AVE.  
DALLAS, TEXAS

Account Rep. RICHARD BROWN

Designer SDM

Date 4/29/22

Approval / Date

Client	
Sales	
Estimating	
Art	
Engineering	
Landlord	

Revision / Date

- R1-SDM-5/11/22-added arrow and increased sign height
- R2-SDM-8/12/22-added bldg dims
- R3 KMc 8/15: revised wall projection to 18"



chandler signs.com

National Headquarters 14201 Sovereign Road #101  
Fort Worth, TX 76155  
(214) 902-2800 Fax (214) 902-2844

San Antonio 17320 San Pedro Avenue  
Suite 700  
San Antonio, TX 78237  
(210) 349-3804 Fax (210) 349-8724

Northeast US 7301 River Road, Suite 201  
Lynchville, KY 40266  
(603) 887-8800 Cell (603) 594-2375

Georgia 113 Woodstone Pkwy  
Lawson Mill & Co. 30234  
(678) 725-8852 Fax (210) 348-8724

South Texas PO BOX 125 205 Uvalde Drive  
Port Aransas, TX 78374  
(361) 563-5289 Fax (361) 643-6333

This drawing is the property of Chandler Signs, LLC. All rights to its use for reproduction are reserved by Chandler Signs, LLC.

**FINAL ELECTRICAL CONNECTION BY CUSTOMER**

THIS SIGN IS INTENDED TO BE INSTALLED IN ACCORDANCE WITH ARTICLE 605 OF THE NATIONAL ELECTRICAL CODE AND/OR OTHER APPLICABLE LOCAL CODES. THIS INCLUDES PROPER GROUNDING & BONDING OF THE SIGN. SIGN WILL BEAR UL LABEL(S).

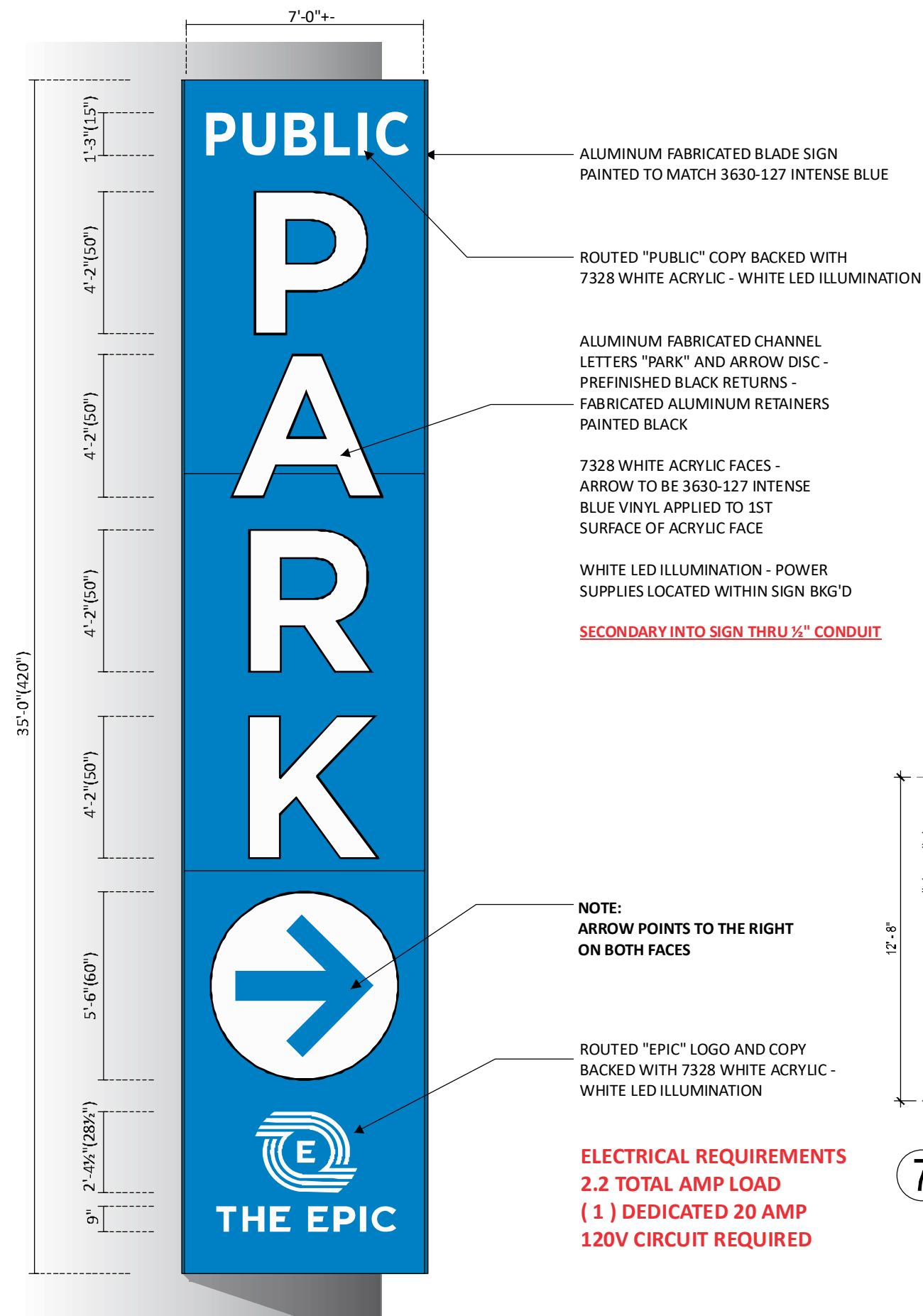

STEEL MTG. ANGLES ANCHORED TO METAL MESH SCREEN WALL AND FRAME AS REQUIRED

**EXACT SURVEY REQUIRED**

ALUMINUM TOP AND BOTTOM REMOVABLE FILLER PAINTED TO MATCH PMS 300C BLUE

### PLAN VIEW

SCALE: 1/4"=1'-0"

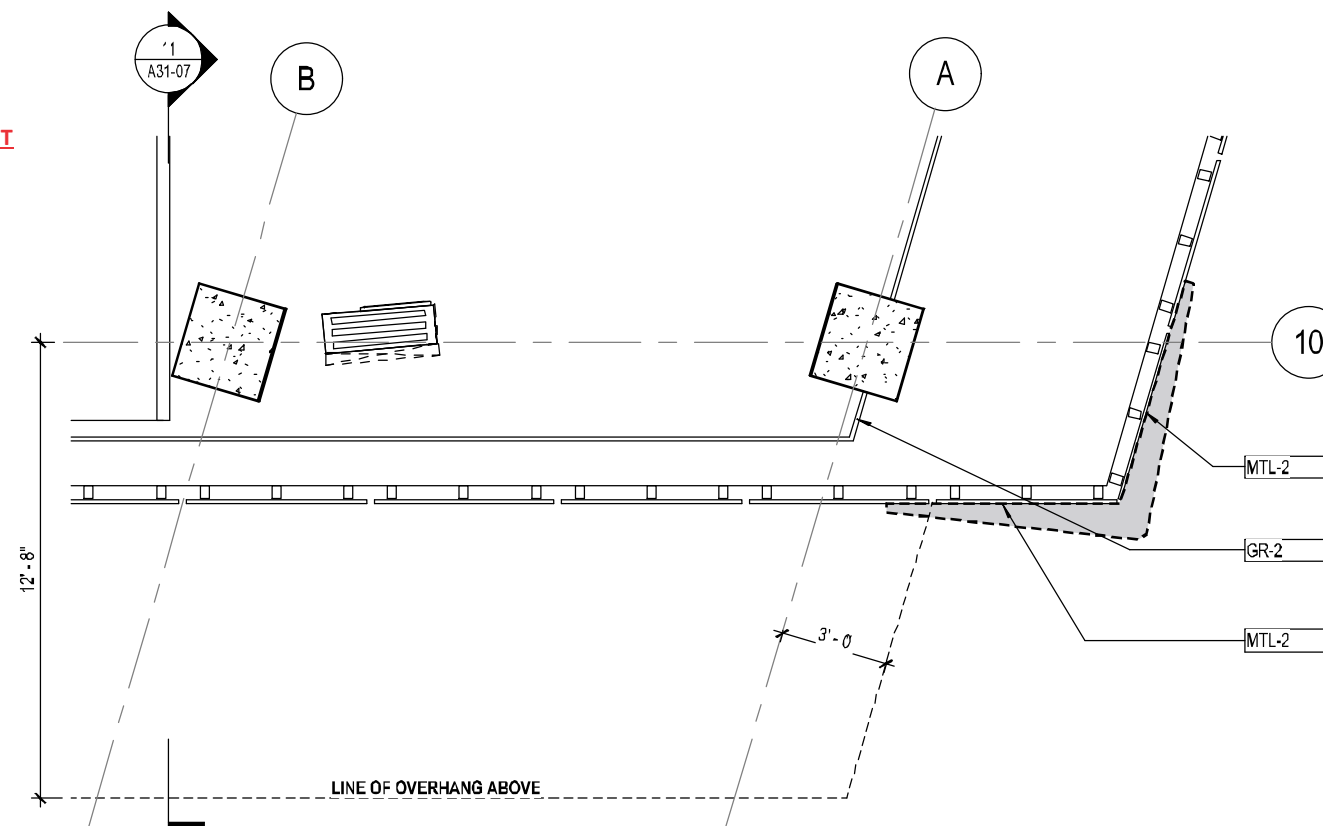

### 7 PARTIAL LEVEL 06 PLAN @ NORTHEAST CORNER

3/16"=1'-0"

A B

SCALE: 1/4"=1'-0"

245 SQ FT

**ELEVATION @ EACH FACE**

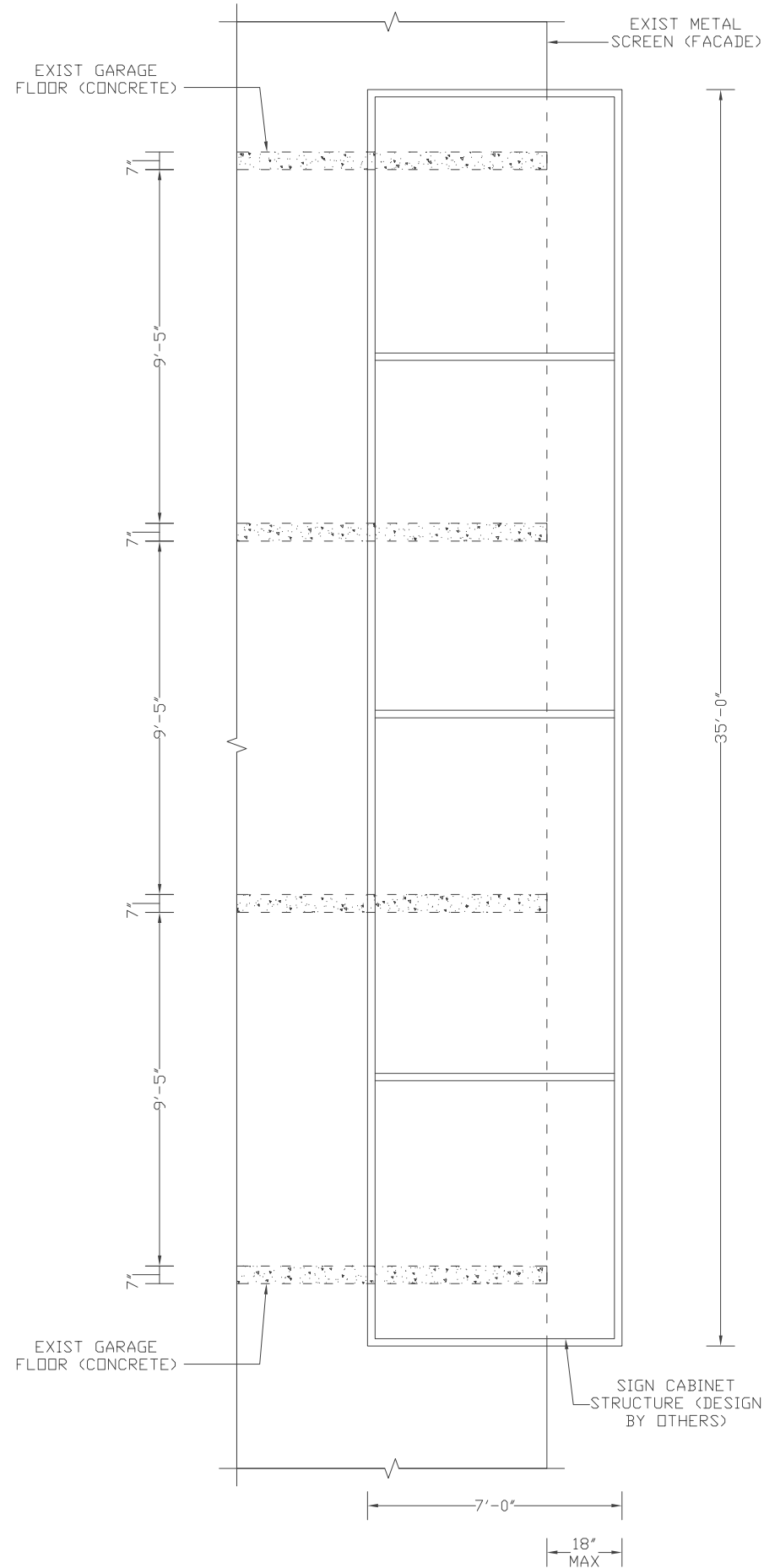

**IMPORTANT NOTE:**  
 BOLTS SHALL NOT BE CONNECTED TO EXISTING BUILDING FASCIA (EXISTING BUILDING FACADE/ METAL SCREEN) AT ANY LOCATION.

\*A:  
 2-3/4" DIAMETER GALVANIZED THREADED RODS (A36) @ EACH SUPPORT (TOTAL 32) w/ HILTI EPOXY (HY-200), L=9" (MIN EMBEDMENT IN EXISTING CONCRETE FLOOR)

**TOP VIEW**

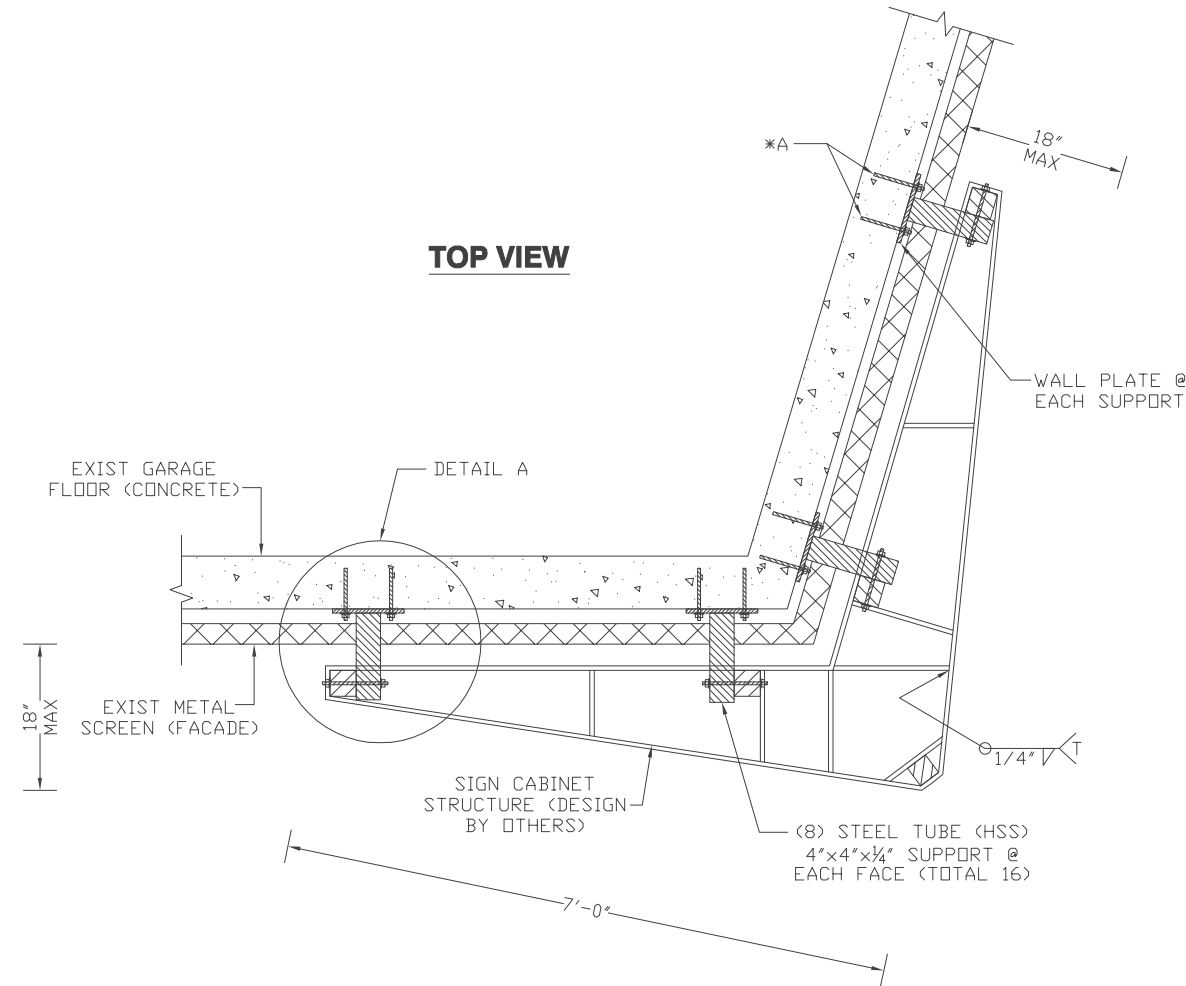

**DETAIL A**

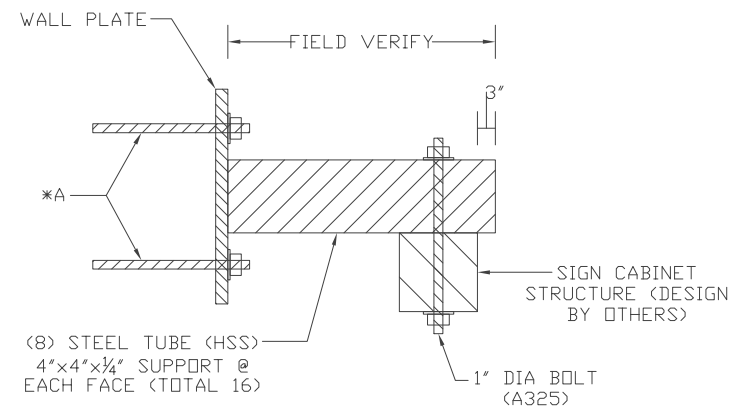

**WALL PLATE DETAILS**

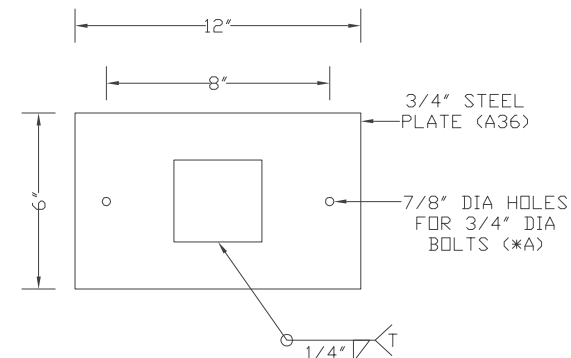

**NOTES:**

- DESIGN IS BASED ON 2021 IBC - WIND SPEED OF 115 MPH (3-SEC GUST), EXPOSURE C.
- THIS DESIGN IS INTENDED TO BE INSTALLED AT THE ADDRESS SHOWN AND SHALL NOT BE USED AT ANY OTHER LOCATIONS UNLESS CERTIFIED BY A PROFESSIONAL ENGINEER.
- ENGINEER IS NOT THE ENGINEER OF RECORD FOR THE OVERALL PROJECT AND SHALL ONLY BE RESPONSIBLE FOR THE DESIGN OF SIGN STRUCTURE FOR WHICH CALCULATIONS ARE SHOWN ON THIS PAGE. (SIGN FRAME STRUCTURE DESIGN SHALL BE PROVIDED BY OTHERS).
- ALL HSS TUBE SECTIONS SHALL MEET ASTM A500 GRADE-B WITH MINIMUM YIELD STRESS  $F_y=46$  KSI.
- ALL OTHER STEEL INCLUDING CONNECTION PLATES, ANGLES, ETC. SHALL MEET ASTM A36 WITH MINIMUM YIELD STRESS  $F_y=36$  KSI.
- ALL ALUMINUM USED SHALL BE GRADE 6053 OR 6061 OR EQUIVALENT WITH MINIMUM YIELD STRESS  $F_y=20$  KSI.
- STRUCTURAL BOLTS SHALL CONFORM TO ASTM A325 UNLESS OTHERWISE NOTED AND SHALL BE GALVANIZED.
- ALL STEEL WELDING SHALL BE MADE WITH E70xx ELECTRODES AND SHALL BE PERFORMED BY CERTIFIED WELDERS IN ACCORDANCE WITH AWS STANDARDS.
- ALL ALUMINUM WELDING SHALL BE MADE WITH E40xx ELECTRODES AND SHALL BE PERFORMED BY CERTIFIED WELDERS IN ACCORDANCE WITH AWS STANDARDS.
- SIZE, LENGTH & NUMBER OF BOLTS ARE MINIMUM RECOMMENDED AND SHALL BE INCREASED DEPENDING ON FIELD CONDITIONS TO SECURE SIGN FIRMLY ONTO EXISTING BUILDING STRUCTURE.
- BOLTS SHALL BE CONNECTED TO EXISTING BUILDING STRUCTURE (FRAME) AT ALL LOCATIONS.
- EXISTING BUILDING STRUCTURE INFORMATION NOT PROVIDED BY SIGN CONTRACTOR.
- ANALYSIS OF EXISTING BUILDING STRUCTURE TO SUPPORT PROPOSED LOADS NOT IN SCOPE OF SMB ENGINEERING, LLC AND DESIGN ENGINEER AND HENCE NOT PERFORMED AND PROVIDED.
- SMB ENGINEERING, LLC AND DESIGN ENGINEER SHALL NOT BE HELD RESPONSIBLE FOR DAMAGE CAUSED TO EXISTING BUILDING DUE TO ADDITION OF PROPOSED LOADS.



**SMB ENGINEERING, LLC**  
 WWW.SMB-ENGINEERING.COM  
 TEL: 832-443-7328

TEXAS REGISTRATION NUMBER : F-10116

**CHANDLER SIGNS**  
 17319 SAN PEDRO AVE.,  
 SAN ANTONIO, TX 78232

**THE EPIC**  
 2550 PACIFIC AVENUE,  
 DALLAS, TX

PRJ # : 22-G015	DWG BY : HMN	SCALE : NTS
DATE : AUG 2022	REV : 3	PAGE : 1 OF 1