



## Volume 2 – Data and Analysis Sheets

### Pepper Square Redevelopment

Dallas, Texas

Third Updated Submission: March 21, 2024  
Second Updated Submission: November 8, 2023  
First Updated Submission: September 9, 2022  
Original Submission: August 18, 2021

Kimley-Horn and Associates, Inc.  
Dallas, Texas

Project #063928006  
Registered Firm F-928

**Kimley»»Horn**



## TIA Exhibits for Background Developments

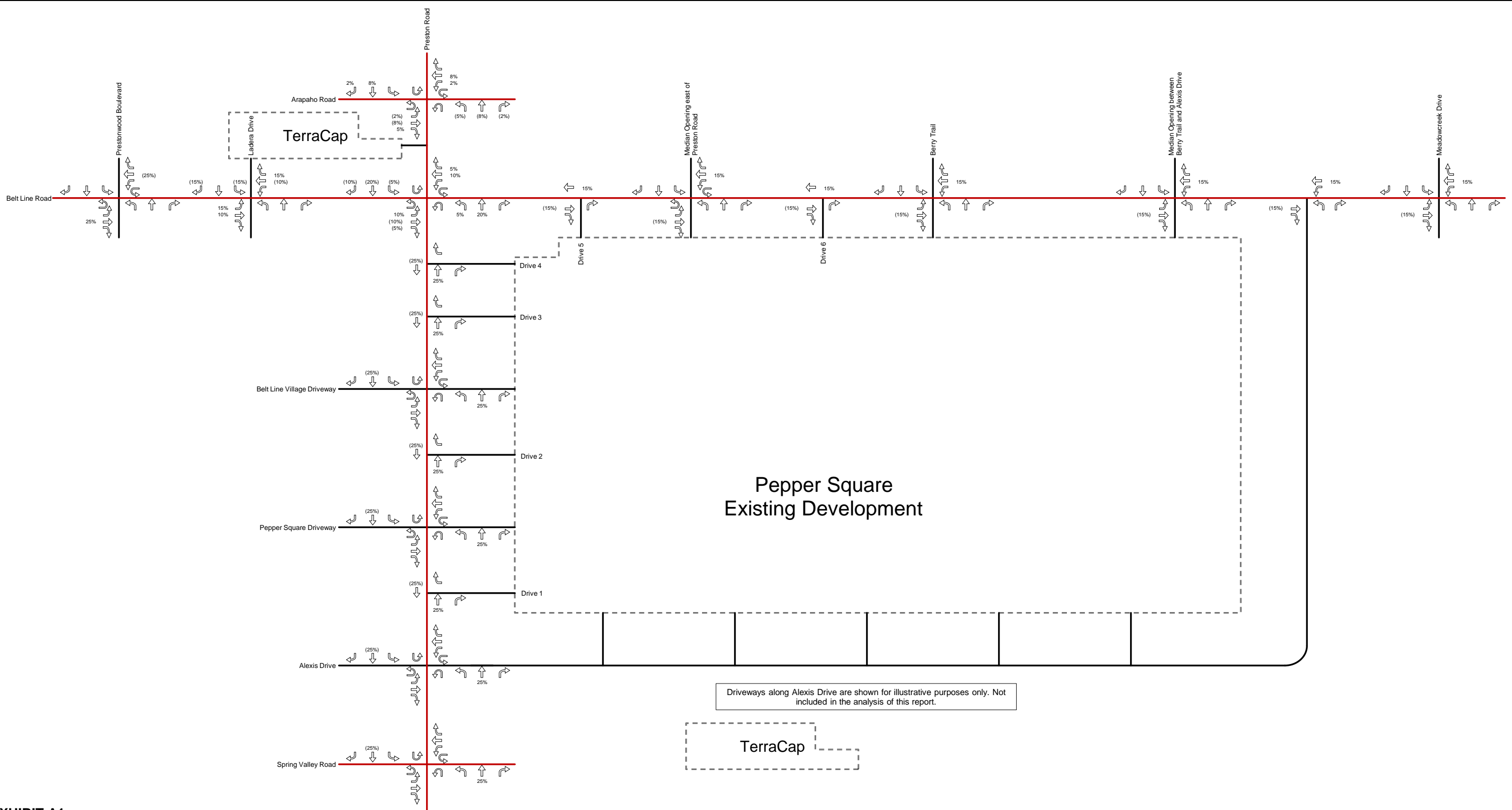
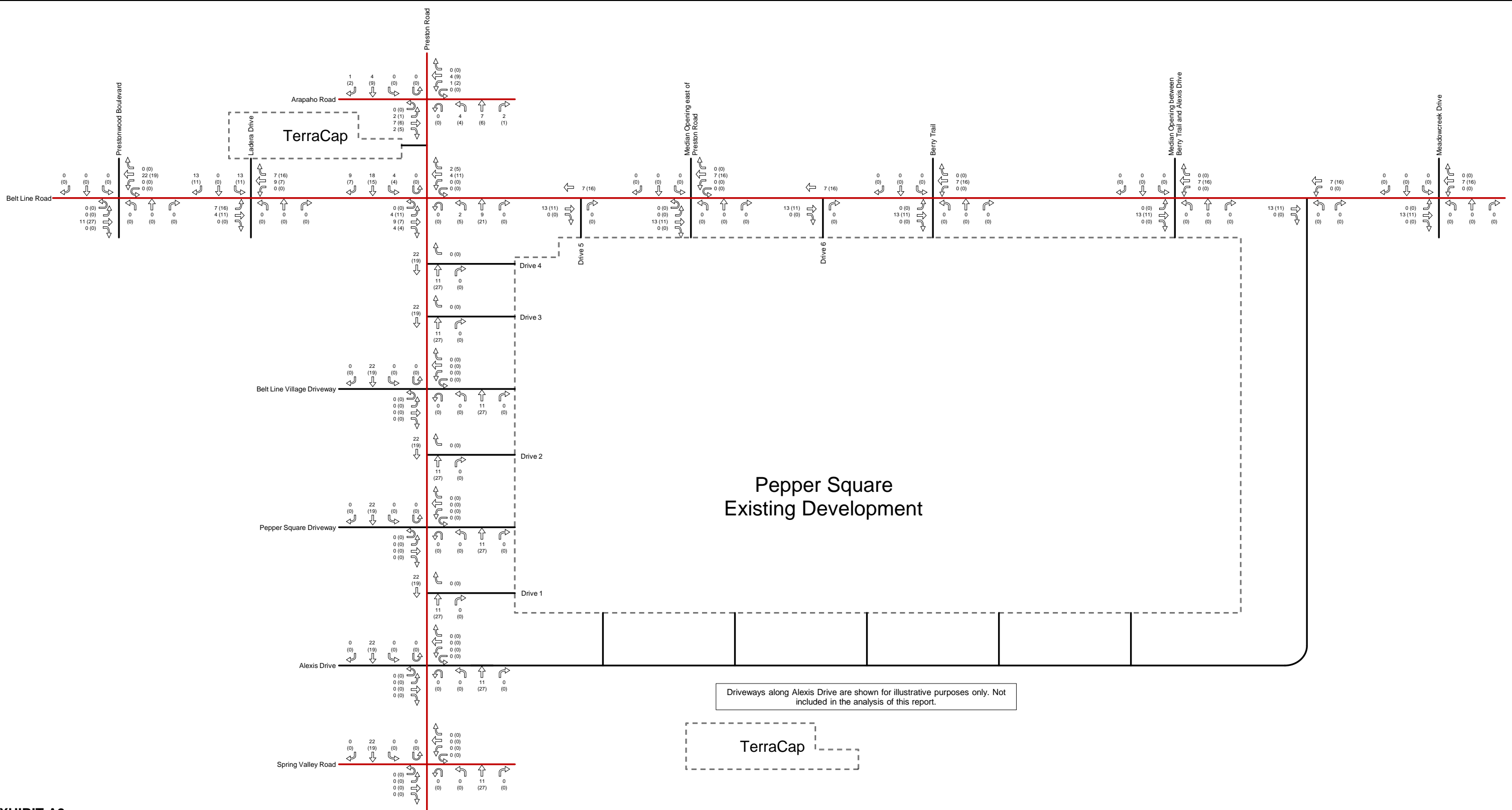

**EXHIBIT A1**  
 Trip Distribution and Traffic Assignment: Terracap Background Development (2026)  
 Pepper Square - Dallas, Texas



**LEGEND:**  
 X% (Y%)  
 X% = Percentage of Inbound Site-Generated Traffic  
 Y% = Percentage of Outbound Site-Generated Traffic



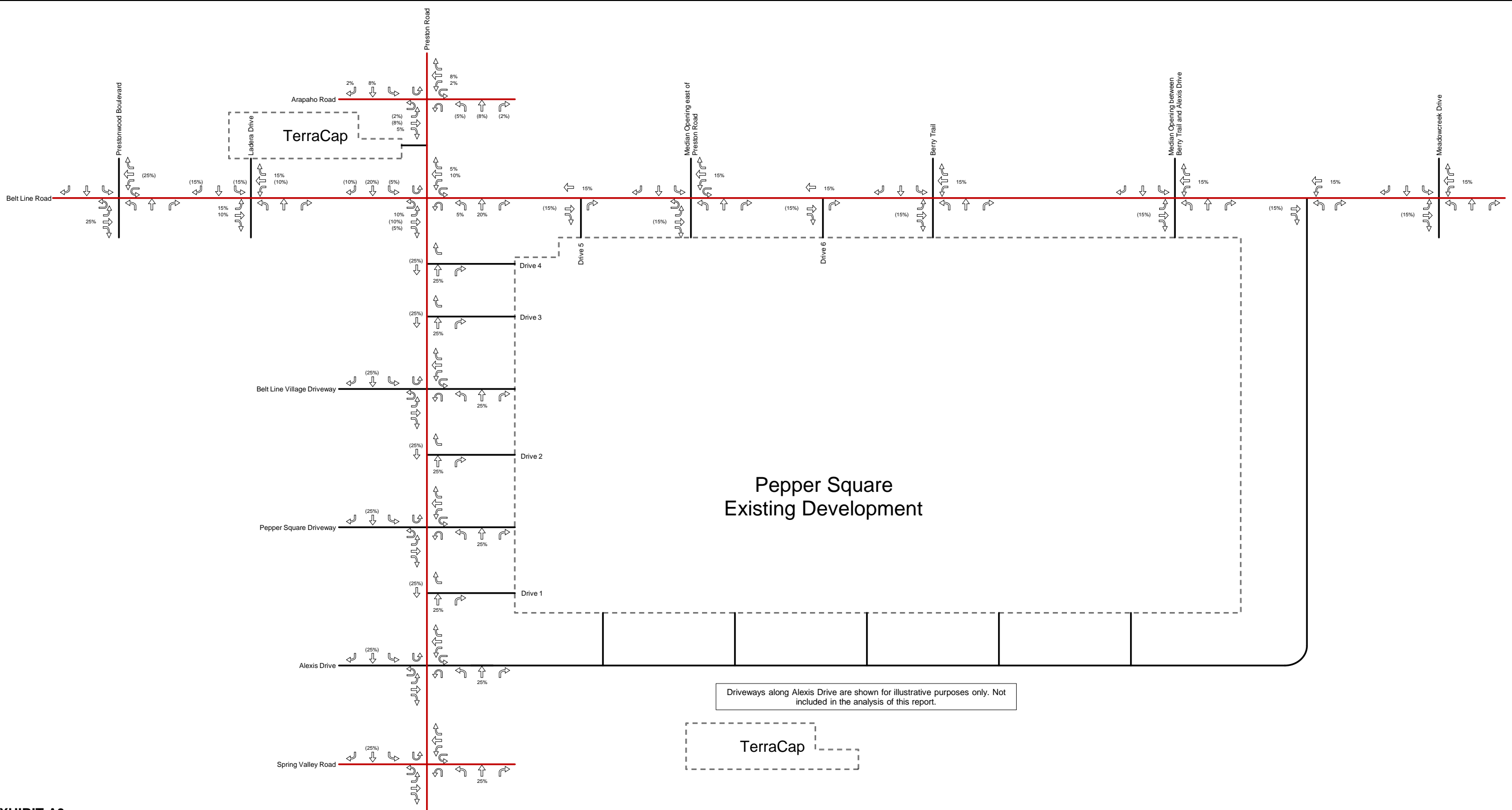

**EXHIBIT A2**  
 Site-Generated Traffic Volumes: Terracap Background Development (2026)  
 Pepper Square - Dallas, Texas



**LEGEND:**  
 X (Y)  
 X = Weekday AM Peak Hour Turning Movements  
 Y = Weekday PM Peak Hour Turning Movements  
 Volumes may not sum from point to point due to rounding  
 and presence of smaller driveways not included in analysis.



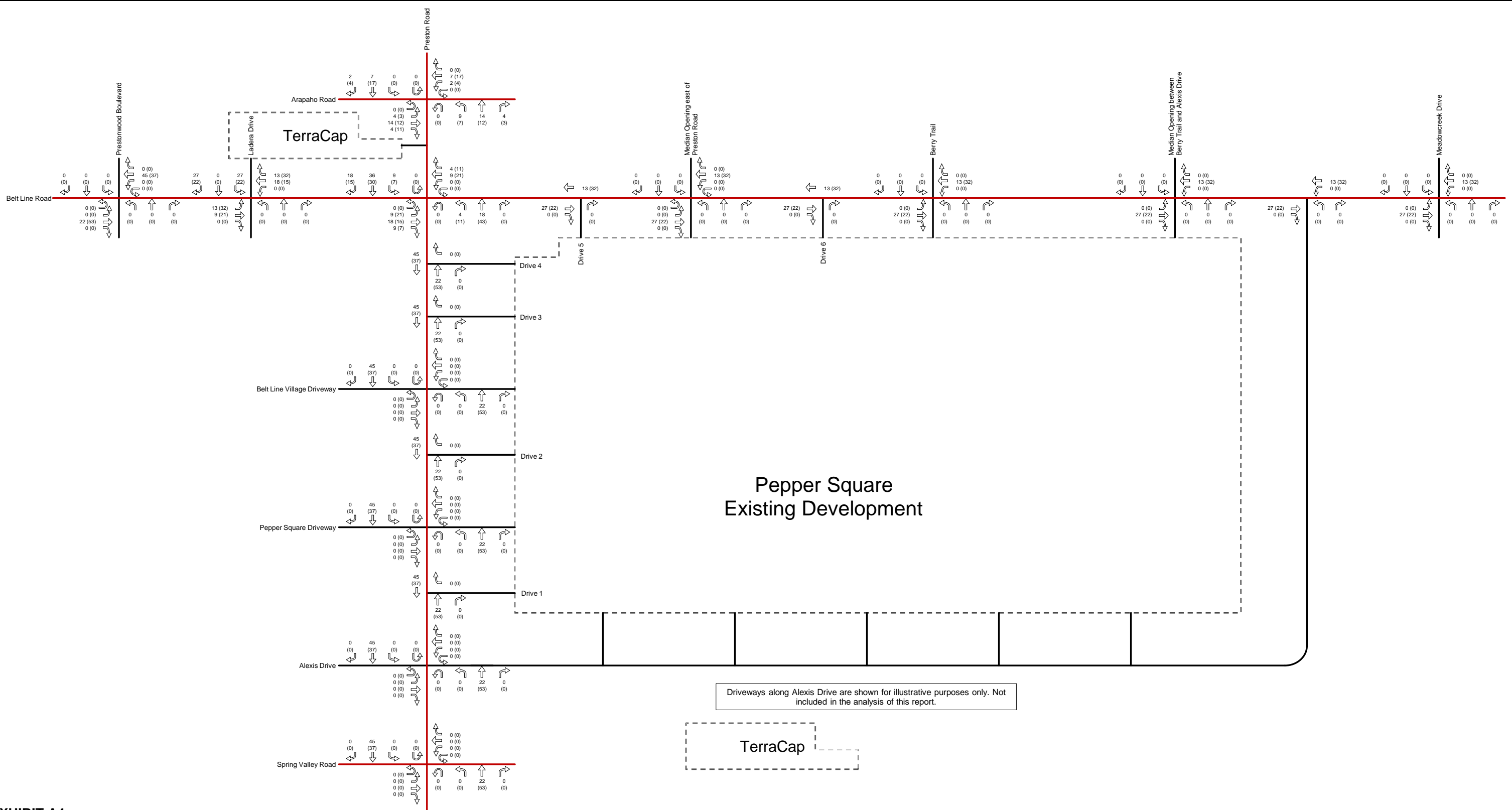

**EXHIBIT A3**  
 Trip Distribution and Traffic Assignment: Terracap Background Development (2028)  
 Pepper Square - Dallas, Texas



**LEGEND:**  
 X% (Y%)  
 X% = Percentage of Inbound Site-Generated Traffic  
 Y% = Percentage of Outbound Site-Generated Traffic





**EXHIBIT A4**  
 Site-Generated Traffic Volumes: Terracap Background Development (2028)  
 Pepper Square - Dallas, Texas



**LEGEND:**  
 X (Y)  
 X = Weekday AM Peak Hour Turning Movements  
 Y = Weekday PM Peak Hour Turning Movements  
 Volumes may not sum from point to point due to rounding  
 and presence of smaller driveways not included in analysis.



Not To Scale

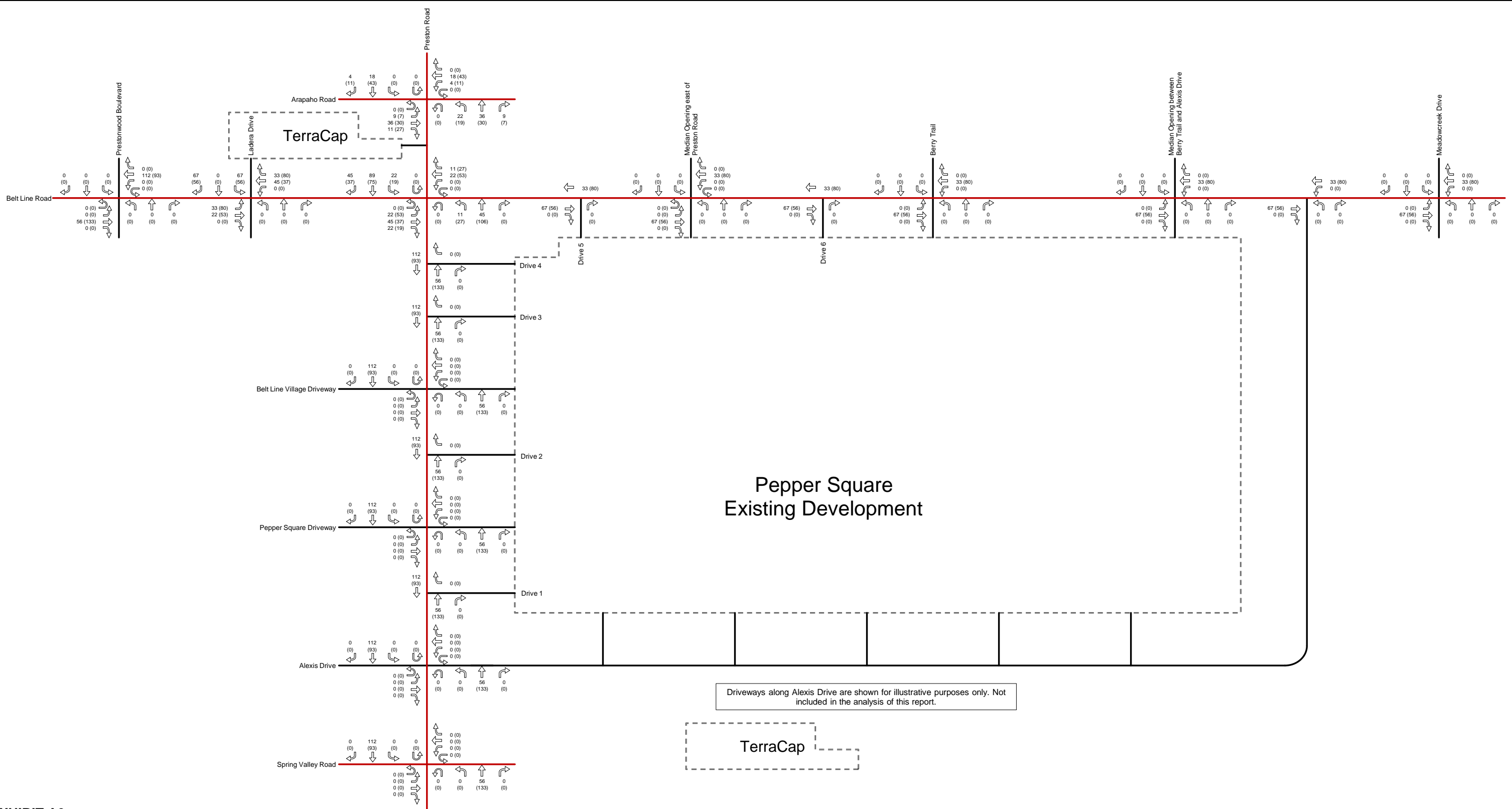

**EXHIBIT A5**  
 Trip Distribution and Traffic Assignment: Terracap Background Development (2033)  
 Pepper Square - Dallas, Texas



**LEGEND:**  
 X% (Y%)  
 X% = Percentage of Inbound Site-Generated Traffic  
 Y% = Percentage of Outbound Site-Generated Traffic





**EXHIBIT A6**  
 Site-Generated Traffic Volumes: TerraCap Background Development (2033)  
 Pepper Square - Dallas, Texas



**LEGEND:**  
 X (Y)  
 X = Weekday AM Peak Hour Turning Movements  
 Y = Weekday PM Peak Hour Turning Movements  
 Volumes may not sum from point to point due to rounding  
 and presence of smaller driveways not included in analysis.



Not To Scale





Driveways along Alexis Drive are shown for illustrative purposes only. Not included in the analysis of this report.

**EXHIBIT A7**  
 Trip Distribution and Traffic Assignment: Tonti Alexis (2026)  
 Pepper Square - Dallas, Texas



**LEGEND:**  
 X% (Y%)  
 X% = Percentage of Inbound Site-Generated Traffic  
 Y% = Percentage of Outbound Site-Generated Traffic



Not To Scale

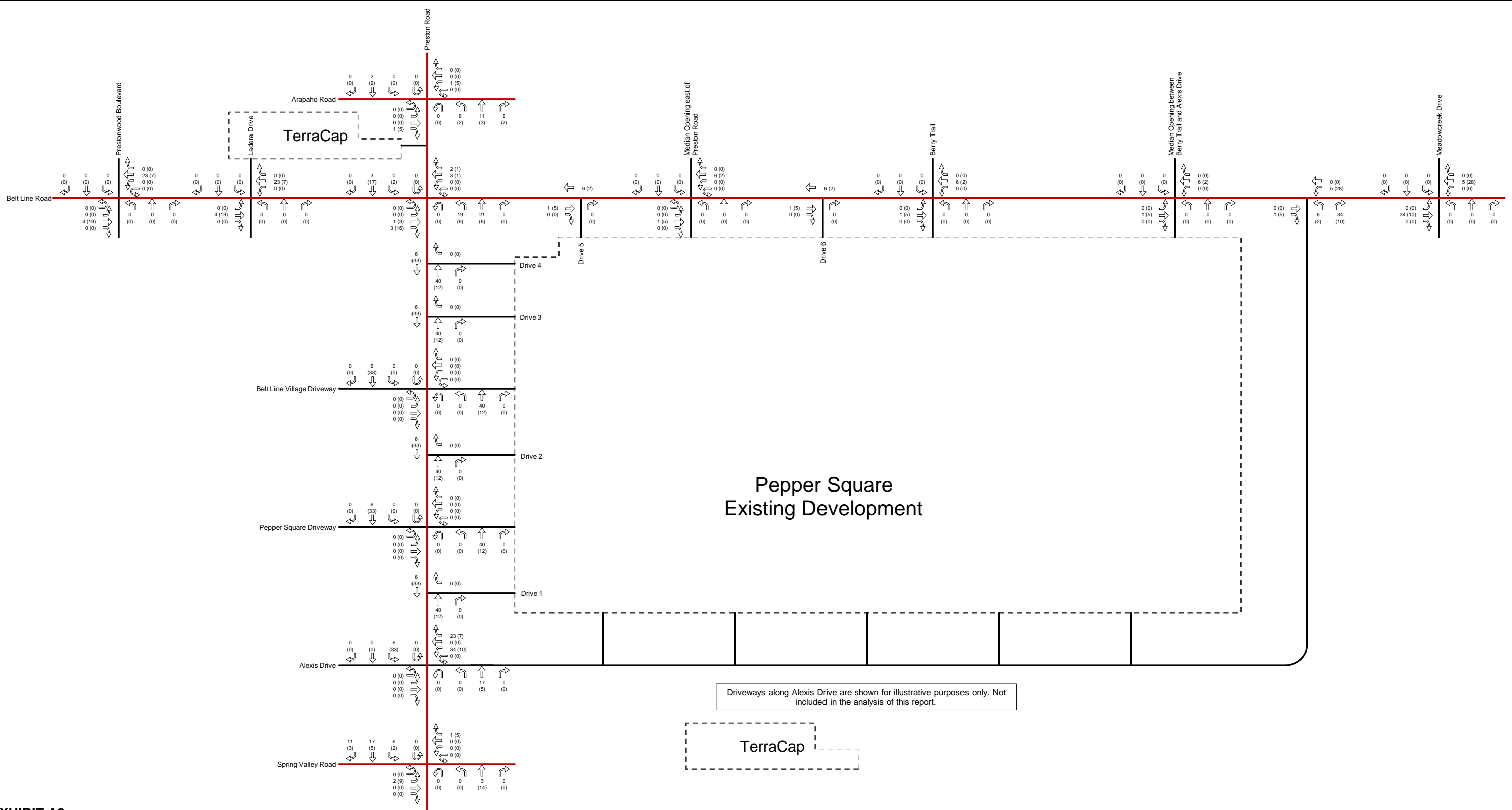

**EXHIBIT A8**  
 Site-Generated Traffic Volumes: Tonti Alexis (2026)  
 Pepper Square - Dallas, Texas



**LEGEND:**  
 X (Y)  
 X = Weekday AM Peak Hour Turning Movements  
 Y = Weekday PM Peak Hour Turning Movements  
 Volumes may not sum from point to point due to rounding  
 and presence of smaller driveways not included in analysis.



Not To Scale



Driveways along Alexis Drive are shown for illustrative purposes only. Not included in the analysis of this report.

**EXHIBIT A9**  
 Trip Distribution and Traffic Assignment: Tonti Alexis (2028)  
 Pepper Square - Dallas, Texas



**LEGEND:**  
 X% (Y%)  
 X% = Percentage of Inbound Site-Generated Traffic  
 Y% = Percentage of Outbound Site-Generated Traffic



Not To Scale

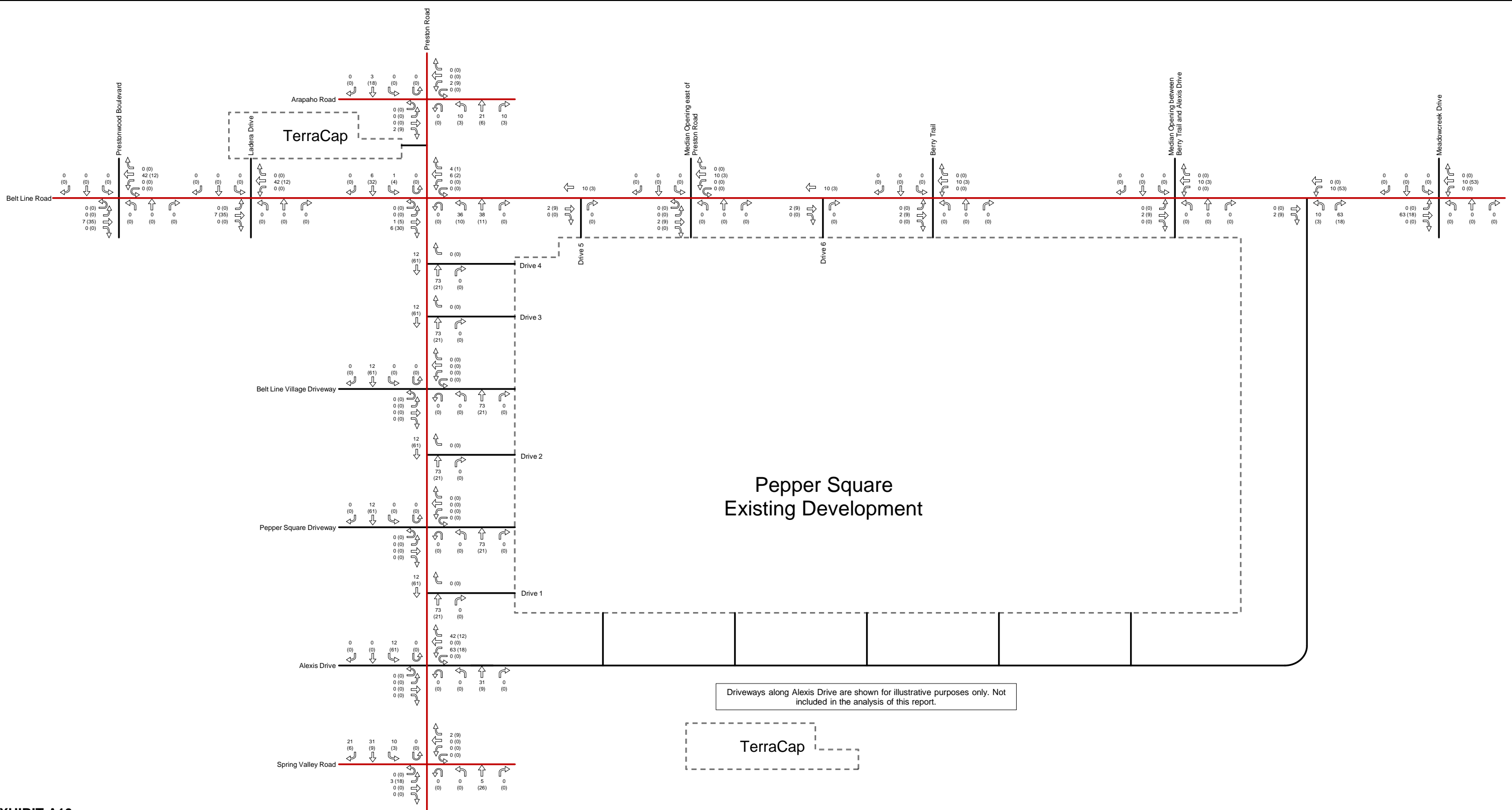

**EXHIBIT A10**  
 Site-Generated Traffic Volumes: Tonti Alexis (2028)  
 Pepper Square - Dallas, Texas



Driveways along Alexis Drive are shown for illustrative purposes only. Not included in the analysis of this report.

**EXHIBIT A11**  
 Trip Distribution and Traffic Assignment: Tonti Alexis (2033)  
 Pepper Square - Dallas, Texas



**LEGEND:**  
 X% (Y%)  
 X% = Percentage of Inbound Site-Generated Traffic  
 Y% = Percentage of Outbound Site-Generated Traffic



Not To Scale

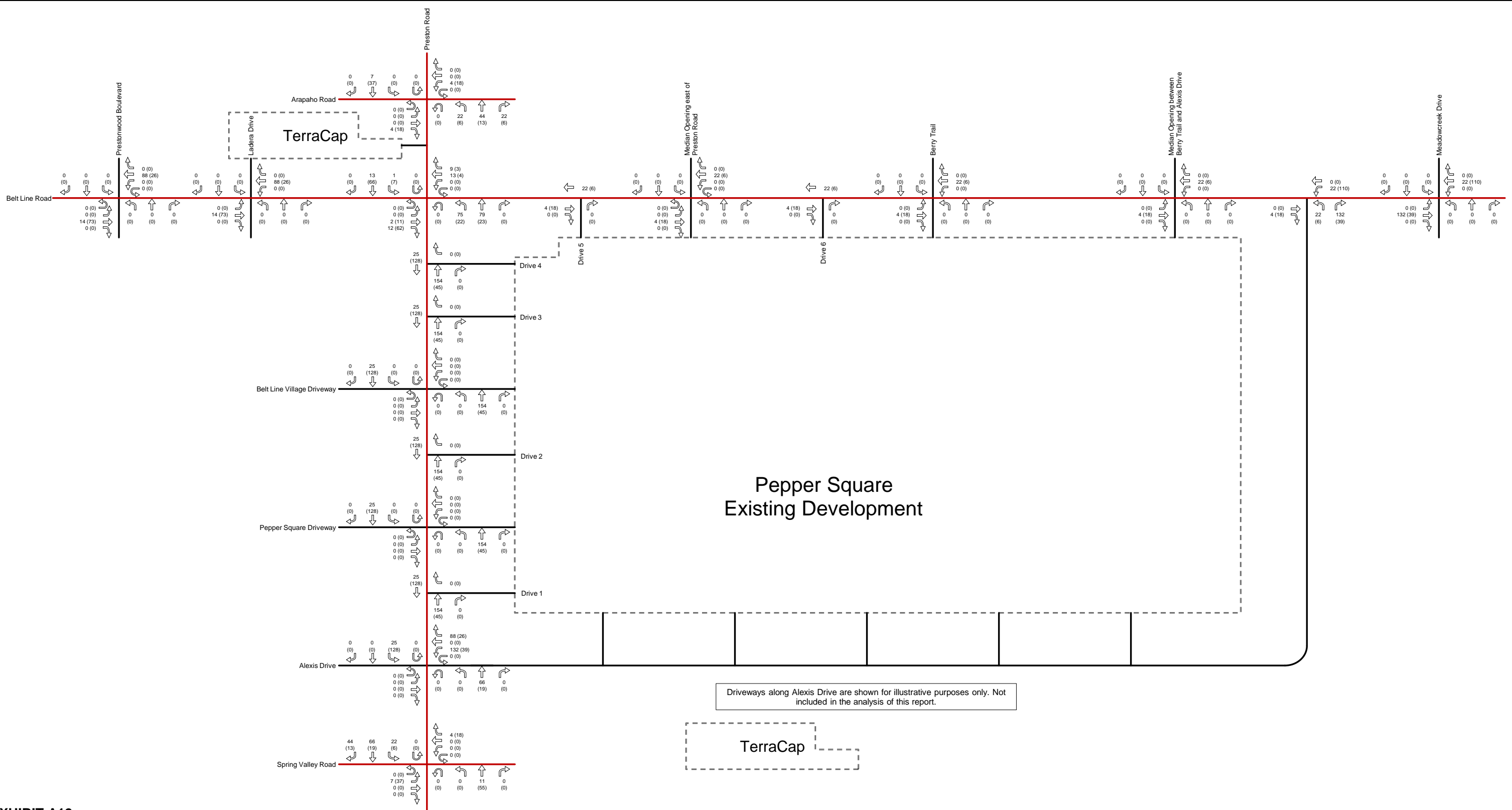

**EXHIBIT A12**  
 Site-Generated Traffic Volumes: Tonti Alexis (2033)  
 Pepper Square - Dallas, Texas



**LEGEND:**  
 X (Y)  
 X = Weekday AM Peak Hour Turning Movements  
 Y = Weekday PM Peak Hour Turning Movements  
 Volumes may not sum from point to point due to rounding  
 and presence of smaller driveways not included in analysis.



Not To Scale



## **TIA Exhibits for Theoretical Removal of a Driveway to Preston Road**

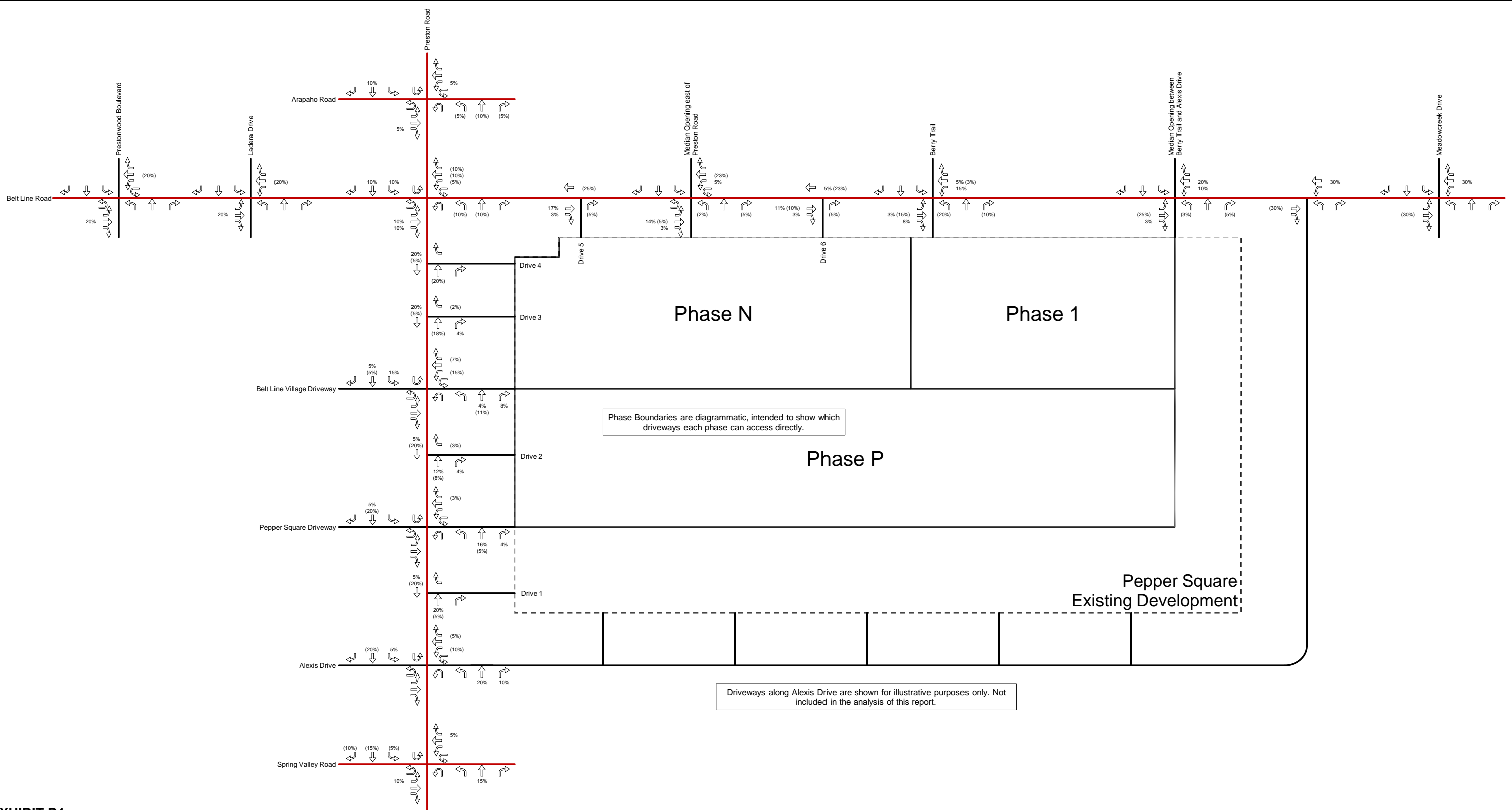

Phase boundaries are diagrammatic, intended to show which driveways each phase can access directly.

Driveways along Alexis Drive are shown for illustrative purposes only. Not included in the analysis of this report.

**EXHIBIT B1**  
 Trip Distribution and Traffic Assignment- Phase 1, P, and N with Drive 4 Removed  
 Pepper Square - Dallas, Texas



**LEGEND:**  
 X% (Y%)  
 X% = Percentage of Inbound Site-Generated Traffic  
 (Y%) = Percentage of Outbound Site-Generated Traffic



Not To Scale



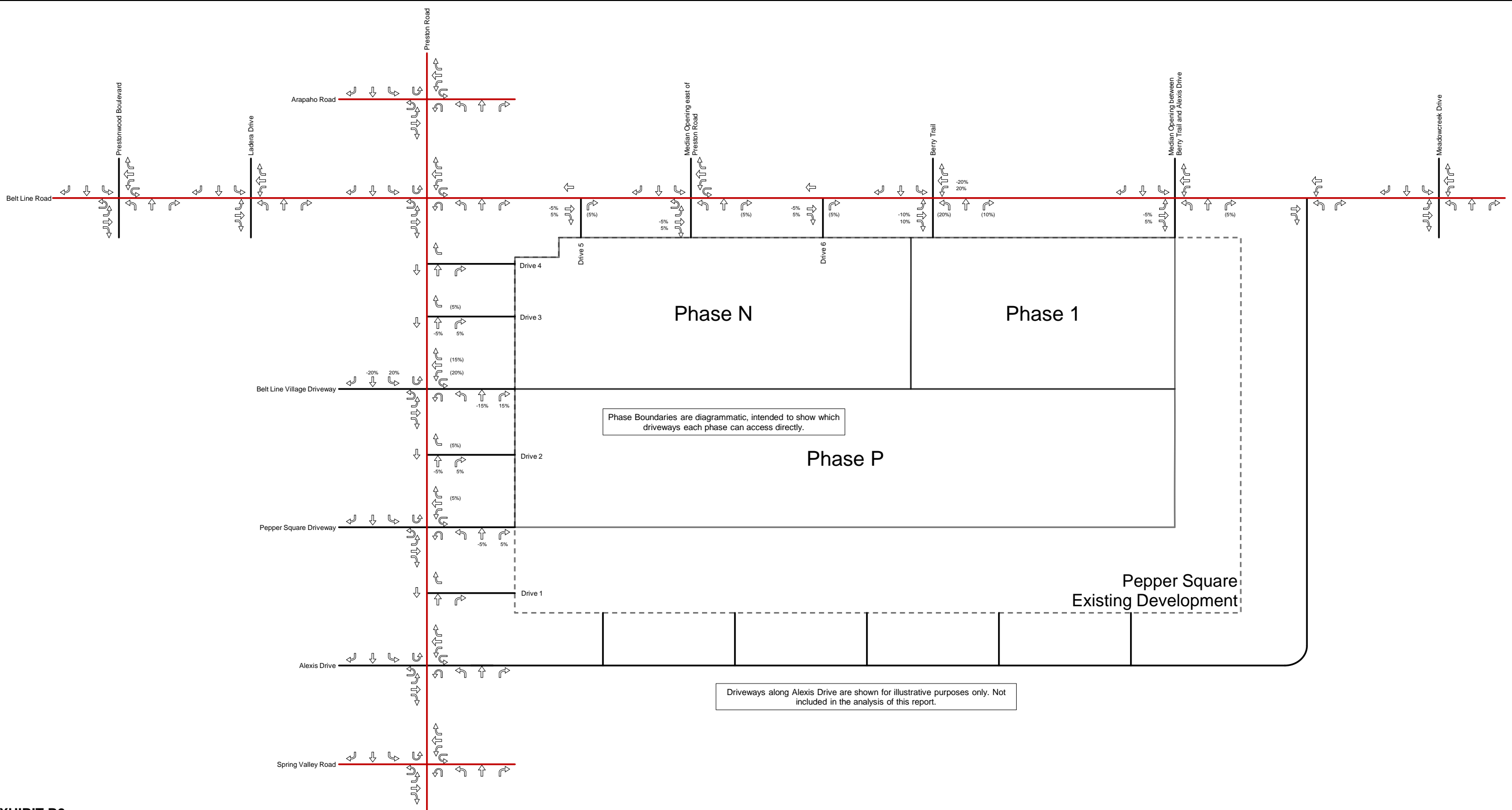

**EXHIBIT B2**  
 Trip Distribution and Traffic Assignment- Phase 1, P, and N with Drive 4 Removed, Pass-By Trips  
 Pepper Square - Dallas, Texas



**LEGEND:**  
 X% (Y%)  
 X% = Percentage of Inbound Site-Generated Traffic  
 Y% = Percentage of Outbound Site-Generated Traffic



Not To Scale

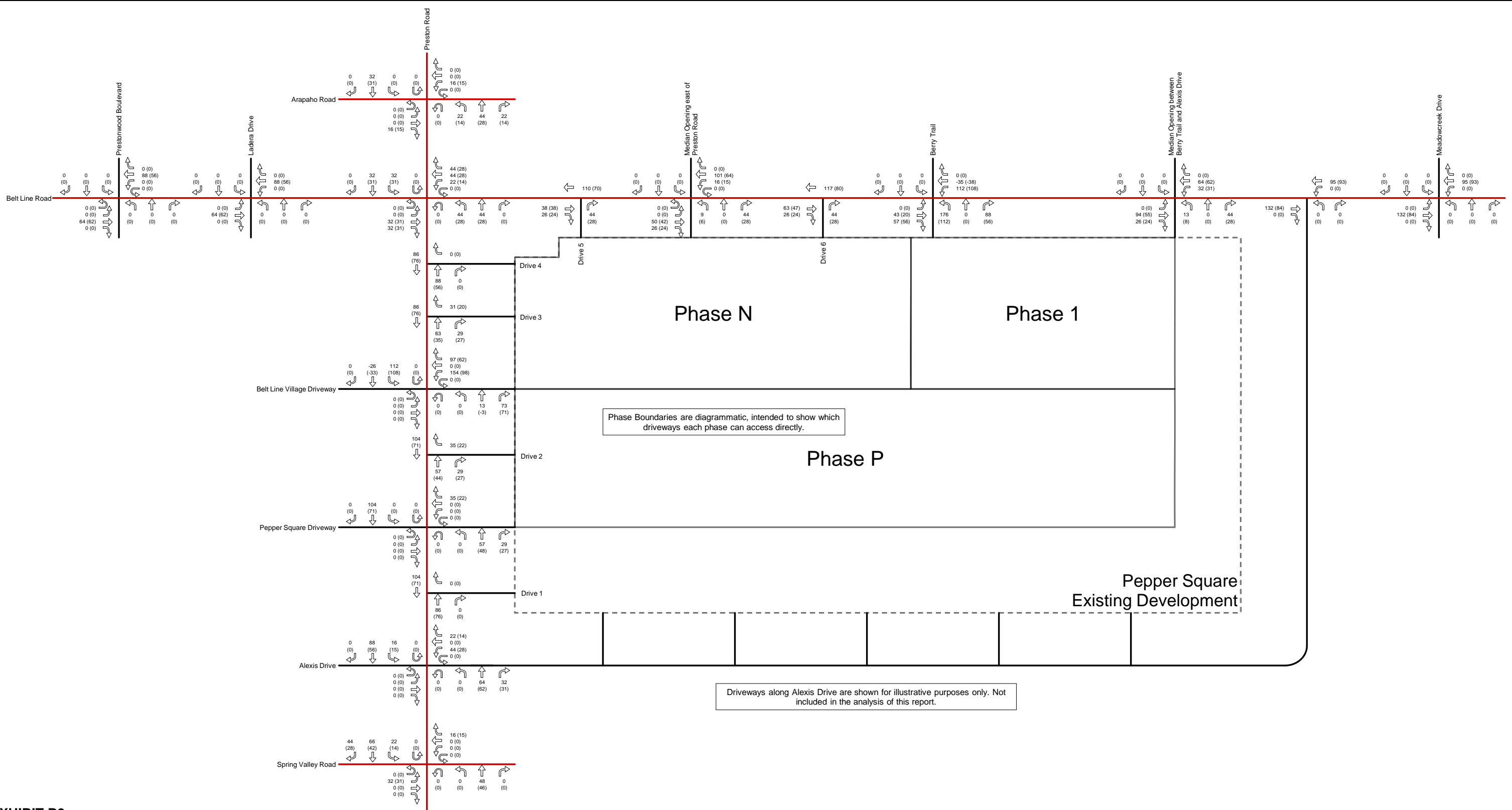

**EXHIBIT B3**  
 Site-Generated Traffic Volumes- Phase 1, P, and N with Drive 4 Removed, Total  
 Pepper Square - Dallas, Texas



**LEGEND:**  
 X (Y)  
 X = Weekday AM Peak Hour Turning Movements  
 Y = Weekday PM Peak Hour Turning Movements  
 Volumes may not sum from point to point due to rounding  
 and presence of smaller driveways not included in analysis.



Not To Scale

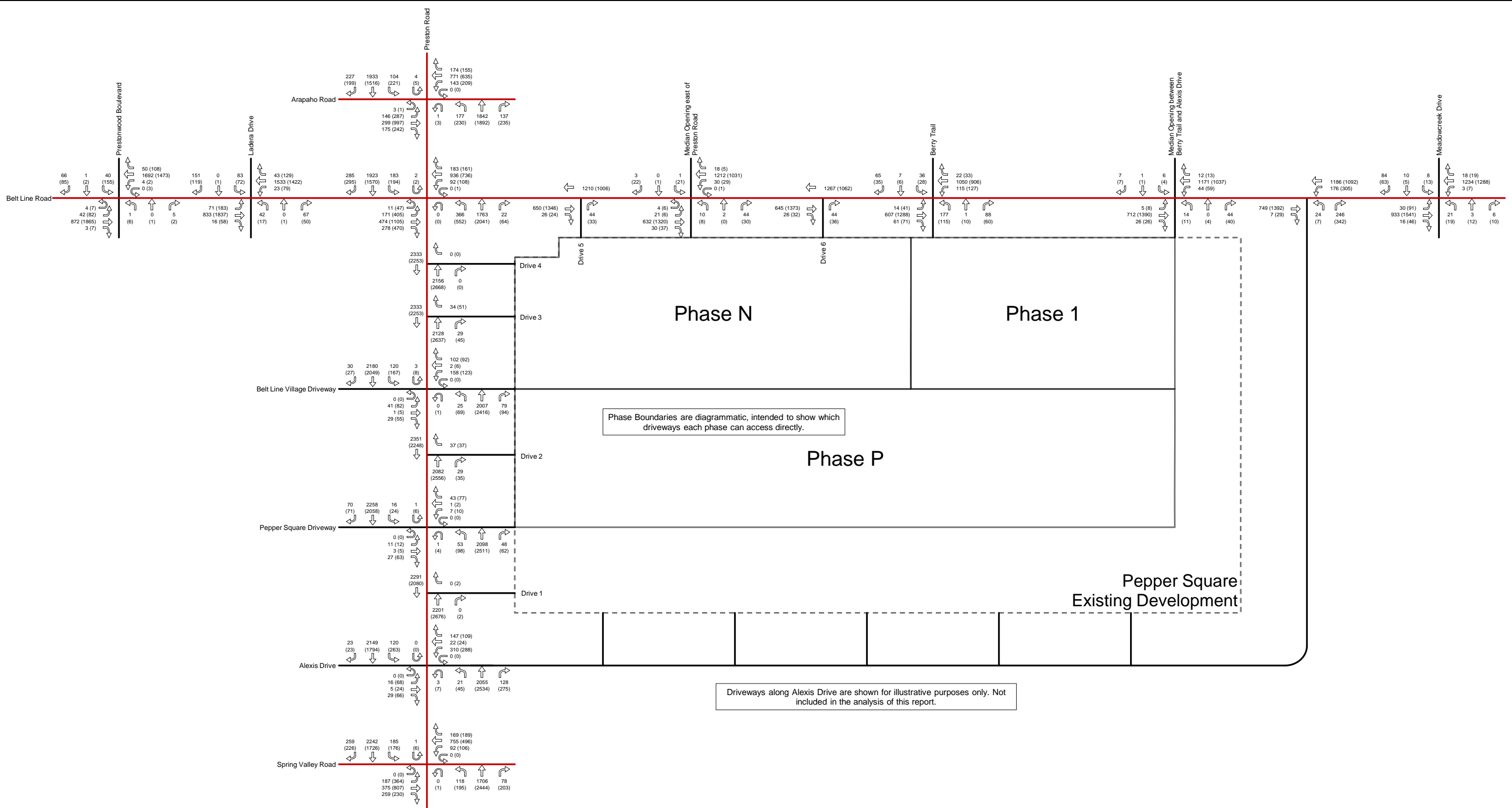

**EXHIBIT B4**  
 2033 Background Plus Site-Generated Traffic Volumes- Phase 1, P, and N with Drive 4 Removed  
 Pepper Square - Dallas, Texas



**LEGEND:**  
 X (Y)  
 X = Weekday AM Peak Hour Turning Movements  
 Y = Weekday PM Peak Hour Turning Movements  
 Volumes may not sum from point to point due to rounding  
 and presence of smaller driveways not included in analysis.



Not To Scale

## Traffic Counts and Historical Data

### Pepper Square - Dallas, Texas

Historical Link Volumes and Growth Rates

Belt Line Road (east of Preston)						
Record	Year	Link Start	Link End	Source	24-Hour Volume	Annual Growth Rate
1	2014	Preston Road	Berry Trail	TxDOT	25,067	-
2	2019	Preston Road	Berry Trail	TxDOT	23,863	-1.0%
3	2021	Preston Road	Berry Trail	KHA	22,233	-3.5%
4A	2022 (Wed)	Preston Road	Berry Trail	KHA	23,841	N/A
4B	2022 (Thu)	Preston Road	Berry Trail	KHA	24,765	N/A
4	2022	Preston Road	Berry Trail	KHA	24,303	9.3%
Average Growth 2014 - 2019:						-1.0%
Average Growth 2014 - 2022:						-0.9%

Belt Line Road (west of Preston)						
Record	Year	Link Start	Link End	Source	24-Hour Volume	Annual Growth Rate
1	2013	Ladera Drive	Preston Road	TxDOT	39,266	-
2	2014	Ladera Drive	Preston Road	TxDOT	35,047	-10.7%
3	2015	Ladera Drive	Preston Road	TxDOT	39,871	13.8%
4	2016	Ladera Drive	Preston Road	TxDOT	35,694	-10.5%
5	2017	Ladera Drive	Preston Road	TxDOT	37,112	4.0%
6	2018	Ladera Drive	Preston Road	TxDOT	38,940	4.9%
7	2021	Ladera Drive	Preston Road	KHA	34,170	-4.3%
8A	2022 (Wed)	Ladera Drive	Preston Road	KHA	35,785	N/A
8B	2022 (Thu)	Ladera Drive	Preston Road	KHA	36,564	N/A
8	2022	Ladera Drive	Preston Road	KHA	36,175	5.9%
Average Growth 2013 - 2018:						0.1%
Average Growth 2013 - 2022:						-0.8%

Preston Road (south of Belt Line Road)						
Record	Year	Link Start	Link End	Source	24-Hour Volume	Annual Growth Rate
1	2014	Alexis Drive	Belt Line Road	TxDOT	48,439	-
2	2021	Alexis Drive	Belt Line Road	KHA	47,957	-0.1%
3A	2022 (Wed)	Alexis Drive	Belt Line Road	KHA	50,014	N/A
3B	2022 (Thu)	Alexis Drive	Belt Line Road	KHA	50,635	N/A
3	2022	Alexis Drive	Belt Line Road	KHA	50,325	4.9%
Average Growth 2014 - 2022:						0.2%

Preston Road (north of Belt Line Road)						
Record	Year	Link Start	Link End	Source	24-Hour Volume	Annual Growth Rate
1	2014	Belt Line Road	Berry Trail	TxDOT	45,760	-
2	2021	Belt Line Road	Berry Trail	KHA	46,199	0.1%
Average Growth 2014 - 2021:						0.1%

0.5% annual growth factor applied

**EB Belt Line Road East of Preston Road**

Date Began:  
8/24/2022

TIME	0:00	0:15	0:30	0:45	Total
0:00	35	35	41	27	138
1:00	22	14	19	6	61
2:00	18	10	15	5	48
3:00	6	6	7	8	27
4:00	6	8	12	9	35
5:00	15	21	22	30	88
6:00	43	52	33	66	194
7:00	80	114	119	147	460
8:00	157	120	126	142	545
9:00	118	98	106	123	445
10:00	110	135	107	131	483
11:00	143	147	153	185	628
12:00	193	165	175	198	731
13:00	193	186	197	201	777
14:00	170	200	222	225	817
15:00	208	243	251	269	971
16:00	263	329	313	331	1236
17:00	317	329	323	290	1259
18:00	253	302	251	199	1005
19:00	187	197	177	173	734
20:00	158	154	148	132	592
21:00	110	121	126	91	448
22:00	101	93	101	68	363
23:00	64	45	48	46	203

TOTAL: 12288

The A.M. peak hour from 11:45 to 12:44 is 718
The P.M. peak hour from 16:45 to 17:44 is 1300

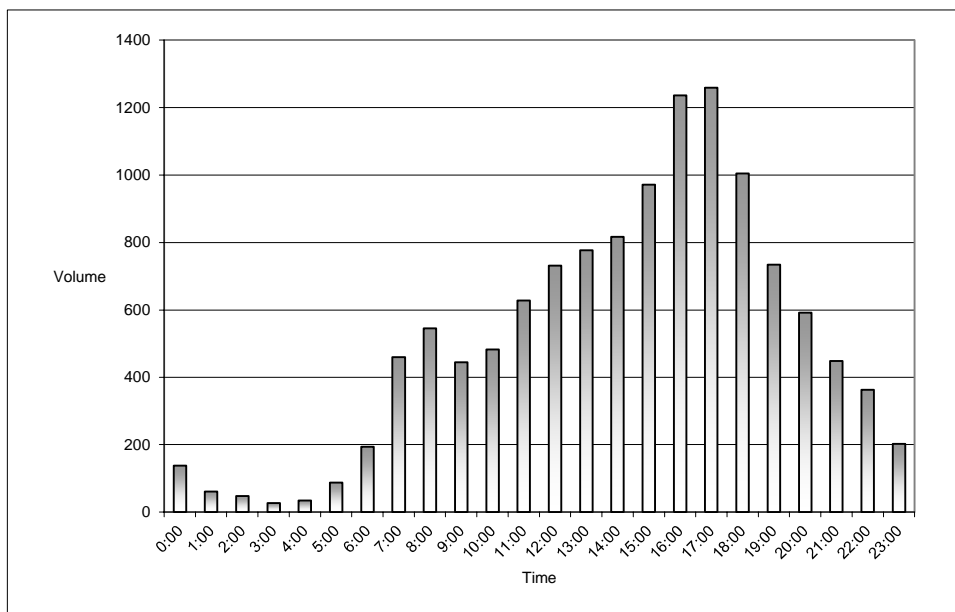

**WB Belt Line Road East of Preston Road**

Date Began:  
8/24/2022

TIME	0:00	0:15	0:30	0:45	Total
0:00	18	15	9	7	49
1:00	9	12	7	6	34
2:00	7	7	5	8	27
3:00	6	8	8	7	29
4:00	7	12	34	29	82
5:00	35	44	64	58	201
6:00	72	110	132	180	494
7:00	186	268	279	332	1065
8:00	340	286	284	275	1185
9:00	230	187	161	208	786
10:00	164	133	128	138	563
11:00	131	170	181	205	687
12:00	153	182	142	169	646
13:00	151	153	148	156	608
14:00	151	156	168	167	642
15:00	176	194	192	210	772
16:00	214	165	186	209	774
17:00	178	200	194	206	778
18:00	194	186	156	156	692
19:00	129	141	134	118	522
20:00	98	94	102	98	392
21:00	76	62	71	50	259
22:00	58	36	51	32	177
23:00	29	22	16	22	89

TOTAL: 11553

The A.M. peak hour from 7:45 to 8:44 is 1242
The P.M. peak hour from 15:15 to 16:14 is 810

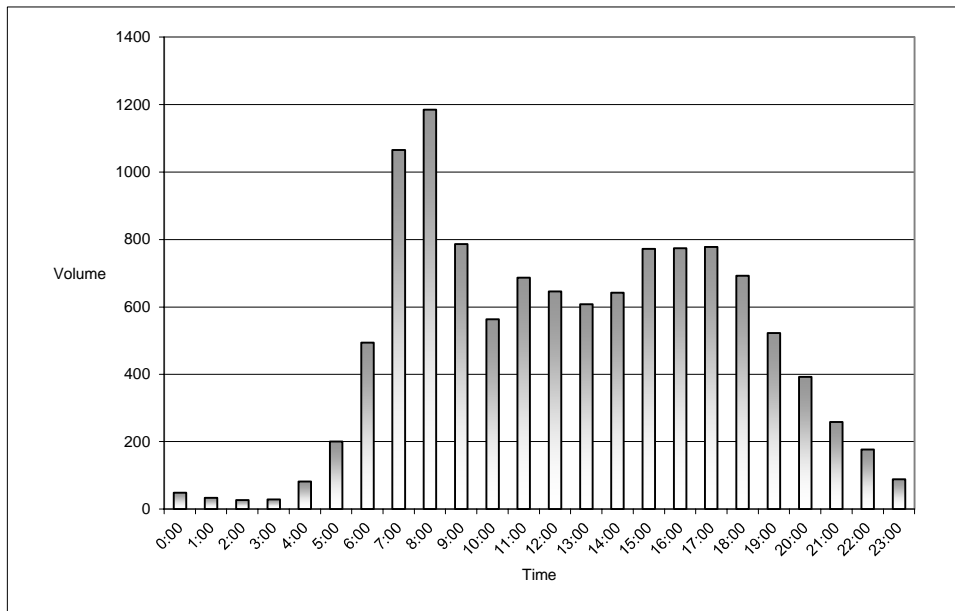

**EB Belt Line Road East of Preston Road**

Date Began:  
8/25/2022

TIME	0:00	0:15	0:30	0:45	Total
0:00	41	35	29	32	137
1:00	10	22	11	9	52
2:00	7	16	12	11	46
3:00	7	10	6	11	34
4:00	3	9	15	9	36
5:00	17	16	26	15	74
6:00	43	40	52	58	193
7:00	87	122	160	144	513
8:00	147	139	133	124	543
9:00	131	138	137	130	536
10:00	108	142	140	158	548
11:00	130	160	158	179	627
12:00	191	234	202	258	885
13:00	230	173	218	210	831
14:00	237	195	224	257	913
15:00	236	242	280	263	1021
16:00	242	317	288	286	1133
17:00	326	336	336	338	1336
18:00	255	288	245	183	971
19:00	196	210	184	179	769
20:00	143	188	144	147	622
21:00	137	140	131	127	535
22:00	122	95	85	89	391
23:00	70	75	51	46	242

TOTAL: 12988

The A.M. peak hour from 11:45 to 12:44 is 806
The P.M. peak hour from 17:00 to 17:59 is 1336

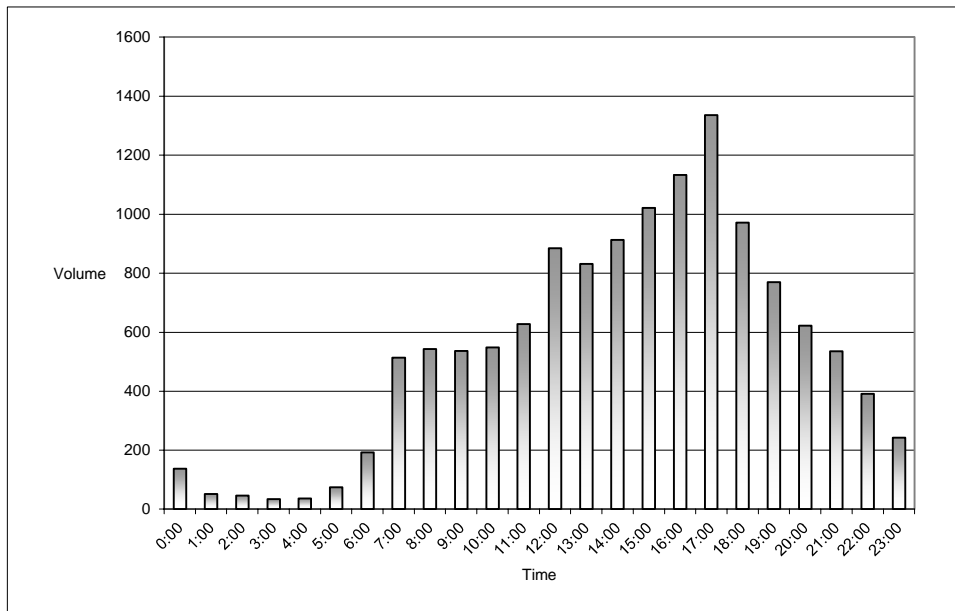

**WB Belt Line Road East of Preston Road**

Date Began:  
8/25/2022

TIME	0:00	0:15	0:30	0:45	Total
0:00	18	12	13	12	55
1:00	10	8	7	9	34
2:00	10	7	8	5	30
3:00	5	6	6	8	25
4:00	7	13	32	25	77
5:00	36	40	64	78	218
6:00	72	106	142	181	501
7:00	196	245	315	342	1098
8:00	305	295	290	280	1170
9:00	226	193	168	200	787
10:00	169	174	144	158	645
11:00	151	140	162	200	653
12:00	174	170	144	160	648
13:00	138	174	146	172	630
14:00	165	153	151	156	625
15:00	176	192	189	212	769
16:00	202	203	172	216	793
17:00	181	187	214	197	779
18:00	186	182	176	146	690
19:00	150	155	126	126	557
20:00	91	105	99	84	379
21:00	80	70	74	73	297
22:00	48	48	60	45	201
23:00	40	34	17	25	116

TOTAL: 11777

The A.M. peak hour from 7:30 to 8:29 is 1257
The P.M. peak hour from 15:30 to 16:29 is 806

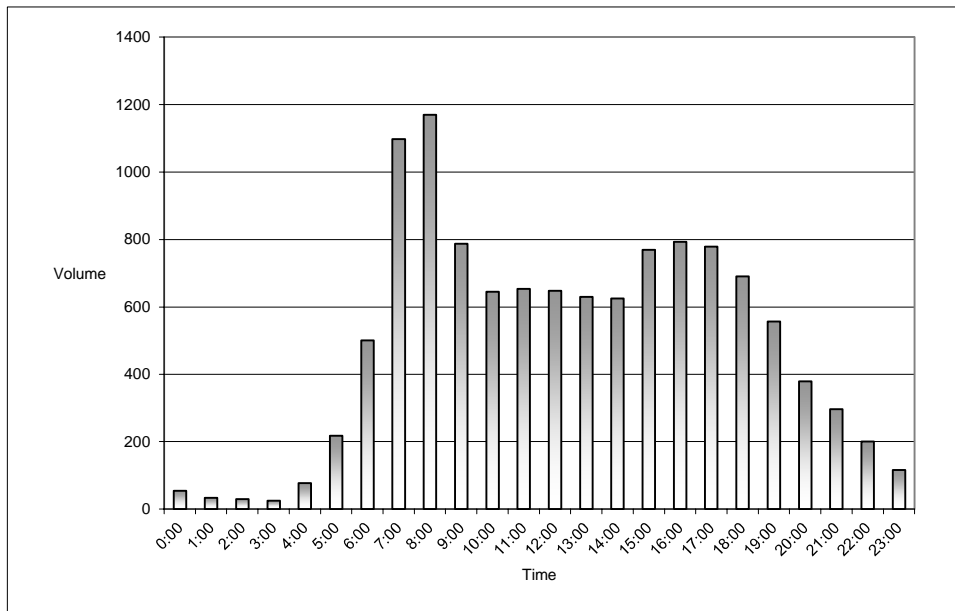



**NB Preston Road South of Belt Line Road**

Date Began:  
8/24/2022

TIME	0:00	0:15	0:30	0:45	Total
0:00	54	54	48	46	202
1:00	53	31	39	34	157
2:00	26	30	20	22	98
3:00	22	21	23	22	88
4:00	22	34	46	59	161
5:00	86	159	178	166	589
6:00	186	262	272	240	960
7:00	282	342	386	404	1414
8:00	406	404	352	394	1556
9:00	337	356	304	338	1335
10:00	310	309	312	313	1244
11:00	300	282	311	318	1211
12:00	320	340	306	346	1312
13:00	302	308	322	340	1272
14:00	322	400	326	410	1458
15:00	378	410	412	444	1644
16:00	477	576	522	578	2153
17:00	555	569	572	566	2262
18:00	541	517	390	422	1870
19:00	349	356	296	301	1302
20:00	290	234	234	215	973
21:00	224	191	184	168	767
22:00	157	119	96	112	484
23:00	108	118	74	54	354

TOTAL: 24866

The A.M. peak hour from 7:30 to 8:29 is 1600
The P.M. peak hour from 16:45 to 17:44 is 2274

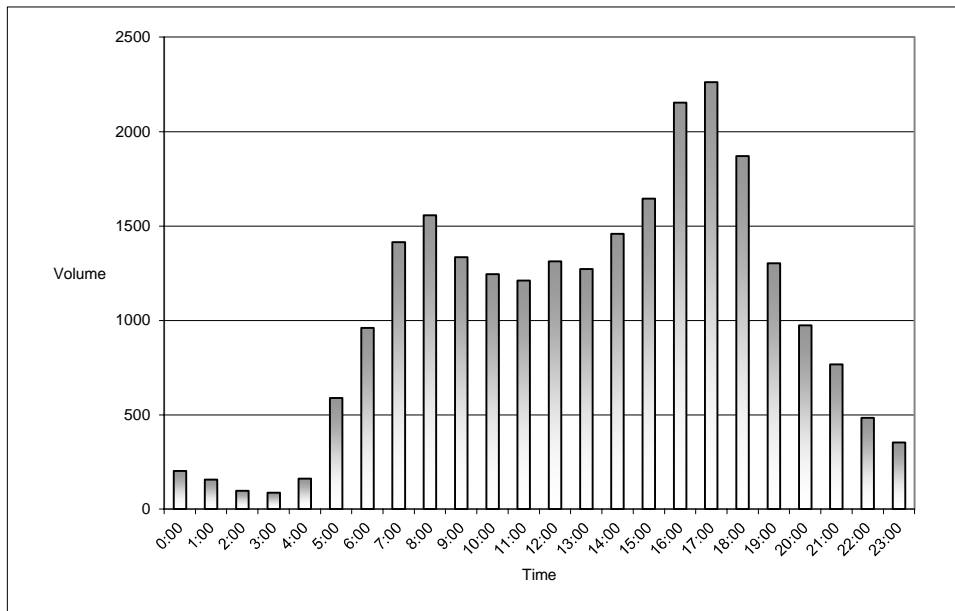

**SB Preston Road South of Belt Line Road**

Date Began:  
8/24/2022

TIME	0:00	0:15	0:30	0:45	Total
0:00	58	42	42	45	187
1:00	32	34	20	26	112
2:00	20	22	26	20	88
3:00	17	18	26	28	89
4:00	21	30	34	54	139
5:00	62	95	130	117	404
6:00	156	217	278	306	957
7:00	359	528	548	500	1935
8:00	572	531	538	490	2131
9:00	398	374	356	352	1480
10:00	282	312	309	344	1247
11:00	292	298	320	330	1240
12:00	367	338	346	334	1385
13:00	298	382	240	305	1225
14:00	325	400	385	382	1492
15:00	402	421	424	412	1659
16:00	449	437	438	478	1802
17:00	435	476	486	466	1863
18:00	489	448	375	417	1729
19:00	378	324	286	294	1282
20:00	276	256	261	248	1041
21:00	227	200	188	190	805
22:00	148	134	124	126	532
23:00	96	106	62	60	324

TOTAL: 25148

The A.M. peak hour from 7:30 to 8:29 is 2151
The P.M. peak hour from 17:15 to 18:14 is 1917

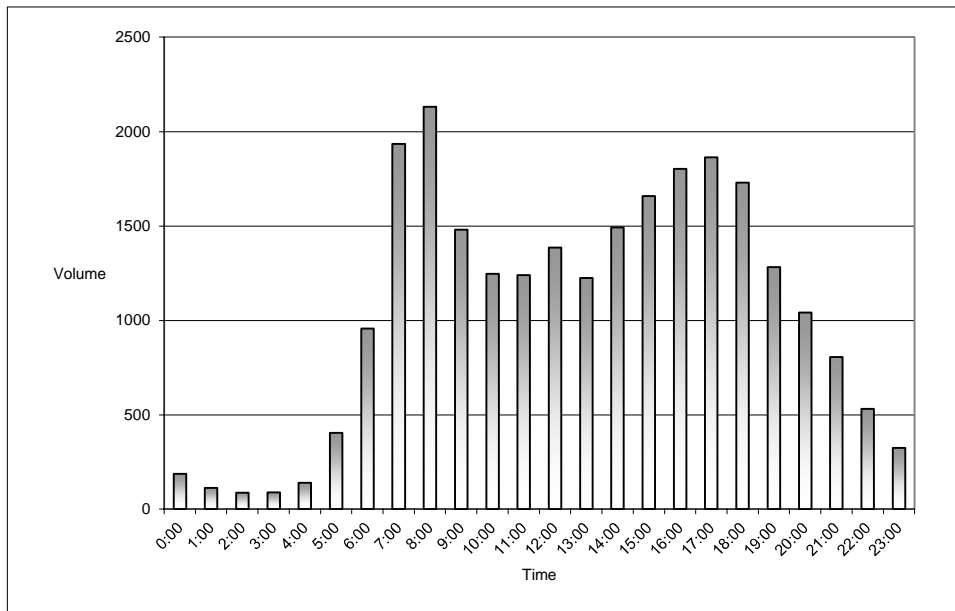

**NB Preston Road South of Belt Line Road**

Date Began:  
8/25/2022

TIME	0:00	0:15	0:30	0:45	Total
0:00	58	52	36	42	188
1:00	42	37	36	24	139
2:00	22	32	17	23	94
3:00	18	24	14	28	84
4:00	26	32	30	57	145
5:00	94	158	178	212	642
6:00	200	270	212	241	923
7:00	263	307	348	402	1320
8:00	370	380	382	376	1508
9:00	319	312	313	356	1300
10:00	349	332	299	298	1278
11:00	332	290	320	343	1285
12:00	274	360	314	326	1274
13:00	322	336	322	336	1316
14:00	336	338	315	365	1354
15:00	350	442	410	394	1596
16:00	413	554	514	578	2059
17:00	540	544	591	552	2227
18:00	519	496	410	386	1811
19:00	325	344	284	304	1257
20:00	276	254	277	200	1007
21:00	218	204	183	166	771
22:00	152	136	122	126	536
23:00	128	86	84	90	388

TOTAL: 24502

The A.M. peak hour from 7:45 to 8:44 is 1534
The P.M. peak hour from 16:45 to 17:44 is 2253

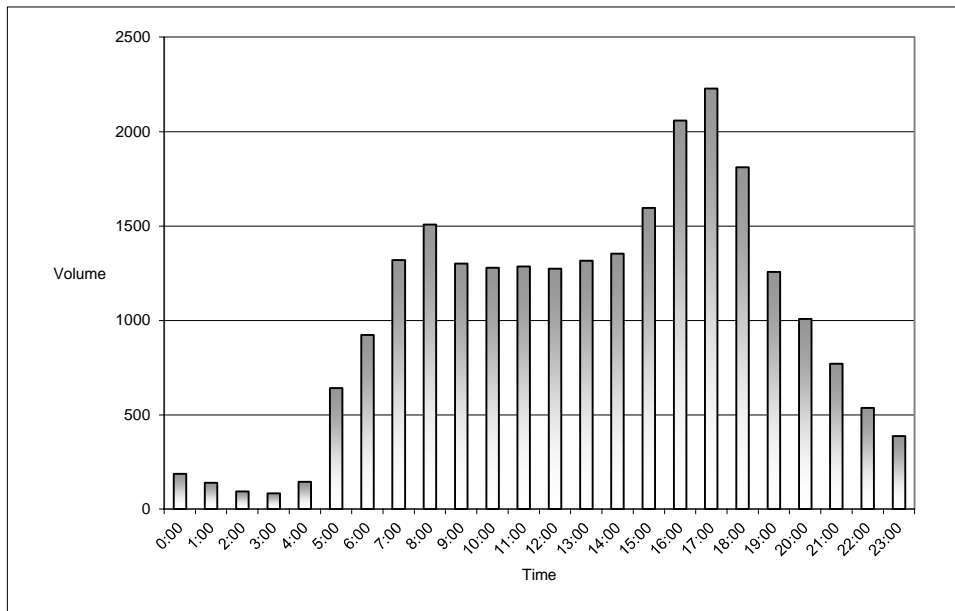

**SB Preston Road South of Belt Line Road**

Date Began:  
8/25/2022

TIME	0:00	0:15	0:30	0:45	Total
0:00	66	52	35	40	193
1:00	34	21	26	30	111
2:00	20	18	22	18	78
3:00	28	17	20	25	90
4:00	28	42	44	56	170
5:00	74	94	127	107	402
6:00	141	203	260	288	892
7:00	374	520	560	529	1983
8:00	540	518	565	416	2039
9:00	446	380	366	332	1524
10:00	319	356	308	286	1269
11:00	339	352	433	355	1479
12:00	360	389	437	444	1630
13:00	413	382	404	332	1531
14:00	344	370	384	372	1470
15:00	414	446	426	434	1720
16:00	474	479	406	471	1830
17:00	440	476	528	415	1859
18:00	445	459	384	412	1700
19:00	402	334	316	266	1318
20:00	254	278	284	242	1058
21:00	204	196	220	180	800
22:00	180	170	131	139	620
23:00	110	99	74	84	367

TOTAL: 26133

The A.M. peak hour from 7:45 to 8:44 is 2152
The P.M. peak hour from 16:45 to 17:44 is 1915

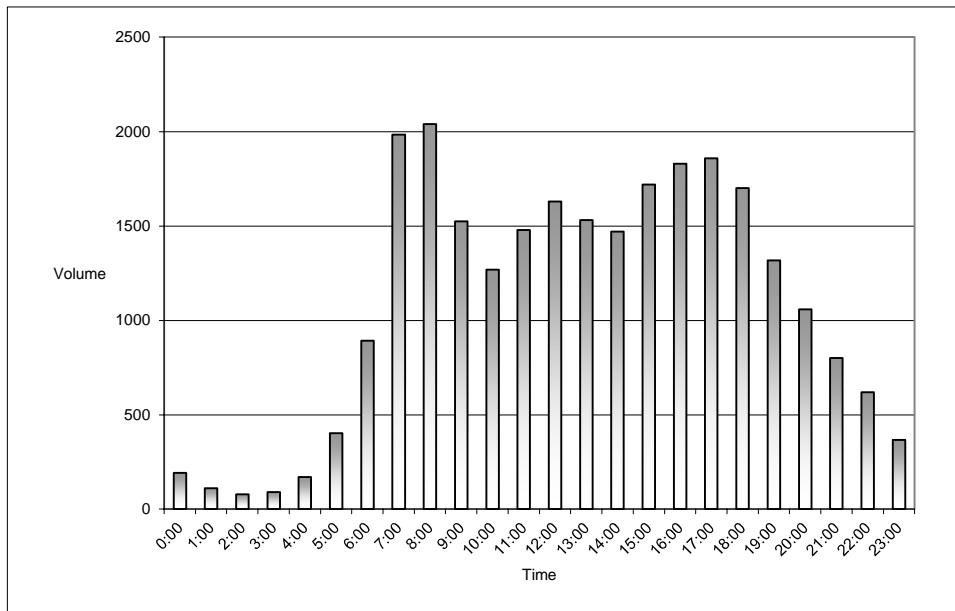

**EB Belt Line Road West of Preston Road**

Date Began:  
8/24/2022

TIME	0:00	0:15	0:30	0:45	Total
0:00	50	66	46	42	204
1:00	34	22	28	12	96
2:00	20	16	15	10	61
3:00	8	8	12	10	38
4:00	8	16	14	18	56
5:00	22	40	36	45	143
6:00	65	71	84	117	337
7:00	132	177	177	209	695
8:00	256	184	250	196	886
9:00	200	175	194	192	761
10:00	156	186	188	170	700
11:00	228	235	254	250	967
12:00	286	254	270	278	1088
13:00	259	310	300	270	1139
14:00	256	308	288	302	1154
15:00	328	309	346	336	1319
16:00	401	384	422	425	1632
17:00	424	456	438	405	1723
18:00	402	354	342	313	1411
19:00	256	270	282	244	1052
20:00	262	217	222	202	903
21:00	188	181	171	140	680
22:00	163	114	118	82	477
23:00	78	68	70	46	262

TOTAL: 17784

The A.M. peak hour from 11:45 to 12:44 is 1060
The P.M. peak hour from 16:45 to 17:44 is 1743

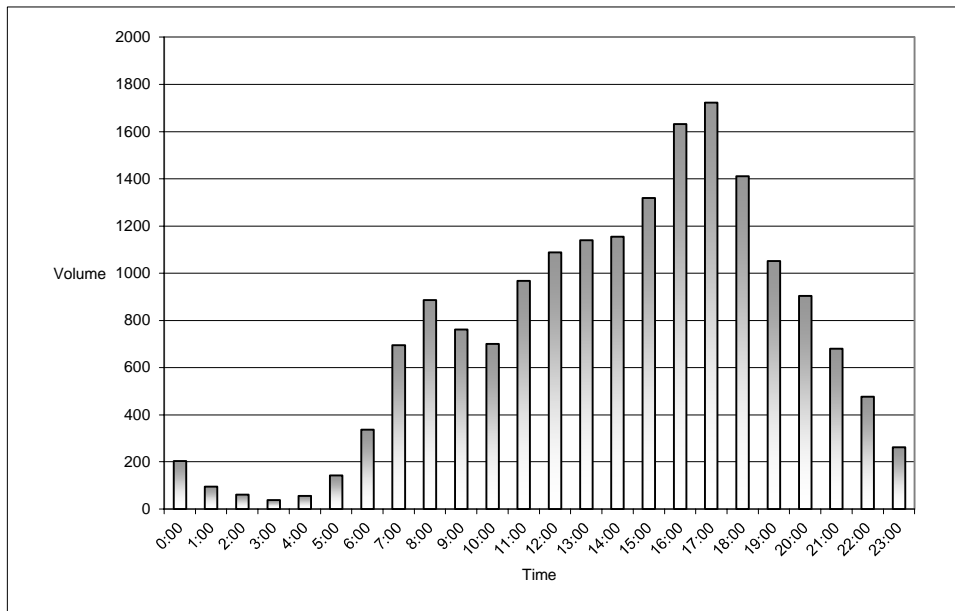

**WB Belt Line Road West of Preston Road**

Date Began:  
8/24/2022

TIME	0:00	0:15	0:30	0:45	Total
0:00	30	20	25	23	98
1:00	28	20	19	12	79
2:00	24	19	9	16	68
3:00	4	10	11	15	40
4:00	16	17	42	42	117
5:00	47	61	100	82	290
6:00	84	135	172	240	631
7:00	260	312	383	416	1371
8:00	448	406	357	377	1588
9:00	296	241	218	276	1031
10:00	249	212	188	219	868
11:00	239	250	256	311	1056
12:00	284	295	274	313	1166
13:00	285	252	257	280	1074
14:00	274	279	264	270	1087
15:00	257	276	285	310	1128
16:00	299	318	276	290	1183
17:00	329	333	317	334	1313
18:00	310	346	300	237	1193
19:00	245	246	230	208	929
20:00	160	175	173	168	676
21:00	156	117	140	96	509
22:00	102	72	76	76	326
23:00	56	53	40	31	180

TOTAL: 18001

The A.M. peak hour from 7:30 to 8:29 is 1653
The P.M. peak hour from 17:00 to 17:59 is 1313

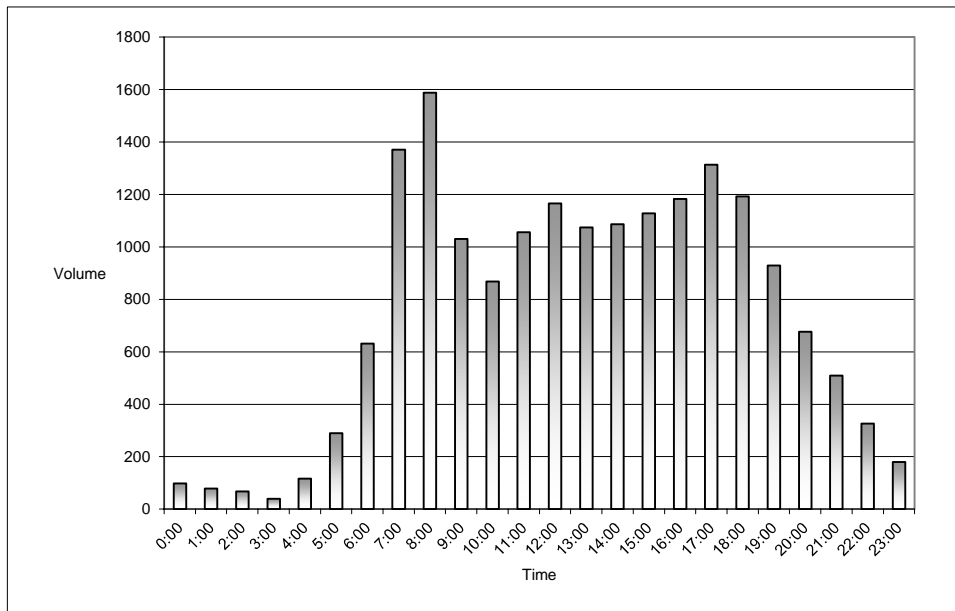

**EB Belt Line Road West of Preston Road**

Date Began:  
8/25/2022

TIME	0:00	0:15	0:30	0:45	Total
0:00	48	51	50	37	186
1:00	22	25	16	16	79
2:00	22	15	17	17	71
3:00	14	12	10	12	48
4:00	12	9	18	14	53
5:00	26	32	38	42	138
6:00	52	66	71	118	307
7:00	112	198	190	219	719
8:00	227	174	204	194	799
9:00	173	194	206	190	763
10:00	164	204	212	193	773
11:00	206	242	272	258	978
12:00	296	312	302	360	1270
13:00	343	274	342	280	1239
14:00	322	294	298	338	1252
15:00	311	352	388	382	1433
16:00	368	390	382	402	1542
17:00	397	434	466	408	1705
18:00	376	360	314	308	1358
19:00	310	268	270	254	1102
20:00	234	270	234	214	952
21:00	213	191	196	182	782
22:00	160	128	126	95	509
23:00	102	107	80	66	355

TOTAL: 18413

The A.M. peak hour from 11:45 to 12:44 is 1168
The P.M. peak hour from 17:00 to 17:59 is 1705

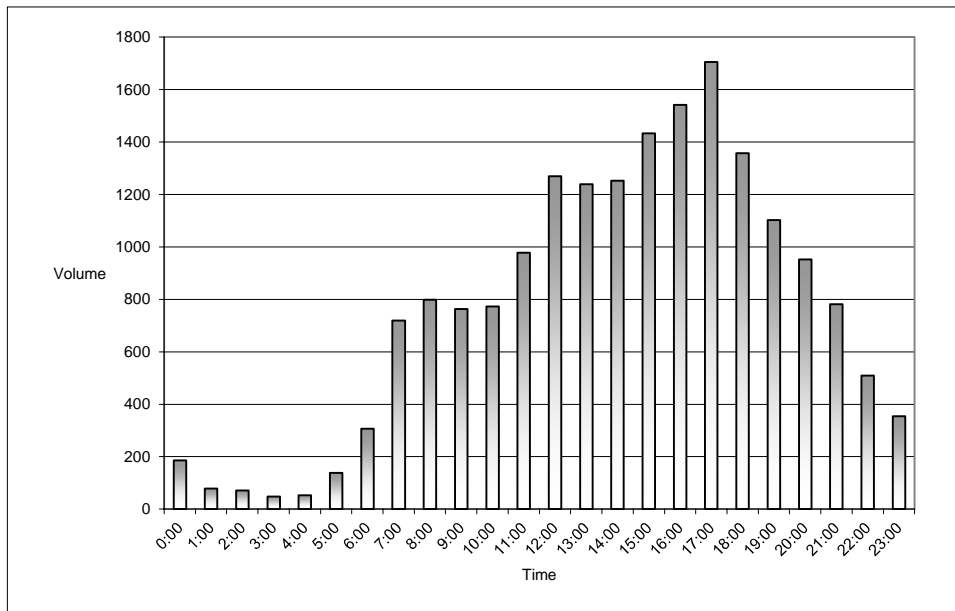

**WB Belt Line Road West of Preston Road**

Date Began:  
8/25/2022

TIME	0:00	0:15	0:30	0:45	Total
0:00	27	20	19	19	85
1:00	24	17	13	19	73
2:00	18	18	14	12	62
3:00	10	7	8	15	40
4:00	8	22	32	35	97
5:00	51	57	82	96	286
6:00	92	131	181	215	619
7:00	260	313	404	448	1425
8:00	418	426	373	341	1558
9:00	331	251	243	256	1081
10:00	253	237	227	223	940
11:00	225	244	252	288	1009
12:00	287	276	263	265	1091
13:00	252	277	246	278	1053
14:00	286	249	293	270	1098
15:00	249	276	301	319	1145
16:00	280	308	292	315	1195
17:00	310	329	289	353	1281
18:00	314	288	322	261	1185
19:00	254	248	217	210	929
20:00	204	192	192	135	723
21:00	154	141	125	134	554
22:00	118	87	85	74	364
23:00	84	66	49	59	258

TOTAL: 18151

The A.M. peak hour from 7:30 to 8:29 is 1696
The P.M. peak hour from 17:15 to 18:14 is 1285

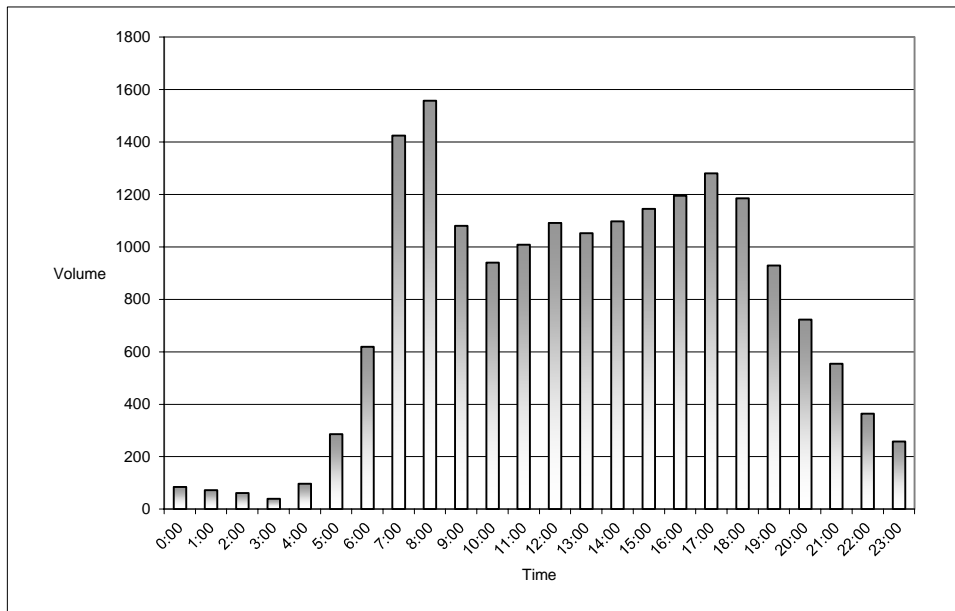



# 1. Belt Line Road at Prestonwood Boulevard - TMC

Wed May 12, 2021

Full Length (7 AM-9 AM, 4:30 PM-6:30 PM)

All Classes (Lights, Articulated Trucks, Buses and Single-Unit Trucks, Pedestrians, Bicycles on Crosswalk)

All Movements

ID: 835140, Location: 32.954086, -96.813727



Provided by: C. J. Hensch & Associates Inc.  
5215 Sycamore Ave.,  
Pasadena, TX, 77503, US

Leg Direction	Belt Line Road Eastbound						Belt Line Road Westbound						Lake Forest Drive Northbound						Prestonwood Boulevard Southbound						Int
Time	L	T	R	U	App	Ped*	L	T	R	U	App	Ped*	L	T	R	U	App	Ped*	L	T	R	U	App	Ped*	
2021-05-12 7:00AM	1	107	0	0	108	0	1	174	6	0	181	0	1	0	0	0	1	1	10	0	7	0	17	0	307
7:15AM	5	171	1	1	178	0	0	230	11	0	241	0	1	0	5	0	6	0	15	0	16	0	31	0	456
7:30AM	14	177	0	1	192	0	0	344	11	0	355	0	0	0	2	0	2	0	5	0	16	0	21	0	570
7:45AM	8	171	0	1	180	1	1	299	16	0	316	0	1	0	1	0	2	1	12	0	17	0	29	0	527
Hourly Total	28	626	1	3	658	1	2	1047	44	0	1093	0	3	0	8	0	11	2	42	0	56	0	98	0	1860
8:00AM	9	178	1	2	190	1	0	307	10	0	317	0	0	0	2	0	2	0	9	0	12	0	21	0	530
8:15AM	9	169	2	0	180	0	3	315	8	0	326	0	0	0	0	0	0	1	12	1	14	0	27	0	533
8:30AM	5	171	0	2	178	1	0	260	7	0	267	0	1	1	0	0	2	0	17	0	19	0	36	0	483
8:45AM	13	165	1	0	179	0	0	301	16	0	317	0	2	0	1	0	3	2	10	1	13	0	24	0	523
Hourly Total	36	683	4	4	727	2	3	1183	41	0	1227	0	3	1	3	0	7	3	48	2	58	0	108	0	2069
4:30PM	12	298	0	2	312	0	4	293	22	0	319	0	2	0	6	0	8	2	41	0	14	0	55	0	694
4:45PM	13	329	1	2	345	0	0	269	17	0	286	0	3	0	1	0	4	0	31	0	14	0	45	0	680
Hourly Total	25	627	1	4	657	0	4	562	39	0	605	0	5	0	7	0	12	2	72	0	28	0	100	0	1374
5:00PM	22	375	1	2	400	0	1	316	19	2	338	1	1	0	1	0	2	0	39	1	21	0	61	0	801
5:15PM	14	355	1	1	371	0	0	269	22	1	292	0	1	0	1	0	2	0	32	0	11	0	43	0	708
5:30PM	20	365	1	3	389	0	0	302	26	0	328	1	2	1	0	0	3	2	39	1	30	1	71	0	791
5:45PM	19	362	4	1	386	0	1	276	30	0	307	0	2	0	0	0	2	0	30	0	14	0	44	0	739
Hourly Total	75	1457	7	7	1546	0	2	1163	97	3	1265	2	6	1	2	0	9	2	140	2	76	1	219	0	3039
6:00PM	25	299	0	2	326	0	2	264	18	0	284	1	2	0	0	0	2	1	37	0	16	0	53	0	665
6:15PM	19	352	3	2	376	0	0	304	16	0	320	1	1	0	1	0	2	1	37	0	18	0	55	0	753
Hourly Total	44	651	3	4	702	0	2	568	34	0	604	2	3	0	1	0	4	2	74	0	34	0	108	0	1418
<b>Total</b>	208	4044	16	22	4290	3	13	4523	255	3	4794	4	20	2	21	0	43	11	376	4	252	1	633	0	9760
<b>% Approach</b>	4.8%	94.3%	0.4%	0.5%	-	-	0.3%	94.3%	5.3%	0.1%	-	-	46.5%	4.7%	48.8%	0%	-	-	59.4%	0.6%	39.8%	0.2%	-	-	-
<b>% Total</b>	2.1%	41.4%	0.2%	0.2%	44.0%	-	0.1%	46.3%	2.6%	0%	49.1%	-	0.2%	0%	0.2%	0%	0.4%	-	3.9%	0%	2.6%	0%	6.5%	-	-
<b>Lights</b>	206	3991	16	22	4235	-	13	4465	251	3	4732	-	20	2	21	0	43	-	374	4	251	1	630	-	9640
<b>% Lights</b>	99.0%	98.7%	100%	100%	98.7%	-	100%	98.7%	98.4%	100%	98.7%	-	100%	100%	100%	0%	100%	-	99.5%	100%	99.6%	100%	99.5%	-	98.8%
<b>Articulated Trucks</b>	0	8	0	0	8	-	0	6	0	0	6	-	0	0	0	0	0	-	1	0	1	0	2	-	16
<b>% Articulated Trucks</b>	0%	0.2%	0%	0%	0.2%	-	0%	0.1%	0%	0%	0.1%	-	0%	0%	0%	0%	0%	-	0.3%	0%	0.4%	0%	0.3%	-	0.2%
<b>Buses and Single-Unit Trucks</b>	2	45	0	0	47	-	0	52	4	0	56	-	0	0	0	0	0	-	1	0	0	0	1	-	104
<b>% Buses and Single-Unit Trucks</b>	1.0%	1.1%	0%	0%	1.1%	-	0%	1.1%	1.6%	0%	1.2%	-	0%	0%	0%	0%	0%	-	0.3%	0%	0%	0%	0.2%	-	1.1%
<b>Pedestrians</b>	-	-	-	-	-	3	-	-	-	-	-	4	-	-	-	-	-	9	-	-	-	-	-	0	
<b>% Pedestrians</b>	-	-	-	-	-	100%	-	-	-	-	-	100%	-	-	-	-	-	81.8%	-	-	-	-	-	-	
<b>Bicycles on Crosswalk</b>	-	-	-	-	-	0	-	-	-	-	-	0	-	-	-	-	-	2	-	-	-	-	-	0	
<b>% Bicycles on Crosswalk</b>	-	-	-	-	-	0%	-	-	-	-	-	0%	-	-	-	-	-	18.2%	-	-	-	-	-	-	

\*Pedestrians and Bicycles on Crosswalk. L: Left, R: Right, T: Thru, U: U-Turn

1. Belt Line Road at Prestonwood Boulevard - TMC

Wed May 12, 2021

AM Peak (7:30 AM - 8:30 AM)

All Classes (Lights, Articulated Trucks, Buses and Single-Unit Trucks, Pedestrians, Bicycles on Crosswalk)

All Movements

ID: 835140, Location: 32.954086, -96.813727



Provided by: C. J. Hensch & Associates Inc.

5215 Sycamore Ave., Pasadena, TX, 77503, US

Leg Direction	Belt Line Road Eastbound						Belt Line Road Westbound						Lake Forest Drive Northbound						Prestonwood Boulevard Southbound						Int
	L	T	R	U	App	Ped*	L	T	R	U	App	Ped*	L	T	R	U	App	Ped*	L	T	R	U	App	Ped*	
2021-05-12 7:30AM	14	177	0	1	<b>192</b>	0	0	344	11	0	<b>355</b>	0	0	0	2	0	<b>2</b>	0	5	0	16	0	<b>21</b>	0	<b>570</b>
7:45AM	8	171	0	1	<b>180</b>	1	1	299	16	0	<b>316</b>	0	1	0	1	0	<b>2</b>	1	12	0	17	0	<b>29</b>	0	<b>527</b>
8:00AM	9	178	1	2	<b>190</b>	1	0	307	10	0	<b>317</b>	0	0	0	2	0	<b>2</b>	0	9	0	12	0	<b>21</b>	0	<b>530</b>
8:15AM	9	169	2	0	<b>180</b>	0	3	315	8	0	<b>326</b>	0	0	0	0	0	<b>0</b>	1	12	1	14	0	<b>27</b>	0	<b>533</b>
<b>Total</b>	<b>40</b>	<b>695</b>	<b>3</b>	<b>4</b>	<b>742</b>	<b>2</b>	<b>4</b>	<b>1265</b>	<b>45</b>	<b>0</b>	<b>1314</b>	<b>0</b>	<b>1</b>	<b>0</b>	<b>5</b>	<b>0</b>	<b>6</b>	<b>2</b>	<b>38</b>	<b>1</b>	<b>59</b>	<b>0</b>	<b>98</b>	<b>0</b>	<b>2160</b>
<b>% Approach</b>	5.4%	93.7%	0.4%	0.5%	-	-	0.3%	96.3%	3.4%	0%	-	-	16.7%	0%	83.3%	0%	-	-	38.8%	1.0%	60.2%	0%	-	-	-
<b>% Total</b>	1.9%	32.2%	0.1%	0.2%	<b>34.4%</b>	-	0.2%	58.6%	2.1%	0%	<b>60.8%</b>	-	0%	0%	0.2%	0%	<b>0.3%</b>	-	1.8%	0%	2.7%	0%	<b>4.5%</b>	-	-
<b>PHF</b>	0.714	0.976	0.375	0.500	<b>0.966</b>	-	0.333	0.919	0.703	-	<b>0.925</b>	-	0.250	-	0.625	-	<b>0.750</b>	-	0.792	0.250	0.868	-	<b>0.845</b>	-	0.947
<b>Lights</b>	38	677	3	4	<b>722</b>	-	4	1250	42	0	<b>1296</b>	-	1	0	5	0	<b>6</b>	-	36	1	58	0	<b>95</b>	-	2119
<b>% Lights</b>	95.0%	97.4%	100%	100%	<b>97.3%</b>	-	100%	98.8%	93.3%	0%	<b>98.6%</b>	-	100%	0%	100%	0%	<b>100%</b>	-	94.7%	100%	98.3%	0%	<b>96.9%</b>	-	98.1%
<b>Articulated Trucks</b>	0	4	0	0	<b>4</b>	-	0	0	0	0	<b>0</b>	-	0	0	0	0	<b>0</b>	-	1	0	1	0	<b>2</b>	-	6
<b>% Articulated Trucks</b>	0%	0.6%	0%	0%	<b>0.5%</b>	-	0%	0%	0%	0%	<b>0%</b>	-	0%	0%	0%	0%	<b>0%</b>	-	2.6%	0%	1.7%	0%	<b>2.0%</b>	-	0.3%
<b>Buses and Single-Unit Trucks</b>	2	14	0	0	<b>16</b>	-	0	15	3	0	<b>18</b>	-	0	0	0	0	<b>0</b>	-	1	0	0	0	<b>1</b>	-	35
<b>% Buses and Single-Unit Trucks</b>	5.0%	2.0%	0%	0%	<b>2.2%</b>	-	0%	1.2%	6.7%	0%	<b>1.4%</b>	-	0%	0%	0%	0%	<b>0%</b>	-	2.6%	0%	0%	0%	<b>1.0%</b>	-	1.6%
Pedestrians	-	-	-	-	-	2	-	-	-	-	-	0	-	-	-	-	-	1	-	-	-	-	-	0	-
% Pedestrians	-	-	-	-	-	100%	-	-	-	-	-	-	-	-	-	-	-	50.0%	-	-	-	-	-	-	-
Bicycles on Crosswalk	-	-	-	-	-	0	-	-	-	-	-	0	-	-	-	-	-	1	-	-	-	-	-	0	-
% Bicycles on Crosswalk	-	-	-	-	-	0%	-	-	-	-	-	-	-	-	-	-	-	50.0%	-	-	-	-	-	-	-

\*Pedestrians and Bicycles on Crosswalk. L: Left, R: Right, T: Thru, U: U-Turn

1. Belt Line Road at Prestonwood Boulevard - TMC

Wed May 12, 2021

PM Peak (5 PM - 6 PM) - Overall Peak Hour

All Classes (Lights, Articulated Trucks, Buses and Single-Unit Trucks, Pedestrians, Bicycles on Crosswalk)

All Movements

ID: 835140, Location: 32.954086, -96.813727



Provided by: C. J. Hensch & Associates Inc.  
5215 Sycamore Ave.,  
Pasadena, TX, 77503, US

Leg Direction	Belt Line Road Eastbound						Belt Line Road Westbound						Lake Forest Drive Northbound						Prestonwood Boulevard Southbound						
Time	L	T	R	U	App	Ped*	L	T	R	U	App	Ped*	L	T	R	U	App	Ped*	L	T	R	U	App	Ped*	Int
2021-05-12 5:00PM	22	375	1	2	400	0	1	316	19	2	338	1	1	0	1	0	2	0	39	1	21	0	61	0	801
5:15PM	14	355	1	1	371	0	0	269	22	1	292	0	1	0	1	0	2	0	32	0	11	0	43	0	708
5:30PM	20	365	1	3	389	0	0	302	26	0	328	1	2	1	0	0	3	2	39	1	30	1	71	0	791
5:45PM	19	362	4	1	386	0	1	276	30	0	307	0	2	0	0	0	2	0	30	0	14	0	44	0	739
<b>Total</b>	75	1457	7	7	1546	0	2	1163	97	3	1265	2	6	1	2	0	9	2	140	2	76	1	219	0	3039
<b>% Approach</b>	4.9%	94.2%	0.5%	0.5%	-	-	0.2%	91.9%	7.7%	0.2%	-	-	66.7%	11.1%	22.2%	0%	-	-	63.9%	0.9%	34.7%	0.5%	-	-	-
<b>% Total</b>	2.5%	47.9%	0.2%	0.2%	50.9%	-	0.1%	38.3%	3.2%	0.1%	41.6%	-	0.2%	0%	0.1%	0%	0.3%	-	4.6%	0.1%	2.5%	0%	7.2%	-	-
<b>PHF</b>	0.852	0.971	0.438	0.583	0.966	-	0.500	0.920	0.808	0.375	0.936	-	0.750	0.250	0.500	-	0.750	-	0.897	0.500	0.633	0.250	0.771	-	0.949
<b>Lights</b>	75	1451	7	7	1540	-	2	1155	97	3	1257	-	6	1	2	0	9	-	140	2	76	1	219	-	3025
<b>% Lights</b>	100%	99.6%	100%	100%	99.6%	-	100%	99.3%	100%	100%	99.4%	-	100%	100%	100%	0%	100%	-	100%	100%	100%	100%	100%	-	99.5%
<b>Articulated Trucks</b>	0	1	0	0	1	-	0	1	0	0	1	-	0	0	0	0	0	-	0	0	0	0	0	-	2
<b>% Articulated Trucks</b>	0%	0.1%	0%	0%	0.1%	-	0%	0.1%	0%	0%	0.1%	-	0%	0%	0%	0%	0%	-	0%	0%	0%	0%	0%	-	0.1%
<b>Buses and Single-Unit Trucks</b>	0	5	0	0	5	-	0	7	0	0	7	-	0	0	0	0	0	-	0	0	0	0	0	-	12
<b>% Buses and Single-Unit Trucks</b>	0%	0.3%	0%	0%	0.3%	-	0%	0.6%	0%	0%	0.6%	-	0%	0%	0%	0%	0%	-	0%	0%	0%	0%	0%	-	0.4%
<b>Pedestrians</b>	-	-	-	-	-	0	-	-	-	-	-	2	-	-	-	-	-	2	-	-	-	-	-	0	-
<b>% Pedestrians</b>	-	-	-	-	-	-	-	-	-	-	-	100%	-	-	-	-	-	100%	-	-	-	-	-	-	-
<b>Bicycles on Crosswalk</b>	-	-	-	-	-	0	-	-	-	-	-	0	-	-	-	-	-	0	-	-	-	-	-	0	-
<b>% Bicycles on Crosswalk</b>	-	-	-	-	-	-	-	-	-	-	-	0%	-	-	-	-	-	0%	-	-	-	-	-	-	-

\*Pedestrians and Bicycles on Crosswalk. L: Left, R: Right, T: Thru, U: U-Turn

2. Belt Line Road at Ladera Drive - TMC

Wed May 12, 2021

Full Length (7 AM-9 AM, 4:30 PM-6:30 PM)

All Classes (Lights, Articulated Trucks, Buses and Single-Unit Trucks, Pedestrians, Bicycles on Crosswalk)

All Movements

ID: 835141, Location: 32.954027, -96.806943



Provided by: C. J. Hensch & Associates Inc.  
5215 Sycamore Ave.,  
Pasadena, TX, 77503, US

Leg Direction	Belt Line Road Eastbound						Belt Line Road Westbound						Ladera Drive Northbound						Ladera Drive Southbound						Int
	L	T	R	U	App	Ped*	L	T	R	U	App	Ped*	L	T	R	U	App	Ped*	L	T	R	U	App	Ped*	
2021-05-12 7:00AM	1	114	4	0	119	2	4	172	2	0	178	0	3	1	14	0	18	0	7	0	11	0	18	0	333
7:15AM	3	182	4	1	190	0	6	225	3	0	234	0	7	0	11	0	18	0	9	0	23	0	32	0	474
7:30AM	7	179	2	1	189	0	3	297	1	0	301	0	8	0	20	0	28	2	5	0	31	0	36	0	554
7:45AM	12	175	5	0	192	0	6	331	7	0	344	0	13	0	15	0	28	0	4	0	21	0	25	0	589
Hourly Total	23	650	15	2	690	2	19	1025	13	0	1057	0	31	1	60	0	92	2	25	0	86	0	111	0	1950
8:00AM	8	175	4	0	187	0	7	257	0	0	264	0	9	0	8	0	17	0	3	0	12	0	15	0	483
8:15AM	8	161	4	0	173	1	5	298	1	0	304	0	8	0	20	0	28	4	3	0	12	0	15	0	520
8:30AM	9	181	3	1	194	0	4	266	5	0	275	0	4	0	14	0	18	1	3	0	12	0	15	0	502
8:45AM	13	162	3	1	179	1	5	277	2	0	284	0	6	0	10	0	16	2	3	0	15	0	18	0	497
Hourly Total	38	679	14	2	733	2	21	1098	8	0	1127	0	27	0	52	0	79	7	12	0	51	0	63	0	2002
4:30PM	19	330	3	1	353	0	13	303	7	0	323	0	3	1	13	0	17	1	2	0	13	0	15	0	708
4:45PM	23	357	16	0	396	0	7	281	12	2	302	0	4	0	7	0	11	0	4	0	12	0	16	0	725
Hourly Total	42	687	19	1	749	0	20	584	19	2	625	0	7	1	20	0	28	1	6	0	25	0	31	0	1433
5:00PM	17	412	9	1	439	0	17	306	10	0	333	0	1	1	10	0	12	0	2	0	17	0	19	1	803
5:15PM	18	378	14	1	411	0	17	307	9	1	334	0	6	0	13	0	19	2	5	0	14	0	19	1	783
5:30PM	34	358	14	0	406	0	25	272	13	1	311	0	4	0	16	0	20	1	4	1	13	0	18	0	755
5:45PM	20	331	15	0	366	1	14	272	10	0	296	0	3	0	13	0	16	2	4	0	21	0	25	2	703
Hourly Total	89	1479	52	2	1622	1	73	1157	42	2	1274	0	14	1	52	0	67	5	15	1	65	0	81	4	3044
6:00PM	18	302	11	2	333	0	15	291	10	0	316	0	4	0	17	0	21	3	1	0	20	0	21	1	691
6:15PM	13	334	10	0	357	0	9	271	13	3	296	0	4	0	12	0	16	0	5	0	15	0	20	0	689
Hourly Total	31	636	21	2	690	0	24	562	23	3	612	0	8	0	29	0	37	3	6	0	35	0	41	1	1380
<b>Total</b>	223	4131	121	9	4484	5	157	4426	105	7	4695	0	87	3	213	0	303	18	64	1	262	0	327	5	9809
<b>% Approach</b>	5.0%	92.1%	2.7%	0.2%	-	-	3.3%	94.3%	2.2%	0.1%	-	-	28.7%	1.0%	70.3%	0%	-	-	19.6%	0.3%	80.1%	0%	-	-	-
<b>% Total</b>	2.3%	42.1%	1.2%	0.1%	45.7%	-	1.6%	45.1%	1.1%	0.1%	47.9%	-	0.9%	0%	2.2%	0%	3.1%	-	0.7%	0%	2.7%	0%	3.3%	-	-
<b>Lights</b>	222	4079	120	9	4430	-	157	4369	105	7	4638	-	87	3	212	0	302	-	64	1	262	0	327	-	9697
<b>% Lights</b>	99.6%	98.7%	99.2%	100%	98.8%	-	100%	98.7%	100%	100%	98.8%	-	100%	100%	99.5%	0%	99.7%	-	100%	100%	100%	0%	100%	-	98.9%
<b>Articulated Trucks</b>	0	6	0	0	6	-	0	6	0	0	6	-	0	0	0	0	0	-	0	0	0	0	0	-	12
<b>% Articulated Trucks</b>	0%	0.1%	0%	0%	0.1%	-	0%	0.1%	0%	0%	0.1%	-	0%	0%	0%	0%	0%	-	0%	0%	0%	0%	0%	-	0.1%
<b>Buses and Single-Unit Trucks</b>	1	46	1	0	48	-	0	51	0	0	51	-	0	0	1	0	1	-	0	0	0	0	0	-	100
<b>% Buses and Single-Unit Trucks</b>	0.4%	1.1%	0.8%	0%	1.1%	-	0%	1.2%	0%	0%	1.1%	-	0%	0%	0.5%	0%	0.3%	-	0%	0%	0%	0%	0%	-	1.0%
<b>Pedestrians</b>	-	-	-	-	-	5	-	-	-	-	-	0	-	-	-	-	-	13	-	-	-	-	-	5	
<b>% Pedestrians</b>	-	-	-	-	-	100%	-	-	-	-	-	-	-	-	-	-	-	72.2%	-	-	-	-	-	100%	-
<b>Bicycles on Crosswalk</b>	-	-	-	-	-	0	-	-	-	-	-	0	-	-	-	-	-	5	-	-	-	-	-	0	
<b>% Bicycles on Crosswalk</b>	-	-	-	-	-	0%	-	-	-	-	-	-	-	-	-	-	-	27.8%	-	-	-	-	-	0%	-

\*Pedestrians and Bicycles on Crosswalk. L: Left, R: Right, T: Thru, U: U-Turn

## 2. Belt Line Road at Ladera Drive - TMC

Wed May 12, 2021

AM Peak (7:30 AM - 8:30 AM)

All Classes (Lights, Articulated Trucks, Buses and Single-Unit Trucks, Pedestrians, Bicycles on Crosswalk)

All Movements

ID: 835141, Location: 32.954027, -96.806943



Provided by: C. J. Hensch & Associates Inc.

5215 Sycamore Ave.,  
Pasadena, TX, 77503, US

Leg Direction	Belt Line Road Eastbound						Belt Line Road Westbound						Ladera Drive Northbound						Ladera Drive Southbound						Int
	L	T	R	U	App	Ped*	L	T	R	U	App	Ped*	L	T	R	U	App	Ped*	L	T	R	U	App	Ped*	
2021-05-12 7:30AM	7	179	2	1	189	0	3	297	1	0	301	0	8	0	20	0	28	2	5	0	31	0	36	0	554
7:45AM	12	175	5	0	192	0	6	331	7	0	344	0	13	0	15	0	28	0	4	0	21	0	25	0	589
8:00AM	8	175	4	0	187	0	7	257	0	0	264	0	9	0	8	0	17	0	3	0	12	0	15	0	483
8:15AM	8	161	4	0	173	1	5	298	1	0	304	0	8	0	20	0	28	4	3	0	12	0	15	0	520
<b>Total</b>	35	690	15	1	741	1	21	1183	9	0	1213	0	38	0	63	0	101	6	15	0	76	0	91	0	2146
<b>% Approach</b>	4.7%	93.1%	2.0%	0.1%	-	-	1.7%	97.5%	0.7%	0%	-	-	37.6%	0%	62.4%	0%	-	-	16.5%	0%	83.5%	0%	-	-	-
<b>% Total</b>	1.6%	32.2%	0.7%	0%	34.5%	-	1.0%	55.1%	0.4%	0%	56.5%	-	1.8%	0%	2.9%	0%	4.7%	-	0.7%	0%	3.5%	0%	4.2%	-	-
<b>PHF</b>	0.729	0.964	0.750	0.250	0.965	-	0.750	0.894	0.321	-	0.882	-	0.731	-	0.788	-	0.902	-	0.750	-	0.613	-	0.632	-	0.911
<b>Lights</b>	34	674	15	1	724	-	21	1167	9	0	1197	-	38	0	63	0	101	-	15	0	76	0	91	-	2113
<b>% Lights</b>	97.1%	97.7%	100%	100%	97.7%	-	100%	98.6%	100%	0%	98.7%	-	100%	0%	100%	0%	100%	-	100%	0%	100%	0%	100%	-	98.5%
<b>Articulated Trucks</b>	0	3	0	0	3	-	0	0	0	0	0	-	0	0	0	0	0	-	0	0	0	0	0	-	3
<b>% Articulated Trucks</b>	0%	0.4%	0%	0%	0.4%	-	0%	0%	0%	0%	0%	-	0%	0%	0%	0%	0%	-	0%	0%	0%	0%	0%	-	0.1%
<b>Buses and Single-Unit Trucks</b>	1	13	0	0	14	-	0	16	0	0	16	-	0	0	0	0	0	-	0	0	0	0	0	-	30
<b>% Buses and Single-Unit Trucks</b>	2.9%	1.9%	0%	0%	1.9%	-	0%	1.4%	0%	0%	1.3%	-	0%	0%	0%	0%	0%	-	0%	0%	0%	0%	0%	-	1.4%
<b>Pedestrians</b>	-	-	-	-	-	1	-	-	-	-	-	0	-	-	-	-	-	5	-	-	-	-	-	0	
<b>% Pedestrians</b>	-	-	-	-	-	100%	-	-	-	-	-	-	-	-	-	-	-	83.3%	-	-	-	-	-	-	
<b>Bicycles on Crosswalk</b>	-	-	-	-	-	0	-	-	-	-	-	0	-	-	-	-	-	1	-	-	-	-	-	0	
<b>% Bicycles on Crosswalk</b>	-	-	-	-	-	0%	-	-	-	-	-	-	-	-	-	-	-	16.7%	-	-	-	-	-	-	

\*Pedestrians and Bicycles on Crosswalk. L: Left, R: Right, T: Thru, U: U-Turn

2. Belt Line Road at Ladera Drive - TMC

Wed May 12, 2021

PM Peak (4:45 PM - 5:45 PM) - Overall Peak Hour

All Classes (Lights, Articulated Trucks, Buses and Single-Unit Trucks, Pedestrians, Bicycles on Crosswalk)

All Movements

ID: 835141, Location: 32.954027, -96.806943



Provided by: C. J. Hensch & Associates Inc.

5215 Sycamore Ave.,  
Pasadena, TX, 77503, US

Leg Direction	Belt Line Road Eastbound						Belt Line Road Westbound						Ladera Drive Northbound						Ladera Drive Southbound						Int	
	L	T	R	U	App	Ped*	L	T	R	U	App	Ped*	L	T	R	U	App	Ped*	L	T	R	U	App	Ped*		
2021-05-12 4:45PM	23	357	16	0	396	0	7	281	12	2	302	0	4	0	7	0	11	0	4	0	12	0	16	0	725	
5:00PM	17	412	9	1	439	0	17	306	10	0	333	0	1	1	10	0	12	0	2	0	17	0	19	1	803	
5:15PM	18	378	14	1	411	0	17	307	9	1	334	0	6	0	13	0	19	2	5	0	14	0	19	1	783	
5:30PM	34	358	14	0	406	0	25	272	13	1	311	0	4	0	16	0	20	1	4	1	13	0	18	0	755	
<b>Total</b>	92	1505	53	2	1652	0	66	1166	44	4	1280	0	15	1	46	0	62	3	15	1	56	0	72	2	3066	
<b>% Approach</b>	5.6%	91.1%	3.2%	0.1%	-	-	5.2%	91.1%	3.4%	0.3%	-	-	24.2%	1.6%	74.2%	0%	-	-	20.8%	1.4%	77.8%	0%	-	-	-	
<b>% Total</b>	3.0%	49.1%	1.7%	0.1%	53.9%	-	2.2%	38.0%	1.4%	0.1%	41.7%	-	0.5%	0%	1.5%	0%	2.0%	-	0.5%	0%	1.8%	0%	2.3%	-	-	
<b>PHF</b>	0.676	0.913	0.828	0.500	0.941	-	0.660	0.950	0.846	0.500	0.958	-	0.625	0.250	0.719	-	0.775	-	0.750	0.250	0.824	-	0.947	-	0.955	
<b>Lights</b>	92	1494	53	2	1641	-	66	1158	44	4	1272	-	15	1	46	0	62	-	15	1	56	0	72	-	3047	
<b>% Lights</b>	100%	99.3%	100%	100%	99.3%	-	100%	99.3%	100%	100%	99.4%	-	100%	100%	100%	0%	100%	-	100%	100%	100%	0%	100%	-	99.4%	
<b>Articulated Trucks</b>	0	0	0	0	0	-	0	1	0	0	1	-	0	0	0	0	0	-	0	0	0	0	0	0	-	1
<b>% Articulated Trucks</b>	0%	0%	0%	0%	0%	-	0%	0.1%	0%	0%	0.1%	-	0%	0%	0%	0%	0%	-	0%	0%	0%	0%	0%	0%	-	0%
<b>Buses and Single-Unit Trucks</b>	0	11	0	0	11	-	0	7	0	0	7	-	0	0	0	0	0	-	0	0	0	0	0	0	-	18
<b>% Buses and Single-Unit Trucks</b>	0%	0.7%	0%	0%	0.7%	-	0%	0.6%	0%	0%	0.5%	-	0%	0%	0%	0%	0%	-	0%	0%	0%	0%	0%	0%	-	0.6%
<b>Pedestrians</b>	-	-	-	-	-	0	-	-	-	-	-	0	-	-	-	-	-	2	-	-	-	-	-	-	2	
<b>% Pedestrians</b>	-	-	-	-	-	-	-	-	-	-	-	-	-	-	-	-	-	66.7%	-	-	-	-	-	-	100%	
<b>Bicycles on Crosswalk</b>	-	-	-	-	-	0	-	-	-	-	-	0	-	-	-	-	-	1	-	-	-	-	-	-	0	
<b>% Bicycles on Crosswalk</b>	-	-	-	-	-	-	-	-	-	-	-	-	-	-	-	-	-	33.3%	-	-	-	-	-	-	0%	

\*Pedestrians and Bicycles on Crosswalk. L: Left, R: Right, T: Thru, U: U-Turn

### 3. Belt Line Road at Median Opening - TMC

Wed May 12, 2021

Full Length (7 AM-9 AM, 4:30 PM-6:30 PM)

All Classes (Lights, Articulated Trucks, Buses and Single-Unit Trucks, Pedestrians, Bicycles on Crosswalk)

All Movements

ID: 835142, Location: 32.953598, -96.802344



Provided by: C. J. Hensch & Associates  
Inc.  
5215 Sycamore Ave.,  
Pasadena, TX, 77503, US

Leg Direction	Belt Line Road Eastbound						Belt Line Road Westbound						Driveway Northbound						Driveway Southbound						Int
	L	T	R	U	App	Ped*	L	T	R	U	App	Ped*	L	T	R	U	App	Ped*	L	T	R	U	App	Ped*	
2021-05-12 7:00AM	1	69	1	0	71	0	3	128	2	0	133	0	1	0	0	0	1	0	0	0	0	0	0	0	205
7:15AM	0	113	0	1	114	0	0	209	0	0	209	0	0	0	0	0	0	0	0	0	0	0	0	0	323
7:30AM	6	114	0	1	121	0	2	228	4	0	234	0	0	0	0	0	0	1	0	0	1	0	1	0	356
7:45AM	4	150	0	1	155	0	4	270	4	0	278	0	0	0	0	0	0	0	0	0	0	0	0	0	433
Hourly Total	11	446	1	3	461	0	9	835	10	0	854	0	1	0	0	0	1	1	0	0	1	0	1	0	1317
8:00AM	5	101	0	0	106	0	6	240	2	0	248	0	1	2	0	0	3	1	0	0	1	0	1	0	358
8:15AM	5	116	4	2	127	0	0	214	6	0	220	0	0	0	0	0	0	0	1	0	1	0	2	0	349
8:30AM	3	118	1	1	123	0	1	174	6	0	181	0	0	0	0	0	0	0	0	0	0	0	0	0	304
8:45AM	7	78	1	1	87	0	3	219	4	0	226	0	0	0	1	0	1	0	1	0	0	0	1	0	315
Hourly Total	20	413	6	4	443	0	10	847	18	0	875	0	1	2	1	0	4	1	2	0	2	0	4	0	1326
4:30PM	3	271	4	4	282	0	3	200	1	1	205	0	0	0	2	0	2	0	3	0	5	0	8	0	497
4:45PM	1	267	3	0	271	0	3	197	2	0	202	0	2	0	0	0	2	1	4	0	2	0	6	0	481
Hourly Total	4	538	7	4	553	0	6	397	3	1	407	0	2	0	2	0	4	1	7	0	7	0	14	0	978
5:00PM	0	251	3	2	256	0	3	190	1	0	194	0	0	0	0	0	0	0	10	1	8	0	19	0	469
5:15PM	2	310	2	0	314	0	3	202	1	0	206	0	0	0	0	0	0	0	2	0	5	0	7	0	527
5:30PM	1	270	7	1	279	0	4	186	0	0	190	0	1	0	0	0	1	0	1	0	0	0	1	0	471
5:45PM	1	262	1	2	266	0	7	194	1	0	202	0	2	0	0	0	2	0	1	1	3	0	5	0	475
Hourly Total	4	1093	13	5	1115	0	17	772	3	0	792	0	3	0	0	0	3	0	14	2	16	0	32	0	1942
6:00PM	1	226	0	2	229	0	6	193	0	1	200	0	0	0	1	0	1	0	2	0	1	0	3	0	433
6:15PM	1	183	2	1	187	0	9	189	7	0	205	0	2	0	0	0	2	0	1	0	1	0	2	0	396
Hourly Total	2	409	2	3	416	0	15	382	7	1	405	0	2	0	1	0	3	0	3	0	2	0	5	0	829
<b>Total</b>	41	2899	29	19	2988	0	57	3233	41	2	3333	0	9	2	4	0	15	3	26	2	28	0	56	0	6392
<b>% Approach</b>	1.4%	97.0%	1.0%	0.6%	-	-	1.7%	97.0%	1.2%	0.1%	-	-	60.0%	13.3%	26.7%	0%	-	-	46.4%	3.6%	50.0%	0%	-	-	-
<b>% Total</b>	0.6%	45.4%	0.5%	0.3%	46.7%	-	0.9%	50.6%	0.6%	0%	52.1%	-	0.1%	0%	0.1%	0%	0.2%	-	0.4%	0%	0.4%	0%	0.9%	-	-
<b>Lights</b>	41	2863	29	19	2952	-	57	3190	41	2	3290	-	9	2	4	0	15	-	26	2	28	0	56	-	6313
<b>% Lights</b>	100%	98.8%	100%	100%	98.8%	-	100%	98.7%	100%	100%	98.7%	-	100%	100%	100%	0%	100%	-	100%	100%	100%	0%	100%	-	98.8%
<b>Articulated Trucks</b>	0	6	0	0	6	-	0	4	0	0	4	-	0	0	0	0	0	-	0	0	0	0	0	-	10
<b>% Articulated Trucks</b>	0%	0.2%	0%	0%	0.2%	-	0%	0.1%	0%	0%	0.1%	-	0%	0%	0%	0%	0%	-	0%	0%	0%	0%	0%	-	0.2%
<b>Buses and Single-Unit Trucks</b>	0	30	0	0	30	-	0	39	0	0	39	-	0	0	0	0	0	-	0	0	0	0	0	-	69
<b>% Buses and Single-Unit Trucks</b>	0%	1.0%	0%	0%	1.0%	-	0%	1.2%	0%	0%	1.2%	-	0%	0%	0%	0%	0%	-	0%	0%	0%	0%	0%	-	1.1%
<b>Pedestrians</b>	-	-	-	-	-	0	-	-	-	-	-	0	-	-	-	-	-	3	-	-	-	-	-	0	-
<b>% Pedestrians</b>	-	-	-	-	-	-	-	-	-	-	-	-	-	-	-	-	-	100%	-	-	-	-	-	-	-
<b>Bicycles on Crosswalk</b>	-	-	-	-	-	0	-	-	-	-	-	0	-	-	-	-	-	0	-	-	-	-	-	0	-
<b>% Bicycles on Crosswalk</b>	-	-	-	-	-	-	-	-	-	-	-	-	-	-	-	-	-	0%	-	-	-	-	-	-	-

\*Pedestrians and Bicycles on Crosswalk. L: Left, R: Right, T: Thru, U: U-Turn

### 3. Belt Line Road at Median Opening - TMC

Wed May 12, 2021

AM Peak (7:30 AM - 8:30 AM)

All Classes (Lights, Articulated Trucks, Buses and Single-Unit Trucks, Pedestrians, Bicycles on Crosswalk)

All Movements

ID: 835142, Location: 32.953598, -96.802344



Provided by: C. J. Hensch & Associates Inc.

5215 Sycamore Ave.,  
Pasadena, TX, 77503, US

Leg Direction	Belt Line Road Eastbound						Belt Line Road Westbound						Driveway Northbound						Driveway Southbound						Int
	L	T	R	U	App	Ped*	L	T	R	U	App	Ped*	L	T	R	U	App	Ped*	L	T	R	U	App	Ped*	
2021-05-12 7:30AM	6	114	0	1	121	0	2	228	4	0	234	0	0	0	0	0	0	1	0	0	1	0	1	0	356
7:45AM	4	150	0	1	155	0	4	270	4	0	278	0	0	0	0	0	0	0	0	0	0	0	0	0	433
8:00AM	5	101	0	0	106	0	6	240	2	0	248	0	1	2	0	0	3	1	0	0	1	0	1	0	358
8:15AM	5	116	4	2	127	0	0	214	6	0	220	0	0	0	0	0	0	0	1	0	1	0	2	0	349
<b>Total</b>	20	481	4	4	509	0	12	952	16	0	980	0	1	2	0	0	3	2	1	0	3	0	4	0	1496
<b>% Approach</b>	3.9%	94.5%	0.8%	0.8%	-	-	1.2%	97.1%	1.6%	0%	-	-	33.3%	66.7%	0%	0%	-	-	25.0%	0%	75.0%	0%	-	-	-
<b>% Total</b>	1.3%	32.2%	0.3%	0.3%	34.0%	-	0.8%	63.6%	1.1%	0%	65.5%	-	0.1%	0.1%	0%	0%	0.2%	-	0.1%	0%	0.2%	0%	0.3%	-	-
<b>PHF</b>	0.833	0.802	0.250	0.500	0.821	-	0.500	0.881	0.667	-	0.881	-	0.250	0.250	-	-	0.250	-	0.250	-	0.750	-	0.500	-	0.864
<b>Lights</b>	20	473	4	4	501	-	12	939	16	0	967	-	1	2	0	0	3	-	1	0	3	0	4	-	1475
<b>% Lights</b>	100%	98.3%	100%	100%	98.4%	-	100%	98.6%	100%	0%	98.7%	-	100%	100%	0%	0%	100%	-	100%	0%	100%	0%	100%	-	98.6%
<b>Articulated Trucks</b>	0	1	0	0	1	-	0	0	0	0	0	-	0	0	0	0	0	-	0	0	0	0	0	-	1
<b>% Articulated Trucks</b>	0%	0.2%	0%	0%	0.2%	-	0%	0%	0%	0%	0%	-	0%	0%	0%	0%	0%	-	0%	0%	0%	0%	0%	-	0.1%
<b>Buses and Single-Unit Trucks</b>	0	7	0	0	7	-	0	13	0	0	13	-	0	0	0	0	0	-	0	0	0	0	0	-	20
<b>% Buses and Single-Unit Trucks</b>	0%	1.5%	0%	0%	1.4%	-	0%	1.4%	0%	0%	1.3%	-	0%	0%	0%	0%	0%	-	0%	0%	0%	0%	0%	-	1.3%
Pedestrians	-	-	-	-	-	0	-	-	-	-	-	0	-	-	-	-	-	2	-	-	-	-	-	0	
<b>% Pedestrians</b>	-	-	-	-	-	-	-	-	-	-	-	-	-	-	-	-	-	100%	-	-	-	-	-	-	-
Bicycles on Crosswalk	-	-	-	-	-	0	-	-	-	-	-	0	-	-	-	-	-	0	-	-	-	-	-	0	
<b>% Bicycles on Crosswalk</b>	-	-	-	-	-	-	-	-	-	-	-	-	-	-	-	-	-	0%	-	-	-	-	-	-	-

\*Pedestrians and Bicycles on Crosswalk. L: Left, R: Right, T: Thru, U: U-Turn



### 3. Belt Line Road at Median Opening - TMC

Wed May 12, 2021

PM Peak (4:30 PM - 5:30 PM) - Overall Peak Hour

All Classes (Lights, Articulated Trucks, Buses and Single-Unit Trucks, Pedestrians, Bicycles on Crosswalk)

All Movements

ID: 835142, Location: 32.953598, -96.802344



Provided by: C. J. Hensch & Associates Inc.

5215 Sycamore Ave.,  
Pasadena, TX, 77503, US

Leg Direction	Belt Line Road Eastbound						Belt Line Road Westbound						Driveway Northbound						Driveway Southbound						Int
	L	T	R	U	App	Ped*	L	T	R	U	App	Ped*	L	T	R	U	App	Ped*	L	T	R	U	App	Ped*	
2021-05-12 4:30PM	3	271	4	4	<b>282</b>	0	3	200	1	1	<b>205</b>	0	0	0	2	0	<b>2</b>	0	3	0	5	0	<b>8</b>	0	<b>497</b>
4:45PM	1	267	3	0	<b>271</b>	0	3	197	2	0	<b>202</b>	0	2	0	0	0	<b>2</b>	1	4	0	2	0	<b>6</b>	0	<b>481</b>
5:00PM	0	251	3	2	<b>256</b>	0	3	190	1	0	<b>194</b>	0	0	0	0	0	<b>0</b>	0	10	1	8	0	<b>19</b>	0	<b>469</b>
5:15PM	2	310	2	0	<b>314</b>	0	3	202	1	0	<b>206</b>	0	0	0	0	0	<b>0</b>	0	2	0	5	0	<b>7</b>	0	<b>527</b>
<b>Total</b>	<b>6</b>	<b>1099</b>	<b>12</b>	<b>6</b>	<b>1123</b>	<b>0</b>	<b>12</b>	<b>789</b>	<b>5</b>	<b>1</b>	<b>807</b>	<b>0</b>	<b>2</b>	<b>0</b>	<b>2</b>	<b>0</b>	<b>4</b>	<b>1</b>	<b>19</b>	<b>1</b>	<b>20</b>	<b>0</b>	<b>40</b>	<b>0</b>	<b>1974</b>
<b>% Approach</b>	0.5%	97.9%	1.1%	0.5%	-	-	1.5%	97.8%	0.6%	0.1%	-	-	50.0%	0%	50.0%	0%	-	-	47.5%	2.5%	50.0%	0%	-	-	-
<b>% Total</b>	0.3%	55.7%	0.6%	0.3%	<b>56.9%</b>	-	0.6%	40.0%	0.3%	0.1%	<b>40.9%</b>	-	0.1%	0%	0.1%	0%	<b>0.2%</b>	-	1.0%	0.1%	1.0%	0%	<b>2.0%</b>	-	-
<b>PHF</b>	0.500	0.886	0.750	0.375	<b>0.894</b>	-	1.000	0.976	0.625	0.250	<b>0.979</b>	-	0.250	-	0.250	-	<b>-0.500</b>	-	0.475	0.250	0.625	-	<b>-0.526</b>	-	0.936
<b>Lights</b>	6	1089	12	6	<b>1113</b>	-	12	780	5	1	<b>798</b>	-	2	0	2	0	<b>4</b>	-	19	1	20	0	<b>40</b>	-	1955
<b>% Lights</b>	100%	99.1%	100%	100%	<b>99.1%</b>	-	100%	98.9%	100%	100%	<b>98.9%</b>	-	100%	0%	100%	0%	<b>100%</b>	-	100%	100%	100%	0%	<b>100%</b>	-	99.0%
<b>Articulated Trucks</b>	0	0	0	0	<b>0</b>	-	0	2	0	0	<b>2</b>	-	0	0	0	0	<b>0</b>	-	0	0	0	0	<b>0</b>	-	2
<b>% Articulated Trucks</b>	0%	0%	0%	0%	<b>0%</b>	-	0%	0.3%	0%	0%	<b>0.2%</b>	-	0%	0%	0%	0%	<b>0%</b>	-	0%	0%	0%	0%	<b>0%</b>	-	0.1%
<b>Buses and Single-Unit Trucks</b>	0	10	0	0	<b>10</b>	-	0	7	0	0	<b>7</b>	-	0	0	0	0	<b>0</b>	-	0	0	0	0	<b>0</b>	-	17
<b>% Buses and Single-Unit Trucks</b>	0%	0.9%	0%	0%	<b>0.9%</b>	-	0%	0.9%	0%	0%	<b>0.9%</b>	-	0%	0%	0%	0%	<b>0%</b>	-	0%	0%	0%	0%	<b>0%</b>	-	0.9%
Pedestrians	-	-	-	-	-	0	-	-	-	-	-	0	-	-	-	-	-	1	-	-	-	-	-	0	-
% Pedestrians	-	-	-	-	-	-	-	-	-	-	-	-	-	-	-	-	-	100%	-	-	-	-	-	-	-
Bicycles on Crosswalk	-	-	-	-	-	0	-	-	-	-	-	0	-	-	-	-	-	0	-	-	-	-	-	0	-
% Bicycles on Crosswalk	-	-	-	-	-	-	-	-	-	-	-	-	-	-	-	-	-	0%	-	-	-	-	-	-	-

\*Pedestrians and Bicycles on Crosswalk. L: Left, R: Right, T: Thru, U: U-Turn

4. Belt Line Road at Berry Trail - TMC

Wed May 12, 2021

Full Length (7 AM-9 AM, 4:30 PM-6:30 PM)

All Classes (Lights, Articulated Trucks, Buses and Single-Unit Trucks, Pedestrians, Bicycles on Crosswalk)

All Movements

ID: 835143, Location: 32.952679, -96.800648



Provided by: C. J. Hensch & Associates Inc.  
5215 Sycamore Ave.,  
Pasadena, TX, 77503, US

Leg Direction	Belt Line Road Eastbound						Belt Line Road Westbound						Driveway Northbound						Berry Trail Southbound						Int
	L	T	R	U	App	Ped*	L	T	R	U	App	Ped*	L	T	R	U	App	Ped*	L	T	R	U	App	Ped*	
2021-05-12 7:00AM	2	67	0	0	69	0	1	125	2	0	128	0	1	0	1	0	2	0	5	1	6	0	12	0	211
7:15AM	2	105	0	0	107	0	1	192	2	0	195	0	1	0	0	0	1	0	7	2	14	0	23	0	326
7:30AM	4	111	0	0	115	0	1	220	6	0	227	1	0	0	0	0	0	1	5	2	12	0	19	0	361
7:45AM	4	138	4	0	146	0	0	266	5	0	271	0	0	0	0	0	0	0	14	3	17	0	34	0	451
Hourly Total	12	421	4	0	437	0	3	803	15	0	821	1	2	0	1	0	3	1	31	8	49	0	88	0	1349
8:00AM	2	95	0	0	97	0	0	237	6	0	243	0	0	1	0	0	1	1	5	0	14	0	19	0	360
8:15AM	3	120	0	0	123	0	2	205	3	0	210	1	1	0	0	0	1	1	10	2	15	0	27	0	361
8:30AM	1	112	1	0	114	0	3	167	4	0	174	0	2	0	1	0	3	0	6	0	9	0	15	0	306
8:45AM	6	73	3	0	82	0	3	218	2	0	223	0	1	0	0	0	1	1	12	1	13	0	26	0	332
Hourly Total	12	400	4	0	416	0	8	827	15	0	850	1	4	1	1	0	6	3	33	3	51	0	87	0	1359
4:30PM	14	268	1	2	285	0	0	195	3	0	198	0	2	1	0	0	3	0	6	0	9	0	15	0	501
4:45PM	11	243	1	0	255	0	6	192	6	0	204	0	2	5	1	0	8	1	2	2	10	0	14	0	481
Hourly Total	25	511	2	2	540	0	6	387	9	0	402	0	4	6	1	0	11	1	8	2	19	0	29	0	982
5:00PM	14	274	4	0	292	0	3	183	6	0	192	0	1	0	1	0	2	0	7	1	10	0	18	0	504
5:15PM	5	303	3	0	311	0	3	198	11	0	212	1	1	3	2	0	6	1	5	2	7	0	14	0	543
5:30PM	10	256	4	0	270	0	3	191	5	0	199	0	0	2	0	0	2	0	7	2	4	0	13	0	484
5:45PM	9	257	3	0	269	0	8	196	7	0	211	1	1	4	1	0	6	1	6	1	10	0	17	0	503
Hourly Total	38	1090	14	0	1142	0	17	768	29	0	814	2	3	9	4	0	16	2	25	6	31	0	62	0	2034
6:00PM	10	211	0	0	221	0	4	194	4	0	202	0	2	2	4	0	8	1	2	1	12	0	15	0	446
6:15PM	8	188	3	1	200	0	4	201	4	1	210	1	2	1	0	0	3	2	8	1	10	0	19	0	432
Hourly Total	18	399	3	1	421	0	8	395	8	1	412	1	4	3	4	0	11	3	10	2	22	0	34	0	878
<b>Total</b>	105	2821	27	3	2956	0	42	3180	76	1	3299	5	17	19	11	0	47	10	107	21	172	0	300	0	6602
<b>% Approach</b>	3.6%	95.4%	0.9%	0.1%	-	-	1.3%	96.4%	2.3%	0%	-	-	36.2%	40.4%	23.4%	0%	-	-	35.7%	7.0%	57.3%	0%	-	-	-
<b>% Total</b>	1.6%	42.7%	0.4%	0%	44.8%	-	0.6%	48.2%	1.2%	0%	50.0%	-	0.3%	0.3%	0.2%	0%	0.7%	-	1.6%	0.3%	2.6%	0%	4.5%	-	-
<b>Lights</b>	105	2785	26	3	2919	-	42	3140	75	1	3258	-	16	19	11	0	46	-	105	21	171	0	297	-	6520
<b>% Lights</b>	100%	98.7%	96.3%	100%	98.7%	-	100%	98.7%	98.7%	100%	98.8%	-	94.1%	100%	100%	0%	97.9%	-	98.1%	100%	99.4%	0%	99.0%	-	98.8%
<b>Articulated Trucks</b>	0	4	0	0	4	-	0	5	0	0	5	-	1	0	0	0	1	-	0	0	0	0	0	-	10
<b>% Articulated Trucks</b>	0%	0.1%	0%	0%	0.1%	-	0%	0.2%	0%	0%	0.2%	-	5.9%	0%	0%	0%	2.1%	-	0%	0%	0%	0%	0%	-	0.2%
<b>Buses and Single-Unit Trucks</b>	0	32	1	0	33	-	0	35	1	0	36	-	0	0	0	0	0	-	2	0	1	0	3	-	72
<b>% Buses and Single-Unit Trucks</b>	0%	1.1%	3.7%	0%	1.1%	-	0%	1.1%	1.3%	0%	1.1%	-	0%	0%	0%	0%	0%	-	1.9%	0%	0.6%	0%	1.0%	-	1.1%
<b>Pedestrians</b>	-	-	-	-	-	0	-	-	-	-	-	5	-	-	-	-	-	10	-	-	-	-	-	0	-
<b>% Pedestrians</b>	-	-	-	-	-	-	-	-	-	-	-	-100%	-	-	-	-	-	-100%	-	-	-	-	-	-	-
<b>Bicycles on Crosswalk</b>	-	-	-	-	-	0	-	-	-	-	-	0	-	-	-	-	-	0	-	-	-	-	-	0	-
<b>% Bicycles on Crosswalk</b>	-	-	-	-	-	-	-	-	-	-	-	0%	-	-	-	-	-	0%	-	-	-	-	-	-	-

\*Pedestrians and Bicycles on Crosswalk. L: Left, R: Right, T: Thru, U: U-Turn

#### 4. Belt Line Road at Berry Trail - TMC

Wed May 12, 2021

AM Peak (7:30 AM - 8:30 AM)

All Classes (Lights, Articulated Trucks, Buses and Single-Unit Trucks, Pedestrians, Bicycles on Crosswalk)

All Movements

ID: 835143, Location: 32.952679, -96.800648



Provided by: C. J. Hensch & Associates Inc.

5215 Sycamore Ave.,  
Pasadena, TX, 77503, US

Leg Direction	Belt Line Road Eastbound						Belt Line Road Westbound						Driveway Northbound						Berry Trail Southbound						Int	
Time	L	T	R	U	App	Ped*	L	T	R	U	App	Ped*	L	T	R	U	App	Ped*	L	T	R	U	App	Ped*	Int	
2021-05-12 7:30AM	4	111	0	0	115	0	1	220	6	0	227	1	0	0	0	0	0	0	1	5	2	12	0	19	0	361
7:45AM	4	138	4	0	146	0	0	266	5	0	271	0	0	0	0	0	0	0	0	14	3	17	0	34	0	451
8:00AM	2	95	0	0	97	0	0	237	6	0	243	0	0	1	0	0	1	1	5	0	14	0	19	0	360	
8:15AM	3	120	0	0	123	0	2	205	3	0	210	1	1	0	0	0	1	1	10	2	15	0	27	0	361	
<b>Total</b>	13	464	4	0	481	0	3	928	20	0	951	2	1	1	0	0	2	3	34	7	58	0	99	0	1533	
<b>% Approach</b>	2.7%	96.5%	0.8%	0%	-	-	0.3%	97.6%	2.1%	0%	-	-	50.0%	50.0%	0%	0%	-	-	34.3%	7.1%	58.6%	0%	-	-	-	
<b>% Total</b>	0.8%	30.3%	0.3%	0%	31.4%	-	0.2%	60.5%	1.3%	0%	62.0%	-	0.1%	0.1%	0%	0%	0.1%	-	2.2%	0.5%	3.8%	0%	6.5%	-	-	
<b>PHF</b>	0.813	0.841	0.250	-	0.824	-	0.375	0.872	0.833	-	0.877	-	0.250	0.250	-	-	0.500	-	0.607	0.583	0.853	-	0.728	-	0.850	
<b>Lights</b>	13	456	3	0	472	-	3	916	20	0	939	-	1	1	0	0	2	-	32	7	58	0	97	-	1510	
<b>% Lights</b>	100%	98.3%	75.0%	0%	98.1%	-	100%	98.7%	100%	0%	98.7%	-	100%	100%	0%	0%	100%	-	94.1%	100%	100%	0%	98.0%	-	98.5%	
<b>Articulated Trucks</b>	0	1	0	0	1	-	0	0	0	0	0	-	0	0	0	0	0	-	0	0	0	0	0	0	-	1
<b>% Articulated Trucks</b>	0%	0.2%	0%	0%	0.2%	-	0%	0%	0%	0%	0%	-	0%	0%	0%	0%	0%	-	0%	0%	0%	0%	0%	0%	-	0.1%
<b>Buses and Single-Unit Trucks</b>	0	7	1	0	8	-	0	12	0	0	12	-	0	0	0	0	0	-	2	0	0	0	2	-	22	
<b>% Buses and Single-Unit Trucks</b>	0%	1.5%	25.0%	0%	1.7%	-	0%	1.3%	0%	0%	1.3%	-	0%	0%	0%	0%	0%	-	5.9%	0%	0%	0%	2.0%	-	1.4%	
<b>Pedestrians</b>	-	-	-	-	-	0	-	-	-	-	-	2	-	-	-	-	-	3	-	-	-	-	-	-	0	
<b>% Pedestrians</b>	-	-	-	-	-	-	-	-	-	-	-	100%	-	-	-	-	-	100%	-	-	-	-	-	-	-	
<b>Bicycles on Crosswalk</b>	-	-	-	-	-	0	-	-	-	-	-	0	-	-	-	-	-	0	-	-	-	-	-	-	0	
<b>% Bicycles on Crosswalk</b>	-	-	-	-	-	-	-	-	-	-	-	0%	-	-	-	-	-	0%	-	-	-	-	-	-	-	

\*Pedestrians and Bicycles on Crosswalk. L: Left, R: Right, T: Thru, U: U-Turn

#### 4. Belt Line Road at Berry Trail - TMC

Wed May 12, 2021

PM Peak (5 PM - 6 PM) - Overall Peak Hour

All Classes (Lights, Articulated Trucks, Buses and Single-Unit Trucks, Pedestrians, Bicycles on Crosswalk)

All Movements

ID: 835143, Location: 32.952679, -96.800648



Provided by: C. J. Hensch & Associates Inc.

5215 Sycamore Ave.,  
Pasadena, TX, 77503, US

Leg Direction	Belt Line Road Eastbound					Belt Line Road Westbound					Driveway Northbound					Berry Trail Southbound					Int					
	L	T	R	U	App Ped*	L	T	R	U	App Ped*	L	T	R	U	App Ped*	L	T	R	U	App Ped*						
2021-05-12 5:00PM	14	274	4	0	292	0	3	183	6	0	192	0	1	0	1	0	2	0	7	1	10	0	18	0	504	
5:15PM	5	303	3	0	311	0	3	198	11	0	212	1	1	3	2	0	6	1	5	2	7	0	14	0	543	
5:30PM	10	256	4	0	270	0	3	191	5	0	199	0	0	2	0	0	2	0	7	2	4	0	13	0	484	
5:45PM	9	257	3	0	269	0	8	196	7	0	211	1	1	4	1	0	6	1	6	1	10	0	17	0	503	
<b>Total</b>	38	1090	14	0	1142	0	17	768	29	0	814	2	3	9	4	0	16	2	25	6	31	0	62	0	2034	
<b>% Approach</b>	3.3%	95.4%	1.2%	0%	-	-	2.1%	94.3%	3.6%	0%	-	-	18.8%	56.3%	25.0%	0%	-	-	40.3%	9.7%	50.0%	0%	-	-	-	
<b>% Total</b>	1.9%	53.6%	0.7%	0%	56.1%	-	0.8%	37.8%	1.4%	0%	40.0%	-	0.1%	0.4%	0.2%	0%	0.8%	-	1.2%	0.3%	1.5%	0%	3.0%	-	-	
<b>PHF</b>	0.679	0.899	0.875	-	0.918	-	0.531	0.970	0.659	-	0.960	-	0.750	0.563	0.500	-	0.667	-	0.893	0.750	0.775	-	0.861	-	0.936	
<b>Lights</b>	38	1082	14	0	1134	-	17	763	28	0	808	-	3	9	4	0	16	-	25	6	31	0	62	-	2020	
<b>% Lights</b>	100%	99.3%	100%	0%	99.3%	-	100%	99.3%	96.6%	0%	99.3%	-	100%	100%	100%	0%	100%	-	100%	100%	100%	0%	100%	-	99.3%	
<b>Articulated Trucks</b>	0	1	0	0	1	-	0	1	0	0	1	-	0	0	0	0	0	-	0	0	0	0	0	0	-	2
<b>% Articulated Trucks</b>	0%	0.1%	0%	0%	0.1%	-	0%	0.1%	0%	0%	0.1%	-	0%	0%	0%	0%	0%	-	0%	0%	0%	0%	0%	0%	-	0.1%
<b>Buses and Single-Unit Trucks</b>	0	7	0	0	7	-	0	4	1	0	5	-	0	0	0	0	0	-	0	0	0	0	0	0	-	12
<b>% Buses and Single-Unit Trucks</b>	0%	0.6%	0%	0%	0.6%	-	0%	0.5%	3.4%	0%	0.6%	-	0%	0%	0%	0%	0%	-	0%	0%	0%	0%	0%	0%	-	0.6%
Pedestrians	-	-	-	-	-	0	-	-	-	-	-	2	-	-	-	-	-	2	-	-	-	-	-	-	0	
% Pedestrians	-	-	-	-	-	-	-	-	-	-	-	100%	-	-	-	-	-	100%	-	-	-	-	-	-	-	
Bicycles on Crosswalk	-	-	-	-	-	0	-	-	-	-	-	0	-	-	-	-	-	0	-	-	-	-	-	-	0	
% Bicycles on Crosswalk	-	-	-	-	-	-	-	-	-	-	-	0%	-	-	-	-	-	0%	-	-	-	-	-	-	-	

\*Pedestrians and Bicycles on Crosswalk. L: Left, R: Right, T: Thru, U: U-Turn

5. Belt Line Road at Median Opening - TMC

Wed May 12, 2021

Full Length (7 AM-9 AM, 4:30 PM-6:30 PM)

All Classes (Lights, Articulated Trucks, Buses and Single-Unit Trucks, Pedestrians, Bicycles on Crosswalk)

All Movements

ID: 835144, Location: 32.951091, -96.799995



Provided by: C. J. Hensch & Associates Inc.  
5215 Sycamore Ave.,  
Pasadena, TX, 77503, US

Leg Direction	Belt Line Road Eastbound						Belt Line Road Westbound						Driveway Northbound						Driveway Southbound						Int
	L	T	R	U	App	Ped*	L	T	R	U	App	Ped*	L	T	R	U	App	Ped*	L	T	R	U	App	Ped*	
2021-05-12 7:00AM	1	70	0	0	71	0	2	124	0	0	126	0	0	1	0	0	1	0	1	1	0	0	2	0	200
7:15AM	1	106	0	0	107	0	1	192	1	0	194	0	0	0	0	0	0	0	1	0	5	0	6	1	307
7:30AM	0	129	0	0	129	0	2	226	0	0	228	0	1	0	0	0	1	0	3	1	3	0	7	1	365
7:45AM	0	154	0	1	155	0	1	266	3	0	270	0	0	0	0	0	0	1	1	0	2	0	3	0	428
Hourly Total	2	459	0	1	462	0	6	808	4	0	818	0	1	1	0	0	2	1	6	2	10	0	18	2	1300
8:00AM	1	98	0	0	99	0	5	251	5	0	261	0	0	0	0	0	0	1	1	0	0	0	1	1	361
8:15AM	2	134	0	1	137	0	3	205	3	0	211	0	0	0	0	0	0	0	1	0	2	0	3	0	351
8:30AM	0	119	0	0	119	0	3	175	4	0	182	0	0	0	1	0	1	1	1	1	2	0	4	1	306
8:45AM	1	81	1	0	83	0	4	234	3	0	241	0	0	0	2	0	2	0	3	0	2	0	5	0	331
Hourly Total	4	432	1	1	438	0	15	865	15	0	895	0	0	0	3	0	3	2	6	1	6	0	13	2	1349
4:30PM	2	265	0	2	269	0	8	194	2	1	205	0	0	1	4	0	5	0	0	1	1	0	2	1	481
4:45PM	2	235	0	2	239	0	7	205	3	1	216	0	0	1	6	0	7	1	0	0	3	0	3	1	465
Hourly Total	4	500	0	4	508	0	15	399	5	2	421	0	0	2	10	0	12	1	0	1	4	0	5	2	946
5:00PM	1	295	2	1	299	0	4	188	2	1	195	0	1	1	4	0	6	0	1	0	1	0	2	1	502
5:15PM	1	309	0	0	310	0	8	213	2	0	223	0	0	0	3	0	3	0	0	0	3	0	3	0	539
5:30PM	2	277	0	1	280	0	3	194	0	0	197	0	2	1	1	0	4	0	1	1	3	0	5	0	486
5:45PM	0	270	0	2	272	0	8	201	7	1	217	0	0	2	3	0	5	0	2	0	0	0	2	0	496
Hourly Total	4	1151	2	4	1161	0	23	796	11	2	832	0	3	4	11	0	18	0	4	1	7	0	12	1	2023
6:00PM	1	217	1	0	219	0	4	209	3	1	217	0	0	0	3	0	3	0	0	0	1	0	1	0	440
6:15PM	2	214	1	2	219	0	4	194	1	1	200	0	1	0	4	0	5	0	1	0	1	0	2	1	426
Hourly Total	3	431	2	2	438	0	8	403	4	2	417	0	1	0	7	0	8	0	1	0	2	0	3	1	866
<b>Total</b>	17	2973	5	12	3007	0	67	3271	39	6	3383	0	5	7	31	0	43	4	17	5	29	0	51	8	6484
<b>% Approach</b>	0.6%	98.9%	0.2%	0.4%	-	-	2.0%	96.7%	1.2%	0.2%	-	-	11.6%	16.3%	72.1%	0%	-	-	33.3%	9.8%	56.9%	0%	-	-	-
<b>% Total</b>	0.3%	45.9%	0.1%	0.2%	46.4%	-	1.0%	50.4%	0.6%	0.1%	52.2%	-	0.1%	0.1%	0.5%	0%	0.7%	-	0.3%	0.1%	0.4%	0%	0.8%	-	-
<b>Lights</b>	17	2931	5	12	2965	-	66	3231	38	6	3341	-	5	7	30	0	42	-	17	5	28	0	50	-	6398
<b>% Lights</b>	100%	98.6%	100%	100%	98.6%	-	98.5%	98.8%	97.4%	100%	98.8%	-	100%	100%	96.8%	0%	97.7%	-	100%	100%	96.6%	0%	98.0%	-	98.7%
<b>Articulated Trucks</b>	0	4	0	0	4	-	0	5	0	0	5	-	0	0	0	0	0	-	0	0	0	0	0	-	9
<b>% Articulated Trucks</b>	0%	0.1%	0%	0%	0.1%	-	0%	0.2%	0%	0%	0.1%	-	0%	0%	0%	0%	0%	-	0%	0%	0%	0%	0%	-	0.1%
<b>Buses and Single-Unit Trucks</b>	0	38	0	0	38	-	1	35	1	0	37	-	0	0	1	0	1	-	0	0	1	0	1	-	77
<b>% Buses and Single-Unit Trucks</b>	0%	1.3%	0%	0%	1.3%	-	1.5%	1.1%	2.6%	0%	1.1%	-	0%	0%	3.2%	0%	2.3%	-	0%	0%	3.4%	0%	2.0%	-	1.2%
<b>Pedestrians</b>	-	-	-	-	-	0	-	-	-	-	-	0	-	-	-	-	-	4	-	-	-	-	-	8	
<b>% Pedestrians</b>	-	-	-	-	-	-	-	-	-	-	-	-	-	-	-	-	-	100%	-	-	-	-	-	100%	-
<b>Bicycles on Crosswalk</b>	-	-	-	-	-	0	-	-	-	-	-	0	-	-	-	-	-	0	-	-	-	-	-	0	
<b>% Bicycles on Crosswalk</b>	-	-	-	-	-	-	-	-	-	-	-	-	-	-	-	-	-	0%	-	-	-	-	-	0%	

\*Pedestrians and Bicycles on Crosswalk. L: Left, R: Right, T: Thru, U: U-Turn

5. Belt Line Road at Median Opening - TMC

Wed May 12, 2021

AM Peak (7:30 AM - 8:30 AM)

All Classes (Lights, Articulated Trucks, Buses and Single-Unit Trucks, Pedestrians, Bicycles on Crosswalk)

All Movements

ID: 835144, Location: 32.951091, -96.799995



Provided by: C. J. Hensch & Associates Inc.

5215 Sycamore Ave., Pasadena, TX, 77503, US

Leg Direction	Belt Line Road Eastbound						Belt Line Road Westbound						Driveway Northbound						Driveway Southbound						Int
	L	T	R	U	App	Ped*	L	T	R	U	App	Ped*	L	T	R	U	App	Ped*	L	T	R	U	App	Ped*	
2021-05-12 7:30AM	0	129	0	0	129	0	2	226	0	0	228	0	1	0	0	0	1	0	3	1	3	0	7	1	365
7:45AM	0	154	0	1	155	0	1	266	3	0	270	0	0	0	0	0	0	1	1	0	2	0	3	0	428
8:00AM	1	98	0	0	99	0	5	251	5	0	261	0	0	0	0	0	0	1	1	0	0	0	1	1	361
8:15AM	2	134	0	1	137	0	3	205	3	0	211	0	0	0	0	0	0	0	1	0	2	0	3	0	351
<b>Total</b>	3	515	0	2	520	0	11	948	11	0	970	0	1	0	0	0	1	2	6	1	7	0	14	2	1505
<b>% Approach</b>	0.6%	99.0%	0%	0.4%	-	-	1.1%	97.7%	1.1%	0%	-	-	100%	0%	0%	0%	-	-	42.9%	7.1%	50.0%	0%	-	-	-
<b>% Total</b>	0.2%	34.2%	0%	0.1%	34.6%	-	0.7%	63.0%	0.7%	0%	64.5%	-	0.1%	0%	0%	0%	0.1%	-	0.4%	0.1%	0.5%	0%	0.9%	-	-
<b>PHF</b>	0.375	0.836	-	0.500	0.839	-	0.550	0.891	0.550	-	0.898	-	0.250	-	-	-	0.250	-	0.500	0.250	0.583	-	0.500	-	0.879
<b>Lights</b>	3	505	0	2	510	-	11	937	11	0	959	-	1	0	0	0	1	-	6	1	6	0	13	-	1483
<b>% Lights</b>	100%	98.1%	0%	100%	98.1%	-	100%	98.8%	100%	0%	98.9%	-	100%	0%	0%	0%	100%	-	100%	100%	85.7%	0%	92.9%	-	98.5%
<b>Articulated Trucks</b>	0	1	0	0	1	-	0	0	0	0	0	-	0	0	0	0	0	-	0	0	0	0	0	-	1
<b>% Articulated Trucks</b>	0%	0.2%	0%	0%	0.2%	-	0%	0%	0%	0%	0%	-	0%	0%	0%	0%	0%	-	0%	0%	0%	0%	0%	-	0.1%
<b>Buses and Single-Unit Trucks</b>	0	9	0	0	9	-	0	11	0	0	11	-	0	0	0	0	0	-	0	0	1	0	1	-	21
<b>% Buses and Single-Unit Trucks</b>	0%	1.7%	0%	0%	1.7%	-	0%	1.2%	0%	0%	1.1%	-	0%	0%	0%	0%	0%	-	0%	0%	14.3%	0%	7.1%	-	1.4%
<b>Pedestrians</b>	-	-	-	-	-	0	-	-	-	-	-	0	-	-	-	-	-	2	-	-	-	-	-	2	
<b>% Pedestrians</b>	-	-	-	-	-	-	-	-	-	-	-	-	-	-	-	-	-	100%	-	-	-	-	-	100%	-
<b>Bicycles on Crosswalk</b>	-	-	-	-	-	0	-	-	-	-	-	0	-	-	-	-	-	0	-	-	-	-	-	0	
<b>% Bicycles on Crosswalk</b>	-	-	-	-	-	-	-	-	-	-	-	-	-	-	-	-	-	0%	-	-	-	-	-	0%	-

\* Pedestrians and Bicycles on Crosswalk. L: Left, R: Right, T: Thru, U: U-Turn

5. Belt Line Road at Median Opening - TMC

Wed May 12, 2021

PM Peak (5 PM - 6 PM) - Overall Peak Hour

All Classes (Lights, Articulated Trucks, Buses and Single-Unit Trucks, Pedestrians, Bicycles on Crosswalk)

All Movements

ID: 835144, Location: 32.951091, -96.799995



Provided by: C. J. Hensch & Associates Inc.

5215 Sycamore Ave., Pasadena, TX, 77503, US

Leg Direction	Belt Line Road Eastbound						Belt Line Road Westbound						Driveway Northbound						Driveway Southbound						Int
	L	T	R	U	App	Ped*	L	T	R	U	App	Ped*	L	T	R	U	App	Ped*	L	T	R	U	App	Ped*	
2021-05-12 5:00PM	1	295	2	1	299	0	4	188	2	1	195	0	1	1	4	0	6	0	1	0	1	0	2	1	502
5:15PM	1	309	0	0	310	0	8	213	2	0	223	0	0	0	3	0	3	0	0	0	3	0	3	0	539
5:30PM	2	277	0	1	280	0	3	194	0	0	197	0	2	1	1	0	4	0	1	1	3	0	5	0	486
5:45PM	0	270	0	2	272	0	8	201	7	1	217	0	0	2	3	0	5	0	2	0	0	0	2	0	496
<b>Total</b>	4	1151	2	4	1161	0	23	796	11	2	832	0	3	4	11	0	18	0	4	1	7	0	12	1	2023
<b>% Approach</b>	0.3%	99.1%	0.2%	0.3%	-	-	2.8%	95.7%	1.3%	0.2%	-	-	16.7%	22.2%	61.1%	0%	-	-	33.3%	8.3%	58.3%	0%	-	-	-
<b>% Total</b>	0.2%	56.9%	0.1%	0.2%	57.4%	-	1.1%	39.3%	0.5%	0.1%	41.1%	-	0.1%	0.2%	0.5%	0%	0.9%	-	0.2%	0%	0.3%	0%	0.6%	-	-
<b>PHF</b>	0.500	0.931	0.250	0.500	0.936	-	0.719	0.934	0.393	0.500	0.933	-	0.375	0.500	0.688	-0.750	-	-	-	-	-	-	-	0.938	
<b>Lights</b>	4	1144	2	4	1154	-	23	790	11	2	826	-	3	4	11	0	18	-	4	1	7	0	12	-	2010
<b>% Lights</b>	100%	99.4%	100%	100%	99.4%	-	100%	99.2%	100%	100%	99.3%	-	100%	100%	100%	0%	100%	-	100%	100%	100%	0%	100%	-	99.4%
<b>Articulated Trucks</b>	0	1	0	0	1	-	0	1	0	0	1	-	0	0	0	0	0	-	0	0	0	0	0	-	2
<b>% Articulated Trucks</b>	0%	0.1%	0%	0%	0.1%	-	0%	0.1%	0%	0%	0.1%	-	0%	0%	0%	0%	0%	-	0%	0%	0%	0%	0%	-	0.1%
<b>Buses and Single-Unit Trucks</b>	0	6	0	0	6	-	0	5	0	0	5	-	0	0	0	0	0	-	0	0	0	0	0	-	11
<b>% Buses and Single-Unit Trucks</b>	0%	0.5%	0%	0%	0.5%	-	0%	0.6%	0%	0%	0.6%	-	0%	0%	0%	0%	0%	-	0%	0%	0%	0%	0%	-	0.5%
<b>Pedestrians</b>	-	-	-	-	-	0	-	-	-	-	-	0	-	-	-	-	-	0	-	-	-	-	-	1	-
<b>% Pedestrians</b>	-	-	-	-	-	-	-	-	-	-	-	-	-	-	-	-	-	-	-	-	-	-	-	-	100%
<b>Bicycles on Crosswalk</b>	-	-	-	-	-	0	-	-	-	-	-	0	-	-	-	-	-	0	-	-	-	-	-	0	-
<b>% Bicycles on Crosswalk</b>	-	-	-	-	-	-	-	-	-	-	-	-	-	-	-	-	-	-	-	-	-	-	-	-	0%

\*Pedestrians and Bicycles on Crosswalk. L: Left, R: Right, T: Thru, U: U-Turn

**6. Belt Line Road at Alexis Drive - TMC**

Wed May 12, 2021

Full Length (7 AM-9 AM, 4:30 PM-6:30 PM)

All Classes (Lights, Articulated Trucks, Buses and Single-Unit Trucks, Pedestrians, Bicycles on Crosswalk)

All Movements

ID: 835145, Location: 32.950002, -96.798513



Provided by: C. J. Hensch & Associates Inc.

5215 Sycamore Ave.,  
Pasadena, TX, 77503, US

Leg Direction	Belt Line Road Eastbound					Belt Line Road Westbound					Alexis Drive Northbound					Int
	T	R	U	App	Ped*	L	T	U	App	Ped*	L	R	U	App	Ped*	
2021-05-12 7:00AM	70	2	0	72	0	28	120	0	148	0	0	17	0	17	0	237
7:15AM	103	1	0	104	0	33	192	0	225	0	0	17	0	17	0	346
7:30AM	132	0	0	132	0	22	225	0	247	0	1	24	0	25	0	404
7:45AM	156	2	0	158	0	47	269	0	316	0	0	27	0	27	2	501
Hourly Total	461	5	0	466	0	130	806	0	936	0	1	85	0	86	2	1488
8:00AM	96	1	0	97	0	35	257	0	292	0	1	22	0	23	1	412
8:15AM	134	0	0	134	0	35	203	0	238	0	0	34	0	34	0	406
8:30AM	118	1	1	120	0	36	173	0	209	0	0	23	0	23	1	352
8:45AM	85	2	0	87	0	40	239	0	279	0	1	27	0	28	0	394
Hourly Total	433	4	1	438	0	146	872	0	1018	0	2	106	0	108	2	1564
4:30PM	268	3	1	272	0	45	200	0	245	0	0	80	0	80	0	597
4:45PM	234	1	0	235	1	44	205	0	249	0	4	84	0	88	0	572
Hourly Total	502	4	1	507	1	89	405	0	494	0	4	164	0	168	0	1169
5:00PM	297	3	0	300	0	33	197	0	230	0	0	73	0	73	0	603
5:15PM	295	1	0	296	0	49	215	0	264	0	0	76	0	76	0	636
5:30PM	284	5	0	289	0	46	206	2	254	0	0	68	0	68	0	611
5:45PM	266	1	1	268	0	45	205	0	250	0	1	59	0	60	0	578
Hourly Total	1142	10	1	1153	0	173	823	2	998	0	1	276	0	277	0	2428
6:00PM	211	5	1	217	0	50	213	0	263	0	0	65	0	65	0	545
6:15PM	231	4	0	235	0	38	197	0	235	0	1	56	0	57	0	527
Hourly Total	442	9	1	452	0	88	410	0	498	0	1	121	0	122	0	1072
<b>Total</b>	2980	32	4	3016	1	626	3316	2	3944	0	9	752	0	761	4	7721
<b>% Approach</b>	98.8%	1.1%	0.1%	-	-	15.9%	84.1%	0.1%	-	-	1.2%	98.8%	0%	-	-	-
<b>% Total</b>	38.6%	0.4%	0.1%	39.1%	-	8.1%	42.9%	0%	51.1%	-	0.1%	9.7%	0%	9.9%	-	-
<b>Lights</b>	2937	32	4	2973	-	623	3277	2	3902	-	9	750	0	759	-	7634
<b>% Lights</b>	98.6%	100%	100%	98.6%	-	99.5%	98.8%	100%	98.9%	-	100%	99.7%	0%	99.7%	-	98.9%
<b>Articulated Trucks</b>	5	0	0	5	-	0	4	0	4	-	0	0	0	0	-	9
<b>% Articulated Trucks</b>	0.2%	0%	0%	0.2%	-	0%	0.1%	0%	0.1%	-	0%	0%	0%	0%	-	0.1%
<b>Buses and Single-Unit Trucks</b>	38	0	0	38	-	3	35	0	38	-	0	2	0	2	-	78
<b>% Buses and Single-Unit Trucks</b>	1.3%	0%	0%	1.3%	-	0.5%	1.1%	0%	1.0%	-	0%	0.3%	0%	0.3%	-	1.0%
<b>Pedestrians</b>	-	-	-	-	1	-	-	-	-	0	-	-	-	-	-	4
<b>% Pedestrians</b>	-	-	-	-	100%	-	-	-	-	-	-	-	-	-	-	100%
<b>Bicycles on Crosswalk</b>	-	-	-	-	0	-	-	-	-	0	-	-	-	-	-	0
<b>% Bicycles on Crosswalk</b>	-	-	-	-	0%	-	-	-	-	-	-	-	-	-	-	0%

\*Pedestrians and Bicycles on Crosswalk. L: Left, R: Right, T: Thru, U: U-Turn



**6. Belt Line Road at Alexis Drive - TMC**

Wed May 12, 2021

AM Peak (7:30 AM - 8:30 AM)

All Classes (Lights, Articulated Trucks, Buses and Single-Unit Trucks, Pedestrians, Bicycles on Crosswalk)

All Movements

ID: 835145, Location: 32.950002, -96.798513



Provided by: C. J. Hensch & Associates Inc.

5215 Sycamore Ave.,  
Pasadena, TX, 77503, US

Leg Direction	Belt Line Road Eastbound					Belt Line Road Westbound					Alexis Drive Northbound					Int
	T	R	U	App	Ped*	L	T	U	App	Ped*	L	R	U	App	Ped*	
2021-05-12 7:30AM	132	0	0	132	0	22	225	0	247	0	1	24	0	25	0	404
7:45AM	156	2	0	158	0	47	269	0	316	0	0	27	0	27	2	501
8:00AM	96	1	0	97	0	35	257	0	292	0	1	22	0	23	1	412
8:15AM	134	0	0	134	0	35	203	0	238	0	0	34	0	34	0	406
<b>Total</b>	518	3	0	521	0	139	954	0	1093	0	2	107	0	109	3	1723
<b>% Approach</b>	99.4%	0.6%	0%	-	-	12.7%	87.3%	0%	-	-	1.8%	98.2%	0%	-	-	-
<b>% Total</b>	30.1%	0.2%	0%	30.2%	-	8.1%	55.4%	0%	63.4%	-	0.1%	6.2%	0%	6.3%	-	-
<b>PHF</b>	0.830	0.375	-	0.824	-	0.739	0.887	-	0.865	-	0.500	0.787	-	0.801	-	0.860
<b>Lights</b>	508	3	0	511	-	139	944	0	1083	-	2	107	0	109	-	1703
<b>% Lights</b>	98.1%	100%	0%	98.1%	-	100%	99.0%	0%	99.1%	-	100%	100%	0%	100%	-	98.8%
<b>Articulated Trucks</b>	2	0	0	2	-	0	0	0	0	-	0	0	0	0	-	2
<b>% Articulated Trucks</b>	0.4%	0%	0%	0.4%	-	0%	0%	0%	0%	-	0%	0%	0%	0%	-	0.1%
<b>Buses and Single-Unit Trucks</b>	8	0	0	8	-	0	10	0	10	-	0	0	0	0	-	18
<b>% Buses and Single-Unit Trucks</b>	1.5%	0%	0%	1.5%	-	0%	1.0%	0%	0.9%	-	0%	0%	0%	0%	-	1.0%
Pedestrians	-	-	-	-	0	-	-	-	-	0	-	-	-	-	3	-
% Pedestrians	-	-	-	-	-	-	-	-	-	-	-	-	-	-	100%	-
Bicycles on Crosswalk	-	-	-	-	0	-	-	-	-	0	-	-	-	-	0	-
% Bicycles on Crosswalk	-	-	-	-	-	-	-	-	-	-	-	-	-	-	0%	-

\*Pedestrians and Bicycles on Crosswalk. L: Left, R: Right, T: Thru, U: U-Turn

**6. Belt Line Road at Alexis Drive - TMC**

Wed May 12, 2021

PM Peak (5 PM - 6 PM) - Overall Peak Hour

All Classes (Lights, Articulated Trucks, Buses and Single-Unit Trucks, Pedestrians, Bicycles on Crosswalk)

All Movements

ID: 835145, Location: 32.950002, -96.798513



Provided by: C. J. Hensch & Associates Inc.

5215 Sycamore Ave.,  
Pasadena, TX, 77503, US

Leg Direction	Belt Line Road Eastbound					Belt Line Road Westbound					Alexis Drive Northbound					Int
	T	R	U	App	Ped*	L	T	U	App	Ped*	L	R	U	App	Ped*	
2021-05-12 5:00PM	297	3	0	<b>300</b>	0	33	197	0	<b>230</b>	0	0	73	0	<b>73</b>	0	<b>603</b>
5:15PM	295	1	0	<b>296</b>	0	49	215	0	<b>264</b>	0	0	76	0	<b>76</b>	0	<b>636</b>
5:30PM	284	5	0	<b>289</b>	0	46	206	2	<b>254</b>	0	0	68	0	<b>68</b>	0	<b>611</b>
5:45PM	266	1	1	<b>268</b>	0	45	205	0	<b>250</b>	0	1	59	0	<b>60</b>	0	<b>578</b>
<b>Total</b>	1142	10	1	<b>1153</b>	0	173	823	2	<b>998</b>	0	1	276	0	<b>277</b>	0	<b>2428</b>
<b>% Approach</b>	99.0%	0.9%	0.1%	-	-	17.3%	82.5%	0.2%	-	-	0.4%	99.6%	0%	-	-	-
<b>% Total</b>	47.0%	0.4%	0%	<b>47.5%</b>	-	7.1%	33.9%	0.1%	<b>41.1%</b>	-	0%	11.4%	0%	<b>11.4%</b>	-	-
<b>PHF</b>	0.961	0.500	0.250	<b>0.961</b>	-	0.883	0.957	0.250	<b>0.945</b>	-	0.250	0.908	-	<b>0.911</b>	-	0.954
<b>Lights</b>	1134	10	1	<b>1145</b>	-	172	817	2	<b>991</b>	-	1	275	0	<b>276</b>	-	2412
<b>% Lights</b>	99.3%	100%	100%	<b>99.3%</b>	-	99.4%	99.3%	100%	<b>99.3%</b>	-	100%	99.6%	0%	<b>99.6%</b>	-	99.3%
<b>Articulated Trucks</b>	1	0	0	<b>1</b>	-	0	1	0	<b>1</b>	-	0	0	0	<b>0</b>	-	2
<b>% Articulated Trucks</b>	0.1%	0%	0%	<b>0.1%</b>	-	0%	0.1%	0%	<b>0.1%</b>	-	0%	0%	0%	<b>0%</b>	-	0.1%
<b>Buses and Single-Unit Trucks</b>	7	0	0	<b>7</b>	-	1	5	0	<b>6</b>	-	0	1	0	<b>1</b>	-	14
<b>% Buses and Single-Unit Trucks</b>	0.6%	0%	0%	<b>0.6%</b>	-	0.6%	0.6%	0%	<b>0.6%</b>	-	0%	0.4%	0%	<b>0.4%</b>	-	0.6%
Pedestrians	-	-	-	-	0	-	-	-	-	0	-	-	-	-	0	-
% Pedestrians	-	-	-	-	-	-	-	-	-	-	-	-	-	-	-	-
Bicycles on Crosswalk	-	-	-	-	0	-	-	-	-	0	-	-	-	-	0	-
% Bicycles on Crosswalk	-	-	-	-	-	-	-	-	-	-	-	-	-	-	-	-

\*Pedestrians and Bicycles on Crosswalk. L: Left, R: Right, T: Thru, U: U-Turn

7. Belt Line Road at Meadowcreek Drive - TMC

Wed May 12, 2021

Full Length (7 AM-9 AM, 4:30 PM-6:30 PM)

All Classes (Lights, Articulated Trucks, Buses and Single-Unit Trucks, Pedestrians, Bicycles on Crosswalk)

All Movements

ID: 835146, Location: 32.950031, -96.792457



Provided by: C. J. Hensch & Associates Inc.  
5215 Sycamore Ave.,  
Pasadena, TX, 77503, US

Leg Direction	Belt Line Road Eastbound						Belt Line Road Westbound						Meadowcreek Drive Northbound						Meadowcreek Drive Southbound						Int
	L	T	R	U	App	Ped*	L	T	R	U	App	Ped*	L	T	R	U	App	Ped*	L	T	R	U	App	Ped*	
2021-05-12 7:00AM	4	78	1	0	83	0	1	106	1	0	108	0	1	0	0	0	1	0	1	0	17	0	18	0	210
7:15AM	6	110	2	0	118	0	0	200	3	0	203	0	2	0	0	0	2	0	6	0	19	0	25	0	348
7:30AM	2	147	1	0	150	1	1	237	4	0	242	0	8	1	4	0	13	0	2	1	21	0	24	0	429
7:45AM	9	166	7	0	182	0	1	250	3	0	254	0	6	0	1	0	7	0	2	3	18	0	23	0	466
Hourly Total	21	501	11	0	533	1	3	793	11	0	807	0	17	1	5	0	23	0	11	4	75	0	90	0	1453
8:00AM	6	110	2	0	118	0	0	267	7	0	274	0	3	1	0	0	4	2	2	4	23	0	29	0	425
8:15AM	10	144	5	1	160	0	1	223	2	0	226	0	2	1	1	0	4	0	2	1	14	0	17	0	407
8:30AM	4	121	5	0	130	0	1	183	5	0	189	1	3	4	2	0	9	1	0	5	7	0	12	0	340
8:45AM	3	96	6	0	105	0	2	250	3	0	255	0	0	1	2	0	3	0	1	2	18	0	21	0	384
Hourly Total	23	471	18	1	513	0	4	923	17	0	944	1	8	7	5	0	20	3	5	12	62	0	79	0	1556
4:30PM	25	266	9	1	301	0	3	207	2	1	213	0	3	6	1	0	10	0	2	2	12	0	16	0	540
4:45PM	20	283	14	0	317	0	3	214	4	0	221	0	5	3	3	0	11	1	1	1	16	0	18	0	567
Hourly Total	45	549	23	1	618	0	6	421	6	1	434	0	8	9	4	0	21	1	3	3	28	0	34	0	1107
5:00PM	26	318	9	1	354	0	3	201	6	0	210	0	3	4	2	0	9	0	4	1	10	0	15	0	588
5:15PM	14	316	11	0	341	0	1	238	3	0	242	0	4	2	4	0	10	0	5	2	15	0	22	0	615
5:30PM	21	326	8	1	356	0	0	247	4	0	251	0	5	2	0	0	7	0	2	1	15	0	18	0	632
5:45PM	28	268	11	0	307	0	1	199	7	0	207	0	12	7	6	0	25	1	1	0	18	0	19	0	558
Hourly Total	89	1228	39	2	1358	0	5	885	20	0	910	0	24	15	12	0	51	1	12	4	58	0	74	0	2393
6:00PM	19	235	9	0	263	0	1	237	2	1	241	0	10	7	1	0	18	0	2	1	14	0	17	0	539
6:15PM	12	248	9	0	269	0	1	224	3	0	228	0	5	1	2	0	8	0	4	4	19	0	27	0	532
Hourly Total	31	483	18	0	532	0	2	461	5	1	469	0	15	8	3	0	26	0	6	5	33	0	44	0	1071
<b>Total</b>	209	3232	109	4	3554	1	20	3483	59	2	3564	1	72	40	29	0	141	5	37	28	256	0	321	0	7580
<b>% Approach</b>	5.9%	90.9%	3.1%	0.1%	-	-	0.6%	97.7%	1.7%	0.1%	-	-	51.1%	28.4%	20.6%	0%	-	-	11.5%	8.7%	79.8%	0%	-	-	-
<b>% Total</b>	2.8%	42.6%	1.4%	0.1%	46.9%	-	0.3%	45.9%	0.8%	0%	47.0%	-	0.9%	0.5%	0.4%	0%	1.9%	-	0.5%	0.4%	3.4%	0%	4.2%	-	-
<b>Lights</b>	207	3189	109	4	3509	-	18	3446	57	2	3523	-	71	39	28	0	138	-	37	26	254	0	317	-	7487
<b>% Lights</b>	99.0%	98.7%	100%	100%	98.7%	-	90.0%	98.9%	96.6%	100%	98.8%	-	98.6%	97.5%	96.6%	0%	97.9%	-	100%	92.9%	99.2%	0%	98.8%	-	98.8%
<b>Articulated Trucks</b>	0	4	0	0	4	-	0	5	0	0	5	-	0	0	0	0	0	-	0	0	0	0	0	-	9
<b>% Articulated Trucks</b>	0%	0.1%	0%	0%	0.1%	-	0%	0.1%	0%	0%	0.1%	-	0%	0%	0%	0%	0%	-	0%	0%	0%	0%	0%	-	0.1%
<b>Buses and Single-Unit Trucks</b>	2	39	0	0	41	-	2	32	2	0	36	-	1	1	1	0	3	-	0	2	2	0	4	-	84
<b>% Buses and Single-Unit Trucks</b>	1.0%	1.2%	0%	0%	1.2%	-	10.0%	0.9%	3.4%	0%	1.0%	-	1.4%	2.5%	3.4%	0%	2.1%	-	0%	7.1%	0.8%	0%	1.2%	-	1.1%
<b>Pedestrians</b>	-	-	-	-	-	1	-	-	-	-	-	1	-	-	-	-	-	4	-	-	-	-	-	0	-
<b>% Pedestrians</b>	-	-	-	-	-	100%	-	-	-	-	-	100%	-	-	-	-	-	80.0%	-	-	-	-	-	-	-
<b>Bicycles on Crosswalk</b>	-	-	-	-	-	0	-	-	-	-	-	0	-	-	-	-	-	1	-	-	-	-	-	0	-
<b>% Bicycles on Crosswalk</b>	-	-	-	-	-	0%	-	-	-	-	-	0%	-	-	-	-	-	20.0%	-	-	-	-	-	-	-

\*Pedestrians and Bicycles on Crosswalk. L: Left, R: Right, T: Thru, U: U-Turn

7. Belt Line Road at Meadowcreek Drive - TMC

Wed May 12, 2021

AM Peak (7:30 AM - 8:30 AM)

All Classes (Lights, Articulated Trucks, Buses and Single-Unit Trucks, Pedestrians, Bicycles on Crosswalk)

All Movements

ID: 835146, Location: 32.950031, -96.792457



Provided by: C. J. Hensch & Associates Inc.

5215 Sycamore Ave., Pasadena, TX, 77503, US

Leg Direction	Belt Line Road Eastbound						Belt Line Road Westbound						Meadowcreek Drive Northbound						Meadowcreek Drive Southbound						Int
	L	T	R	U	App	Ped*	L	T	R	U	App	Ped*	L	T	R	U	App	Ped*	L	T	R	U	App	Ped*	
2021-05-12 7:30AM	2	147	1	0	150	1	1	237	4	0	242	0	8	1	4	0	13	0	2	1	21	0	24	0	429
7:45AM	9	166	7	0	182	0	1	250	3	0	254	0	6	0	1	0	7	0	2	3	18	0	23	0	466
8:00AM	6	110	2	0	118	0	0	267	7	0	274	0	3	1	0	0	4	2	2	4	23	0	29	0	425
8:15AM	10	144	5	1	160	0	1	223	2	0	226	0	2	1	1	0	4	0	2	1	14	0	17	0	407
<b>Total</b>	27	567	15	1	610	1	3	977	16	0	996	0	19	3	6	0	28	2	8	9	76	0	93	0	1727
<b>% Approach</b>	4.4%	93.0%	2.5%	0.2%	-	-	0.3%	98.1%	1.6%	0%	-	-	67.9%	10.7%	21.4%	0%	-	-	8.6%	9.7%	81.7%	0%	-	-	-
<b>% Total</b>	1.6%	32.8%	0.9%	0.1%	35.3%	-	0.2%	56.6%	0.9%	0%	57.7%	-	1.1%	0.2%	0.3%	0%	1.6%	-	0.5%	0.5%	4.4%	0%	5.4%	-	-
<b>PHF</b>	0.675	0.854	0.536	0.250	0.838	-	0.750	0.915	0.571	-	0.909	-	0.594	0.750	0.375	-	0.538	-	1.000	0.563	0.826	-	0.802	-	0.927
<b>Lights</b>	27	558	15	1	601	-	3	968	15	0	986	-	19	3	6	0	28	-	8	9	76	0	93	-	1708
<b>% Lights</b>	100%	98.4%	100%	100%	98.5%	-	100%	99.1%	93.8%	0%	99.0%	-	100%	100%	100%	0%	100%	-	100%	100%	100%	0%	100%	-	98.9%
<b>Articulated Trucks</b>	0	1	0	0	1	-	0	0	0	0	0	-	0	0	0	0	0	-	0	0	0	0	0	-	1
<b>% Articulated Trucks</b>	0%	0.2%	0%	0%	0.2%	-	0%	0%	0%	0%	0%	-	0%	0%	0%	0%	0%	-	0%	0%	0%	0%	0%	-	0.1%
<b>Buses and Single-Unit Trucks</b>	0	8	0	0	8	-	0	9	1	0	10	-	0	0	0	0	0	-	0	0	0	0	0	-	18
<b>% Buses and Single-Unit Trucks</b>	0%	1.4%	0%	0%	1.3%	-	0%	0.9%	6.3%	0%	1.0%	-	0%	0%	0%	0%	0%	-	0%	0%	0%	0%	0%	-	1.0%
Pedestrians	-	-	-	-	-	1	-	-	-	-	-	0	-	-	-	-	-	2	-	-	-	-	-	0	
% Pedestrians	-	-	-	-	-	100%	-	-	-	-	-	-	-	-	-	-	-	100%	-	-	-	-	-	-	
Bicycles on Crosswalk	-	-	-	-	-	0	-	-	-	-	-	0	-	-	-	-	-	0	-	-	-	-	-	0	
% Bicycles on Crosswalk	-	-	-	-	-	0%	-	-	-	-	-	-	-	-	-	-	-	0%	-	-	-	-	-	-	

\*Pedestrians and Bicycles on Crosswalk. L: Left, R: Right, T: Thru, U: U-Turn

7. Belt Line Road at Meadowcreek Drive - TMC

Wed May 12, 2021

PM Peak (4:45 PM - 5:45 PM) - Overall Peak Hour

All Classes (Lights, Articulated Trucks, Buses and Single-Unit Trucks, Pedestrians, Bicycles on Crosswalk)

All Movements

ID: 835146, Location: 32.950031, -96.792457



Provided by: C. J. Hensch & Associates Inc.

5215 Sycamore Ave.,  
Pasadena, TX, 77503, US

Leg Direction	Belt Line Road Eastbound						Belt Line Road Westbound						Meadowcreek Drive Northbound						Meadowcreek Drive Southbound						Int
	L	T	R	U	App	Ped*	L	T	R	U	App	Ped*	L	T	R	U	App	Ped*	L	T	R	U	App	Ped*	
2021-05-12 4:45PM	20	283	14	0	317	0	3	214	4	0	221	0	5	3	3	0	11	1	1	1	16	0	18	0	567
5:00PM	26	318	9	1	354	0	3	201	6	0	210	0	3	4	2	0	9	0	4	1	10	0	15	0	588
5:15PM	14	316	11	0	341	0	1	238	3	0	242	0	4	2	4	0	10	0	5	2	15	0	22	0	615
5:30PM	21	326	8	1	356	0	0	247	4	0	251	0	5	2	0	0	7	0	2	1	15	0	18	0	632
<b>Total</b>	81	1243	42	2	1368	0	7	900	17	0	924	0	17	11	9	0	37	1	12	5	56	0	73	0	2402
<b>% Approach</b>	5.9%	90.9%	3.1%	0.1%	-	-	0.8%	97.4%	1.8%	0%	-	-	45.9%	29.7%	24.3%	0%	-	-	16.4%	6.8%	76.7%	0%	-	-	-
<b>% Total</b>	3.4%	51.7%	1.7%	0.1%	57.0%	-	0.3%	37.5%	0.7%	0%	38.5%	-	0.7%	0.5%	0.4%	0%	1.5%	-	0.5%	0.2%	2.3%	0%	3.0%	-	-
<b>PHF</b>	0.779	0.953	0.750	0.500	0.961	-	0.583	0.911	0.708	-	0.920	-	0.850	0.688	0.563	-	0.841	-	0.600	0.625	0.875	-	0.830	-	0.950
<b>Lights</b>	80	1228	42	2	1352	-	6	894	17	0	917	-	17	10	8	0	35	-	12	5	55	0	72	-	2376
<b>% Lights</b>	98.8%	98.8%	100%	100%	98.8%	-	85.7%	99.3%	100%	0%	99.2%	-	100%	90.9%	88.9%	0%	94.6%	-	100%	100%	98.2%	0%	98.6%	-	98.9%
<b>Articulated Trucks</b>	0	0	0	0	0	-	0	1	0	0	1	-	0	0	0	0	0	-	0	0	0	0	0	-	1
<b>% Articulated Trucks</b>	0%	0%	0%	0%	0%	-	0%	0.1%	0%	0%	0.1%	-	0%	0%	0%	0%	0%	-	0%	0%	0%	0%	0%	-	0%
<b>Buses and Single-Unit Trucks</b>	1	15	0	0	16	-	1	5	0	0	6	-	0	1	1	0	2	-	0	0	1	0	1	-	25
<b>% Buses and Single-Unit Trucks</b>	1.2%	1.2%	0%	0%	1.2%	-	14.3%	0.6%	0%	0%	0.6%	-	0%	9.1%	11.1%	0%	5.4%	-	0%	0%	1.8%	0%	1.4%	-	1.0%
<b>Pedestrians</b>	-	-	-	-	-	0	-	-	-	-	-	0	-	-	-	-	-	1	-	-	-	-	-	0	-
<b>% Pedestrians</b>	-	-	-	-	-	-	-	-	-	-	-	-	-	-	-	-	-	100%	-	-	-	-	-	-	-
<b>Bicycles on Crosswalk</b>	-	-	-	-	-	0	-	-	-	-	-	0	-	-	-	-	-	0	-	-	-	-	-	0	-
<b>% Bicycles on Crosswalk</b>	-	-	-	-	-	-	-	-	-	-	-	-	-	-	-	-	-	0%	-	-	-	-	-	-	-

\*Pedestrians and Bicycles on Crosswalk. L: Left, R: Right, T: Thru, U: U-Turn

**8. Arapaho Road at Preston Road - TMC**

Wed May 12, 2021

Full Length (7 AM-9 AM, 4:30 PM-6:30 PM)

All Classes (Lights, Articulated Trucks, Buses and Single-Unit Trucks, Pedestrians, Bicycles on Crosswalk)

All Movements

ID: 835147, Location: 32.9623, -96.804495



Provided by: C. J. Hensch & Associates Inc.  
5215 Sycamore Ave.,  
Pasadena, TX, 77503, US

Leg Direction	Arapaho Road Eastbound						Arapaho Road Westbound						Preston Road Northbound						Preston Road Southbound						Int
	L	T	R	U	App	Ped*	L	T	R	U	App	Ped*	L	T	R	U	App	Ped*	L	T	R	U	App	Ped*	
2021-05-12 7:00AM	13	49	26	0	<b>88</b>	0	15	86	19	0	<b>120</b>	0	14	205	7	0	<b>226</b>	0	9	282	26	1	<b>318</b>	0	<b>752</b>
7:15AM	23	60	40	0	<b>123</b>	0	15	126	20	0	<b>161</b>	0	11	238	8	0	<b>257</b>	0	16	353	24	1	<b>394</b>	0	<b>935</b>
7:30AM	27	69	40	2	<b>138</b>	0	28	185	41	0	<b>254</b>	0	20	307	20	0	<b>347</b>	0	18	389	43	2	<b>452</b>	0	<b>1191</b>
7:45AM	27	60	29	1	<b>117</b>	1	27	166	39	0	<b>232</b>	0	28	423	22	0	<b>473</b>	0	25	446	62	0	<b>533</b>	0	<b>1355</b>
Hourly Total	90	238	135	3	<b>466</b>	1	85	563	119	0	<b>767</b>	0	73	1173	57	0	<b>1303</b>	0	68	1470	155	4	<b>1697</b>	0	<b>4233</b>
8:00AM	33	57	34	0	<b>124</b>	0	31	188	50	0	<b>269</b>	1	29	410	12	1	<b>452</b>	0	35	406	51	0	<b>492</b>	0	<b>1337</b>
8:15AM	35	48	30	0	<b>113</b>	0	23	129	25	0	<b>177</b>	0	22	385	20	0	<b>427</b>	0	18	483	49	2	<b>552</b>	0	<b>1269</b>
8:30AM	23	72	37	0	<b>132</b>	0	26	152	27	0	<b>205</b>	0	25	316	18	1	<b>360</b>	0	25	379	56	1	<b>461</b>	0	<b>1158</b>
8:45AM	30	71	34	0	<b>135</b>	1	24	139	35	0	<b>198</b>	0	24	273	24	1	<b>322</b>	0	33	275	61	1	<b>370</b>	1	<b>1025</b>
Hourly Total	121	248	135	0	<b>504</b>	1	104	608	137	0	<b>849</b>	1	100	1384	74	3	<b>1561</b>	0	111	1543	217	4	<b>1875</b>	1	<b>4789</b>
4:30PM	61	157	37	0	<b>255</b>	0	37	107	33	1	<b>178</b>	0	42	436	34	1	<b>513</b>	0	50	373	54	1	<b>478</b>	0	<b>1424</b>
4:45PM	60	193	40	0	<b>293</b>	0	30	108	29	0	<b>167</b>	0	35	443	43	1	<b>522</b>	0	46	306	46	0	<b>398</b>	1	<b>1380</b>
Hourly Total	121	350	77	0	<b>548</b>	0	67	215	62	1	<b>345</b>	0	77	879	77	2	<b>1035</b>	0	96	679	100	1	<b>876</b>	1	<b>2804</b>
5:00PM	65	236	44	0	<b>345</b>	0	50	161	30	0	<b>241</b>	0	47	396	35	1	<b>479</b>	0	60	306	36	0	<b>402</b>	0	<b>1467</b>
5:15PM	78	215	32	0	<b>325</b>	0	47	131	34	0	<b>212</b>	0	42	474	63	0	<b>579</b>	0	62	379	58	1	<b>500</b>	0	<b>1616</b>
5:30PM	65	231	57	1	<b>354</b>	0	24	146	43	0	<b>213</b>	0	50	448	47	1	<b>546</b>	0	39	321	34	2	<b>396</b>	0	<b>1509</b>
5:45PM	56	229	38	0	<b>323</b>	1	34	120	39	0	<b>193</b>	0	41	397	51	1	<b>490</b>	1	47	317	49	2	<b>415</b>	0	<b>1421</b>
Hourly Total	264	911	171	1	<b>1347</b>	1	155	558	146	0	<b>859</b>	0	180	1715	196	3	<b>2094</b>	1	208	1323	177	5	<b>1713</b>	0	<b>6013</b>
6:00PM	41	164	38	0	<b>243</b>	0	29	105	21	0	<b>155</b>	0	43	469	68	1	<b>581</b>	0	35	366	40	0	<b>441</b>	0	<b>1420</b>
6:15PM	68	176	34	2	<b>280</b>	0	35	120	37	0	<b>192</b>	0	37	395	56	1	<b>489</b>	0	42	279	38	1	<b>360</b>	0	<b>1321</b>
Hourly Total	109	340	72	2	<b>523</b>	0	64	225	58	0	<b>347</b>	0	80	864	124	2	<b>1070</b>	0	77	645	78	1	<b>801</b>	0	<b>2741</b>
<b>Total</b>	705	2087	590	6	<b>3388</b>	3	475	2169	522	1	<b>3167</b>	1	510	6015	528	10	<b>7063</b>	1	560	5660	727	15	<b>6962</b>	2	<b>20580</b>
<b>% Approach</b>	20.8%	61.6%	17.4%	0.2%	-	-	15.0%	68.5%	16.5%	0%	-	-	7.2%	85.2%	7.5%	0.1%	-	-	8.0%	81.3%	10.4%	0.2%	-	-	-
<b>% Total</b>	3.4%	10.1%	2.9%	0%	<b>16.5%</b>	-	2.3%	10.5%	2.5%	0%	<b>15.4%</b>	-	2.5%	29.2%	2.6%	0%	<b>34.3%</b>	-	2.7%	27.5%	3.5%	0.1%	<b>33.8%</b>	-	-
<b>Lights</b>	700	2069	573	6	<b>3348</b>	-	474	2143	517	1	<b>3135</b>	-	499	5965	522	10	<b>6996</b>	-	559	5610	724	15	<b>6908</b>	-	20387
<b>% Lights</b>	99.3%	99.1%	97.1%	100%	<b>98.8%</b>	-	99.8%	98.8%	99.0%	100%	<b>99.0%</b>	-	97.8%	99.2%	98.9%	100%	<b>99.1%</b>	-	99.8%	99.1%	99.6%	100%	<b>99.2%</b>	-	99.1%
<b>Articulated Trucks</b>	0	3	2	0	<b>5</b>	-	0	4	0	0	<b>4</b>	-	0	5	0	0	<b>5</b>	-	0	12	1	0	<b>13</b>	-	27
<b>% Articulated Trucks</b>	0%	0.1%	0.3%	0%	<b>0.1%</b>	-	0%	0.2%	0%	0%	<b>0.1%</b>	-	0%	0.1%	0%	0%	<b>0.1%</b>	-	0%	0.2%	0.1%	0%	<b>0.2%</b>	-	0.1%
<b>Buses and Single-Unit Trucks</b>	5	15	15	0	<b>35</b>	-	1	22	5	0	<b>28</b>	-	11	45	6	0	<b>62</b>	-	1	38	2	0	<b>41</b>	-	166
<b>% Buses and Single-Unit Trucks</b>	0.7%	0.7%	2.5%	0%	<b>1.0%</b>	-	0.2%	1.0%	1.0%	0%	<b>0.9%</b>	-	2.2%	0.7%	1.1%	0%	<b>0.9%</b>	-	0.2%	0.7%	0.3%	0%	<b>0.6%</b>	-	0.8%
Pedestrians	-	-	-	-	-	3	-	-	-	-	-	1	-	-	-	-	-	1	-	-	-	-	-	2	-
<b>% Pedestrians</b>	-	-	-	-	-	100%	-	-	-	-	-	100%	-	-	-	-	-	100%	-	-	-	-	-	100%	-
Bicycles on Crosswalk	-	-	-	-	-	0	-	-	-	-	-	0	-	-	-	-	-	0	-	-	-	-	-	0	-
<b>% Bicycles on Crosswalk</b>	-	-	-	-	-	0%	-	-	-	-	-	0%	-	-	-	-	-	0%	-	-	-	-	-	0%	-

\*Pedestrians and Bicycles on Crosswalk. L: Left, R: Right, T: Thru, U: U-Turn

**8. Arapaho Road at Preston Road - TMC**

Wed May 12, 2021

AM Peak (7:30 AM - 8:30 AM)

All Classes (Lights, Articulated Trucks, Buses and Single-Unit Trucks, Pedestrians, Bicycles on Crosswalk)

All Movements

ID: 835147, Location: 32.9623, -96.804495



Provided by: C. J. Hensch & Associates Inc.  
5215 Sycamore Ave.,  
Pasadena, TX, 77503, US

Leg Direction	Arapaho Road Eastbound						Arapaho Road Westbound						Preston Road Northbound						Preston Road Southbound						Int
Time	L	T	R	U	App	Ped*	L	T	R	U	App	Ped*	L	T	R	U	App	Ped*	L	T	R	U	App	Ped*	
2021-05-12 7:30AM	27	69	40	2	138	0	28	185	41	0	254	0	20	307	20	0	347	0	18	389	43	2	452	0	1191
7:45AM	27	60	29	1	117	1	27	166	39	0	232	0	28	423	22	0	473	0	25	446	62	0	533	0	1355
8:00AM	33	57	34	0	124	0	31	188	50	0	269	1	29	410	12	1	452	0	35	406	51	0	492	0	1337
8:15AM	35	48	30	0	113	0	23	129	25	0	177	0	22	385	20	0	427	0	18	483	49	2	552	0	1269
<b>Total</b>	122	234	133	3	492	1	109	668	155	0	932	1	99	1525	74	1	1699	0	96	1724	205	4	2029	0	5152
<b>% Approach</b>	24.8%	47.6%	27.0%	0.6%	-	-	11.7%	71.7%	16.6%	0%	-	-	5.8%	89.8%	4.4%	0.1%	-	-	4.7%	85.0%	10.1%	0.2%	-	-	-
<b>% Total</b>	2.4%	4.5%	2.6%	0.1%	9.5%	-	2.1%	13.0%	3.0%	0%	18.1%	-	1.9%	29.6%	1.4%	0%	33.0%	-	1.9%	33.5%	4.0%	0.1%	39.4%	-	-
<b>PHF</b>	0.871	0.848	0.831	0.375	0.891	-	0.879	0.888	0.775	-	0.866	-	0.853	0.901	0.841	0.250	0.898	-	0.686	0.892	0.827	0.500	0.919	-	0.951
<b>Lights</b>	121	230	129	3	483	-	109	664	155	0	928	-	96	1500	72	1	1669	-	96	1716	204	4	2020	-	5100
<b>% Lights</b>	99.2%	98.3%	97.0%	100%	98.2%	-	100%	99.4%	100%	0%	99.6%	-	97.0%	98.4%	97.3%	100%	98.2%	-	100%	99.5%	99.5%	100%	99.6%	-	99.0%
<b>Articulated Trucks</b>	0	0	0	0	0	-	0	2	0	0	2	-	0	1	0	0	1	-	0	4	1	0	5	-	8
<b>% Articulated Trucks</b>	0%	0%	0%	0%	0%	-	0%	0.3%	0%	0%	0.2%	-	0%	0.1%	0%	0%	0.1%	-	0%	0.2%	0.5%	0%	0.2%	-	0.2%
<b>Buses and Single-Unit Trucks</b>	1	4	4	0	9	-	0	2	0	0	2	-	3	24	2	0	29	-	0	4	0	0	4	-	44
<b>% Buses and Single-Unit Trucks</b>	0.8%	1.7%	3.0%	0%	1.8%	-	0%	0.3%	0%	0%	0.2%	-	3.0%	1.6%	2.7%	0%	1.7%	-	0%	0.2%	0%	0%	0.2%	-	0.9%
Pedestrians	-	-	-	-	-	1	-	-	-	-	-	1	-	-	-	-	-	0	-	-	-	-	-	0	
% Pedestrians	-	-	-	-	-	100%	-	-	-	-	-	100%	-	-	-	-	-	-	-	-	-	-	-	-	
Bicycles on Crosswalk	-	-	-	-	-	0	-	-	-	-	-	0	-	-	-	-	-	0	-	-	-	-	-	0	
% Bicycles on Crosswalk	-	-	-	-	-	0%	-	-	-	-	-	0%	-	-	-	-	-	-	-	-	-	-	-	-	

\*Pedestrians and Bicycles on Crosswalk. L: Left, R: Right, T: Thru, U: U-Turn

**8. Arapaho Road at Preston Road - TMC**

Wed May 12, 2021

PM Peak (5 PM - 6 PM) - Overall Peak Hour

All Classes (Lights, Articulated Trucks, Buses and Single-Unit Trucks, Pedestrians, Bicycles on Crosswalk)

All Movements

ID: 835147, Location: 32.9623, -96.804495



Provided by: C. J. Hensch & Associates Inc.  
5215 Sycamore Ave.,  
Pasadena, TX, 77503, US

Leg Direction	Arapaho Road Eastbound						Arapaho Road Westbound						Preston Road Northbound						Preston Road Southbound						Int
Time	L	T	R	U	App	Ped*	L	T	R	U	App	Ped*	L	T	R	U	App	Ped*	L	T	R	U	App	Ped*	
2021-05-12 5:00PM	65	236	44	0	345	0	50	161	30	0	241	0	47	396	35	1	479	0	60	306	36	0	402	0	1467
5:15PM	78	215	32	0	325	0	47	131	34	0	212	0	42	474	63	0	579	0	62	379	58	1	500	0	1616
5:30PM	65	231	57	1	354	0	24	146	43	0	213	0	50	448	47	1	546	0	39	321	34	2	396	0	1509
5:45PM	56	229	38	0	323	1	34	120	39	0	193	0	41	397	51	1	490	1	47	317	49	2	415	0	1421
<b>Total</b>	264	911	171	1	1347	1	155	558	146	0	859	0	180	1715	196	3	2094	1	208	1323	177	5	1713	0	6013
<b>% Approach</b>	19.6%	67.6%	12.7%	0.1%	-	-	18.0%	65.0%	17.0%	0%	-	-	8.6%	81.9%	9.4%	0.1%	-	-	12.1%	77.2%	10.3%	0.3%	-	-	-
<b>% Total</b>	4.4%	15.2%	2.8%	0%	22.4%	-	2.6%	9.3%	2.4%	0%	14.3%	-	3.0%	28.5%	3.3%	0%	34.8%	-	3.5%	22.0%	2.9%	0.1%	28.5%	-	-
<b>PHF</b>	0.846	0.965	0.750	0.250	0.951	-	0.775	0.866	0.849	-	0.891	-	0.900	0.905	0.778	0.750	0.904	-	0.839	0.873	0.763	0.625	0.857	-	0.930
<b>Lights</b>	261	908	169	1	1339	-	154	550	143	0	847	-	177	1712	196	3	2088	-	208	1303	176	5	1692	-	5966
<b>% Lights</b>	98.9%	99.7%	98.8%	100%	99.4%	-	99.4%	98.6%	97.9%	0%	98.6%	-	98.3%	99.8%	100%	100%	99.7%	-	100%	98.5%	99.4%	100%	98.8%	-	99.2%
<b>Articulated Trucks</b>	0	1	0	0	1	-	0	1	0	0	1	-	0	0	0	0	0	-	0	3	0	0	3	-	5
<b>% Articulated Trucks</b>	0%	0.1%	0%	0%	0.1%	-	0%	0.2%	0%	0%	0.1%	-	0%	0%	0%	0%	0%	-	0%	0.2%	0%	0%	0.2%	-	0.1%
<b>Buses and Single-Unit Trucks</b>	3	2	2	0	7	-	1	7	3	0	11	-	3	3	0	0	6	-	0	17	1	0	18	-	42
<b>% Buses and Single-Unit Trucks</b>	1.1%	0.2%	1.2%	0%	0.5%	-	0.6%	1.3%	2.1%	0%	1.3%	-	1.7%	0.2%	0%	0%	0.3%	-	0%	1.3%	0.6%	0%	1.1%	-	0.7%
<b>Pedestrians</b>	-	-	-	-	-	1	-	-	-	-	-	0	-	-	-	-	-	1	-	-	-	-	-	0	
<b>% Pedestrians</b>	-	-	-	-	-	100%	-	-	-	-	-	-	-	-	-	-	-	100%	-	-	-	-	-	-	
<b>Bicycles on Crosswalk</b>	-	-	-	-	-	0	-	-	-	-	-	0	-	-	-	-	-	0	-	-	-	-	-	0	
<b>% Bicycles on Crosswalk</b>	-	-	-	-	-	0%	-	-	-	-	-	-	-	-	-	-	-	0%	-	-	-	-	-	-	

\*Pedestrians and Bicycles on Crosswalk. L: Left, R: Right, T: Thru, U: U-Turn



9. Belt Line Village Driveway at Preston Road - TMC

Wed May 12, 2021

Full Length (7 AM-9 AM, 4:30 PM-6:30 PM)

All Classes (Lights, Articulated Trucks, Buses and Single-Unit Trucks, Pedestrians, Bicycles on Crosswalk)

All Movements

ID: 835148, Location: 32.95232, -96.803674



Provided by: C. J. Hensch & Associates Inc.  
5215 Sycamore Ave.,  
Pasadena, TX, 77503, US

Leg Direction	Belt Line Village Driveway Eastbound						Belt Line Village Driveway Westbound						Preston Road Northbound						Preston Road Southbound						Int
	L	T	R	U	App	Ped*	L	T	R	U	App	Ped*	L	T	R	U	App	Ped*	L	T	R	U	App	Ped*	
2021-05-12 7:00AM	5	0	4	0	9	0	1	1	0	0	2	0	1	205	0	0	206	0	1	309	4	0	314	0	531
7:15AM	5	0	8	0	13	1	1	0	0	0	1	0	3	233	1	0	237	0	0	454	3	2	459	0	710
7:30AM	4	0	3	0	7	1	0	1	0	0	1	0	3	351	1	0	355	0	1	443	7	1	452	0	815
7:45AM	13	1	4	0	18	0	1	0	0	0	1	0	7	366	1	0	374	0	3	440	11	0	454	0	847
Hourly Total	27	1	19	0	47	2	3	2	0	0	5	0	14	1155	3	0	1172	0	5	1646	25	3	1679	0	2903
8:00AM	6	0	7	0	13	0	0	1	0	0	1	0	5	433	0	0	438	0	1	499	5	0	505	0	957
8:15AM	14	0	12	0	26	0	3	0	0	0	3	0	8	436	1	0	445	0	3	519	4	2	528	0	1002
8:30AM	14	0	14	0	28	0	4	0	2	0	6	0	10	322	2	0	334	0	4	410	5	1	420	0	788
8:45AM	6	0	9	0	15	1	1	0	0	0	1	0	7	347	2	0	356	0	3	364	4	1	372	0	744
Hourly Total	40	0	42	0	82	1	8	1	2	0	11	0	30	1538	5	0	1573	0	11	1792	18	4	1825	0	3491
4:30PM	15	0	8	0	23	0	7	1	10	0	18	0	16	471	2	1	490	0	14	383	9	5	411	0	942
4:45PM	20	1	18	0	39	0	5	0	2	0	7	0	17	491	5	0	513	0	12	411	8	1	432	0	991
Hourly Total	35	1	26	0	62	0	12	1	12	0	25	0	33	962	7	1	1003	0	26	794	17	6	843	0	1933
5:00PM	21	1	12	0	34	0	5	2	6	0	13	0	21	532	5	0	558	0	10	460	4	1	475	0	1080
5:15PM	19	2	11	0	32	0	7	3	5	0	15	0	20	523	2	0	545	0	23	438	7	0	468	0	1060
5:30PM	17	1	11	0	29	0	7	1	5	0	13	0	7	574	0	1	582	0	11	444	6	6	467	0	1091
5:45PM	18	1	10	0	29	0	8	1	4	0	13	0	15	510	8	2	535	1	14	362	5	3	384	0	961
Hourly Total	75	5	44	0	124	0	27	7	20	0	54	0	63	2139	15	3	2220	1	58	1704	22	10	1794	0	4192
6:00PM	16	0	14	0	30	1	10	1	6	0	17	0	16	523	3	1	543	0	17	371	12	5	405	0	995
6:15PM	17	0	17	0	34	0	4	3	4	0	11	1	17	528	4	2	551	0	14	410	10	1	435	0	1031
Hourly Total	33	0	31	0	64	1	14	4	10	0	28	1	33	1051	7	3	1094	0	31	781	22	6	840	0	2026
<b>Total</b>	210	7	162	0	379	4	64	15	44	0	123	1	173	6845	37	7	7062	1	131	6717	104	29	6981	0	14545
<b>% Approach</b>	55.4%	1.8%	42.7%	0%	-	-	52.0%	12.2%	35.8%	0%	-	-	2.4%	96.9%	0.5%	0.1%	-	-	1.9%	96.2%	1.5%	0.4%	-	-	-
<b>% Total</b>	1.4%	0%	1.1%	0%	2.6%	-	0.4%	0.1%	0.3%	0%	0.8%	-	1.2%	47.1%	0.3%	0%	48.6%	-	0.9%	46.2%	0.7%	0.2%	48.0%	-	-
<b>Lights</b>	209	7	162	0	378	-	64	14	44	0	122	-	173	6767	36	7	6983	-	131	6655	104	29	6919	-	14402
<b>% Lights</b>	99.5%	100%	100%	0%	99.7%	-	100%	93.3%	100%	0%	99.2%	-	100%	98.9%	97.3%	100%	98.9%	-	100%	99.1%	100%	100%	99.1%	-	99.0%
<b>Articulated Trucks</b>	0	0	0	0	0	-	0	0	0	0	0	-	0	9	0	0	9	-	0	14	0	0	14	-	23
<b>% Articulated Trucks</b>	0%	0%	0%	0%	0%	-	0%	0%	0%	0%	0%	-	0%	0.1%	0%	0%	0.1%	-	0%	0.2%	0%	0%	0.2%	-	0.2%
<b>Buses and Single-Unit Trucks</b>	1	0	0	0	1	-	0	1	0	0	1	-	0	69	1	0	70	-	0	48	0	0	48	-	120
<b>% Buses and Single-Unit Trucks</b>	0.5%	0%	0%	0%	0.3%	-	0%	6.7%	0%	0%	0.8%	-	0%	1.0%	2.7%	0%	1.0%	-	0%	0.7%	0%	0%	0.7%	-	0.8%
<b>Pedestrians</b>	-	-	-	-	-	4	-	-	-	-	-	1	-	-	-	-	-	1	-	-	-	-	-	-	0
<b>% Pedestrians</b>	-	-	-	-	-	100%	-	-	-	-	-	100%	-	-	-	-	-	100%	-	-	-	-	-	-	-
<b>Bicycles on Crosswalk</b>	-	-	-	-	-	0	-	-	-	-	-	0	-	-	-	-	-	0	-	-	-	-	-	-	0
<b>% Bicycles on Crosswalk</b>	-	-	-	-	-	0%	-	-	-	-	-	0%	-	-	-	-	-	0%	-	-	-	-	-	-	-

\*Pedestrians and Bicycles on Crosswalk. L: Left, R: Right, T: Thru, U: U-Turn

### 9. Belt Line Village Driveway at Preston Road - TMC

Wed May 12, 2021

AM Peak (7:30 AM - 8:30 AM)

All Classes (Lights, Articulated Trucks, Buses and Single-Unit Trucks, Pedestrians, Bicycles on Crosswalk)

All Movements

ID: 835148, Location: 32.95232, -96.803674



Provided by: C. J. Hensch & Associates Inc.

5215 Sycamore Ave.,  
Pasadena, TX, 77503, US

Leg Direction	Belt Line Village Driveway Eastbound							Belt Line Village Driveway Westbound							Preston Road Northbound							Preston Road Southbound							
Time	L	T	R	U	App	Ped*	L	T	R	U	App	Ped*	L	T	R	U	App	Ped*	L	T	R	U	App	Ped*	Int				
2021-05-12 7:30AM	4	0	3	0	7	1	0	1	0	0	1	0	3	351	1	0	355	0	1	443	7	1	452	0	815				
7:45AM	13	1	4	0	18	0	1	0	0	0	1	0	7	366	1	0	374	0	3	440	11	0	454	0	847				
8:00AM	6	0	7	0	13	0	0	1	0	0	1	0	5	433	0	0	438	0	1	499	5	0	505	0	957				
8:15AM	14	0	12	0	26	0	3	0	0	0	3	0	8	436	1	0	445	0	3	519	4	2	528	0	1002				
<b>Total</b>	37	1	26	0	64	1	4	2	0	0	6	0	23	1586	3	0	1612	0	8	1901	27	3	1939	0	3621				
<b>% Approach</b>	57.8%	1.6%	40.6%	0%	-	-	66.7%	33.3%	0%	0%	-	-	1.4%	98.4%	0.2%	0%	-	-	0.4%	98.0%	1.4%	0.2%	-	-	-				
<b>% Total</b>	1.0%	0%	0.7%	0%	1.8%	-	0.1%	0.1%	0%	0%	0.2%	-	0.6%	43.8%	0.1%	0%	44.5%	-	0.2%	52.5%	0.7%	0.1%	53.5%	-	-				
<b>PHF</b>	0.661	0.250	0.542	-	0.615	-	0.333	0.500	-	-	0.500	-	0.719	0.909	0.750	-	0.906	-	0.667	0.916	0.614	0.375	0.918	-	0.903				
<b>Lights</b>	37	1	26	0	64	-	4	2	0	0	6	-	23	1552	3	0	1578	-	8	1889	27	3	1927	-	3575				
<b>% Lights</b>	100%	100%	100%	0%	100%	-	100%	100%	0%	0%	100%	-	100%	97.9%	100%	0%	97.9%	-	100%	99.4%	100%	100%	99.4%	-	98.7%				
<b>Articulated Trucks</b>	0	0	0	0	0	-	0	0	0	0	0	-	0	4	0	0	4	-	0	5	0	0	5	-	9				
<b>% Articulated Trucks</b>	0%	0%	0%	0%	0%	-	0%	0%	0%	0%	0%	-	0%	0.3%	0%	0%	0.2%	-	0%	0.3%	0%	0%	0.3%	-	0.2%				
<b>Buses and Single-Unit Trucks</b>	0	0	0	0	0	-	0	0	0	0	0	-	0	30	0	0	30	-	0	7	0	0	7	-	37				
<b>% Buses and Single-Unit Trucks</b>	0%	0%	0%	0%	0%	-	0%	0%	0%	0%	0%	-	0%	1.9%	0%	0%	1.9%	-	0%	0.4%	0%	0%	0.4%	-	1.0%				
Pedestrians	-	-	-	-	-	1	-	-	-	-	-	0	-	-	-	-	-	0	-	-	-	-	-	0	-				
% Pedestrians	-	-	-	-	-	100%	-	-	-	-	-	-	-	-	-	-	-	-	-	-	-	-	-	-	-				
Bicycles on Crosswalk	-	-	-	-	-	0	-	-	-	-	-	0	-	-	-	-	-	0	-	-	-	-	-	0	-				
% Bicycles on Crosswalk	-	-	-	-	-	0%	-	-	-	-	-	-	-	-	-	-	-	-	-	-	-	-	-	-	-				

\*Pedestrians and Bicycles on Crosswalk. L: Left, R: Right, T: Thru, U: U-Turn

**9. Belt Line Village Driveway at Preston Road - TMC**

Wed May 12, 2021

PM Peak (4:45 PM - 5:45 PM) - Overall Peak Hour

All Classes (Lights, Articulated Trucks, Buses and Single-Unit Trucks, Pedestrians, Bicycles on Crosswalk)

All Movements

ID: 835148, Location: 32.95232, -96.803674



Provided by: C. J. Hensch & Associates Inc.  
5215 Sycamore Ave.,  
Pasadena, TX, 77503, US

Leg Direction	Belt Line Village Driveway Eastbound						Belt Line Village Driveway Westbound						Preston Road Northbound						Preston Road Southbound						Int
	L	T	R	U	App	Ped*	L	T	R	U	App	Ped*	L	T	R	U	App	Ped*	L	T	R	U	App	Ped*	
2021-05-12 4:45PM	20	1	18	0	<b>39</b>	0	5	0	2	0	<b>7</b>	0	17	491	5	0	<b>513</b>	0	12	411	8	1	<b>432</b>	0	<b>991</b>
5:00PM	21	1	12	0	<b>34</b>	0	5	2	6	0	<b>13</b>	0	21	532	5	0	<b>558</b>	0	10	460	4	1	<b>475</b>	0	<b>1080</b>
5:15PM	19	2	11	0	<b>32</b>	0	7	3	5	0	<b>15</b>	0	20	523	2	0	<b>545</b>	0	23	438	7	0	<b>468</b>	0	<b>1060</b>
5:30PM	17	1	11	0	<b>29</b>	0	7	1	5	0	<b>13</b>	0	7	574	0	1	<b>582</b>	0	11	444	6	6	<b>467</b>	0	<b>1091</b>
<b>Total</b>	<b>77</b>	<b>5</b>	<b>52</b>	<b>0</b>	<b>134</b>	<b>0</b>	<b>24</b>	<b>6</b>	<b>18</b>	<b>0</b>	<b>48</b>	<b>0</b>	<b>65</b>	<b>2120</b>	<b>12</b>	<b>1</b>	<b>2198</b>	<b>0</b>	<b>56</b>	<b>1753</b>	<b>25</b>	<b>8</b>	<b>1842</b>	<b>0</b>	<b>4222</b>
<b>% Approach</b>	57.5%	3.7%	38.8%	0%	-	-	50.0%	12.5%	37.5%	0%	-	-	3.0%	96.5%	0.5%	0%	-	-	3.0%	95.2%	1.4%	0.4%	-	-	-
<b>% Total</b>	1.8%	0.1%	1.2%	0%	<b>3.2%</b>	-	0.6%	0.1%	0.4%	0%	<b>1.1%</b>	-	1.5%	50.2%	0.3%	0%	<b>52.1%</b>	-	1.3%	41.5%	0.6%	0.2%	<b>43.6%</b>	-	-
<b>PHF</b>	0.917	0.625	0.722	-	<b>0.859</b>	-	0.857	0.500	0.750	-	<b>0.800</b>	-	0.774	0.923	0.600	0.250	<b>0.944</b>	-	0.609	0.953	0.781	0.333	<b>0.969</b>	-	0.967
<b>Lights</b>	77	5	52	0	<b>134</b>	-	24	5	18	0	<b>47</b>	-	65	2112	12	1	<b>2190</b>	-	56	1733	25	8	<b>1822</b>	-	4193
<b>% Lights</b>	100%	100%	100%	0%	<b>100%</b>	-	100%	83.3%	100%	0%	<b>97.9%</b>	-	100%	99.6%	100%	100%	<b>99.6%</b>	-	100%	98.9%	100%	100%	<b>98.9%</b>	-	99.3%
<b>Articulated Trucks</b>	0	0	0	0	<b>0</b>	-	0	0	0	0	<b>0</b>	-	0	1	0	0	<b>1</b>	-	0	2	0	0	<b>2</b>	-	3
<b>% Articulated Trucks</b>	0%	0%	0%	0%	<b>0%</b>	-	0%	0%	0%	0%	<b>0%</b>	-	0%	0%	0%	0%	<b>0%</b>	-	0%	0.1%	0%	0%	<b>0.1%</b>	-	0.1%
<b>Buses and Single-Unit Trucks</b>	0	0	0	0	<b>0</b>	-	0	1	0	0	<b>1</b>	-	0	7	0	0	<b>7</b>	-	0	18	0	0	<b>18</b>	-	26
<b>% Buses and Single-Unit Trucks</b>	0%	0%	0%	0%	<b>0%</b>	-	0%	16.7%	0%	0%	<b>2.1%</b>	-	0%	0.3%	0%	0%	<b>0.3%</b>	-	0%	1.0%	0%	0%	<b>1.0%</b>	-	0.6%
Pedestrians	-	-	-	-	-	0	-	-	-	-	-	0	-	-	-	-	-	0	-	-	-	-	-	-	0
% Pedestrians	-	-	-	-	-	-	-	-	-	-	-	-	-	-	-	-	-	-	-	-	-	-	-	-	-
Bicycles on Crosswalk	-	-	-	-	-	0	-	-	-	-	-	0	-	-	-	-	-	0	-	-	-	-	-	-	0
% Bicycles on Crosswalk	-	-	-	-	-	-	-	-	-	-	-	-	-	-	-	-	-	-	-	-	-	-	-	-	-

\*Pedestrians and Bicycles on Crosswalk. L: Left, R: Right, T: Thru, U: U-Turn

10. Median Opening at Preston Road - TMC

Wed May 12, 2021

Full Length (7 AM-9 AM, 4:30 PM-6:30 PM)

All Classes (Lights, Articulated Trucks, Buses and Single-Unit Trucks, Pedestrians, Bicycles on Crosswalk)

All Movements

ID: 835149, Location: 32.95135, -96.803551



Provided by: C. J. Hensch & Associates Inc.  
5215 Sycamore Ave.,  
Pasadena, TX, 77503, US

Leg Direction	Driveway Eastbound						Driveway Westbound						Preston Road Northbound						Preston Road Southbound						Int
	L	T	R	U	App	Ped*	L	T	R	U	App	Ped*	L	T	R	U	App	Ped*	L	T	R	U	App	Ped*	
2021-05-12 7:00AM	2	0	9	0	11	0	1	0	2	0	3	0	12	201	0	0	213	0	1	293	15	0	309	0	536
7:15AM	3	0	2	0	5	1	0	0	1	0	1	0	9	229	3	1	242	0	0	461	13	0	474	0	722
7:30AM	3	0	7	0	10	1	1	0	3	0	4	0	10	354	6	0	370	0	0	434	12	1	447	0	831
7:45AM	2	2	5	0	9	0	1	1	2	0	4	0	20	383	8	0	411	0	4	430	12	0	446	0	870
Hourly Total	10	2	23	0	35	2	3	1	8	0	12	0	51	1167	17	1	1236	0	5	1618	52	1	1676	0	2959
8:00AM	3	0	4	0	7	0	2	0	3	0	5	0	8	416	1	0	425	0	7	491	13	0	511	0	948
8:15AM	1	1	8	0	10	0	3	0	0	0	3	0	9	473	2	1	485	0	4	499	27	0	530	0	1028
8:30AM	6	1	4	0	11	0	0	0	2	0	2	0	11	334	0	0	345	0	1	423	10	0	434	0	792
8:45AM	0	1	10	0	11	1	3	0	0	0	3	0	18	362	4	0	384	0	1	364	11	0	376	0	774
Hourly Total	10	3	26	0	39	1	8	0	5	0	13	0	46	1585	7	1	1639	0	13	1777	61	0	1851	0	3542
4:30PM	2	0	9	0	11	0	4	0	12	0	16	0	25	507	10	1	543	0	3	367	13	1	384	1	954
4:45PM	1	2	9	0	12	0	5	0	12	0	17	0	21	504	8	3	536	1	3	391	20	0	414	0	979
Hourly Total	3	2	18	0	23	0	9	0	24	0	33	0	46	1011	18	4	1079	1	6	758	33	1	798	1	1933
5:00PM	3	1	16	0	20	0	2	1	10	0	13	0	22	553	7	1	583	0	9	422	20	2	453	0	1069
5:15PM	3	0	10	0	13	0	0	0	15	0	15	0	30	566	6	0	602	0	5	404	13	0	422	0	1052
5:30PM	4	2	24	0	30	0	2	1	15	0	18	0	19	529	12	0	560	0	6	446	14	4	470	0	1078
5:45PM	7	0	8	0	15	0	3	1	12	0	16	0	11	526	12	1	550	0	9	358	11	3	381	1	962
Hourly Total	17	3	58	0	78	0	7	3	52	0	62	0	82	2174	37	2	2295	0	29	1630	58	9	1726	1	4161
6:00PM	4	0	9	0	13	2	3	0	32	1	36	0	26	513	7	2	548	0	9	373	17	1	400	0	997
6:15PM	4	0	16	1	21	1	1	0	24	0	25	0	12	526	9	1	548	0	11	403	14	4	432	0	1026
Hourly Total	8	0	25	1	34	3	4	0	56	1	61	0	38	1039	16	3	1096	0	20	776	31	5	832	0	2023
<b>Total</b>	<b>48</b>	<b>10</b>	<b>150</b>	<b>1</b>	<b>209</b>	<b>6</b>	<b>31</b>	<b>4</b>	<b>145</b>	<b>1</b>	<b>181</b>	<b>0</b>	<b>263</b>	<b>6976</b>	<b>95</b>	<b>11</b>	<b>7345</b>	<b>1</b>	<b>73</b>	<b>6559</b>	<b>235</b>	<b>16</b>	<b>6883</b>	<b>2</b>	<b>14618</b>
<b>% Approach</b>	23.0%	4.8%	71.8%	0.5%	-	-	17.1%	2.2%	80.1%	0.6%	-	-	3.6%	95.0%	1.3%	0.1%	-	-	1.1%	95.3%	3.4%	0.2%	-	-	-
<b>% Total</b>	0.3%	0.1%	1.0%	0%	1.4%	-	0.2%	0%	1.0%	0%	1.2%	-	1.8%	47.7%	0.6%	0.1%	50.2%	-	0.5%	44.9%	1.6%	0.1%	47.1%	-	-
<b>Lights</b>	46	10	149	1	206	-	29	4	142	1	176	-	261	6904	95	11	7271	-	73	6496	234	16	6819	-	14472
<b>% Lights</b>	95.8%	100%	99.3%	100%	98.6%	-	93.5%	100%	97.9%	100%	97.2%	-	99.2%	99.0%	100%	100%	99.0%	-	100%	99.0%	99.6%	100%	99.1%	-	99.0%
<b>Articulated Trucks</b>	0	0	0	0	0	-	0	0	0	0	0	-	0	5	0	0	5	-	0	12	0	0	12	-	17
<b>% Articulated Trucks</b>	0%	0%	0%	0%	0%	-	0%	0%	0%	0%	0%	-	0%	0.1%	0%	0%	0.1%	-	0%	0.2%	0%	0%	0.2%	-	0.1%
<b>Buses and Single-Unit Trucks</b>	2	0	1	0	3	-	2	0	3	0	5	-	2	67	0	0	69	-	0	51	1	0	52	-	129
<b>% Buses and Single-Unit Trucks</b>	4.2%	0%	0.7%	0%	1.4%	-	6.5%	0%	2.1%	0%	2.8%	-	0.8%	1.0%	0%	0%	0.9%	-	0%	0.8%	0.4%	0%	0.8%	-	0.9%
<b>Pedestrians</b>	-	-	-	-	-	5	-	-	-	-	-	0	-	-	-	-	-	1	-	-	-	-	-	1	-
<b>% Pedestrians</b>	-	-	-	-	-	83.3%	-	-	-	-	-	-	-	-	-	-	-	100%	-	-	-	-	-	50.0%	-
<b>Bicycles on Crosswalk</b>	-	-	-	-	-	1	-	-	-	-	-	0	-	-	-	-	-	0	-	-	-	-	-	1	-
<b>% Bicycles on Crosswalk</b>	-	-	-	-	-	16.7%	-	-	-	-	-	-	-	-	-	-	-	0%	-	-	-	-	-	50.0%	-

\*Pedestrians and Bicycles on Crosswalk. L: Left, R: Right, T: Thru, U: U-Turn

10. Median Opening at Preston Road - TMC

Wed May 12, 2021

PM Peak (4:45 PM - 5:45 PM) - Overall Peak Hour

All Classes (Lights, Articulated Trucks, Buses and Single-Unit Trucks, Pedestrians, Bicycles on Crosswalk)

All Movements

ID: 835149, Location: 32.95135, -96.803551



Provided by: C. J. Hensch & Associates Inc.

5215 Sycamore Ave.,  
Pasadena, TX, 77503, US

Leg Direction	Driveway Eastbound						Driveway Westbound						Preston Road Northbound						Preston Road Southbound						Int
	L	T	R	U	App	Ped*	L	T	R	U	App	Ped*	L	T	R	U	App	Ped*	L	T	R	U	App	Ped*	
2021-05-12 4:45PM	1	2	9	0	12	0	5	0	12	0	17	0	21	504	8	3	536	1	3	391	20	0	414	0	979
5:00PM	3	1	16	0	20	0	2	1	10	0	13	0	22	553	7	1	583	0	9	422	20	2	453	0	1069
5:15PM	3	0	10	0	13	0	0	0	15	0	15	0	30	566	6	0	602	0	5	404	13	0	422	0	1052
5:30PM	4	2	24	0	30	0	2	1	15	0	18	0	19	529	12	0	560	0	6	446	14	4	470	0	1078
<b>Total</b>	11	5	59	0	75	0	9	2	52	0	63	0	92	2152	33	4	2281	1	23	1663	67	6	1759	0	4178
<b>% Approach</b>	14.7%	6.7%	78.7%	0%	-	-	14.3%	3.2%	82.5%	0%	-	-	4.0%	94.3%	1.4%	0.2%	-	-	1.3%	94.5%	3.8%	0.3%	-	-	-
<b>% Total</b>	0.3%	0.1%	1.4%	0%	1.8%	-	0.2%	0%	1.2%	0%	1.5%	-	2.2%	51.5%	0.8%	0.1%	54.6%	-	0.6%	39.8%	1.6%	0.1%	42.1%	-	-
<b>PHF</b>	0.688	0.625	0.615	-	0.625	-	0.450	0.500	0.867	-	0.875	-	0.767	0.951	0.688	0.333	0.947	-	0.639	0.932	0.838	0.375	0.936	-	0.969
<b>Lights</b>	10	5	59	0	74	-	9	2	52	0	63	-	91	2143	33	4	2271	-	23	1643	67	6	1739	-	4147
<b>% Lights</b>	90.9%	100%	100%	0%	98.7%	-	100%	100%	100%	0%	100%	-	98.9%	99.6%	100%	100%	99.6%	-	100%	98.8%	100%	100%	98.9%	-	99.3%
<b>Articulated Trucks</b>	0	0	0	0	0	-	0	0	0	0	0	-	0	1	0	0	1	-	0	2	0	0	2	-	3
<b>% Articulated Trucks</b>	0%	0%	0%	0%	0%	-	0%	0%	0%	0%	0%	-	0%	0%	0%	0%	0%	-	0%	0.1%	0%	0%	0.1%	-	0.1%
<b>Buses and Single-Unit Trucks</b>	1	0	0	0	1	-	0	0	0	0	0	-	1	8	0	0	9	-	0	18	0	0	18	-	28
<b>% Buses and Single-Unit Trucks</b>	9.1%	0%	0%	0%	1.3%	-	0%	0%	0%	0%	0%	-	1.1%	0.4%	0%	0%	0.4%	-	0%	1.1%	0%	0%	1.0%	-	0.7%
<b>Pedestrians</b>	-	-	-	-	-	0	-	-	-	-	-	0	-	-	-	-	-	1	-	-	-	-	-	0	-
<b>% Pedestrians</b>	-	-	-	-	-	-	-	-	-	-	-	-	-	-	-	-	-	100%	-	-	-	-	-	-	-
<b>Bicycles on Crosswalk</b>	-	-	-	-	-	0	-	-	-	-	-	0	-	-	-	-	-	0	-	-	-	-	-	0	-
<b>% Bicycles on Crosswalk</b>	-	-	-	-	-	-	-	-	-	-	-	-	-	-	-	-	-	0%	-	-	-	-	-	-	-

\*Pedestrians and Bicycles on Crosswalk. L: Left, R: Right, T: Thru, U: U-Turn

11. Alexis Drive at Preston Road - TMC

Wed May 12, 2021

Full Length (7 AM-9 AM, 4:30 PM-6:30 PM)

All Classes (Lights, Articulated Trucks, Buses and Single-Unit Trucks, Pedestrians, Bicycles on Crosswalk)

All Movements

ID: 835150, Location: 32.949842, -96.803548



Provided by: C. J. Hensch & Associates Inc.  
5215 Sycamore Ave.,  
Pasadena, TX, 77503, US

Leg Direction	Alexis Drive Eastbound						Alexis Drive Westbound						Preston Road Northbound						Preston Road Southbound						Int
	L	T	R	U	App	Ped*	L	T	R	U	App	Ped*	L	T	R	U	App	Ped*	L	T	R	U	App	Ped*	
2021-05-12 7:00AM	3	1	4	0	8	0	22	3	3	0	28	0	8	208	12	1	229	0	14	273	4	0	291	0	556
7:15AM	2	2	7	0	11	0	21	5	1	0	27	0	4	237	12	0	253	0	11	444	4	0	459	0	750
7:30AM	2	3	6	0	11	0	25	1	2	0	28	0	5	362	15	2	384	0	18	386	4	0	408	0	831
7:45AM	7	0	9	0	16	1	35	6	9	0	50	0	5	406	24	0	435	1	14	400	4	0	418	0	919
Hourly Total	14	6	26	0	46	1	103	15	15	0	133	0	22	1213	63	3	1301	1	57	1503	16	0	1576	0	3056
8:00AM	3	1	5	0	9	0	32	3	9	0	44	0	4	431	18	1	454	0	23	478	8	1	510	0	1017
8:15AM	4	3	2	0	9	1	30	4	7	0	41	0	6	469	21	2	498	0	12	491	3	0	506	0	1054
8:30AM	0	1	10	0	11	0	26	7	8	0	41	0	4	353	22	0	379	0	22	422	6	0	450	0	881
8:45AM	3	1	2	0	6	0	31	4	7	0	42	0	8	371	17	1	397	0	15	360	8	0	383	0	828
Hourly Total	10	6	19	0	35	1	119	18	31	0	168	0	22	1624	78	4	1728	0	72	1751	25	1	1849	0	3780
4:30PM	18	10	16	0	44	2	64	7	15	0	86	0	6	506	57	3	572	0	27	337	4	1	369	0	1071
4:45PM	14	7	13	0	34	0	39	2	23	0	64	0	8	491	49	1	549	0	28	383	2	1	414	0	1061
Hourly Total	32	17	29	0	78	2	103	9	38	0	150	0	14	997	106	4	1121	0	55	720	6	2	783	0	2132
5:00PM	21	7	20	0	48	0	38	3	18	0	59	3	7	554	59	1	621	3	32	395	3	0	430	0	1158
5:15PM	12	8	14	0	34	0	60	8	15	0	83	0	7	595	69	1	672	0	27	391	5	0	423	0	1212
5:30PM	14	5	15	0	34	0	48	5	20	0	73	0	16	508	41	1	566	0	33	426	6	0	465	0	1138
5:45PM	17	3	13	0	33	0	62	7	12	0	81	0	12	528	61	4	605	0	21	337	8	0	366	0	1085
Hourly Total	64	23	62	0	149	0	208	23	65	0	296	3	42	2185	230	7	2464	3	113	1549	22	0	1684	0	4593
6:00PM	10	2	16	0	28	3	51	9	24	0	84	0	15	533	54	0	602	0	27	356	2	1	386	0	1100
6:15PM	8	5	7	0	20	1	48	2	14	0	64	0	16	501	41	1	559	0	20	399	4	2	425	0	1068
Hourly Total	18	7	23	0	48	4	99	11	38	0	148	0	31	1034	95	1	1161	0	47	755	6	3	811	0	2168
<b>Total</b>	138	59	159	0	356	8	632	76	187	0	895	3	131	7053	572	19	7775	4	344	6278	75	6	6703	0	15729
<b>% Approach</b>	38.8%	16.6%	44.7%	0%	-	-	70.6%	8.5%	20.9%	0%	-	-	1.7%	90.7%	7.4%	0.2%	-	-	5.1%	93.7%	1.1%	0.1%	-	-	-
<b>% Total</b>	0.9%	0.4%	1.0%	0%	2.3%	-	4.0%	0.5%	1.2%	0%	5.7%	-	0.8%	44.8%	3.6%	0.1%	49.4%	-	2.2%	39.9%	0.5%	0%	42.6%	-	-
<b>Lights</b>	135	57	159	0	351	-	628	76	184	0	888	-	131	6976	569	19	7695	-	342	6226	74	6	6648	-	15582
<b>% Lights</b>	97.8%	96.6%	100%	0%	98.6%	-	99.4%	100%	98.4%	0%	99.2%	-	100%	98.9%	99.5%	100%	99.0%	-	99.4%	99.2%	98.7%	100%	99.2%	-	99.1%
<b>Articulated Trucks</b>	0	0	0	0	0	-	0	0	0	0	0	-	0	6	1	0	7	-	1	15	0	0	16	-	23
<b>% Articulated Trucks</b>	0%	0%	0%	0%	0%	-	0%	0%	0%	0%	0%	-	0%	0.1%	0.2%	0%	0.1%	-	0.3%	0.2%	0%	0%	0.2%	-	0.1%
<b>Buses and Single-Unit Trucks</b>	3	2	0	0	5	-	4	0	3	0	7	-	0	71	2	0	73	-	1	37	1	0	39	-	124
<b>% Buses and Single-Unit Trucks</b>	2.2%	3.4%	0%	0%	1.4%	-	0.6%	0%	1.6%	0%	0.8%	-	0%	1.0%	0.3%	0%	0.9%	-	0.3%	0.6%	1.3%	0%	0.6%	-	0.8%
<b>Pedestrians</b>	-	-	-	-	-	6	-	-	-	-	3	-	-	-	-	-	4	-	-	-	-	-	-	0	-
<b>% Pedestrians</b>	-	-	-	-	-	75.0%	-	-	-	-	100%	-	-	-	-	-	100%	-	-	-	-	-	-	-	-
<b>Bicycles on Crosswalk</b>	-	-	-	-	-	2	-	-	-	-	0	-	-	-	-	-	0	-	-	-	-	-	-	0	-
<b>% Bicycles on Crosswalk</b>	-	-	-	-	-	25.0%	-	-	-	-	0%	-	-	-	-	-	0%	-	-	-	-	-	-	-	-

\*Pedestrians and Bicycles on Crosswalk. L: Left, R: Right, T: Thru, U: U-Turn

11. Alexis Drive at Preston Road - TMC

Wed May 12, 2021

AM Peak (7:45 AM - 8:45 AM)

All Classes (Lights, Articulated Trucks, Buses and Single-Unit Trucks, Pedestrians, Bicycles on Crosswalk)

All Movements

ID: 835150, Location: 32.949842, -96.803548



Provided by: C. J. Hensch & Associates Inc.  
5215 Sycamore Ave.,  
Pasadena, TX, 77503, US

Leg Direction	Alexis Drive Eastbound						Alexis Drive Westbound						Preston Road Northbound						Preston Road Southbound						
Time	L	T	R	U	App	Ped*	L	T	R	U	App	Ped*	L	T	R	U	App	Ped*	L	T	R	U	App	Ped*	Int
2021-05-12 7:45AM	7	0	9	0	16	1	35	6	9	0	50	0	5	406	24	0	435	1	14	400	4	0	418	0	919
8:00AM	3	1	5	0	9	0	32	3	9	0	44	0	4	431	18	1	454	0	23	478	8	1	510	0	1017
8:15AM	4	3	2	0	9	1	30	4	7	0	41	0	6	469	21	2	498	0	12	491	3	0	506	0	1054
8:30AM	0	1	10	0	11	0	26	7	8	0	41	0	4	353	22	0	379	0	22	422	6	0	450	0	881
<b>Total</b>	14	5	26	0	45	2	123	20	33	0	176	0	19	1659	85	3	1766	1	71	1791	21	1	1884	0	3871
<b>% Approach</b>	31.1%	11.1%	57.8%	0%	-	-	69.9%	11.4%	18.8%	0%	-	-	1.1%	93.9%	4.8%	0.2%	-	-	3.8%	95.1%	1.1%	0.1%	-	-	-
<b>% Total</b>	0.4%	0.1%	0.7%	0%	1.2%	-	3.2%	0.5%	0.9%	0%	4.5%	-	0.5%	42.9%	2.2%	0.1%	45.6%	-	1.8%	46.3%	0.5%	0%	48.7%	-	-
<b>PHF</b>	0.500	0.417	0.650	-	0.703	-	0.879	0.714	0.917	-	0.880	-	0.792	0.884	0.885	0.375	0.887	-	0.772	0.912	0.656	0.250	0.924	-	0.918
<b>Lights</b>	11	4	26	0	41	-	122	20	32	0	174	-	19	1629	85	3	1736	-	71	1779	21	1	1872	-	3823
<b>% Lights</b>	78.6%	80.0%	100%	0%	91.1%	-	99.2%	100%	97.0%	0%	98.9%	-	100%	98.2%	100%	100%	98.3%	-	100%	99.3%	100%	100%	99.4%	-	98.8%
<b>Articulated Trucks</b>	0	0	0	0	0	-	0	0	0	0	0	-	0	2	0	0	2	-	0	3	0	0	3	-	5
<b>% Articulated Trucks</b>	0%	0%	0%	0%	0%	-	0%	0%	0%	0%	0%	-	0%	0.1%	0%	0%	0.1%	-	0%	0.2%	0%	0%	0.2%	-	0.1%
<b>Buses and Single-Unit Trucks</b>	3	1	0	0	4	-	1	0	1	0	2	-	0	28	0	0	28	-	0	9	0	0	9	-	43
<b>% Buses and Single-Unit Trucks</b>	21.4%	20.0%	0%	0%	8.9%	-	0.8%	0%	3.0%	0%	1.1%	-	0%	1.7%	0%	0%	1.6%	-	0%	0.5%	0%	0%	0.5%	-	1.1%
<b>Pedestrians</b>	-	-	-	-	-	2	-	-	-	-	-	0	-	-	-	-	-	1	-	-	-	-	-	0	
<b>% Pedestrians</b>	-	-	-	-	-	100%	-	-	-	-	-	-	-	-	-	-	-	100%	-	-	-	-	-	-	
<b>Bicycles on Crosswalk</b>	-	-	-	-	-	0	-	-	-	-	-	0	-	-	-	-	-	0	-	-	-	-	-	0	
<b>% Bicycles on Crosswalk</b>	-	-	-	-	-	0%	-	-	-	-	-	-	-	-	-	-	-	0%	-	-	-	-	-	-	

\*Pedestrians and Bicycles on Crosswalk. L: Left, R: Right, T: Thru, U: U-Turn

11. Alexis Drive at Preston Road - TMC

Wed May 12, 2021

PM Peak (5 PM - 6 PM) - Overall Peak Hour

All Classes (Lights, Articulated Trucks, Buses and Single-Unit Trucks, Pedestrians, Bicycles on Crosswalk)

All Movements

ID: 835150, Location: 32.949842, -96.803548



Provided by: C. J. Hensch & Associates Inc.

5215 Sycamore Ave., Pasadena, TX, 77503, US

Leg Direction	Alexis Drive Eastbound						Alexis Drive Westbound						Preston Road Northbound						Preston Road Southbound						Int
	L	T	R	U	App	Ped*	L	T	R	U	App	Ped*	L	T	R	U	App	Ped*	L	T	R	U	App	Ped*	
2021-05-12 5:00PM	21	7	20	0	48	0	38	3	18	0	59	3	7	554	59	1	621	3	32	395	3	0	430	0	1158
5:15PM	12	8	14	0	34	0	60	8	15	0	83	0	7	595	69	1	672	0	27	391	5	0	423	0	1212
5:30PM	14	5	15	0	34	0	48	5	20	0	73	0	16	508	41	1	566	0	33	426	6	0	465	0	1138
5:45PM	17	3	13	0	33	0	62	7	12	0	81	0	12	528	61	4	605	0	21	337	8	0	366	0	1085
<b>Total</b>	64	23	62	0	149	0	208	23	65	0	296	3	42	2185	230	7	2464	3	113	1549	22	0	1684	0	4593
<b>% Approach</b>	43.0%	15.4%	41.6%	0%	-	-	70.3%	7.8%	22.0%	0%	-	-	1.7%	88.7%	9.3%	0.3%	-	-	6.7%	92.0%	1.3%	0%	-	-	-
<b>% Total</b>	1.4%	0.5%	1.3%	0%	3.2%	-	4.5%	0.5%	1.4%	0%	6.4%	-	0.9%	47.6%	5.0%	0.2%	53.6%	-	2.5%	33.7%	0.5%	0%	36.7%	-	-
<b>PHF</b>	0.762	0.719	0.775	-	0.776	-	0.839	0.719	0.813	-	0.892	-	0.656	0.918	0.833	0.438	0.917	-	0.856	0.909	0.688	-	0.905	-	0.947
<b>Lights</b>	64	23	62	0	149	-	207	23	65	0	295	-	42	2176	228	7	2453	-	113	1534	22	0	1669	-	4566
<b>% Lights</b>	100%	100%	100%	0%	100%	-	99.5%	100%	100%	0%	99.7%	-	100%	99.6%	99.1%	100%	99.6%	-	100%	99.0%	100%	0%	99.1%	-	99.4%
<b>Articulated Trucks</b>	0	0	0	0	0	-	0	0	0	0	0	-	0	0	1	0	1	-	0	5	0	0	5	-	6
<b>% Articulated Trucks</b>	0%	0%	0%	0%	0%	-	0%	0%	0%	0%	0%	-	0%	0%	0.4%	0%	0%	-	0%	0.3%	0%	0%	0.3%	-	0.1%
<b>Buses and Single-Unit Trucks</b>	0	0	0	0	0	-	1	0	0	0	1	-	0	9	1	0	10	-	0	10	0	0	10	-	21
<b>% Buses and Single-Unit Trucks</b>	0%	0%	0%	0%	0%	-	0.5%	0%	0%	0%	0.3%	-	0%	0.4%	0.4%	0%	0.4%	-	0%	0.6%	0%	0%	0.6%	-	0.5%
<b>Pedestrians</b>	-	-	-	-	-	0	-	-	-	-	-	3	-	-	-	-	-	3	-	-	-	-	-	0	-
<b>% Pedestrians</b>	-	-	-	-	-	-	-	-	-	-	-	100%	-	-	-	-	-	100%	-	-	-	-	-	-	-
<b>Bicycles on Crosswalk</b>	-	-	-	-	-	0	-	-	-	-	-	0	-	-	-	-	-	0	-	-	-	-	-	0	-
<b>% Bicycles on Crosswalk</b>	-	-	-	-	-	-	-	-	-	-	-	0%	-	-	-	-	-	0%	-	-	-	-	-	-	-

\*Pedestrians and Bicycles on Crosswalk. L: Left, R: Right, T: Thru, U: U-Turn



12. Spring Valley Road at Preston Road - TMC

Wed May 12, 2021

Full Length (7 AM-9 AM, 4:30 PM-6:30 PM)

All Classes (Lights, Articulated Trucks, Buses and Single-Unit Trucks, Pedestrians, Bicycles on Crosswalk)

All Movements

ID: 835151, Location: 32.938687, -96.803659



Provided by: C. J. Hensch & Associates Inc.  
5215 Sycamore Ave.,  
Pasadena, TX, 77503, US

Leg Direction	Spring Valley Road Eastbound						Spring Valley Road Westbound						Preston Road Northbound						Preston Road Southbound						
Time	L	T	R	U	App	Ped*	L	T	R	U	App	Ped*	L	T	R	U	App	Ped*	L	T	R	U	App	Ped*	Int
2021-05-12 7:00AM	20	58	68	0	146	0	7	75	11	0	93	0	15	166	6	0	187	1	13	340	24	0	377	0	803
7:15AM	24	60	64	0	148	3	11	107	13	0	131	0	22	234	8	0	264	0	20	494	35	0	549	0	1092
7:30AM	36	91	72	0	199	0	21	194	33	0	248	0	20	267	14	0	301	0	44	394	42	0	480	0	1228
7:45AM	38	89	52	0	179	0	23	160	32	0	215	0	18	359	18	0	395	0	29	490	47	0	566	0	1355
Hourly Total	118	298	256	0	672	3	62	536	89	0	687	0	75	1026	46	0	1147	1	106	1718	148	0	1972	0	4478
8:00AM	27	83	60	0	170	0	26	164	35	0	225	0	28	419	25	0	472	0	24	459	33	0	516	0	1383
8:15AM	30	70	54	0	154	0	15	152	32	0	199	0	39	368	12	0	419	0	33	493	35	1	562	0	1334
8:30AM	23	49	40	0	112	0	19	132	34	0	185	0	22	331	12	0	365	0	17	448	35	0	500	0	1162
8:45AM	36	45	57	0	138	0	32	124	31	0	187	0	17	343	15	0	375	0	19	339	36	0	394	0	1094
Hourly Total	116	247	211	0	574	0	92	572	132	0	796	0	106	1461	64	0	1631	0	93	1739	139	1	1972	0	4973
4:30PM	65	177	62	0	304	1	24	85	35	0	144	0	36	485	41	0	562	0	39	382	36	0	457	0	1467
4:45PM	45	142	54	0	241	0	38	114	37	0	189	0	49	519	47	0	615	0	43	352	34	1	430	0	1475
Hourly Total	110	319	116	0	545	1	62	199	72	0	333	0	85	1004	88	0	1177	0	82	734	70	1	887	0	2942
5:00PM	69	210	62	0	341	1	36	118	40	0	194	0	33	481	32	0	546	0	29	392	31	1	453	0	1534
5:15PM	84	201	50	0	335	0	18	93	39	0	150	0	47	605	45	0	697	1	51	392	40	1	484	0	1666
5:30PM	66	180	56	0	302	0	26	126	25	0	177	0	65	484	50	0	599	0	36	355	53	0	444	0	1522
5:45PM	60	169	49	0	278	2	20	130	43	0	193	0	39	512	64	1	616	0	31	342	50	4	427	0	1514
Hourly Total	279	760	217	0	1256	3	100	467	147	0	714	0	184	2082	191	1	2458	1	147	1481	174	6	1808	0	6236
6:00PM	68	124	42	0	234	3	15	135	50	0	200	0	50	540	63	2	655	0	30	337	44	1	412	0	1501
6:15PM	60	137	43	0	240	1	21	124	46	1	192	0	54	425	69	0	548	0	42	323	38	1	404	0	1384
Hourly Total	128	261	85	0	474	4	36	259	96	1	392	0	104	965	132	2	1203	0	72	660	82	2	816	0	2885
<b>Total</b>	751	1885	885	0	3521	11	352	2033	536	1	2922	0	554	6538	521	3	7616	2	500	6332	613	10	7455	0	21514
<b>% Approach</b>	21.3%	53.5%	25.1%	0%	-	-	12.0%	69.6%	18.3%	0%	-	-	7.3%	85.8%	6.8%	0%	-	-	6.7%	84.9%	8.2%	0.1%	-	-	-
<b>% Total</b>	3.5%	8.8%	4.1%	0%	16.4%	-	1.6%	9.4%	2.5%	0%	13.6%	-	2.6%	30.4%	2.4%	0%	35.4%	-	2.3%	29.4%	2.8%	0%	34.7%	-	-
<b>Lights</b>	749	1868	870	0	3487	-	350	2015	535	1	2901	-	547	6462	513	3	7525	-	499	6259	609	10	7377	-	21290
<b>% Lights</b>	99.7%	99.1%	98.3%	0%	99.0%	-	99.4%	99.1%	99.8%	100%	99.3%	-	98.7%	98.8%	98.5%	100%	98.8%	-	99.8%	98.8%	99.3%	100%	99.0%	-	99.0%
<b>Articulated Trucks</b>	0	1	0	0	1	-	0	0	0	0	0	-	0	7	3	0	10	-	0	12	0	0	12	-	23
<b>% Articulated Trucks</b>	0%	0.1%	0%	0%	0%	-	0%	0%	0%	0%	0%	-	0%	0.1%	0.6%	0%	0.1%	-	0%	0.2%	0%	0%	0.2%	-	0.1%
<b>Buses and Single-Unit Trucks</b>	2	16	15	0	33	-	2	18	1	0	21	-	7	69	5	0	81	-	1	61	4	0	66	-	201
<b>% Buses and Single-Unit Trucks</b>	0.3%	0.8%	1.7%	0%	0.9%	-	0.6%	0.9%	0.2%	0%	0.7%	-	1.3%	1.1%	1.0%	0%	1.1%	-	0.2%	1.0%	0.7%	0%	0.9%	-	0.9%
<b>Pedestrians</b>	-	-	-	-	-	9	-	-	-	-	-	0	-	-	-	-	-	2	-	-	-	-	-	0	-
<b>% Pedestrians</b>	-	-	-	-	-	81.8%	-	-	-	-	-	-	-	-	-	-	-	100%	-	-	-	-	-	-	-
<b>Bicycles on Crosswalk</b>	-	-	-	-	-	2	-	-	-	-	-	0	-	-	-	-	-	0	-	-	-	-	-	0	-
<b>% Bicycles on Crosswalk</b>	-	-	-	-	-	18.2%	-	-	-	-	-	-	-	-	-	-	-	0%	-	-	-	-	-	-	-

\*Pedestrians and Bicycles on Crosswalk. L: Left, R: Right, T: Thru, U: U-Turn

## 12. Spring Valley Road at Preston Road - TMC

Wed May 12, 2021

AM Peak (7:30 AM - 8:30 AM)

All Classes (Lights, Articulated Trucks, Buses and Single-Unit Trucks, Pedestrians, Bicycles on Crosswalk)

All Movements

ID: 835151, Location: 32.938687, -96.803659



Provided by: C. J. Hensch & Associates Inc.

5215 Sycamore Ave.,  
Pasadena, TX, 77503, US

Leg Direction	Spring Valley Road Eastbound					Spring Valley Road Westbound					Preston Road Northbound					Preston Road Southbound									
Time	L	T	R	U	App Ped*	L	T	R	U	App Ped*	L	T	R	U	App Ped*	L	T	R	U	App Ped*	Int				
2021-05-12 7:30AM	36	91	72	0	199	0	21	194	33	0	248	0	20	267	14	0	301	0	44	394	42	0	480	0	1228
7:45AM	38	89	52	0	179	0	23	160	32	0	215	0	18	359	18	0	395	0	29	490	47	0	566	0	1355
8:00AM	27	83	60	0	170	0	26	164	35	0	225	0	28	419	25	0	472	0	24	459	33	0	516	0	1383
8:15AM	30	70	54	0	154	0	15	152	32	0	199	0	39	368	12	0	419	0	33	493	35	1	562	0	1334
<b>Total</b>	131	333	238	0	702	0	85	670	132	0	887	0	105	1413	69	0	1587	0	130	1836	157	1	2124	0	5300
<b>% Approach</b>	18.7%	47.4%	33.9%	0%	-	-	9.6%	75.5%	14.9%	0%	-	-	6.6%	89.0%	4.3%	0%	-	-	6.1%	86.4%	7.4%	0%	-	-	-
<b>% Total</b>	2.5%	6.3%	4.5%	0%	13.2%	-	1.6%	12.6%	2.5%	0%	16.7%	-	2.0%	26.7%	1.3%	0%	29.9%	-	2.5%	34.6%	3.0%	0%	40.1%	-	-
<b>PHF</b>	0.862	0.915	0.826	-	0.882	-	0.817	0.863	0.943	-	0.894	-	0.673	0.843	0.690	-	0.841	-	0.739	0.931	0.835	0.250	0.938	-	0.958
<b>Lights</b>	131	327	233	0	691	-	84	665	131	0	880	-	104	1383	65	0	1552	-	130	1821	156	1	2108	-	5231
<b>% Lights</b>	100%	98.2%	97.9%	0%	98.4%	-	98.8%	99.3%	99.2%	0%	99.2%	-	99.0%	97.9%	94.2%	0%	97.8%	-	100%	99.2%	99.4%	100%	99.2%	-	98.7%
<b>Articulated Trucks</b>	0	1	0	0	1	-	0	0	0	0	0	-	0	1	1	0	2	-	0	5	0	0	5	-	8
<b>% Articulated Trucks</b>	0%	0.3%	0%	0%	0.1%	-	0%	0%	0%	0%	0%	-	0%	0.1%	1.4%	0%	0.1%	-	0%	0.3%	0%	0%	0.2%	-	0.2%
<b>Buses and Single-Unit Trucks</b>	0	5	5	0	10	-	1	5	1	0	7	-	1	29	3	0	33	-	0	10	1	0	11	-	61
<b>% Buses and Single-Unit Trucks</b>	0%	1.5%	2.1%	0%	1.4%	-	1.2%	0.7%	0.8%	0%	0.8%	-	1.0%	2.1%	4.3%	0%	2.1%	-	0%	0.5%	0.6%	0%	0.5%	-	1.2%
<b>Pedestrians</b>	-	-	-	-	0	-	-	-	-	-	0	-	-	-	-	-	0	-	-	-	-	-	-	0	-
<b>% Pedestrians</b>	-	-	-	-	-	-	-	-	-	-	-	-	-	-	-	-	-	-	-	-	-	-	-	-	-
<b>Bicycles on Crosswalk</b>	-	-	-	-	0	-	-	-	-	-	0	-	-	-	-	-	0	-	-	-	-	-	-	0	-
<b>% Bicycles on Crosswalk</b>	-	-	-	-	-	-	-	-	-	-	-	-	-	-	-	-	-	-	-	-	-	-	-	-	-

\*Pedestrians and Bicycles on Crosswalk. L: Left, R: Right, T: Thru, U: U-Turn

12. Spring Valley Road at Preston Road - TMC

Wed May 12, 2021

PM Peak (5 PM - 6 PM) - Overall Peak Hour

All Classes (Lights, Articulated Trucks, Buses and Single-Unit Trucks, Pedestrians, Bicycles on Crosswalk)

All Movements

ID: 835151, Location: 32.938687, -96.803659



Provided by: C. J. Hensch & Associates Inc.  
5215 Sycamore Ave.,  
Pasadena, TX, 77503, US

Leg Direction	Spring Valley Road Eastbound						Spring Valley Road Westbound						Preston Road Northbound						Preston Road Southbound						Int
Time	L	T	R	U	App	Ped*	L	T	R	U	App	Ped*	L	T	R	U	App	Ped*	L	T	R	U	App	Ped*	
2021-05-12 5:00PM	69	210	62	0	341	1	36	118	40	0	194	0	33	481	32	0	546	0	29	392	31	1	453	0	1534
5:15PM	84	201	50	0	335	0	18	93	39	0	150	0	47	605	45	0	697	1	51	392	40	1	484	0	1666
5:30PM	66	180	56	0	302	0	26	126	25	0	177	0	65	484	50	0	599	0	36	355	53	0	444	0	1522
5:45PM	60	169	49	0	278	2	20	130	43	0	193	0	39	512	64	1	616	0	31	342	50	4	427	0	1514
<b>Total</b>	279	760	217	0	1256	3	100	467	147	0	714	0	184	2082	191	1	2458	1	147	1481	174	6	1808	0	6236
<b>% Approach</b>	22.2%	60.5%	17.3%	0%	-	-	14.0%	65.4%	20.6%	0%	-	-	7.5%	84.7%	7.8%	0%	-	-	8.1%	81.9%	9.6%	0.3%	-	-	-
<b>% Total</b>	4.5%	12.2%	3.5%	0%	20.1%	-	1.6%	7.5%	2.4%	0%	11.4%	-	3.0%	33.4%	3.1%	0%	39.4%	-	2.4%	23.7%	2.8%	0.1%	29.0%	-	-
<b>PHF</b>	0.830	0.905	0.875	-	0.921	-	0.694	0.898	0.855	-	0.920	-	0.708	0.860	0.746	0.250	0.882	-	0.721	0.945	0.821	0.375	0.934	-	0.936
<b>Lights</b>	279	755	214	0	1248	-	99	463	147	0	709	-	182	2073	191	1	2447	-	147	1457	173	6	1783	-	6187
<b>% Lights</b>	100%	99.3%	98.6%	0%	99.4%	-	99.0%	99.1%	100%	0%	99.3%	-	98.9%	99.6%	100%	100%	99.6%	-	100%	98.4%	99.4%	100%	98.6%	-	99.2%
<b>Articulated Trucks</b>	0	0	0	0	0	-	0	0	0	0	0	-	0	1	0	0	1	-	0	3	0	0	3	-	4
<b>% Articulated Trucks</b>	0%	0%	0%	0%	0%	-	0%	0%	0%	0%	0%	-	0%	0%	0%	0%	0%	-	0%	0.2%	0%	0%	0.2%	-	0.1%
<b>Buses and Single-Unit Trucks</b>	0	5	3	0	8	-	1	4	0	0	5	-	2	8	0	0	10	-	0	21	1	0	22	-	45
<b>% Buses and Single-Unit Trucks</b>	0%	0.7%	1.4%	0%	0.6%	-	1.0%	0.9%	0%	0%	0.7%	-	1.1%	0.4%	0%	0%	0.4%	-	0%	1.4%	0.6%	0%	1.2%	-	0.7%
<b>Pedestrians</b>	-	-	-	-	-	1	-	-	-	-	-	0	-	-	-	-	-	1	-	-	-	-	-	0	-
<b>% Pedestrians</b>	-	-	-	-	-	33.3%	-	-	-	-	-	-	-	-	-	-	-	100%	-	-	-	-	-	-	-
<b>Bicycles on Crosswalk</b>	-	-	-	-	-	2	-	-	-	-	-	0	-	-	-	-	-	0	-	-	-	-	-	0	-
<b>% Bicycles on Crosswalk</b>	-	-	-	-	-	66.7%	-	-	-	-	-	-	-	-	-	-	-	0%	-	-	-	-	-	-	-

\*Pedestrians and Bicycles on Crosswalk. L: Left, R: Right, T: Thru, U: U-Turn

13. Belt Line Road at Preston Road - TMC

Wed May 12, 2021

Full Length (12 AM-12 AM (+1))

All Classes (Lights, Articulated Trucks, Buses and Single-Unit Trucks, Pedestrians, Bicycles on Crosswalk)

All Movements

ID: 835154, Location: 32.953954, -96.804067



Provided by: C. J. Hensch & Associates Inc.  
5215 Sycamore Ave.,  
Pasadena, TX, 77503, US

Leg Direction	Belt Line Road Eastbound						Belt Line Road Westbound						Preston Road Northbound						Preston Road Southbound						Int
	L	T	R	U	App	Ped*	L	T	R	U	App	Ped*	L	T	R	U	App	Ped*	L	T	R	U	App	Ped*	
2021-05-12 12:00AM	6	27	16	0	49	1	1	11	2	0	14	0	15	49	2	1	67	0	7	51	5	0	63	0	193
12:15AM	5	21	11	0	37	0	0	4	0	0	4	0	8	36	1	0	45	2	3	31	8	0	42	0	128
12:30AM	4	18	8	1	31	0	0	6	1	0	7	0	6	38	1	0	45	0	1	23	2	0	26	0	109
12:45AM	6	10	6	0	22	0	0	12	3	0	15	0	8	29	1	0	38	0	2	16	1	0	19	0	94
<b>Hourly Total</b>	<b>21</b>	<b>76</b>	<b>41</b>	<b>1</b>	<b>139</b>	<b>1</b>	<b>1</b>	<b>33</b>	<b>6</b>	<b>0</b>	<b>40</b>	<b>0</b>	<b>37</b>	<b>152</b>	<b>5</b>	<b>1</b>	<b>195</b>	<b>2</b>	<b>13</b>	<b>121</b>	<b>16</b>	<b>0</b>	<b>150</b>	<b>0</b>	<b>524</b>
1:00AM	2	8	3	0	13	0	0	7	0	0	7	0	10	17	0	1	28	0	1	23	0	0	24	0	72
1:15AM	1	13	6	0	20	0	0	4	1	0	5	0	7	18	4	1	30	0	3	19	0	0	22	0	77
1:30AM	1	4	2	0	7	0	2	9	2	0	13	0	3	20	1	2	26	0	3	19	3	0	25	0	71
1:45AM	2	3	3	0	8	0	0	5	3	0	8	0	5	20	0	2	27	0	1	9	3	0	13	0	56
<b>Hourly Total</b>	<b>6</b>	<b>28</b>	<b>14</b>	<b>0</b>	<b>48</b>	<b>0</b>	<b>2</b>	<b>25</b>	<b>6</b>	<b>0</b>	<b>33</b>	<b>0</b>	<b>25</b>	<b>75</b>	<b>5</b>	<b>6</b>	<b>111</b>	<b>0</b>	<b>8</b>	<b>70</b>	<b>6</b>	<b>0</b>	<b>84</b>	<b>0</b>	<b>276</b>
2:00AM	2	7	6	1	16	0	1	1	1	0	3	0	9	15	1	1	26	0	1	19	3	0	23	0	68
2:15AM	3	6	6	1	16	0	0	4	0	0	4	0	0	29	1	1	31	0	1	11	2	0	14	0	65
2:30AM	0	10	2	0	12	0	0	4	0	0	4	0	2	15	1	0	18	0	1	10	1	0	12	0	46
2:45AM	1	5	4	0	10	0	0	5	0	0	5	0	1	9	0	0	10	0	1	11	2	0	14	0	39
<b>Hourly Total</b>	<b>6</b>	<b>28</b>	<b>18</b>	<b>2</b>	<b>54</b>	<b>0</b>	<b>1</b>	<b>14</b>	<b>1</b>	<b>0</b>	<b>16</b>	<b>0</b>	<b>12</b>	<b>68</b>	<b>3</b>	<b>2</b>	<b>85</b>	<b>0</b>	<b>4</b>	<b>51</b>	<b>8</b>	<b>0</b>	<b>63</b>	<b>0</b>	<b>218</b>
3:00AM	2	6	3	0	11	0	0	2	2	0	4	0	2	14	1	0	17	0	0	21	1	0	22	0	54
3:15AM	1	9	2	0	12	0	0	4	0	0	4	0	2	16	0	0	18	0	0	11	0	0	11	0	45
3:30AM	2	5	2	0	9	0	2	0	0	0	2	0	2	8	0	0	10	0	0	20	2	0	22	0	43
3:45AM	1	4	0	0	5	0	0	7	0	0	7	0	3	17	1	1	22	0	2	12	1	0	15	0	49
<b>Hourly Total</b>	<b>6</b>	<b>24</b>	<b>7</b>	<b>0</b>	<b>37</b>	<b>0</b>	<b>2</b>	<b>13</b>	<b>2</b>	<b>0</b>	<b>17</b>	<b>0</b>	<b>9</b>	<b>55</b>	<b>2</b>	<b>1</b>	<b>67</b>	<b>0</b>	<b>2</b>	<b>64</b>	<b>4</b>	<b>0</b>	<b>70</b>	<b>0</b>	<b>191</b>
4:00AM	1	0	5	0	6	0	1	6	3	0	10	0	1	18	1	0	20	0	0	15	2	0	17	0	53
4:15AM	0	3	4	0	7	0	0	9	0	0	9	0	3	25	0	0	28	0	3	18	4	0	25	0	69
4:30AM	1	8	5	1	15	0	0	22	1	0	23	0	5	28	1	1	35	0	1	34	3	0	38	0	111
4:45AM	2	11	6	0	19	0	3	20	1	0	24	0	4	36	2	0	42	0	4	40	4	0	48	0	133
<b>Hourly Total</b>	<b>4</b>	<b>22</b>	<b>20</b>	<b>1</b>	<b>47</b>	<b>0</b>	<b>4</b>	<b>57</b>	<b>5</b>	<b>0</b>	<b>66</b>	<b>0</b>	<b>13</b>	<b>107</b>	<b>4</b>	<b>1</b>	<b>125</b>	<b>0</b>	<b>8</b>	<b>107</b>	<b>13</b>	<b>0</b>	<b>128</b>	<b>0</b>	<b>366</b>
5:00AM	1	14	6	0	21	0	1	25	2	1	29	0	9	55	0	1	65	0	1	59	5	1	66	0	181
5:15AM	2	8	12	0	22	0	1	27	1	0	29	0	14	86	0	0	100	0	2	82	7	0	91	0	242
5:30AM	12	17	15	0	44	0	1	52	5	0	58	0	13	85	1	0	99	0	6	86	6	0	98	0	299
5:45AM	7	20	16	0	43	0	0	54	10	0	64	0	21	120	1	0	142	0	8	87	8	0	103	0	352
<b>Hourly Total</b>	<b>22</b>	<b>59</b>	<b>49</b>	<b>0</b>	<b>130</b>	<b>0</b>	<b>3</b>	<b>158</b>	<b>18</b>	<b>1</b>	<b>180</b>	<b>0</b>	<b>57</b>	<b>346</b>	<b>2</b>	<b>1</b>	<b>406</b>	<b>0</b>	<b>17</b>	<b>314</b>	<b>26</b>	<b>1</b>	<b>358</b>	<b>0</b>	<b>1074</b>
6:00AM	7	36	22	0	65	0	3	58	9	0	70	0	20	163	0	0	183	0	1	112	15	0	128	0	446
6:15AM	12	28	19	0	59	0	1	76	6	1	84	0	24	199	0	0	223	0	9	190	13	0	212	0	578
6:30AM	11	41	16	0	68	0	4	104	9	0	117	0	28	154	0	0	182	0	10	174	26	0	210	1	577
6:45AM	16	47	37	1	101	1	6	116	8	0	130	1	29	187	1	0	217	0	12	240	34	0	286	0	734
<b>Hourly Total</b>	<b>46</b>	<b>152</b>	<b>94</b>	<b>1</b>	<b>293</b>	<b>1</b>	<b>14</b>	<b>354</b>	<b>32</b>	<b>1</b>	<b>401</b>	<b>1</b>	<b>101</b>	<b>703</b>	<b>1</b>	<b>0</b>	<b>805</b>	<b>0</b>	<b>32</b>	<b>716</b>	<b>88</b>	<b>0</b>	<b>836</b>	<b>1</b>	<b>2335</b>
7:00AM	25	63	48	0	136	0	5	114	11	0	130	0	27	169	2	0	198	0	11	271	42	1	325	0	789
7:15AM	33	92	73	2	200	1	11	160	17	0	188	0	36	202	3	0	241	0	16	360	56	1	433	0	1062
7:30AM	38	92	39	0	169	2	17	189	27	0	233	0	34	316	5	0	355	0	29	388	63	0	480	0	1237
7:45AM	34	116	53	4	207	0	14	224	36	0	274	0	63	310	4	0	377	1	32	397	53	2	484	0	1342
<b>Hourly Total</b>	<b>130</b>	<b>363</b>	<b>213</b>	<b>6</b>	<b>712</b>	<b>3</b>	<b>47</b>	<b>687</b>	<b>91</b>	<b>0</b>	<b>825</b>	<b>0</b>	<b>160</b>	<b>997</b>	<b>14</b>	<b>0</b>	<b>1171</b>	<b>1</b>	<b>88</b>	<b>1416</b>	<b>214</b>	<b>4</b>	<b>1722</b>	<b>0</b>	<b>4430</b>
8:00AM	34	84	44	2	164	0	13	154	22	0	189	0	59	410	5	0	474	1	27	420	48	0	495	0	1322
8:15AM	34	80	64	4	182	0	19	205	22	0	246	0	53	380	6	0	439	0	30	439	56	0	525	0	1392
8:30AM	29	96	57	2	184	1	9	158	12	1	180	0	65	298	3	0	366	0	23	331	55	0	409	0	1139
8:45AM	31	53	53	1	138	0	5	177	21	1	204	0	65	307	10	0	382	2	22	304	53	2	381	0	1105
<b>Hourly Total</b>	<b>128</b>	<b>313</b>	<b>218</b>	<b>9</b>	<b>668</b>	<b>1</b>	<b>46</b>	<b>694</b>	<b>77</b>	<b>2</b>	<b>819</b>	<b>0</b>	<b>242</b>	<b>1395</b>	<b>24</b>	<b>0</b>	<b>1661</b>	<b>3</b>	<b>102</b>	<b>1494</b>	<b>212</b>	<b>2</b>	<b>1810</b>	<b>0</b>	<b>4958</b>
9:00AM	49	98	46	3	196	0	15	136	25	0	176	1	47	253	5	0	305	1	22	236	37	1	296	0	973
9:15AM	31	75	52	5	163	0	15	130	16	0	161	0	48	252	8	1	309	0	29	264	45	2	340	0	973
9:30AM	32	75	56	7	170	0	14	121	18	0	153	0	58	231	3	0	292	0	27	232	41	2	302	0	917
9:45AM	27	62	58	6	153	0	10	114	16	1	141	0	46	242	5	1	294	0	25	249	35	0	309	0	897
<b>Hourly Total</b>	<b>139</b>	<b>310</b>	<b>212</b>	<b>21</b>	<b>682</b>	<b>0</b>	<b>54</b>	<b>501</b>	<b>75</b>	<b>1</b>	<b>631</b>	<b>1</b>	<b>199</b>	<b>978</b>	<b>21</b>	<b>2</b>	<b>1200</b>	<b>1</b>	<b>103</b>	<b>981</b>	<b>158</b>	<b>5</b>	<b>1247</b>	<b>0</b>	<b>3760</b>
10:00AM	44	85	42	3	174	0	15	126	14	1	156	0	59	190	14	0	263	0	22	188	37	4	251	0	844
10:15AM	36	63	44	3	146	0	11	88	16	0	115	1	66	209	5	0	280	0	18	280	40	0	338	1	879
10:30AM	50	98	58	5	211	1	9	113	18	0	140	1	59	176	10	0	245	0	16	183	42	1	242	0	838
10:45AM	27	81	54	2	164	1	12	107	17	2	138	5	77	255	7	0	339	0	25	240	51	2	318	0	959
<b>Hourly Total</b>	<b>157</b>	<b>327</b>	<b>198</b>	<b>13</b>	<b>695</b>	<b>2</b>	<b>47</b>	<b>434</b>	<b>65</b>	<b>3</b>	<b>549</b>	<b>7</b>	<b>261</b>	<b>830</b>	<b>36</b>	<b>0</b>	<b>1127</b>	<b>0</b>	<b>81</b>	<b>891</b>	<b>170</b>	<b>7</b>	<b>1149</b>	<b>1</b>	<b>3520</b>
11:00AM	49	96	60	6	211	0	10	144	22	0															

Leg Direction	Belt Line Road Eastbound						Belt Line Road Westbound						Preston Road Northbound						Preston Road Southbound						Int
	L	T	R	U	App	Ped*	L	T	R	U	App	Ped*	L	T	R	U	App	Ped*	L	T	R	U	App	Ped*	
12:30PM	61	137	91	4	293	1	19	108	27	1	155	1	88	244	15	1	348	0	31	267	53	0	351	0	1147
12:45PM	52	112	103	7	274	0	22	115	28	0	165	1	104	304	14	0	422	0	31	262	47	3	343	0	1204
Hourly Total	223	523	383	32	1161	1	73	503	114	2	692	2	385	1065	59	3	1512	2	121	986	205	7	1319	1	4684
1:00PM	67	155	82	5	309	2	21	132	20	1	174	0	99	239	16	1	355	2	41	273	51	1	366	2	1204
1:15PM	69	124	88	7	288	2	27	130	23	0	180	0	95	237	12	0	344	1	23	246	67	0	336	0	1148
1:30PM	53	141	72	11	277	0	20	106	16	1	143	2	86	278	14	2	380	0	34	287	60	1	382	1	1182
1:45PM	55	146	80	6	287	0	17	120	23	1	161	0	96	288	12	0	396	1	32	244	44	3	323	0	1167
Hourly Total	244	566	322	29	1161	4	85	488	82	3	658	2	376	1042	54	3	1475	4	130	1050	222	5	1407	3	4701
2:00PM	66	167	77	11	321	0	16	121	28	1	166	0	79	221	14	1	315	0	27	230	58	0	315	0	1117
2:15PM	59	201	82	12	354	0	9	116	28	1	154	0	90	267	11	0	368	0	26	263	50	0	339	1	1215
2:30PM	69	153	80	9	311	0	11	113	27	1	152	0	84	298	14	4	400	0	17	299	46	1	363	0	1226
2:45PM	80	194	71	13	358	0	10	117	26	2	155	0	90	269	8	0	367	0	37	300	56	0	393	0	1273
Hourly Total	274	715	310	45	1344	0	46	467	109	5	627	0	343	1055	47	5	1450	0	107	1092	210	1	1410	1	4831
3:00PM	65	190	72	4	331	1	15	145	16	1	177	0	80	285	13	0	378	1	35	253	34	1	323	2	1209
3:15PM	69	198	86	11	364	0	20	111	24	0	155	0	79	355	17	0	451	2	36	302	42	3	383	0	1353
3:30PM	55	162	98	8	323	1	16	158	18	0	192	0	83	335	9	0	427	0	32	390	44	0	466	0	1408
3:45PM	60	212	79	9	360	0	18	176	26	0	220	0	106	302	9	0	417	0	33	308	42	1	384	1	1381
Hourly Total	249	762	335	32	1378	2	69	590	84	1	744	0	348	1277	48	0	1673	3	136	1253	162	5	1556	3	5351
4:00PM	65	230	84	6	385	1	16	139	27	0	182	0	112	344	10	0	466	2	32	257	39	2	330	0	1363
4:15PM	60	206	83	7	356	1	14	139	27	0	180	2	100	396	16	0	512	0	33	311	50	2	396	0	1444
4:30PM	77	240	75	2	394	0	22	157	41	0	220	0	118	369	13	0	500	0	38	309	54	0	401	0	1515
4:45PM	81	230	81	7	399	0	13	142	33	1	189	1	113	422	20	0	555	0	29	311	50	1	391	2	1534
Hourly Total	283	906	323	22	1534	2	65	577	128	1	771	3	443	1531	59	0	2033	2	132	1188	193	5	1518	2	5856
5:00PM	82	215	80	13	390	0	25	154	12	0	191	1	114	431	10	0	555	2	30	350	61	0	441	0	1577
5:15PM	77	264	91	9	441	2	24	157	24	0	205	0	104	434	13	0	551	0	32	303	62	0	397	1	1594
5:30PM	82	227	75	14	398	0	23	130	23	0	176	1	116	488	17	0	621	0	38	353	70	1	462	0	1657
5:45PM	79	205	76	4	364	0	22	162	26	0	210	0	89	416	10	0	515	0	41	297	55	1	394	0	1483
Hourly Total	320	911	322	40	1593	2	94	603	85	0	782	2	423	1769	50	0	2242	2	141	1303	248	2	1694	1	6311
6:00PM	77	194	87	6	364	1	20	159	27	0	206	2	92	472	14	1	579	0	28	287	65	0	380	0	1529
6:15PM	75	163	97	7	342	0	17	133	20	0	170	0	107	461	12	0	580	0	34	307	68	0	409	0	1501
6:30PM	64	235	88	6	393	0	12	143	21	1	177	0	88	302	22	0	412	0	28	257	44	1	330	0	1312
6:45PM	68	187	83	7	345	1	7	120	23	1	151	0	98	295	11	0	404	0	32	212	59	3	306	1	1206
Hourly Total	284	779	355	26	1444	2	56	555	91	2	704	2	385	1530	59	1	1975	0	122	1063	236	4	1425	1	5548
7:00PM	68	131	91	5	295	0	15	100	15	2	132	0	76	252	10	0	338	0	20	210	58	0	288	0	1053
7:15PM	65	146	88	6	305	0	9	105	9	0	123	0	82	245	12	1	340	0	23	212	35	1	271	0	1039
7:30PM	47	136	74	4	261	0	19	98	12	1	130	0	83	196	10	1	290	0	16	168	35	1	220	1	901
7:45PM	51	129	55	3	238	0	8	77	9	0	94	0	79	215	12	0	306	0	28	184	46	0	258	0	896
Hourly Total	231	542	308	18	1099	0	51	380	45	3	479	0	320	908	44	2	1274	0	87	774	174	2	1037	1	3889
8:00PM	56	116	70	0	242	0	11	77	11	0	99	0	63	180	5	1	249	0	16	161	34	0	211	1	801
8:15PM	54	119	63	4	240	2	12	59	10	0	81	0	63	233	12	0	308	2	21	175	36	4	236	2	865
8:30PM	39	98	54	7	198	0	12	73	10	0	95	0	55	170	5	0	230	0	16	166	27	1	210	0	733
8:45PM	32	68	48	7	155	0	12	63	13	1	89	0	59	171	5	1	236	0	20	138	24	1	183	0	663
Hourly Total	181	401	235	18	835	2	47	272	44	1	364	0	240	754	27	2	1023	2	73	640	121	6	840	3	3062
9:00PM	48	120	41	2	211	0	8	62	11	0	81	0	55	136	6	1	198	0	20	126	31	2	179	1	669
9:15PM	28	83	46	4	161	0	3	60	7	0	70	0	56	142	5	1	204	0	20	127	23	2	172	1	607
9:30PM	32	87	34	3	156	0	7	43	8	0	58	0	30	161	10	3	204	0	16	147	23	1	187	2	605
9:45PM	23	96	28	3	150	0	2	47	8	0	57	0	32	129	5	0	166	0	22	130	20	0	172	0	545
Hourly Total	131	386	149	12	678	0	20	212	34	0	266	0	173	568	26	5	772	0	78	530	97	5	710	4	2426
10:00PM	25	87	46	1	159	0	4	38	4	0	46	0	36	145	3	0	184	0	11	136	22	0	169	0	558
10:15PM	20	85	30	1	136	0	1	45	6	0	52	0	38	109	6	0	153	0	17	112	15	1	145	0	486
10:30PM	24	71	37	1	133	0	0	26	7	0	33	0	35	120	2	1	158	0	16	99	8	0	123	0	447
10:45PM	19	70	27	2	118	0	1	27	7	0	35	0	26	83	7	0	116	0	10	91	10	1	112	0	381
Hourly Total	88	313	140	5	546	0	6	136	24	0	166	0	135	457	18	1	611	0	54	438	55	2	549	0	1872
11:00PM	7	69	17	1	94	0	2	28	2	1	33	0	17	90	5	3	115	0	11	79	7	0	97	0	339
11:15PM	9	33	22	1	65	0	6	23	4	1	34	0	28	67	2	1	98	0	9	69	12	0	90	0	287
11:30PM	6	43	24	3	76	0	2	20	9	0	31	0	14	62	3	0	79	0	9	58	8	0	75	0	261
11:45PM	4	46	16	2	68	0	1	18	3	1	23	0	15	64	0	0	79	0	6	51	11	0	68	0	238
Hourly Total	26	191	79	7	303	0	11	89	18	3	121	0	74	283	10	4	371	0	35	257	38	0	330	0	1125
<b>Total</b>	<b>3385</b>	<b>9122</b>	<b>4615</b>	<b>365</b>	<b>17487</b>	<b>24</b>	<b>904</b>	<b>8397</b>	<b>1334</b>	<b>30</b>	<b>10665</b>	<b>22</b>	<b>5198</b>	<b>18874</b>	<b>660</b>	<b>40</b>	<b>24772</b>	<b>25</b>	<b>1786</b>	<b>17666</b>	<b>3088</b>	<b>66</b>	<b>22606</b>	<b>25</b>	<b>75530</b>
<b>% Approach</b>	19.4%	52.2%	26.4%	2.1%	-	-	8.5%	78.7%	12.5%	0.3%	-	-	21.0%	76.2%	2.7%	0.2%	-	-	7.9%	78.1%	13.7%	0.3%	-	-	-
<b>% Total</b>	4.5%	12.1%	6.1%	0.5%	23.2%	-	1.2%	11.1%	1.8%	0%	14.1%	-	6.9%	25.0%	0.9%	0.1%	32.8%	-	2.4%	23.4%	4.1%	0.1%	29.9%	-	-
<b>Lights</b>	3340	8990	4573	365	17268	-	897	8265	1318																

Leg Direction	Belt Line Road Eastbound						Belt Line Road Westbound						Preston Road Northbound						Preston Road Southbound						
Time	L	T	R	U	App	Ped*	L	T	R	U	App	Ped*	L	T	R	U	App	Ped*	L	T	R	U	App	Ped*	Int
<b>% Buses and Single-Unit Trucks</b>	1.2%	1.2%	0.7%	0%	<b>1.1%</b>	-	0.8%	1.3%	1.2%	0%	<b>1.3%</b>	-	0.8%	1.0%	2.0%	0%	<b>1.0%</b>	-	1.1%	0.9%	1.5%	0%	<b>1.0%</b>	-	1.1%
Pedestrians	-	-	-	-	-	24	-	-	-	-	-	22	-	-	-	-	-	25	-	-	-	-	-	25	-
% Pedestrians	-	-	-	-	-	-100%	-	-	-	-	-	-100%	-	-	-	-	-	-100%	-	-	-	-	-	-100%	-
Bicycles on Crosswalk	-	-	-	-	-	0	-	-	-	-	-	0	-	-	-	-	-	0	-	-	-	-	-	0	-
% Bicycles on Crosswalk	-	-	-	-	-	0%	-	-	-	-	-	0%	-	-	-	-	-	0%	-	-	-	-	-	0%	-

\*Pedestrians and Bicycles on Crosswalk. L: Left, R: Right, T: Thru, U: U-Turn

**13. Belt Line Road at Preston Road - TMC**

Wed May 12, 2021

AM Peak (7:30 AM - 8:30 AM)

All Classes (Lights, Articulated Trucks, Buses and Single-Unit Trucks, Pedestrians, Bicycles on Crosswalk)

All Movements

ID: 835154, Location: 32.953954, -96.804067



Provided by: C. J. Hensch & Associates Inc.  
5215 Sycamore Ave.,  
Pasadena, TX, 77503, US

Leg Direction	Belt Line Road Eastbound						Belt Line Road Westbound						Preston Road Northbound						Preston Road Southbound						Int
	L	T	R	U	App	Ped*	L	T	R	U	App	Ped*	L	T	R	U	App	Ped*	L	T	R	U	App	Ped*	
2021-05-12 7:30AM	38	92	39	0	169	2	17	189	27	0	233	0	34	316	5	0	355	0	29	388	63	0	480	0	1237
7:45AM	34	116	53	4	207	0	14	224	36	0	274	0	63	310	4	0	377	1	32	397	53	2	484	0	1342
8:00AM	34	84	44	2	164	0	13	154	22	0	189	0	59	410	5	0	474	1	27	420	48	0	495	0	1322
8:15AM	34	80	64	4	182	0	19	205	22	0	246	0	53	380	6	0	439	0	30	439	56	0	525	0	1392
<b>Total</b>	140	372	200	10	722	2	63	772	107	0	942	0	209	1416	20	0	1645	2	118	1644	220	2	1984	0	5293
<b>% Approach</b>	19.4%	51.5%	27.7%	1.4%	-	-	6.7%	82.0%	11.4%	0%	-	-	12.7%	86.1%	1.2%	0%	-	-	5.9%	82.9%	11.1%	0.1%	-	-	-
<b>% Total</b>	2.6%	7.0%	3.8%	0.2%	13.6%	-	1.2%	14.6%	2.0%	0%	17.8%	-	3.9%	26.8%	0.4%	0%	31.1%	-	2.2%	31.1%	4.2%	0%	37.5%	-	-
<b>PHF</b>	0.921	0.802	0.781	0.625	0.872	-	0.829	0.862	0.743	-	0.859	-	0.829	0.863	0.833	-	0.868	-	0.922	0.936	0.873	0.250	0.945	-	0.951
<b>Lights</b>	137	363	200	10	710	-	61	765	106	0	932	-	202	1390	19	0	1611	-	117	1635	218	2	1972	-	5225
<b>% Lights</b>	97.9%	97.6%	100%	100%	98.3%	-	96.8%	99.1%	99.1%	0%	98.9%	-	96.7%	98.2%	95.0%	0%	97.9%	-	99.2%	99.5%	99.1%	100%	99.4%	-	98.7%
<b>Articulated Trucks</b>	0	2	0	0	2	-	0	0	0	0	0	-	0	1	0	0	1	-	0	4	0	0	4	-	7
<b>% Articulated Trucks</b>	0%	0.5%	0%	0%	0.3%	-	0%	0%	0%	0%	0%	-	0%	0.1%	0%	0%	0.1%	-	0%	0.2%	0%	0%	0.2%	-	0.1%
<b>Buses and Single-Unit Trucks</b>	3	7	0	0	10	-	2	7	1	0	10	-	7	25	1	0	33	-	1	5	2	0	8	-	61
<b>% Buses and Single-Unit Trucks</b>	2.1%	1.9%	0%	0%	1.4%	-	3.2%	0.9%	0.9%	0%	1.1%	-	3.3%	1.8%	5.0%	0%	2.0%	-	0.8%	0.3%	0.9%	0%	0.4%	-	1.2%
<b>Pedestrians</b>	-	-	-	-	-	2	-	-	-	-	-	0	-	-	-	-	-	2	-	-	-	-	-	0	-
<b>% Pedestrians</b>	-	-	-	-	-	100%	-	-	-	-	-	-	-	-	-	-	-	100%	-	-	-	-	-	-	-
<b>Bicycles on Crosswalk</b>	-	-	-	-	-	0	-	-	-	-	-	0	-	-	-	-	-	0	-	-	-	-	-	0	-
<b>% Bicycles on Crosswalk</b>	-	-	-	-	-	0%	-	-	-	-	-	-	-	-	-	-	-	0%	-	-	-	-	-	-	-

\*Pedestrians and Bicycles on Crosswalk. L: Left, R: Right, T: Thru, U: U-Turn

13. Belt Line Road at Preston Road - TMC

Wed May 12, 2021

Midday Peak (12 PM - 1 PM)

All Classes (Lights, Articulated Trucks, Buses and Single-Unit Trucks, Pedestrians, Bicycles on Crosswalk)

All Movements

ID: 835154, Location: 32.953954, -96.804067



Provided by: C. J. Hensch & Associates Inc.  
5215 Sycamore Ave.,  
Pasadena, TX, 77503, US

Leg Direction	Belt Line Road Eastbound						Belt Line Road Westbound						Preston Road Northbound						Preston Road Southbound						Int
	L	T	R	U	App	Ped*	L	T	R	U	App	Ped*	L	T	R	U	App	Ped*	L	T	R	U	App	Ped*	
2021-05-12 12:00PM	54	134	90	9	287	0	13	145	29	0	187	0	92	269	16	1	378	1	22	238	47	3	310	1	1162
12:15PM	56	140	99	12	307	0	19	135	30	1	185	0	101	248	14	1	364	1	37	219	58	1	315	0	1171
12:30PM	61	137	91	4	293	1	19	108	27	1	155	1	88	244	15	1	348	0	31	267	53	0	351	0	1147
12:45PM	52	112	103	7	274	0	22	115	28	0	165	1	104	304	14	0	422	0	31	262	47	3	343	0	1204
<b>Total</b>	223	523	383	32	1161	1	73	503	114	2	692	2	385	1065	59	3	1512	2	121	986	205	7	1319	1	4684
<b>% Approach</b>	19.2%	45.0%	33.0%	2.8%	-	-	10.5%	72.7%	16.5%	0.3%	-	-	25.5%	70.4%	3.9%	0.2%	-	-	9.2%	74.8%	15.5%	0.5%	-	-	-
<b>% Total</b>	4.8%	11.2%	8.2%	0.7%	24.8%	-	1.6%	10.7%	2.4%	0%	14.8%	-	8.2%	22.7%	1.3%	0.1%	32.3%	-	2.6%	21.1%	4.4%	0.1%	28.2%	-	-
<b>PHF</b>	0.914	0.934	0.930	0.667	0.945	-	0.830	0.867	0.950	0.500	0.925	-	0.925	0.876	0.922	0.750	0.896	-	0.818	0.923	0.884	0.583	0.939	-	0.973
<b>Lights</b>	219	516	378	32	1145	-	73	491	113	2	679	-	377	1052	59	3	1491	-	119	969	201	7	1296	-	4611
<b>% Lights</b>	98.2%	98.7%	98.7%	100%	98.6%	-	100%	97.6%	99.1%	100%	98.1%	-	97.9%	98.8%	100%	100%	98.6%	-	98.3%	98.3%	98.0%	100%	98.3%	-	98.4%
<b>Articulated Trucks</b>	0	1	1	0	2	-	0	3	0	0	3	-	1	3	0	0	4	-	0	2	1	0	3	-	12
<b>% Articulated Trucks</b>	0%	0.2%	0.3%	0%	0.2%	-	0%	0.6%	0%	0%	0.4%	-	0.3%	0.3%	0%	0%	0.3%	-	0%	0.2%	0.5%	0%	0.2%	-	0.3%
<b>Buses and Single-Unit Trucks</b>	4	6	4	0	14	-	0	9	1	0	10	-	7	10	0	0	17	-	2	15	3	0	20	-	61
<b>% Buses and Single-Unit Trucks</b>	1.8%	1.1%	1.0%	0%	1.2%	-	0%	1.8%	0.9%	0%	1.4%	-	1.8%	0.9%	0%	0%	1.1%	-	1.7%	1.5%	1.5%	0%	1.5%	-	1.3%
Pedestrians	-	-	-	-	-	1	-	-	-	-	-	2	-	-	-	-	-	2	-	-	-	-	-	-	1
<b>% Pedestrians</b>	-	-	-	-	-	100%	-	-	-	-	-	100%	-	-	-	-	-	100%	-	-	-	-	-	-	100%
Bicycles on Crosswalk	-	-	-	-	-	0	-	-	-	-	-	0	-	-	-	-	-	0	-	-	-	-	-	-	0
<b>% Bicycles on Crosswalk</b>	-	-	-	-	-	0%	-	-	-	-	-	0%	-	-	-	-	-	0%	-	-	-	-	-	-	0%

\*Pedestrians and Bicycles on Crosswalk. L: Left, R: Right, T: Thru, U: U-Turn



13. Belt Line Road at Preston Road - TMC

Wed May 12, 2021

PM Peak (4:45 PM - 5:45 PM) - Overall Peak Hour

All Classes (Lights, Articulated Trucks, Buses and Single-Unit Trucks, Pedestrians, Bicycles on Crosswalk)

All Movements

ID: 835154, Location: 32.953954, -96.804067



Provided by: C. J. Hensch & Associates Inc.  
5215 Sycamore Ave.,  
Pasadena, TX, 77503, US

Leg Direction	Belt Line Road Eastbound						Belt Line Road Westbound						Preston Road Northbound						Preston Road Southbound						Int
	L	T	R	U	App	Ped*	L	T	R	U	App	Ped*	L	T	R	U	App	Ped*	L	T	R	U	App	Ped*	
2021-05-12 4:45PM	81	230	81	7	399	0	13	142	33	1	189	1	113	422	20	0	555	0	29	311	50	1	391	2	1534
5:00PM	82	215	80	13	390	0	25	154	12	0	191	1	114	431	10	0	555	2	30	350	61	0	441	0	1577
5:15PM	77	264	91	9	441	2	24	157	24	0	205	0	104	434	13	0	551	0	32	303	62	0	397	1	1594
5:30PM	82	227	75	14	398	0	23	130	23	0	176	1	116	488	17	0	621	0	38	353	70	1	462	0	1657
<b>Total</b>	322	936	327	43	1628	2	85	583	92	1	761	3	447	1775	60	0	2282	2	129	1317	243	2	1691	3	6362
<b>% Approach</b>	19.8%	57.5%	20.1%	2.6%	-	-	11.2%	76.6%	12.1%	0.1%	-	-	19.6%	77.8%	2.6%	0%	-	-	7.6%	77.9%	14.4%	0.1%	-	-	-
<b>% Total</b>	5.1%	14.7%	5.1%	0.7%	25.6%	-	1.3%	9.2%	1.4%	0%	12.0%	-	7.0%	27.9%	0.9%	0%	35.9%	-	2.0%	20.7%	3.8%	0%	26.6%	-	-
<b>PHF</b>	0.982	0.886	0.898	0.768	0.923	-	0.850	0.928	0.697	0.250	0.928	-	0.963	0.909	0.750	-	0.919	-	0.849	0.933	0.868	0.500	0.915	-	0.960
<b>Lights</b>	321	926	327	43	1617	-	84	577	91	1	753	-	446	1770	59	0	2275	-	127	1298	240	2	1667	-	6312
<b>% Lights</b>	99.7%	98.9%	100%	100%	99.3%	-	98.8%	99.0%	98.9%	100%	98.9%	-	99.8%	99.7%	98.3%	0%	99.7%	-	98.4%	98.6%	98.8%	100%	98.6%	-	99.2%
<b>Articulated Trucks</b>	0	0	0	0	0	-	0	1	0	0	1	-	0	1	0	0	1	-	0	2	0	0	2	-	4
<b>% Articulated Trucks</b>	0%	0%	0%	0%	0%	-	0%	0.2%	0%	0%	0.1%	-	0%	0.1%	0%	0%	0%	-	0%	0.2%	0%	0%	0.1%	-	0.1%
<b>Buses and Single-Unit Trucks</b>	1	10	0	0	11	-	1	5	1	0	7	-	1	4	1	0	6	-	2	17	3	0	22	-	46
<b>% Buses and Single-Unit Trucks</b>	0.3%	1.1%	0%	0%	0.7%	-	1.2%	0.9%	1.1%	0%	0.9%	-	0.2%	0.2%	1.7%	0%	0.3%	-	1.6%	1.3%	1.2%	0%	1.3%	-	0.7%
<b>Pedestrians</b>	-	-	-	-	-	2	-	-	-	-	-	3	-	-	-	-	-	2	-	-	-	-	-	3	-
<b>% Pedestrians</b>	-	-	-	-	-	100%	-	-	-	-	-	100%	-	-	-	-	-	100%	-	-	-	-	-	100%	-
<b>Bicycles on Crosswalk</b>	-	-	-	-	-	0	-	-	-	-	-	0	-	-	-	-	-	0	-	-	-	-	-	0	-
<b>% Bicycles on Crosswalk</b>	-	-	-	-	-	0%	-	-	-	-	-	0%	-	-	-	-	-	0%	-	-	-	-	-	0%	-

\*Pedestrians and Bicycles on Crosswalk. L: Left, R: Right, T: Thru, U: U-Turn

### NB Berry Trail North of Belt Line Road

Date Began:  
5/12/2021

TIME	0:00	0:15	0:30	0:45	Total
0:00	2	0	0	1	3
1:00	2	3	0	2	7
2:00	1	0	2	0	3
3:00	0	0	1	0	1
4:00	0	0	3	0	3
5:00	2	1	1	0	4
6:00	2	1	2	2	7
7:00	4	4	10	9	27
8:00	10	6	5	8	29
9:00	11	7	3	10	31
10:00	12	7	9	6	34
11:00	12	11	10	13	46
12:00	16	21	13	7	57
13:00	14	11	13	14	52
14:00	10	14	18	11	53
15:00	15	18	17	24	74
16:00	15	23	19	22	79
17:00	20	20	16	21	77
18:00	15	13	26	20	74
19:00	13	18	14	14	59
20:00	13	11	16	10	50
21:00	8	8	8	8	32
22:00	12	4	3	5	24
23:00	5	3	3	1	12

TOTAL: 838

The A.M. peak hour from 11:45 to 12:44 is 63
The P.M. peak hour from 16:15 to 17:14 is 84

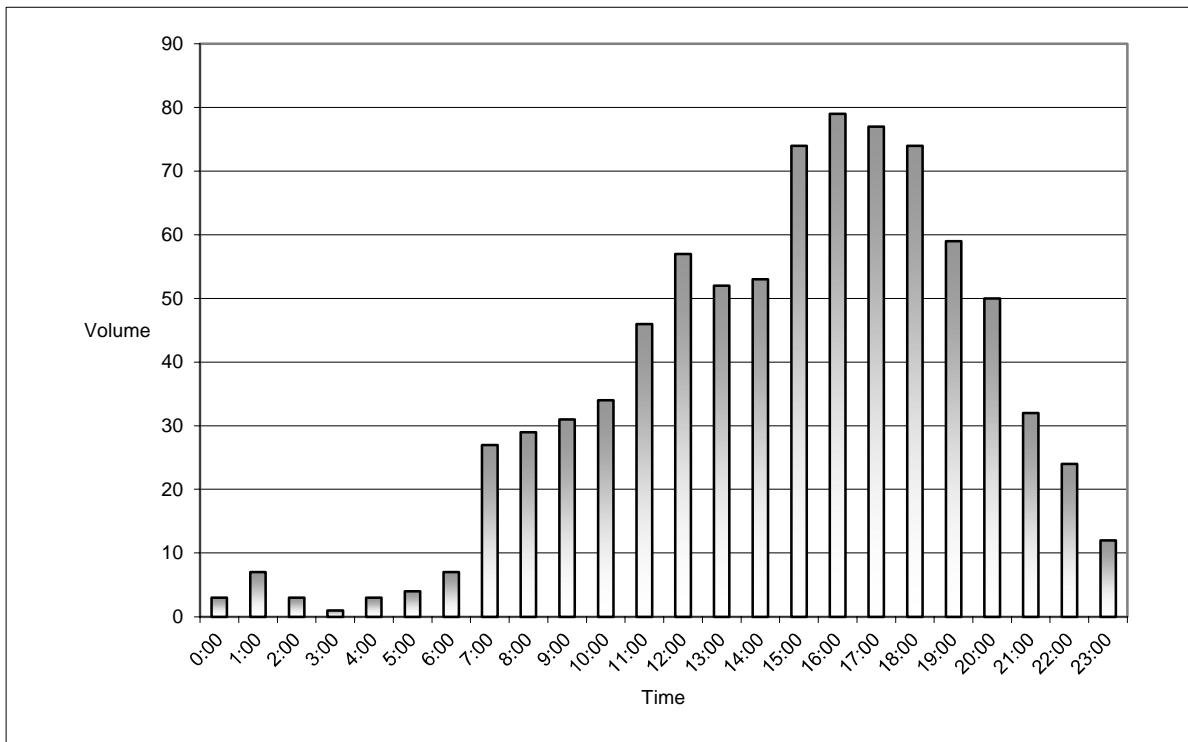

### SB Berry Trail North of Belt Line Road

Date Began:  
5/12/2021

TIME	0:00	0:15	0:30	0:45	Total
0:00	0	2	2	2	6
1:00	1	0	1	0	2
2:00	1	1	0	0	2
3:00	1	1	1	0	3
4:00	0	0	0	1	1
5:00	5	1	2	12	20
6:00	3	8	8	13	32
7:00	11	24	18	32	85
8:00	21	26	16	25	88
9:00	17	11	14	12	54
10:00	17	20	19	15	71
11:00	13	17	7	19	56
12:00	21	11	18	19	69
13:00	29	17	17	12	75
14:00	14	12	24	15	65
15:00	10	13	16	13	52
16:00	9	24	15	14	62
17:00	18	14	12	17	61
18:00	14	19	11	15	59
19:00	7	12	11	7	37
20:00	9	5	10	7	31
21:00	6	2	5	2	15
22:00	5	6	2	3	16
23:00	0	0	0	1	1

TOTAL: 963

The A.M. peak hour from 7:30 to 8:29 is 97  
The P.M. peak hour from 12:30 to 13:29 is 83

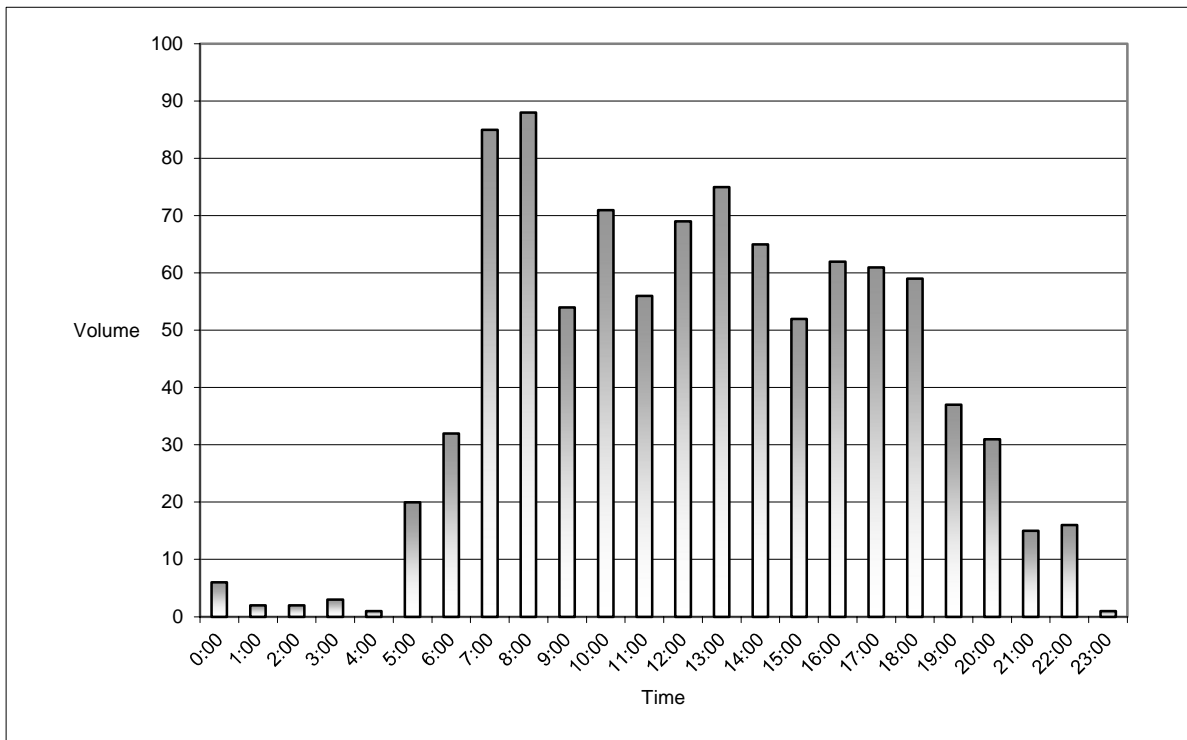

**Internal Capture Sheets**

# Internal Capture Reduction Calculations

Methodology for A.M. Peak Hour and P.M. Peak Hour  
based on the *Trip Generation Handbook*, 3rd Edition, published by the Institute of Transportation Engineers

Methodology for Daily  
based on the average of the Unconstrained Rates for the A.M. Peak Hour and P.M. Peak Hour

Pepper Square - Dallas, Texas  
Phase 1

## SUMMARY

### GROSS TRIP GENERATION

INPUT	Land Use	Daily		A.M. Peak Hour		P.M. Peak Hour	
		Enter	Exit	Enter	Exit	Enter	Exit
	Office	0	0	0	0	0	0
	Retail	0	0	0	0	0	0
	Restaurant	393	393	39	31	24	15
	Cinema/Entertainment	0	0	0	0	0	0
	Residential	812	812	33	109	31	87
	Hotel	0	0	0	0	0	0
	Gross Trips Total:	1,204	1,204	72	140	55	102

### INTERNAL TRIPS

OUTPUT	Land Use	Daily		A.M. Peak Hour		P.M. Peak Hour	
		Enter	Exit	Enter	Exit	Enter	Exit
	Office	0	0	0	0	0	0
	Retail	0	0	0	0	0	0
	Restaurant	67	43	8	1	3	3
	Cinema/Entertainment	0	0	0	0	0	0
	Residential	43	67	1	8	3	3
	Hotel	0	0	0	0	0	0
	Internal Trips Totals:	110	110	9	9	6	6
	% Reduction		9.1%		8.5%		7.6%

### EXTERNAL TRIPS

OUTPUT	Land Use	Daily		A.M. Peak Hour		P.M. Peak Hour	
		Enter	Exit	Enter	Exit	Enter	Exit
	Office	0	0	0	0	0	0
	Retail	0	0	0	0	0	0
	Restaurant	326	350	31	30	21	12
	Cinema/Entertainment	0	0	0	0	0	0
	Residential	769	745	32	101	28	84
	Hotel	0	0	0	0	0	0
	External Trips Total:	1,094	1,094	63	131	49	96

# Internal Capture Reduction Calculations

Methodology for A.M. Peak Hour and P.M. Peak Hour  
based on the *Trip Generation Handbook*, 3rd Edition, published by the Institute of Transportation Engineers

Methodology for Daily  
based on the average of the Unconstrained Rates for the A.M. Peak Hour and P.M. Peak Hour

Pepper Square - Dallas, Texas  
Phases 1 and P

## SUMMARY

### GROSS TRIP GENERATION

INPUT	Land Use	Daily		A.M. Peak Hour		P.M. Peak Hour	
		Enter	Exit	Enter	Exit	Enter	Exit
	Office	0	0	0	0	0	0
Retail	537	537	27	18	38	38	
Restaurant	1,465	1,465	39	31	87	55	
Cinema/Entertainment	0	0	0	0	0	0	
Residential	2,410	2,410	96	230	153	183	
Hotel	0	0	0	0	0	0	
Gross Trips Total:		4,412	4,412	162	279	278	276

### INTERNAL TRIPS

OUTPUT	Land Use	Daily		A.M. Peak Hour		P.M. Peak Hour	
		Enter	Exit	Enter	Exit	Enter	Exit
	Office	0	0	0	0	0	0
Retail	228	220	4	4	23	21	
Restaurant	362	317	10	3	23	29	
Cinema/Entertainment	0	0	0	0	0	0	
Residential	268	321	3	10	20	16	
Hotel	0	0	0	0	0	0	
Internal Trips Totals:		858	858	17	17	66	66
% Reduction		19.4%		7.7%		23.8%	

### EXTERNAL TRIPS

OUTPUT	Land Use	Daily		A.M. Peak Hour		P.M. Peak Hour	
		Enter	Exit	Enter	Exit	Enter	Exit
	Office	0	0	0	0	0	0
Retail	309	317	23	14	15	17	
Restaurant	1,103	1,148	29	28	64	26	
Cinema/Entertainment	0	0	0	0	0	0	
Residential	2,142	2,089	93	220	133	167	
Hotel	0	0	0	0	0	0	
External Trips Total:		3,554	3,554	145	262	212	210

# Internal Capture Reduction Calculations

Methodology for A.M. Peak Hour and P.M. Peak Hour  
based on the *Trip Generation Handbook*, 3rd Edition, published by the Institute of Transportation Engineers

Methodology for Daily  
based on the average of the Unconstrained Rates for the A.M. Peak Hour and P.M. Peak Hour

Pepper Square - Dallas, Texas  
Phases 1, P, and N

## SUMMARY

### GROSS TRIP GENERATION

INPUT	Land Use	Daily		A.M. Peak Hour		P.M. Peak Hour	
		Enter	Exit	Enter	Exit	Enter	Exit
	Office	0	0	0	0	0	0
Retail	863	863	44	30	62	61	
Restaurant	2,001	2,001	197	160	119	75	
Cinema/Entertainment	0	0	0	0	0	0	
Residential	3,445	3,445	136	308	231	245	
Hotel	0	0	0	0	0	0	
Gross Trips Total:		6,308	6,308	377	498	412	381

### INTERNAL TRIPS

OUTPUT	Land Use	Daily		A.M. Peak Hour		P.M. Peak Hour	
		Enter	Exit	Enter	Exit	Enter	Exit
	Office	0	0	0	0	0	0
Retail	367	354	7	7	37	34	
Restaurant	521	470	43	10	35	45	
Cinema/Entertainment	0	0	0	0	0	0	
Residential	393	457	9	42	30	23	
Hotel	0	0	0	0	0	0	
Internal Trips Totals:		1,281	1,281	59	59	102	102
% Reduction		20.3%		13.5%		25.7%	

### EXTERNAL TRIPS

OUTPUT	Land Use	Daily		A.M. Peak Hour		P.M. Peak Hour	
		Enter	Exit	Enter	Exit	Enter	Exit
	Office	0	0	0	0	0	0
Retail	496	509	37	23	25	27	
Restaurant	1,480	1,531	154	150	84	30	
Cinema/Entertainment	0	0	0	0	0	0	
Residential	3,052	2,988	127	266	201	222	
Hotel	0	0	0	0	0	0	
External Trips Total:		5,027	5,027	318	439	310	279



**Traffic Signal Warrant Analysis Sheets**



**TRAFFIC SIGNAL WARRANT ANALYSIS (2011 TXMUTCD)**

MAJOR STREET: Belt Line Road EB WB # OF APPROACH LANES:

MINOR STREET: Berry Trail NB SB # OF APPROACH LANES:

CITY, STATE: Dallas, TX

COMMENTS: 2021 Existing Volume

ISOLATED COMMUNITY WITH POPULATION LESS THAN 10,000 (Y OR N):

85TH PERCENTILE SPEED OR POSTED SPEED LIMIT GREATER THAN 40 MPH ON MAJOR STREET (Y OR N):

			Belt Line Road		Total	Berry Trail		Minor Street Heavy Leg
			EB Approach	WB Approach		NB Approach	SB Approach	
06:00 AM	TO	07:00 AM	375	513	889	7	32	32
07:00 AM	TO	08:00 AM	559	1051	1611	3	88	88
08:00 AM	TO	09:00 AM	533	1088	1621	6	87	87
09:00 AM	TO	10:00 AM	873	808	1681	40	54	54
10:00 AM	TO	11:00 AM	890	703	1593	71	71	71
11:00 AM	TO	12:00 PM	1160	914	2074	71	56	71
12:00 PM	TO	01:00 PM	1486	886	2372	83	69	83
01:00 PM	TO	02:00 PM	1286	729	2015	104	75	104
02:00 PM	TO	03:00 PM	1489	694	2183	95	65	95
03:00 PM	TO	04:00 PM	1526	824	2350	87	52	87
04:00 PM	TO	05:00 PM	1196	891	2087	22	58	58
05:00 PM	TO	06:00 PM	1265	902	2167	16	62	62
06:00 PM	TO	07:00 PM	933	913	1845	22	68	68
07:00 PM	TO	08:00 PM	1217	531	1748	67	37	67
08:00 PM	TO	09:00 PM	958	403	1361	67	31	67
09:00 PM	TO	10:00 PM	751	295	1046	27	15	27

Warrant	Description	Warrant Met?
1	Eight-Hour Volume	WARRANT MET
2	Four-Hour Volume	WARRANT MET
3	Peak Hour Volume	N/A
4	Pedestrian Volume	Warrant NOT Evaluated
5	School Crossing	N/A
6	Coordinated Signal System	N/A
7	Crash Experience	Warrant NOT Evaluated
8	Roadway Network	N/A
9	Intersection Near a Grade Crossing	N/A

**TRAFFIC SIGNAL WARRANT ANALYSIS (2011 TXMUTCD)**

MAJOR STREET: Belt Line Road EB WB # OF APPROACH LANES: **3**

MINOR STREET: Berry Trail NB SB # OF APPROACH LANES: **2**

CITY, STATE: Dallas, TX

COMMENTS: 2021 Existing Volume

ISOLATED COMMUNITY WITH POPULATION LESS THAN 10,000 (Y OR N): **N**  
 85TH PERCENTILE SPEED OR POSTED SPEED LIMIT GREATER THAN 40 MPH ON MAJOR STREET (Y OR N): **Y**

	MAJOR ST TWO-WAY TRAFFIC	MINOR ST TRAFFIC HEAVY LEG	WARRANT 1 - Condition A, Part 1			WARRANT 1 - Condition B, Part 1			WARRANT 1 - Condition A, Part 2			WARRANT 1 - Condition B, Part 2			WARRANT 2 Four-Hour	WARRANT 3 Peak Hour			
			MAIN LINE	SIDE STREET	BOTH MET	MAIN LINE	SIDE STREET	BOTH MET	MAIN LINE	SIDE STREET	BOTH MET	MAIN LINE	SIDE STREET	BOTH MET					
<b>THRESHOLD VALUES</b>			<b>420</b>	<b>140</b>		<b>630</b>	<b>70</b>		<b>336</b>	<b>112</b>		<b>504</b>	<b>56</b>						
06:00 AM	TO 07:00 AM	889	32	Y		Y			Y			Y							
07:00 AM	TO 08:00 AM	1,611	88	Y		Y	Y	Y	Y			Y	Y	Y					
08:00 AM	TO 09:00 AM	1,621	87	Y		Y	Y	Y	Y			Y	Y	Y					
09:00 AM	TO 10:00 AM	1,681	54	Y		Y			Y			Y							
10:00 AM	TO 11:00 AM	1,593	71	Y		Y	Y	Y	Y			Y	Y	Y					
11:00 AM	TO 12:00 PM	2,074	71	Y		Y	Y	Y	Y			Y	Y	Y					
12:00 PM	TO 01:00 PM	2,372	83	Y		Y	Y	Y	Y			Y	Y	Y	Y				
01:00 PM	TO 02:00 PM	2,015	104	Y		Y	Y	Y	Y			Y	Y	Y	Y				
02:00 PM	TO 03:00 PM	2,183	95	Y		Y	Y	Y	Y			Y	Y	Y	Y				
03:00 PM	TO 04:00 PM	2,350	87	Y		Y	Y	Y	Y			Y	Y	Y	Y				
04:00 PM	TO 05:00 PM	2,087	58	Y		Y			Y			Y	Y	Y					
05:00 PM	TO 06:00 PM	2,167	62	Y		Y			Y			Y	Y	Y					
06:00 PM	TO 07:00 PM	1,845	68	Y		Y			Y			Y	Y	Y					
07:00 PM	TO 08:00 PM	1,748	67	Y		Y			Y			Y	Y	Y					
08:00 PM	TO 09:00 PM	1,361	67	Y		Y			Y			Y	Y	Y					
09:00 PM	TO 10:00 PM	1,046	27	Y		Y			Y			Y							
		28,642	1,121			16	0	0	16	8	8	16	0	0	16	13	13	6	1
				8 HOURS NEEDED			8 HOURS NEEDED			8 HOURS NEEDED for both Condition A & B						4 HRS NEEDED	1 HR NEEDED		
				NOT SATISFIED			SATISFIED			NOT SATISFIED						SATISFIED	SATISFIED		

**Figure 4C-1. Warrant 2, Four-Hour Vehicular Volume**

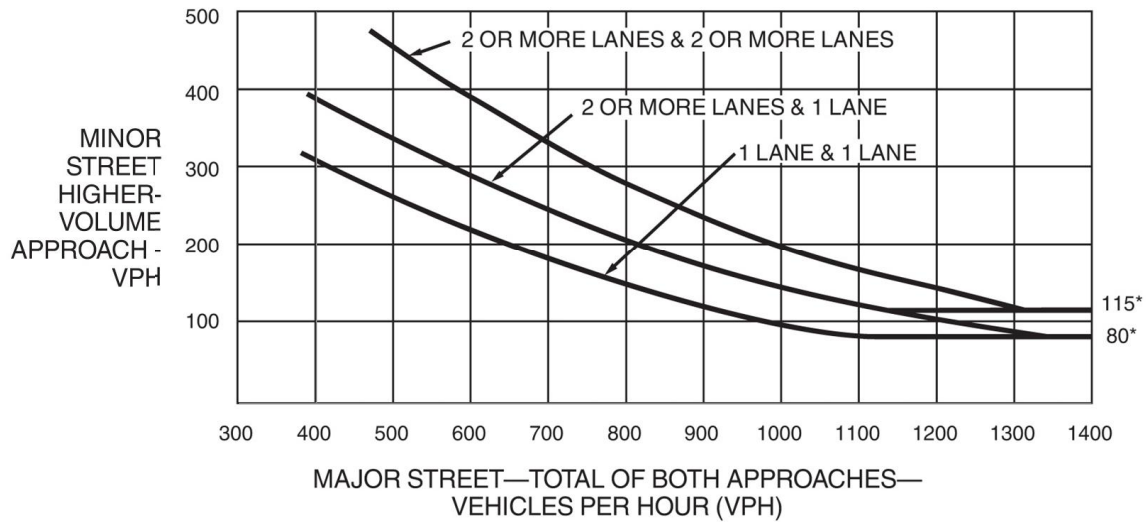

\*Note: 115 vph applies as the lower threshold volume for a minor-street approach with two or more lanes and 80 vph applies as the lower threshold volume for a minor-street approach with one lane.

**Figure 4C-2. Warrant 2, Four-Hour Vehicular Volume (70% Factor)**

(COMMUNITY LESS THAN 10,000 POPULATION OR ABOVE 40 MPH ON MAJOR STREET)

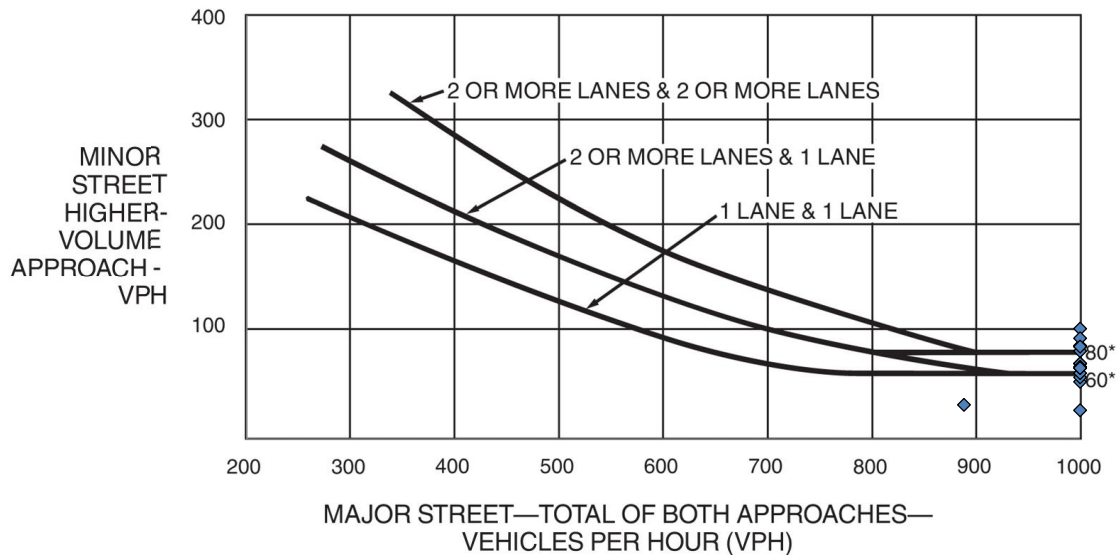

\*Note: 80 vph applies as the lower threshold volume for a minor-street approach with two or more lanes and 60 vph applies as the lower threshold volume for a minor-street approach with one lane.

# Memorandum



Date 08/15/2017  
To File  
From Kirk Houser  
Sr Program Manager  
Department of Street Services  
Transportation Operations  
Subject **Signal Warrant Study, Belt Line Road and Berry Trail.**

A signal warrant study was performed for belt line Road and Berry Trail. The intersection meets warrants for volume. A traffic signal is recommended for this intersection. Please review attached study. The City will build this signal using future city funding.

## TxMUTCD Warrant Summary

Warrant	Satisfied
1 – Eight Hour	Met
2 – Four Hour	Not Met
3 – Peak Hour	Not Applicable
4 – Pedestrian Volume	Not Studied
5 – School Crossing	Not Applicable
6 – Coordinated Signal System	Not Met
7 – Crash History	Not Met, 1 correctable in 12 month period, minimum volume threshold not met.
8 – Roadway Network	Not Met
9 – Intersection Near a Grade Crossing	Not applicable

Attachments:  
Signal Warrant Study  
Crash Data  
Approach Counts  
Speed Profile  
Sight Distance Assessment



## Traffic Signal Warrant Study

Intersection **Berry Trail and Beltline Road**  
 Request by Jeome Kasten Citizen  
 SR # 17-00214903 MCC? Y  
 Date of Request 5/8/2017

### General Intersection Information

#### Major Street

Name: Belt Line Road  
 # lanes 3 Speed 44 Type 85th Percentile  
 Street Classification Major Arterial

#### Minor Street

Name: Berry Trail  
 # lanes 2 % of Right Turns 15%  
 Street Classification Residential/Commercial Drive

**Total Number of Intersection Approaches** 4

Is this intersection near an office complex, manufacturing plant, industrial complex, or plants, industrial complexes, or high-occupancy vehicle facilities that attract or discharge large numbers of vehicles over a short time? No

**Distance to nearest traffic signal** 1162 ft

### Accident History

(attach full history)

No. of Right-Angle Accidents: 1  
 No. of Left-Turn Accidents: 0  
 No. of Other Accidents Potentially Correctible with Signal: 0  
 Total Potentially Correctible: 1



## Traffic Signal Warrant Study

Location **Berry Trail** crossing **Belt Line Road**  
Minor street Major Street

## Information about Traffic Signals

### Advantages of Traffic Signals

- Signals offer the maximum degree of control at intersections. They relay messages of both what to do and what not to do. The primary function of any traffic signal is to assign right of way to conflicting movements of traffic at an intersection, and it does this by permitting conflicting streams of traffic to share the same intersection by means of time separation.
- By alternately assigning right of way to various traffic movements, signals provide for the orderly movement of conflicting flows. They may interrupt extremely heavy flows to permit the crossing of minor movements that could not otherwise move safely through the intersection.
- When properly timed, traffic signals increase the traffic handling capacity of an intersection, and when installed under conditions that justify its use, it is a valuable device for improving the safety and efficiency of both pedestrian and vehicular traffic. In particular, signals may reduce certain types of accidents, most notably the angle (broadside) collision.

### Disadvantages of Traffic Signals

- While many people realize that traffic signals can reduce the number of angle collisions at an intersection, few realize that signals can also cause an increase in other types of accidents. For example, it has been well documented that other types of accidents, notably rear-end collisions, usually increase when a signal is installed.
- Normally, traffic engineers are willing to trade off an increase in rear-end collisions for a decrease in the more severe angle accidents; however, when there is no angle accident problem at an intersection, there is nothing to trade off, and the installation of traffic signals can actually cause a deterioration in the overall safety at the intersection. Traffic signals should not be considered a "cure-all" for traffic congestion, and the primary goal of all traffic engineers is to attain the safest and most efficient traffic flow feasible.
- In addition to an increase in accident frequency, unjustified traffic signals can also cause excessive delays, disobedience of signals and diversion of traffic to inadequate alternate routes.
- Traffic signals are much more costly than is commonly realized, even though they represent a sound public investment when justified. A modern signal can cost taxpayers between \$150,000 and \$300,000 to install, depending on the complexity of the intersection and the characteristics of the traffic using it.

### What are the effects of an unjustified traffic signal?

- Because of the widespread belief that traffic signals offer the solution to all intersection traffic-control and accident problems, a number of signals have been installed nationwide where no legitimate operational warrant exists. Traffic records clearly show that the attitudes and misunderstandings that sometimes lead to unjustified installations should be resisted. It is important that the selection and use of this traffic control device be preceded by a thorough study of traffic and roadway conditions and that the determination of the type of control and method of operation be based on the study data.
- Traffic signals should be used only where lesser forms of control have proven ineffective because signals almost always create more "overall intersection delay." In fact, minor movements may experience excessive delay, particularly if the signal is improperly timed. As a result, many drivers switch to less desirable alternate routes or to residential streets to avoid the added delay.



## Traffic Signal Warrant Study Summary

Location **Berry Trail** crossing **Belt Line Road**  
Minor street Major Street

From Texas Manual on uniform Traffic Control Devices	2011 edition	revision	2
<b>Warrant 1, Eight-Hour Vehicular Volume</b>	<b>Met</b>		
<b>Warrant 2, Four-Hour Vehicular Volume</b>	<b>Not Met</b>		
<b>Warrant 3, Peak Hour</b>	<b>Not Met</b>	<b>Not Applicable</b>	
<b>Warrant 4, Pedestrian Volume</b>	<b>Not Studied</b>		
<b>Warrant 5, School Crossing</b>	<b>Not Applicable</b>		
<b>Warrant 6, Coordinated Signal System</b>	<b>Not Met</b>		
<b>Warrant 7, Crash Experience</b>	<b>Not Met</b>		
<b>Warrant 8, Roadway Network</b>	<b>Not Met</b>		
<b>Warrant 9, Intersection Near a Grade Crossing</b>	<b>Not Applicable</b>		

**A traffic signal** is **recommended at this time**

Installation of Traffic Signals is regulated by State law.

State law requires that a Traffic Signal Warrant study be performed following the guidelines in the Texas Manual on Uniform Traffic Control Devices (TXMUTCD) to determine whether a location shall have a traffic signal. Only locations that meet minimum requirements specified in the TXMUTCD qualify for installation of traffic signals.

### Explanation Signal Warrants

#### Warrant 1, Eight-Hour Vehicular Volume

This warrant criteria is met when there is a large volume of intersecting traffic for at least 8 hours out of a day. This warrant is also met if the traffic volume on the major street is so heavy that the traffic on the minor street suffers excessive delay.

#### Warrant 2, Four-Hour Vehicular Volume

The Four-Hour Vehicular Volume signal warrant conditions are intended to be applied where the volume of intersecting traffic is the principal reason to consider installing a traffic control signal.

#### Warrant 3, Peak Hour

The Peak Hour signal warrant is intended for use at a location where traffic conditions are such that for a minimum of 1 hour of an average day, the minor-street traffic suffers undue delay when entering or crossing the major streets. This signal warrant shall be applied only in unusual cases, such as office complexes, manufacturing plants, industrial complexes, or high-occupancy vehicle facilities that attract or discharge large numbers of vehicles over a short period of time..

#### Warrant 4, Pedestrian Volume

The Pedestrian Volume signal warrant is intended for application where the traffic volume on a major street is so heavy that pedestrians experience excessive delay in crossing the major street.

#### Warrant 5, School Crossing

The School Crossing signal warrant is intended for application where the fact that school children cross the major street is the principal reason to consider installing a traffic control signal. This warrant checks to see if there are sufficient gaps in the traffic to allow school children to cross.

#### Warrant 6, Coordinated Signal System

Progressive movement in a coordinated signal system sometimes necessitates installing traffic control signals at intersections where they would not otherwise be needed in order to maintain proper platooning of vehicles.

#### Warrant 7, Crash Experience

Traffic signals can reduce some types of crashes, particularly right angle collisions. To meet this warrant at least 5 right angle have to have occurred within 1 year.

#### Warrant 8, Roadway Network

Installing a traffic control signal at some intersections might be justified to encourage concentration and organization of traffic flow on a roadway network. This warrant looks at a street's classification on an adopted master transportation plan. The City of Dallas has a Master Thoroughfare Plan.

#### Warrant 9, Intersection Near a Grade Crossing

The Intersection Near a Grade Crossing signal warrant is intended for use at a location where none of the conditions described in the other eight traffic signal warrants are met, but the proximity to the intersection of a grade crossing on an intersection approach controlled by a STOP or YIELD sign is the principal reason to consider installing a traffic control signal.

Signal Warrant Study  
 Vehicle Counts

Count Date	Day of Week	Pedestrian
<u>6/16/2017</u>	Friday	<u>Count Date</u>
		#####

Time Period	Major Street		Minor Street		Pedestrians crossing Major
	NB	SB	EB	WB	
12 - 1 AM	81	145	3	9	
1 - 2 AM	51	90	5	3	
2 - 3 AM	24	77	5	1	
3 - 4 AM	22	32	0	8	
4 - 5 AM	57	28	0	13	
5 - 6 AM	239	87	2	25	
6 - 7 AM	564	192	7	57	
7 - 8 AM	1062	375	9	82	
8 - 9 AM	1078	392	17	112	
9 - 10 AM	746	492	40	77	
10 - 11 AM	646	486	74	66	
11 A - 12 P	733	588	71	80	
12 - 1 PM	753	702	83	81	
1 - 2 PM	685	730	104	61	
2 - 3 PM	720	757	95	71	
3 - 4 PM	686	820	87	67	
4 - 5 PM	750	1038	86	82	
5 - 6 PM	741	1094	73	88	
6 - 7 PM	662	832	84	85	
7 - 8 PM	618	742	67	78	
8 - 9 PM	446	618	67	48	
9 - 10 PM	456	579	27	41	
10 - 11 PM	299	535	13	24	
11PM - 12AM	204	412	13	14	
<b>SubTotal</b>	12323	11843	1032	1273	



**Warrant 1 Eight Hour Volumes**

	Name	#lanes	Speed Type
Major Street	Belt Line Road	3	44 85th Percentile
Minor Street	Berry Trail	2	

Test 1	Condition A <b>or</b> Condition B, volumes 100%	<b>Not Met</b>	
Test 2	Condition A <b>and</b> Condition B, volumes 80%	<b>Not Met</b>	
Test 3	If speed > 40 mph, Condition A <b>or</b> B, volumes 70%	<b>Met</b>	<b>Applicable</b>
Test 4	If speed > 40 mph, Condition A <b>and</b> B, volumes 56%	<b>Not Met</b>	<b>Applicable</b>

Warrant 1 **Met**

Count Date	6/16/2017	Day of Week	Friday	Major street volume required	600	900	480	720	420	630	336	504
				Minor Street volume required	200	100	160	80	140	70	112	56

Time Period	Major Street Both Approaches	Minor Street Greater Volume of the Two Approaches	Percentage of Right Turns	Adjusted Minor Street Traffic	Condition A 100%		Condition B 100%		Condition A 80%		Condition B 80%		Condition A 70%		Condition B 70%		Condition A 56%		Condition B 56%	
12 - 1 AM	226	9	15%	8	0	0	0	0	0	0	0	0	0	0	0	0	0	0	0	
1 - 2 AM	141	5	15%	4	0	0	0	0	0	0	0	0	0	0	0	0	0	0	0	
2 - 3 AM	101	5	15%	4	0	0	0	0	0	0	0	0	0	0	0	0	0	0	0	
3 - 4 AM	54	8	15%	7	0	0	0	0	0	0	0	0	0	0	0	0	0	0	0	
4 - 5 AM	85	13	15%	11	0	0	0	0	0	0	0	0	0	0	0	0	0	0	0	
5 - 6 AM	326	25	15%	21	0	0	0	0	0	0	0	0	0	0	0	0	0	0	0	
6 - 7 AM	756	57	15%	48	0	0	0	0	0	0	0	0	0	0	0	0	0	0	0	
7 - 8 AM	1437	82	15%	70	0	0	0	0	0	0	0	1	0	1	0	1	0	1	1	
8 - 9 AM	1470	112	15%	95	0	0	0	1	0	0	1	0	1	0	1	0	1	0	1	
9 - 10 AM	1238	77	15%	65	0	0	0	0	0	0	0	0	0	0	0	0	0	0	1	
10 - 11 AM	1132	74	15%	63	0	0	0	0	0	0	0	0	0	0	0	0	0	0	1	
11 A - 12 P	1321	80	15%	68	0	0	0	0	0	0	0	0	0	0	0	0	0	0	1	
12 - 1 PM	1455	83	15%	71	0	0	0	0	0	0	0	1	0	1	0	1	0	1	1	
1 - 2 PM	1415	104	15%	88	0	0	0	0	1	0	1	0	1	0	1	0	1	0	1	
2 - 3 PM	1477	95	15%	81	0	0	0	0	1	0	1	0	1	0	1	0	1	0	1	
3 - 4 PM	1506	87	15%	74	0	0	0	0	0	0	0	1	0	1	0	1	0	1	1	
4 - 5 PM	1788	86	15%	73	0	0	0	0	0	0	0	1	0	1	0	1	0	1	1	
5 - 6 PM	1835	88	15%	75	0	0	0	0	0	0	0	1	0	1	0	1	0	1	1	
6 - 7 PM	1494	85	15%	72	0	0	0	0	0	0	0	1	0	1	0	1	0	1	1	
7 - 8 PM	1360	78	15%	66	0	0	0	0	0	0	0	0	0	0	0	0	0	0	1	
8 - 9 PM	1064	67	15%	57	0	0	0	0	0	0	0	0	0	0	0	0	0	0	1	
9 - 10 PM	1035	41	15%	35	0	0	0	0	0	0	0	0	0	0	0	0	0	0	0	
10 - 11 PM	834	24	15%	20	0	0	0	0	0	0	0	0	0	0	0	0	0	0	0	
11PM - 12AM	616	14	15%	12	0	0	0	0	0	0	0	0	0	0	0	0	0	0	0	

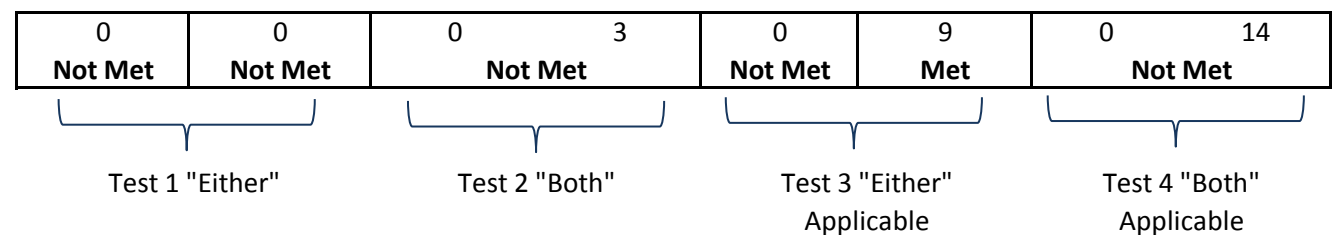

**Warrant 2 Four Hour Volumes**

	Name	#lanes	Speed Type
Major Street	Belt Line Road	3	44 85th Percentile
Minor Street	Berry Trail	2	

Volumes exceed minimum required for at least 4 hours **Not Met**  
 Figure 4C-2, Four Hour Warrant, Major Street 2 lanes or more, Minor Street 2 lanes or more, Speed > 40 mph

Count Date 6/16/2017 Day of Week Friday

Time Period	Minor Street		Adjusted Minor Street Traffic	Minor street volume required	Meets?
	Major Street Both Approaches	Greater Volume of the Two Approaches			
12 - 1 AM	226	9	15%	415	0
1 - 2 AM	141	5	15%	488	0
2 - 3 AM	101	5	15%	524	0
3 - 4 AM	54	8	15%	569	0
4 - 5 AM	85	13	15%	539	0
5 - 6 AM	326	25	15%	339	0
6 - 7 AM	756	57	15%	117	0
7 - 8 AM	1437	82	15%	80	0
8 - 9 AM	1470	112	15%	80	1
9 - 10 AM	1238	77	15%	80	0
10 - 11 AM	1132	74	15%	80	0
11 A - 12 P	1321	80	15%	80	0
12 - 1 PM	1455	83	15%	80	0
1 - 2 PM	1415	104	15%	80	1
2 - 3 PM	1477	95	15%	80	1
3 - 4 PM	1506	87	15%	80	0
4 - 5 PM	1788	86	15%	80	0
5 - 6 PM	1835	88	15%	80	0
6 - 7 PM	1494	85	15%	80	0
7 - 8 PM	1360	78	15%	80	0
8 - 9 PM	1064	67	15%	80	0
9 - 10 PM	1035	41	15%	80	0
10 - 11 PM	834	24	15%	96	0
11PM - 12AM	616	14	15%	170	0

3  
**Not Met** 4 required

Figure 4C-2, Four Hour Warrant, Major Street 2 lanes or more, Minor Street 2 lanes or more, Speed > 40 mph

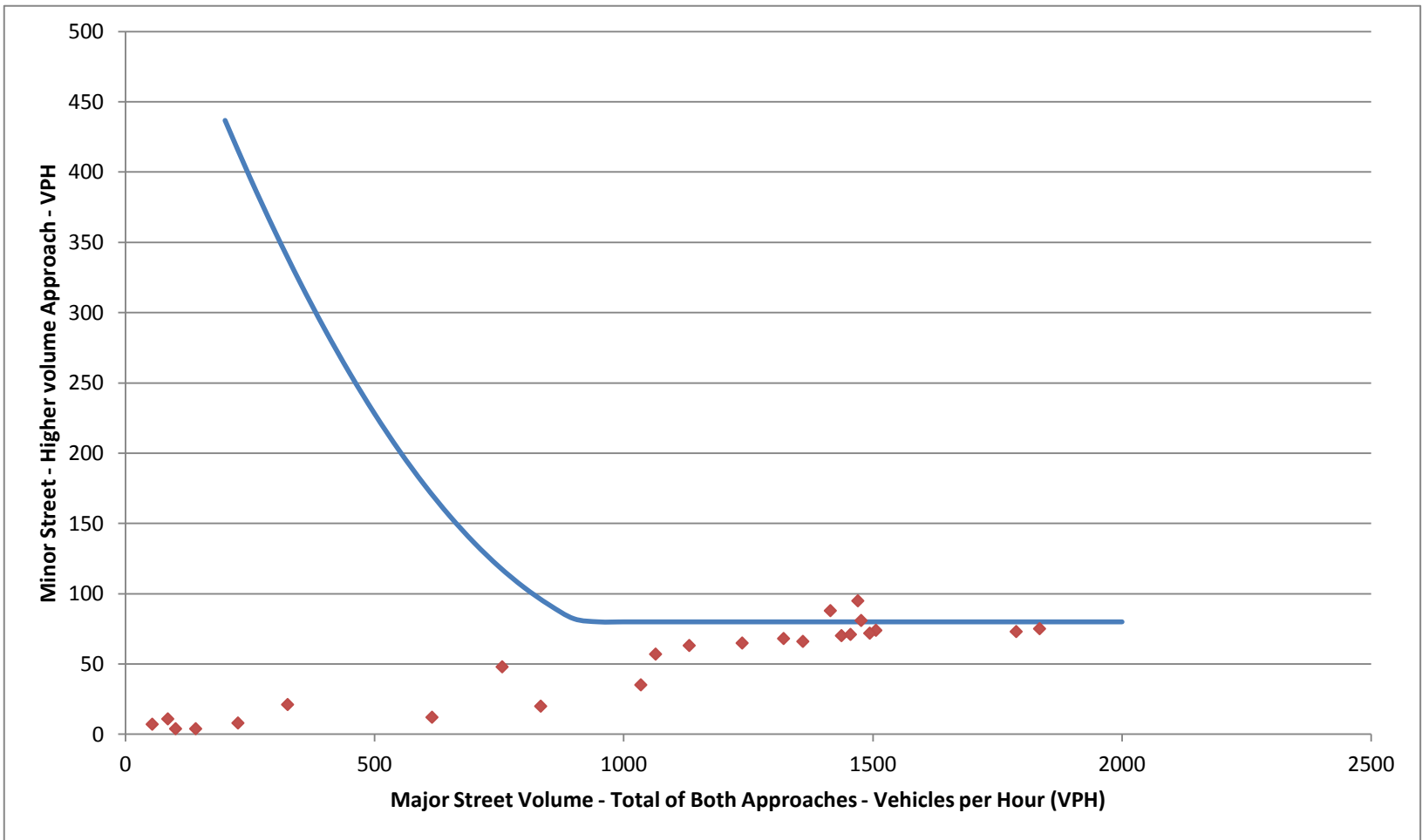

## Warrant 3 Peak Hour Volume

	Name	#lanes	Speed Type
Major Street	Belt Line Road	3	44 85th Percentile
Minor Street	Berry Trail	2	

Total Number of Intersection Approaches **4**

**NOTE:** This signal warrant shall be applied only in unusual cases, such as office complexes, manufacturing plants, industrial complexes, or high-occupancy vehicle facilities that attract or discharge large numbers of vehicles over a short time.

This warrant **Not Applicable**

### Peak Hour Warrant Summary

Delay Test **Not Met** Volume Test **Not Met** **Warrant 3 Not Met**

Either Delay Test or Volume Test must meet and warrant must be Applicable

**Delay Test** Not necessary because this warrant Not Applicable

Minor Street Delay		required	
AM	Total Peak Hour Delay	5.0	<b>Not Met</b>
Minor Street	Peak Hour Volume	150	<b>Not Met</b>
Total Volume entering intersection		800	<b>Not Met</b>
All 3 criteria must be met			<b>Not Met</b>

Note Delay data not collected because minimum volume thresholds not met

Minor Street Delay		required	
PM	Total Peak Hour Delay	5.0	<b>Not Met</b>
Minor Street	Peak Hour Volume	150	<b>Not Met</b>
Total Volume entering intersection		800	<b>Not Met</b>
All 3 criteria must be met			<b>Not Met</b>

Note Delay data not collected because minimum volume thresholds not met

Warrant 3 Peak Hour

Not Applicable - Do Not Print or include in package

Volume Test

Volumes exceed minimum required for at least 1 hour

**Not Met**

Figure 4C-4, Peak Hour Warrant, Major Street 2 lanes or more, Minor Street 2 lanes or more, Speed > 40 mph

Count Date

6/16/2017

Day of Week

Friday

Time Period	Major Street Both Approaches	Minor Street Greater Volume of the Two Approaches	Percentage of Right Turns	Adjusted Minor Street Traffic	Minor street volume required	Meets?
12 - 1 AM	226	9	15%	8	547	0
1 - 2 AM	141	5	15%	4	604	0
2 - 3 AM	101	5	15%	4	632	0
3 - 4 AM	54	8	15%	7	665	0
4 - 5 AM	85	13	15%	11	643	0
5 - 6 AM	326	25	15%	21	481	0
6 - 7 AM	756	57	15%	48	238	0
7 - 8 AM	1437	82	15%	70	100	0
8 - 9 AM	1470	112	15%	95	100	0
9 - 10 AM	1238	77	15%	65	100	0
10 - 11 AM	1132	74	15%	63	109	0
11 A - 12 P	1321	80	15%	68	100	0
12 - 1 PM	1455	83	15%	71	100	0
1 - 2 PM	1415	104	15%	88	100	0
2 - 3 PM	1477	95	15%	81	100	0
3 - 4 PM	1506	87	15%	74	100	0
4 - 5 PM	1788	86	15%	73	100	0
5 - 6 PM	1835	88	15%	75	100	0
6 - 7 PM	1494	85	15%	72	100	0
7 - 8 PM	1360	78	15%	66	100	0
8 - 9 PM	1064	67	15%	57	125	0
9 - 10 PM	1035	41	15%	35	133	0
10 - 11 PM	834	24	15%	20	204	0
11PM - 12AM	616	14	15%	12	308	0

0	1 required
Not Applicable	<b>Not Met</b>

Warrant 3 Peak Hour

Not Applicable - Do Not Print or include in package

Figure 4C-4, Peak Hour Warrant, Major Street 2 lanes or more, Minor Street 2 lanes or more, Speed > 40 mph



## Warrant 4 Pedestrian Volume

Major Street Name: Belt Line Road      Speed Type: 44 85th Percentile  
 Minor Street: Berry Trail

Pedestrian Study Performed? No      Not Studied  
 Pedestrian Warrant Summary      **Not Studied**

Four Hour Volume Test      **Not Met**  
 Peak Hour volume Test      **Not Met**

Count Date: Not Studied      Day of the Week: Not Studied

Time Period	Pedestrian Volume		Four Hour Test		Peak Hour Test	
	Major Street Both Approaches	Crossing Major Street	Ped Volume Required	Meets?	Ped Volume Required	Meets?
12 - 1 AM	226	0	326	0	502	0
1 - 2 AM	141	0	391	0	584	0
2 - 3 AM	101	0	424	0	625	0
3 - 4 AM	54	0	465	0	677	0
4 - 5 AM	85	0	438	0	642	0
5 - 6 AM	326	0	258	0	417	0
6 - 7 AM	756	0	78	0	170	0
7 - 8 AM	1437	0	75	0	93	0
8 - 9 AM	1470	0	75	0	93	0
9 - 10 AM	1238	0	75	0	93	0
10 - 11 AM	1132	0	75	0	93	0
11 A - 12 P	1321	0	75	0	93	0
12 - 1 PM	1455	0	75	0	93	0
1 - 2 PM	1415	0	75	0	93	0
2 - 3 PM	1477	0	75	0	93	0
3 - 4 PM	1506	0	75	0	93	0
4 - 5 PM	1788	0	75	0	93	0
5 - 6 PM	1835	0	75	0	93	0
6 - 7 PM	1494	0	75	0	93	0
7 - 8 PM	1360	0	75	0	93	0
8 - 9 PM	1064	0	75	0	93	0
9 - 10 PM	1035	0	75	0	93	0
10 - 11 PM	834	0	75	0	142	0
11PM - 12AM	616	0	117	0	231	0

4 required	0	1 required	0
	<b>Not Met</b>		<b>Not Met</b>

### Warrant 4 Pedestrian Warrant - Four Hour

Do Not Print or include in Packet

Figure 4C-6, Warrant 4, Pedestrian Four-Hour Volume, Speed > 35 mph

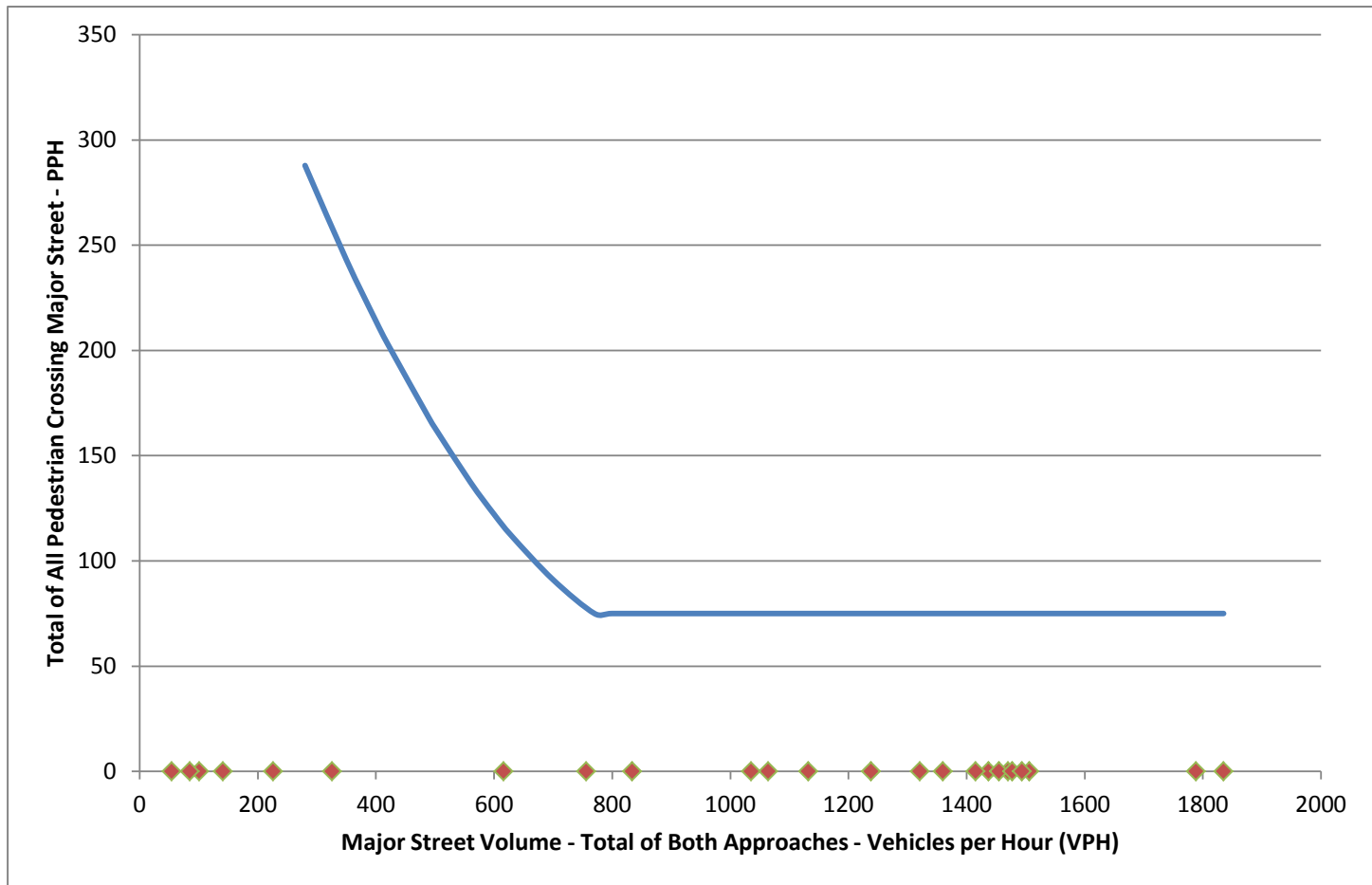

### Warrant 4 Pedestrian Warrant - Peak Hour

Figure 4C-8, Warrant 4, Pedestrian Peak-Hour Volume, Speed > 35 mph

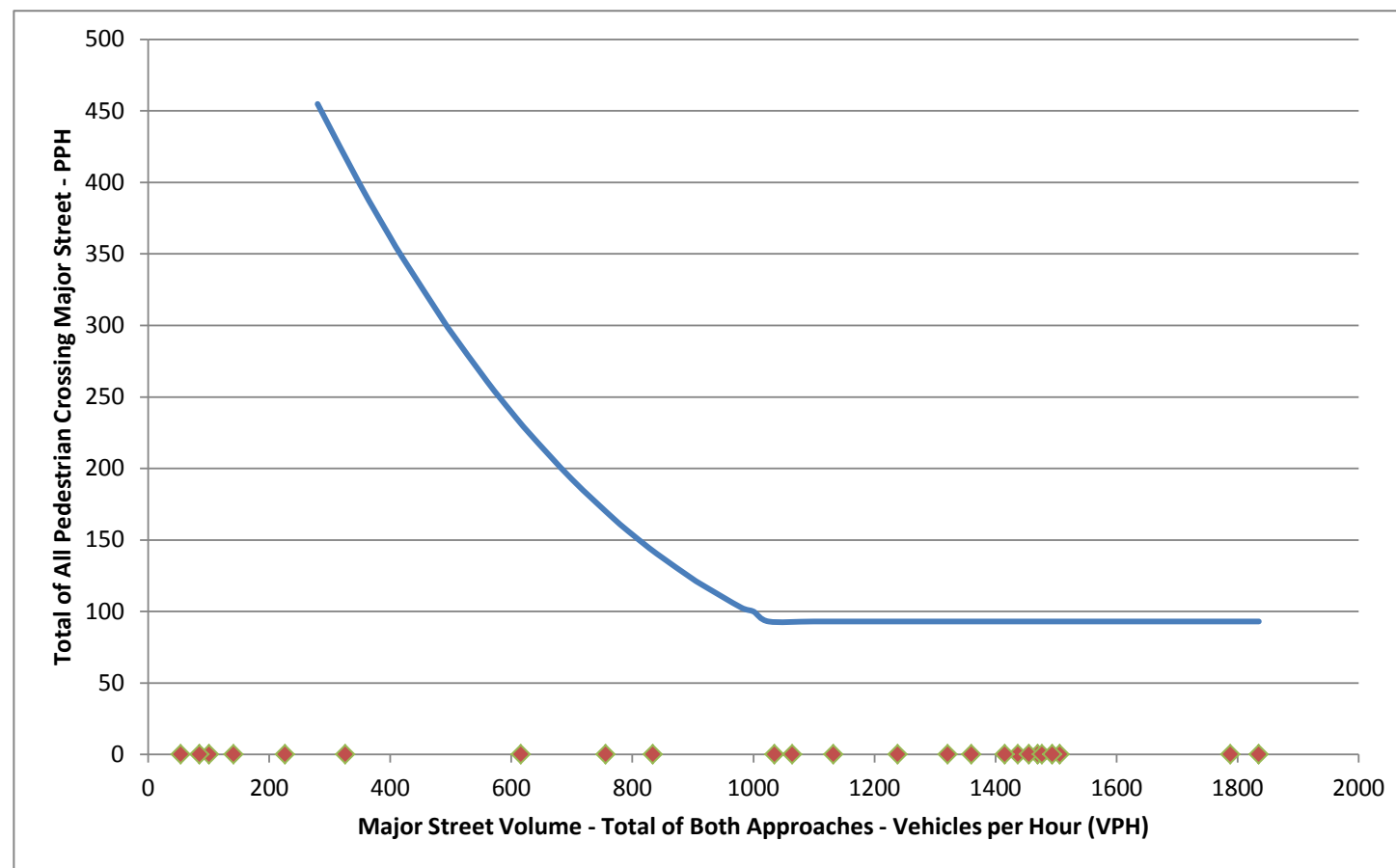



## Warrant 5 School Crossing Pedestrian Gap Study

Location Berry Trail crossing Belt Line Road  
Minor street Major Street

Is this intersection at a School Crossing? No  
 This Warrant is Not Applicable

Width of Crosswalk 0 ft Adequate Gap 5 s  
 Gap = (Width / 3.5 fps) + 5 sec

Is there a median refuge? N (Y/N)  
 If so, consider evaluating gaps separately

### School Crossing Warrant Summary Not Applicable

Distance to nearest traffic signal 1162 ft must be  $\geq 300$  ft 

Criteria
<b>Met</b>

#### Morning

time of first student 0:00 AM  
 time of last student 0:00 AM  
 number of minutes 0 = number of gaps required

number of adequate gaps 0

<b>Not Met</b>
----------------

  
 number of students 0 must be  $\geq 20$ 

<b>Not Met</b>
----------------

#### Afternoon

time of first student 0:00 PM  
 time of last student 0:00 PM  
 number of minutes 0 = number of gaps required

number of adequate gaps 0

<b>Not Met</b>
----------------

  
 number of students 0 must be  $\geq 20$ 

<b>Not Met</b>
----------------

#### Note:

Before a decision is made to install a traffic control signal, consideration shall be given to the implementation of other remedial measures, such as warning signs and flashers, school speed zones, school crossing guards, or a grade-separated crossing.





### Traffic Signal Warrant 6 - Coordinated Signal System

Location Berry Trail crossing Belt Line Road  
Minor street Major Street

Distance to nearest traffic signal 1162 ft should be ≥ 1000 ft **Met**

Are adjacent signals so far apart that adequate platooning is not provided? **No**

Coordinated Signal System Warrant **Not Met**

### Traffic Signal Warrant 7 - Crash Experience

No. of Right-Angle Accidents: **1**  
 No. of Left-Turn Accidents: **0**  
 No. of Other Accidents Potentially Correctible with Signal: **0**  
 Total Potentially Correctible: **1**

Requirement: 5 total potentially correctable within 12 month period  
 Volume - Either Warrant 1 Condition A 80% or Condition B 80% met **Not Met** } Both Required  
**Met**

Crash Experience Warrant **Not Met**

See attached full Crash History

### Traffic Signal Warrant 8 - Roadway Network

The need for a traffic control signal shall be considered if an engineering study finds that the common intersection of two or more major routes meets one or both of the following criteria:

- Yes A. The intersection has a total existing, or immediately projected, entering volume of at least 1,000 vehicles per hour during the peak hour of a typical weekday and has 5-year projected traffic volumes, based on an engineering study, that meet one or more of Warrants 1, 2, and 3 during an average weekday; or
- Yes B. The intersection has a total existing or immediately projected entering volume of at least 1,000 vehicles per hour for each of any 5 hours of a non-normal business day (Saturday or Sunday).

A major route as used in this signal warrant shall have at least one of the following characteristics:

Belt Line Road	Berry Trail	
Yes	No	A. It is part of the street or highway system that serves as the principal roadway network for through traffic flow.
No	No	B. It includes rural or suburban highways outside, entering, or traversing a city.
Yes	No	C. It appears as a major route on an official plan, such as a major street plan in an urban area traffic and transportation study.
No	No	D. It connects areas of principal traffic generation.
No	No	E. It has surface street freeway or expressway ramp terminals.

Is Belt Line Road a major route? **Yes** Street Classification: Major Arterial  
 Is Berry Trail a major route? **No** Street Classification: Residential/Commercial Drive

To meet Warrant, both streets must be major routes

Are both streets major routes? **No**

Roadway Network Warrant **Not Met**



**Department of Street Services - Transportation Division  
Accident Study Summary**

**Location:** Belt Line - Berry Trail

**Total Number of Accidents** 6

**Period of Study:** 1/1/2013  
to 6/15/2017

**Number of Accidents Potentially  
Corrected by a Traffic Signal** None

Date	Day of Week	Time	Description	Type of Accident	Officer's Opinion of Contributing Factors	Light Condition	Weather	Pavement Condition	Could Crash Be Prevented by a Traffic Signal
8/5/2013	Monday	6:12 PM	NW Hit SW	Side Swipe	HAD BEEN DRINKING	DAYLIGHT	CLEAR	DRY	No
9/18/2013	Wednesday	4:22 PM	SE Hit SE	Side Swipe	TURNED IMPROPERLY - WRONG LANE	DAYLIGHT	CLEAR	DRY	No
11/12/2014	Wednesday	6:00 PM	Unit 1 Side Swiped Unit 2	Not at Int	CHANGED LANE WHEN UNSAFE	DARK, LIGHTED	CLEAR	DRY	No
8/15/2015	Saturday	3:54 PM	EB Rear Ended EB	Not at Int	FOLLOWED TOO CLOSELY	DAYLIGHT	CLEAR	DRY	No
1/12/2016	Tuesday	12:41 PM	WB Hit SB	Right Angle	FAILED TO YIELD ROW - STOP SIGN	DAYLIGHT	CLEAR	DRY	<b>YES</b>
6/7/2017	Wednesday	8:29 AM	WB Hit SB	Right Angle	FAILED TO YIELD ROW - STOP SIGN	DAYLIGHT	CLEAR	DRY	<b>YES</b>
		--	--	--					
		--	--	--					
		--	--	--					
		--	--	--					
		--	--	--					

## Average Daily Traffic Volumes Quality Traffic Data, LLC

PROJECT NUMBER	2017204 - 009	GPS COORDINATES	N/A
ON STREET	Berry Tr (E/W)	START DATE	Monday, June 12, 2017
CROSS STREET	Beltline Rd (N/S)	VICINITY	Dallas, TX

	AM COUNTS					PM COUNTS					
	NB	SB	EB	WB		NB	SB	EB	WB		
00:00	26	40	0	2		12:00	151	146	18	12	
00:15	16	26	2	0		12:15	165	126	14	16	
00:30	10	18	1	2		12:30	143	159	18	17	
00:45	12	64	17	101	0 3 1 5 173	12:45	166	625	175	606	12 62 17 62 1355
01:00	6	16	0	3		13:00	170	154	22	11	
01:15	2	22	0	0		13:15	149	149	25	19	
01:30	3	10	0	1		13:30	145	162	21	22	
01:45	6	17	12	60	0 0 0 4 81	13:45	144	608	176	641	16 64 18 70 1403
02:00	2	12	1	1		14:00	131	172	24	11	
02:15	9	18	0	1		14:15	139	173	16	12	
02:30	5	14	0	0		14:30	141	146	14	15	
02:45	3	19	6	50	0 1 1 3 73	14:45	143	554	186	677	12 71 15 63 1355
03:00	4	12	0	1		15:00	159	165	18	23	
03:15	8	8	0	1		15:15	170	166	19	15	
03:30	7	7	0	0		15:30	171	293	19	27	
03:45	5	24	9	36	0 0 1 3 63	15:45	163	663	207	751	21 77 14 79 1570
04:00	5	4	0	1		16:00	163	227	20	28	
04:15	10	6	0	1		16:15	166	237	8	15	
04:30	17	6	0	2		16:30	155	237	17	17	
04:45	24	55	7	23	0 0 0 4 83	16:45	166	650	226	936	15 60 17 77 1723
05:00	37	10	0	2		17:00	149	267	16	11	
05:15	51	17	0	4		17:15	176	298	18	22	
05:30	82	16	1	10		17:30	180	289	19	19	
05:45	75	245	25	68	1 2 7 23 138	17:45	220	726	249	1103	8 61 24 76 1965
06:00	84	40	1	10		18:00	159	242	29	15	
06:15	131	47	0	5		18:15	151	246	18	11	
06:30	163	48	1	10		18:30	150	168	17	20	
06:45	201	579	50	185	2 4 18 43 811	18:45	138	588	179	855	16 80 12 58 1591
07:00	192	73	0	23		19:00	143	172	15	16	
07:15	250	88	1	25		19:15	122	176	21	17	
07:30	249	101	3	21		19:30	133	171	6	13	
07:45	298	989	101	363	6 10 24 93 1455	19:45	133	571	152	671	13 55 17 67 1320
08:00	274	73	2	30		20:00	81	139	11	10	
08:15	266	87	2	32		20:15	87	142	22	10	
08:30	273	91	2	26		20:30	107	140	6	13	
08:45	240	1053	93	344	8 14 26 114 1525	20:45	89	367	122	543	11 50 7 40 1000
09:00	190	85	2	34		21:00	75	134	3	6	
09:15	172	131	3	24		21:15	81	117	4	4	
09:30	176	107	3	26		21:30	70	106	8	3	
09:45	171	709	111	434	11 19 13 97 1259	21:45	67	293	97	454	3 18 3 16 781
10:00	137	108	2	19		22:00	53	92	1	4	
10:15	120	94	5	15		22:15	56	114	0	3	
10:30	122	128	10	17		22:30	47	89	2	2	
10:45	131	510	109	439	6 23 11 62 1034	22:45	38	194	109	404	1 4 4 13 615
11:00	141	116	14	16		23:00	38	91	4	5	
11:15	128	100	12	17		23:15	29	107	0	3	
11:30	145	140	10	19		23:30	28	61	9	5	
11:45	162	576	130	486	13 49 12 64 1175	23:45	19	114	47	309	2 15 2 15 453
<b>TOTALS:</b>	<b>4841</b>	<b>2589</b>	<b>125</b>	<b>515</b>	<b>8070</b>	<b>TOTALS:</b>	<b>5922</b>	<b>7950</b>	<b>637</b>	<b>622</b>	<b>15131</b>

	SPLIT	60.0%	32.1%	1.5%	6.4%	34.8%	SPLIT	39.1%	52.5%	4.2%	4.1%	65.2%
PEAK HOUR	07:45	11:45	11:45	08:15	07:45		17:15	17:00	13:15	15:15	17:15	
PH VOLUME	1111	561	63	118	1587		735	1103	86	64	1967	
PHF	0.93	0.88	0.88	0.87	0.92		0.90	0.93	0.86	0.75	0.96	

DAY'S TOTAL				
NB	SB	EB	WB	TOTAL
10763	10539	762	1137	23201



**QUALITY TRAFFIC DATA, LLC**

Phone: 887-852-4355 Fax: 877-877-3698 Info@QualityTrafficData.com

## Average Daily Traffic Volumes Quality Traffic Data, LLC

JOB NUMBER:	2017204 - 009	GPS COORDINATE:	N/A
ON STREET:	Berry Tr (E/W)	START DATE:	Tuesday, June 13, 2017
CROSS STREET:	Beltline Rd (N/S)	CITY:	Dallas, TX

	AM COUNTS								PM COUNTS										
	NB	SB	EB	WB					NB	SB	EB	WB							
00:00	17	43	1	3					12:00	163	163	14	15						
00:15	16	44	0	1					12:15	177	154	16	16						
00:30	13	27	1	3					12:30	153	159	23	18						
00:45	17	63	29	143	0	2	1	8	216	12:45	199	692	179	655	20	73	26	75	1495
01:00	9	19	1	0					13:00	169	194	16	24						
01:15	8	16	0	1					13:15	157	179	15	23						
01:30	10	9	0	2					13:30	155	164	18	18						
01:45	9	36	19	63	0	1	0	3	103	13:45	160	611	182	719	21	70	10	75	1505
02:00	10	16	0	0					14:00	157	169	14	20						
02:15	4	27	1	0					14:15	129	189	24	15						
02:30	7	6	0	0					14:30	150	168	18	22						
02:45	6	27	7	56	0	1	0	0	84	14:45	144	580	190	716	19	75	14	71	1442
03:00	2	5	0	0					15:00	140	208	18	13						
03:15	5	6	0	0					15:15	171	171	18	20						
03:30	8	10	0	2					15:30	137	212	17	20						
03:45	8	23	12	33	0	0	1	3	59	15:45	175	623	247	838	12	65	18	70	1596
04:00	11	5	0	1					16:00	149	212	16	24						
04:15	12	9	0	1					16:15	172	256	20	17						
04:30	18	9	0	0					16:30	152	263	10	17						
04:45	27	68	8	31	0	0	0	2	101	16:45	170	613	247	978	11	57	19	77	1755
05:00	32	12	0	1					17:00	169	285	20	20						
05:15	58	7	0	5					17:15	181	268	14	26						
05:30	75	28	1	8					17:30	178	365	13	18						
05:45	91	256	28	75	1	2	7	21	354	17:45	172	700	299	1117	20	67	26	90	1974
06:00	86	40	1	10					18:00	160	256	17	15						
06:15	130	55	1	9					18:15	147	232	21	23						
06:30	169	50	0	10					18:30	191	229	14	16						
06:45	207	592	60	205	7	9	22	51	857	18:45	155	653	174	691	7	59	16	70	1673
07:00	218	68	1	17					19:00	144	201	17	20						
07:15	276	103	3	27					19:15	157	174	7	13						
07:30	263	123	3	30					19:30	114	162	7	12						
07:45	287	1044	104	398	6	13	22	96	1551	19:45	107	522	149	686	4	36	14	59	1302
08:00	282	110	1	33					20:00	130	173	8	21						
08:15	277	108	2	36					20:15	100	181	10	9						
08:30	274	92	2	27					20:30	108	153	18	15						
08:45	241	1074	103	413	6	11	27	123	1621	20:45	117	455	137	647	17	53	9	54	1209
09:00	210	114	3	23					21:00	94	128	8	5						
09:15	180	98	4	23					21:15	87	156	12	5						
09:30	173	111	11	16					21:30	90	153	3	1						
09:45	190	753	104	427	18	36	18	80	1296	21:45	59	330	125	562	0	23	2	13	928
10:00	143	96	5	17					22:00	62	125	1	6						
10:15	122	101	10	26					22:15	65	114	5	4						
10:30	150	127	11	15					22:30	47	87	6	8						
10:45	147	562	106	430	8	34	14	72	1098	22:45	37	311	76	402	2	14	4	22	649
11:00	136	110	15	13					23:00	43	94	0	2						
11:15	174	145	11	10					23:15	35	66	0	1						
11:30	173	147	10	19					23:30	25	60	0	0						
11:45	153	636	183	585	12	48	22	64	1333	23:45	24	127	45	265	0	0	2	5	397
<b>TOTALS:</b>	<b>5134</b>	<b>2859</b>	<b>157</b>	<b>523</b>	<b>8673</b>				<b>TOTALS:</b>	<b>6177</b>	<b>8476</b>	<b>591</b>	<b>681</b>	<b>15925</b>					

	SPLIT	59.2%	33.0%	1.8%	6.0%	35.3%		SPLIT	38.8%	53.2%	3.7%	4.3%	64.7%
PEAK HOUR	07:45	11:45	11:45	08:00	07:30		PEAK HOUR	17:00	17:00	14:15	12:30	17:00	
PH VOLUME	1120	659	65	123	1687		PH VOLUME	700	1117	79	91	1974	
PHF	0.98	0.90	0.71	0.85	0.99		PHF	0.98	0.93	0.82	0.88	0.95	

DAY'S TOTAL					
NB	SB	EB	WB	TOTAL	
11311	11335	748	1204	24598	



**QUALITY TRAFFIC DATA, LLC**  
 Phone: 887-852-4355 Fax: 877-877-3698 Info@QualityTrafficData.com

## Average Daily Traffic Volumes Quality Traffic Data, LLC

QTD PROJECT #	2017204 - 009	SPR #/COORDINATOR	N/A
ON STREET	Berry Tr (EW)	START DATE	Wednesday, June 14, 2017
CROSS STREET	Beltline Rd (NS)	VIOSITY	Dallas, TX

	AM COUNTS				PM COUNTS									
	NB	SB	EB	WB	NB	SB	EB	WB						
00:00	23	47	0	1	12:00	169	167	10	16					
00:15	15	34	2	3	12:15	174	149	16	21					
00:30	11	25	1	1	12:30	152	142	21	12					
00:45	9	58	22	128	0	3	0	5	194					
01:00	8	29	0	1	12:45	180	675	182	640	8	55	15	64	1434
01:15	10	9	0	1	13:00	149	173	22	22					
01:30	7	12	0	0	13:15	138	177	10	18					
01:45	11	36	15	65	2	2	1	3	106					
02:00	7	15	0	0	13:30	161	146	23	9					
02:15	9	16	2	3	13:45	175	623	173	669	14	69	16	64	1425
02:30	3	6	0	0	14:00	144	181	20	17					
02:45	5	24	8	45	0	2	0	3	74					
03:00	4	4	0	1	14:15	160	155	14	22					
03:15	8	6	0	1	14:30	155	150	18	21					
03:30	8	4	0	0	14:45	167	626	188	674	15	67	23	83	1450
03:45	7	27	8	22	0	0	2	4	53					
04:00	7	4	1	1	15:00	149	212	16	20					
04:15	14	4	0	0	15:15	164	165	22	19					
04:30	26	9	0	1	15:30	176	221	10	19					
04:45	26	73	7	24	1	2	0	2	101					
05:00	37	11	0	4	15:45	189	677	219	817	19	67	19	77	1638
05:15	71	24	0	6	16:00	174	220	11	18					
05:30	76	22	2	6	16:15	160	257	20	22					
05:45	75	259	20	77	0	2	9	25	363					
06:00	105	42	1	10	16:30	193	283	23	18					
06:15	116	53	0	12	16:45	178	705	250	1010	22	76	10	65	1859
06:30	169	56	1	16	17:00	178	272	28	20					
06:45	212	602	58	209	6	8	21	59	878					
07:00	210	76	3	23	17:15	177	279	15	23					
07:15	271	94	1	23	17:30	195	261	22	21					
07:30	254	89	3	21	17:45	197	747	258	1070	17	62	28	92	1991
07:45	304	1039	103	362	3	10	22	89	1500					
08:00	271	82	5	30	18:00	201	257	21	26					
08:15	269	112	3	30	18:15	174	245	21	25					
08:30	242	93	3	30	18:30	173	223	21	26					
08:45	272	1054	96	383	4	15	36	126	1578					
09:00	226	103	4	15	18:45	160	708	199	924	8	71	15	92	1795
09:15	175	89	1	29	19:00	132	199	12	13					
09:30	207	111	8	18	19:15	146	179	12	17					
09:45	178	786	94	397	5	18	18	80	1281					
10:00	150	96	7	29	19:30	169	179	8	12					
10:15	129	120	7	14	19:45	128	575	171	728	14	46	14	56	1405
10:30	138	106	7	18	20:00	114	145	18	15					
10:45	144	561	119	441	4	15	36	126	1578					
11:00	156	133	18	14	20:15	104	168	10	7					
11:15	166	160	10	20	20:30	82	156	9	10					
11:30	140	144	15	12	20:45	96	346	148	617	3	40	13	45	1098
11:45	167	629	133	570	9	52	15	61	1312					
TOTALS:	5148	2723	149	532	8552	TOTALS:	6449	8548	615	703	16315			

SPLIT	60.2%	31.8%	1.7%	6.2%	34.4%	SPLIT	39.5%	52.4%	3.8%	4.3%	65.6%
PEAK HOUR	07:15	11:15	10:45	08:00	07:45	PEAK HOUR	17:15	16:30	16:15	17:45	17:15
PH VOLUME	1100	604	57	126	1602	PH VOLUME	770	1064	93	105	1998
PHF	0.90	0.90	0.79	0.88	0.93	PHF	0.97	0.96	0.83	0.94	0.99

DAY'S TOTAL				
NB	SB	EB	WB	TOTAL
11597	11271	764	1235	24867



**QUALITY TRAFFIC DATA, LLC**

Phone: 887-852-4355 Fax: 877-877-3698 Info@QualityTrafficData.com

## Average Daily Traffic Volumes Quality Traffic Data, LLC

SITE PROJECT #	2017204 - 009	GPS COORDINATES	N/A
ON STREET	Berry Tr (E/W)	START DATE	Thursday, June 15, 2017
CROSS STREETS	Beltline Rd (NS)	VICINITY	Dallas, TX

	AM COUNTS					PM COUNTS										
	NB	SB	EB	WB		NB	SB	EB	WB							
00:00	20	46	1	4		12:00	146	182	18	15						
00:15	19	35	1	0		12:15	146	166	20	24						
00:30	12	34	0	2		12:30	143	172	21	14						
00:45	9	60	35	150	0 2 1 7	219	12:45	177	612	174	694	20	79	21	74	1459
01:00	12	23	0	0		13:00	157	210	14	20						
01:15	10	21	0	0		13:15	191	178	18	20						
01:30	4	22	0	1		13:30	179	169	17	22						
01:45	5	31	24	90	0 0 0 1	122	13:45	161	689	200	257	22	71	23	85	1601
02:00	5	11	2	0		14:00	157	181	20	23						
02:15	4	19	0	1		14:15	159	202	21	15						
02:30	7	12	0	0		14:30	160	206	21	23						
02:45	5	21	10	52	0 2 1 2	77	14:45	169	645	186	775	16	79	15	76	1574
03:00	8	8	0	0		15:00	182	221	20	19						
03:15	3	9	6	0		15:15	174	218	21	13						
03:30	7	5	0	1		15:30	176	201	15	20						
03:45	6	24	5	27	0 6 1 2	59	15:45	204	736	313	853	27	83	19	71	1743
04:00	8	5	0	0		16:00	175	226	24	24						
04:15	12	9	0	0		16:15	193	274	20	25						
04:30	15	3	0	2		16:30	187	249	12	10						
04:45	23	58	15	32	0 0 3 5	95	16:45	187	747	246	995	13	69	11	70	1876
05:00	34	12	0	1		17:00	145	298	17	16						
05:15	59	17	0	4		17:15	181	286	19	24						
05:30	80	23	2	4		17:30	182	249	20	27						
05:45	91	264	29	81	1 3 9 18	366	17:45	190	698	303	1136	15	71	20	87	1992
06:00	96	40	1	13		18:00	186	257	9	31						
06:15	105	46	2	5		18:15	157	227	12	19						
06:30	188	65	0	18		18:30	155	223	12	24						
06:45	207	596	45	196	1 4 16 52	848	18:45	202	700	204	911	18	51	19	93	1755
07:00	240	78	4	24		19:00	148	234	14	12						
07:15	286	101	2	25		19:15	154	193	15	19						
07:30	281	107	2	17		19:30	146	160	11	14						
07:45	320	1127	85	371	8 16 28 94	1608	19:45	119	567	165	772	12	52	12	57	1448
08:00	324	76	3	32		20:00	123	166	21	13						
08:15	281	104	0	32		20:15	125	155	14	16						
08:30	269	109	8	24		20:30	101	148	9	13						
08:45	259	1133	100	389	9 20 25 113	1855	20:45	82	431	147	616	5	49	13	55	1151
09:00	223	116	4	26		21:00	97	126	11	10						
09:15	211	120	5	22		21:15	77	134	11	12						
09:30	213	130	13	17		21:30	90	126	4	4						
09:45	214	861	139	505	17 39 18 83	1488	21:45	75	339	131	517	4	30	6	32	918
10:00	145	112	11	16		22:00	73	163	3	11						
10:15	149	95	8	20		22:15	58	129	2	4						
10:30	164	120	10	21		22:30	80	141	3	3						
10:45	162	620	134	461	17 46 14 71	1198	22:45	57	268	93	526	0	8	7	25	827
11:00	156	147	13	11		23:00	50	76	1	6						
11:15	165	142	12	14		23:15	37	89	0	1						
11:30	168	132	17	20		23:30	30	58	1	2						
11:45	182	671	122	543	13 55 22 67	1336	23:45	28	145	49	322	2	4	3	12	433
<b>TOTALS:</b>	<b>5466</b>	<b>2897</b>	<b>193</b>	<b>515</b>	<b>9071</b>	<b>TOTALS:</b>	<b>6571</b>	<b>8824</b>	<b>645</b>	<b>737</b>	<b>16777</b>					

<b>SPLIT</b>	60.3%	31.9%	2.1%	5.7%	<b>35.1%</b>	<b>SPLIT</b>	39.2%	52.6%	3.8%	4.4%	<b>64.9%</b>
<b>PEAK HOUR</b>	07:15	11:45	11:45	07:45	<b>07:45</b>	<b>PEAK HOUR</b>	15:45	17:00	15:15	17:15	<b>17:15</b>
<b>PH VOLUME</b>	1211	642	72	116	<b>1703</b>	<b>PH VOLUME</b>	759	1136	67	102	<b>1999</b>
<b>PHF</b>	0.93	0.88	0.86	0.91	<b>0.97</b>	<b>PHF</b>	0.94	0.94	0.81	0.82	<b>0.95</b>

DAY'S TOTAL					
NB	SB	EB	WB	TOTAL	
12037	11721	838	1252	<b>25848</b>	



**QUALITY TRAFFIC DATA, LLC**

Phone: 887-852-4355 Fax: 877-877-3698 Info@QualityTrafficData.com

## Average Daily Traffic Volumes Quality Traffic Data, LLC

QTD PROJECT ID:	2017204 - 009	QTD COORDINATOR:	N/A
ON STREET:	Berry Tr (E/W)	START DATE:	Friday, June 16, 2017
CROSS STREET:	Beltline Rd (N/S)	LOCATION:	Dallas, TX

	AM COUNTS				PM COUNTS									
	NB	SB	EB	WB	NB	SB	EB	WB						
00:00	23	34	3	3	12:00	197	185	20	18					
00:15	18	40	0	0	12:15	198	164	23	17					
00:30	26	36	0	2	12:30	180	173	20	28					
00:45	14	81	35	145	0	3	4	9	238					
01:00	17	23	4	1	12:45	178	753	180	702	20	83	18	81	1619
01:15	13	24	1	1	13:00	144	163	16	9					
01:30	12	26	0	0	13:15	194	171	30	17					
01:45	9	51	17	90	0	5	1	3	149					
02:00	8	21	5	0	13:30	169	194	30	18					
02:15	7	25	0	0	13:45	178	685	182	730	28	104	17	61	1580
02:30	6	16	0	1	14:00	165	194	18	18					
02:45	3	24	15	77	0	5	0	1	107					
03:00	4	8	0	0	14:15	202	173	22	20					
03:15	4	7	0	3	14:30	166	194	31	15					
03:30	6	9	0	2	14:45	187	720	196	757	27	95	18	71	1643
03:45	8	22	8	32	0	0	3	8	62					
04:00	6	3	0	2	15:00	158	195	17	10					
04:15	13	7	0	3	15:15	165	192	22	20					
04:30	18	8	0	1	15:30	162	206	28	15					
04:45	20	57	10	28	0	0	7	13	98					
05:00	28	11	0	1	15:45	201	685	227	820	20	87	22	67	1660
05:15	53	24	0	7	16:00	201	352	14	24					
05:30	79	23	0	9	16:15	176	249	21	20					
05:45	79	239	29	87	2	2	8	25	353					
06:00	83	36	4	14	16:30	191	289	25	14					
06:15	123	44	1	9	16:45	182	750	248	1038	26	86	24	82	1956
06:30	149	49	0	15	17:00	175	293	13	19					
06:45	209	564	63	192	2	7	19	57	820					
07:00	215	78	2	19	17:15	205	270	20	23					
07:15	268	109	4	20	17:30	177	265	18	29					
07:30	277	90	2	22	17:45	184	741	266	1094	22	75	17	88	1996
07:45	302	1052	98	375	1	9	21	82	1578					
08:00	272	87	7	37	18:00	175	244	24	21					
08:15	276	94	3	19	18:15	152	221	20	23					
08:30	269	116	4	34	18:30	175	190	25	22					
08:45	261	1078	95	392	3	17	22	112	1599					
09:00	190	97	9	19	18:45	160	652	177	832	15	84	19	85	1663
09:15	179	134	7	19	19:00	150	202	19	13					
09:30	198	127	6	22	19:15	186	207	19	19					
09:45	179	746	134	482	18	40	17	77	1355					
10:00	163	110	11	18	19:30	146	156	18	24					
10:15	141	100	10	20	19:45	136	618	177	742	11	67	22	78	1505
10:30	168	154	37	14	20:00	106	160	21	13					
10:45	174	646	122	486	16	74	14	66	1272					
11:00	167	130	22	17	20:15	134	173	16	13					
11:15	179	162	19	25	20:30	106	153	16	14					
11:30	188	143	18	20	20:45	100	446	132	618	14	67	8	48	1179
11:45	199	733	153	588	12	71	18	80	1472					
TOTALS:	5303	2984	233	533	9053	TOTALS:	7020	8859	799	740	17418			

SPLIT	58.6%	33.0%	2.6%	5.9%	34.2%	SPLIT	40.3%	50.9%	4.6%	4.2%	65.8%
PEAK HOUR	07:30	11:45	10:30	08:00	07:45	PEAK HOUR	15:45	16:30	13:00	16:45	16:30
PH VOLUME	1127	675	94	112	1640	PH VOLUME	769	1100	104	95	2017
PHF	0.93	0.91	0.64	0.76	0.97	PHF	0.94	0.94	0.87	0.82	0.97

DAY'S TOTAL				
NB	SB	EB	WB	TOTAL
12323	11843	1032	1273	26471



**QUALITY TRAFFIC DATA, LLC**

Phone: 887-852-4355 Fax: 877-877-3698 Info@QualityTrafficData.com

## Average Daily Traffic Volumes Quality Traffic Data, LLC

CDD PROJECT #	2017204 - 009	GPS COORDINATES	N/A
ON STREET	Berry Tr (E/W)	START DATE	Saturday, June 17, 2017
CROSS STREET	Beitline Rd (N/S)	COUNTY	Dallas, TX

	AM COUNTS								PM COUNTS										
	NB	SB	EB	WB					NB	SB	EB	WB							
00:00	42	98	5	4					12:00	150	175	21	23						
00:15	35	81	1	4					12:15	173	200	22	22						
00:30	33	66	3	5					12:30	163	153	26	18						
00:45	26	136	59	304	7	16	1	14	470	12:45	167	678	178	706	11	80	24	87	1551
01:00	18	72	1	1					13:00	196	166	36	21						
01:15	16	64	2	1					13:15	210	217	50	17						
01:30	14	65	4	0					13:30	204	154	12	23						
01:45	12	60	59	260	3	10	2	4	334	13:45	300	810	185	722	22	120	30	81	1733
02:00	16	58	1	0					14:00	169	179	23	19						
02:15	7	51	0	2					14:15	156	186	21	16						
02:30	13	24	0	3					14:30	160	187	35	17						
02:45	17	53	25	158	0	1	2	7	219	14:45	169	654	199	751	22	101	15	63	1569
03:00	7	20	0	0					15:00	153	173	24	25						
03:15	7	22	0	2					15:15	165	216	26	20						
03:30	3	17	0	0					15:30	154	185	23	22						
03:45	10	27	11	70	0	0	0	2	99	15:45	170	642	201	775	31	104	10	77	1598
04:00	7	9	0	0					16:00	154	179	23	21						
04:15	7	7	0	0					16:15	141	179	30	13						
04:30	15	11	1	0					16:30	155	211	22	20						
04:45	16	45	8	35	0	1	1	1	82	16:45	196	646	178	747	29	104	18	72	1569
05:00	14	12	0	1					17:00	150	165	21	22						
05:15	16	11	1	6					17:15	151	179	23	26						
05:30	30	16	0	0					17:30	177	150	25	21						
05:45	35	95	20	59	1	2	1	8	164	17:45	135	622	158	652	28	97	18	87	1458
06:00	31	14	0	6					18:00	155	168	26	15						
06:15	56	24	0	3					18:15	141	151	25	13						
06:30	54	25	1	14					18:30	142	157	24	16						
06:45	60	201	24	87	0	1	6	29	318	18:45	183	621	171	647	15	90	19	63	1421
07:00	63	20	0	6					19:00	153	176	14	17						
07:15	54	37	0	11					19:15	129	148	20	10						
07:30	82	52	1	10					19:30	102	148	15	10						
07:45	89	288	54	163	3	4	12	39	494	19:45	125	509	141	643	14	63	20	57	1242
08:00	88	68	1	15					20:00	136	133	12	19						
08:15	104	59	1	11					20:15	124	139	15	13						
08:30	112	71	4	17					20:30	126	150	14	10						
08:45	155	459	96	294	5	11	19	62	826	20:45	102	488	127	549	6	47	10	52	1136
09:00	101	101	6	16					21:00	99	124	7	6						
09:15	133	103	10	32					21:15	106	141	7	4						
09:30	135	98	14	20					21:30	84	143	5	5						
09:45	136	505	111	413	13	43	25	93	1054	21:45	78	357	130	538	12	31	9	24	950
10:00	139	138	18	20					22:00	64	147	4	9						
10:15	133	129	16	19					22:15	94	128	3	6						
10:30	159	178	15	30					22:30	76	121	6	8						
10:45	148	579	149	594	16	65	16	85	1323	22:45	75	320	115	511	5	18	6	29	887
11:00	157	157	25	14					23:00	67	120	3	7						
11:15	182	132	20	12					23:15	56	110	0	2						
11:30	154	168	37	20					23:30	53	76	8	3						
11:45	197	690	167	624	25	107	20	66	1487	23:45	40	216	80	386	3	14	3	15	631
<b>TOTALS:</b>	<b>3138</b>	<b>3061</b>	<b>261</b>	<b>410</b>	<b>6870</b>				<b>TOTALS:</b>	<b>6572</b>	<b>7597</b>	<b>869</b>	<b>707</b>	<b>15745</b>					

	SPLIT	45.7%	44.6%	3.8%	6.0%	30.4%	SPLIT	41.7%	48.3%	5.5%	4.5%	69.6%
PEAK HOUR	11:45	11:30	11:00	09:15	11:45		PEAK HOUR	13:00	15:15	12:30	12:00	13:00
PH VOLUME	708	710	107	97	1580		PH VOLUME	810	781	123	87	1733
PHF	0.90	0.89	0.72	0.76	0.95		PHF	0.97	0.90	0.62	0.91	0.88

DAY'S TOTAL					
NB	SB	EB	WB	TOTAL	
9710	10658	1130	1117	22615	



**QUALITY TRAFFIC DATA, LLC**

Phone: 887-852-4355 Fax: 877-877-3698 Info@QualityTrafficData.com



## Average Daily Traffic Volumes Quality Traffic Data, LLC

PROJECT NO.	2017204 - 009	GPS COORDINATES	N/A
ON STREET	Berry Tr (E/W)	START DATE	Sunday, June 18, 2017
CROSS STREETS	Beltline Rd (N/S)	CITY	Dallas, TX

	AM COUNTS								PM COUNTS										
	NB	SB	EB	WB					NB	SB	EB	WB							
00:00	46	76	1	3					12:00	130	132	22	18						
00:15	46	60	0	1					12:15	171	145	22	18						
00:30	42	69	6	0					12:30	155	120	14	13						
00:45	34	168	58	263	0	7	0	4	442	12:45	165	629	166	572	13	71	21	70	1342
01:00	27	55	2	1					13:00	160	167	14	16						
01:15	26	44	1	1					13:15	134	138	6	24						
01:30	17	42	0	5					13:30	140	64	22	20						
01:45	20	90	51	192	0	3	2	9	294	13:45	144	578	160	529	30	72	25	65	1264
02:00	14	55	1	2					14:00	131	146	25	22						
02:15	15	65	6	3					14:15	139	168	21	16						
02:30	12	37	3	2					14:30	136	143	28	16						
02:45	18	59	34	191	0	10	1	8	268	14:45	168	574	137	594	14	89	12	66	1322
03:00	8	23	0	1					15:00	180	140	18	16						
03:15	6	17	0	0					15:15	151	141	14	9						
03:30	12	23	0	0					15:30	178	145	22	20						
03:45	5	31	26	89	0	0	0	1	121	15:45	158	667	157	583	21	75	10	55	1380
04:00	6	6	0	0					16:00	136	134	14	12						
04:15	9	9	0	2					16:15	113	141	23	13						
04:30	12	12	0	0					16:30	131	161	13	19						
04:45	8	35	6	33	0	0	1	3	71	16:45	122	502	111	547	13	63	12	56	1168
05:00	5	7	0	1					17:00	98	145	9	12						
05:15	7	12	0	2					17:15	131	124	17	17						
05:30	21	4	0	4					17:30	120	116	7	15						
05:45	15	48	8	31	0	0	2	9	88	17:45	121	478	153	538	17	50	19	63	1129
06:00	18	16	0	6					18:00	113	144	5	17						
06:15	16	17	0	1					18:15	133	155	11	10						
06:30	28	21	0	3					18:30	147	125	10	11						
06:45	43	105	19	73	0	0	4	14	192	18:45	124	517	133	557	8	34	7	45	1157
07:00	31	22	0	7					19:00	133	140	4	15						
07:15	41	34	0	2					19:15	107	99	4	10						
07:30	31	41	0	4					19:30	124	110	9	16						
07:45	47	150	33	130	1	1	10	23	304	19:45	92	456	96	445	6	23	10	51	975
08:00	28	29	1	10					20:00	104	117	4	6						
08:15	50	51	2	9					20:15	92	120	5	9						
08:30	71	51	2	8					20:30	86	103	6	11						
08:45	68	217	70	201	1	6	10	37	461	20:45	77	359	104	444	5	20	7	33	856
09:00	61	52	5	10					21:00	61	85	1	9						
09:15	56	67	3	6					21:15	69	112	2	4						
09:30	85	78	2	9					21:30	70	116	4	9						
09:45	107	309	79	275	3	13	15	41	639	21:45	56	256	112	425	3	10	3	25	716
10:00	92	100	8	8					22:00	60	85	2	10						
10:15	109	76	3	19					22:15	71	92	0	6						
10:30	118	73	5	17					22:30	50	78	1	3						
10:45	131	450	99	348	3	19	18	62	879	22:45	48	229	63	318	0	3	5	24	574
11:00	122	97	7	22					23:00	32	51	6	5						
11:15	122	119	10	14					23:15	33	68	2	3						
11:30	115	92	7	13					23:30	27	48	1	0						
11:45	129	488	108	416	10	34	21	70	1008	23:45	19	111	42	209	2	11	3	11	342
<b>TOTALS:</b>	<b>2150</b>	<b>2243</b>	<b>93</b>	<b>281</b>	<b>4767</b>				<b>TOTALS:</b>	<b>5356</b>	<b>5761</b>	<b>520</b>	<b>584</b>	<b>12221</b>					

	SPLIT	45.1%	47.1%	2.0%	5.9%	28.1%	SPLIT	43.8%	47.1%	4.3%	4.8%	71.9%
PEAK HOUR	11:45	11:45	11:45	10:15	11:45		PEAK HOUR	14:45	13:45	13:45	13:15	12:15
PH VOLUME	593	514	68	76	1245		PH VOLUME	677	617	104	91	1389
PHF	0.87	0.89	0.77	0.86	0.87		PHF	0.90	0.92	0.87	0.91	0.95

DAY'S TOTAL				
NB	SB	EB	WB	TOTAL
7506	8004	613	865	16988



**QUALITY TRAFFIC DATA, LLC**

Phone: 887-852-4355 Fax: 877-877-3698 Info@QualityTrafficData.com

# SPEED PROFILE

## Beltline Rd (N/S) - Berry Tr (E/W) (COMBINED)

OTD PROJECT #	2017204 - 010	GPS COORDINATES	0
ON STREET:	Beltline Rd (N/S)	START DATE:	Tuesday, June 13, 2017
CROSS STREETS	Berry Tr (E/W)	VICINITY:	Dallas, TX

Time	0 - < 15	15 - < 20	20 - < 25	25 - < 30	30 - < 35	35 - < 40	40 - < 45	45 - < 50	50 - < 55	55 - < 60	60 - < 65	65 - < 70	70 - < 200	Total
0:00	3	0	1	18	37	93	45	8	1	0	0	0	0	206
1:00	0	0	1	3	18	50	19	6	2	0	0	0	0	99
2:00	0	0	1	5	20	36	16	2	3	0	0	0	0	83
3:00	1	0	0	5	12	22	14	1	1	0	0	0	0	58
4:00	0	0	0	1	15	41	38	3	1	0	0	0	0	99
5:00	0	1	0	8	29	124	118	45	4	1	1	0	0	331
6:00	3	1	1	9	49	325	283	101	20	4	1	0	0	797
7:00	2	4	6	15	154	588	475	158	36	3	1	0	0	1442
8:00	1	5	4	12	140	638	492	167	21	7	0	0	0	1487
9:00	0	0	3	24	163	485	416	98	10	2	0	1	0	1180
10:00	0	2	1	39	195	398	270	73	12	2	0	0	0	992
11:00	1	2	8	29	215	582	320	66	15	1	2	0	0	1221
12:00	1	1	20	50	298	542	348	74	10	3	0	0	0	1347
13:00	4	2	7	57	292	633	274	77	10	2	1	0	1	1360
14:00	4	4	8	51	257	566	311	84	7	2	1	1	0	1296
15:00	3	3	6	45	284	757	238	105	16	4	2	0	0	1461
16:00	5	7	10	57	348	771	305	95	19	4	0	0	0	1621
17:00	2	4	17	57	430	855	331	98	22	1	0	0	0	1817
18:00	3	2	8	43	361	700	331	74	19	5	0	0	0	1544
19:00	2	4	0	35	240	568	285	78	18	0	0	0	0	1208
20:00	0	1	7	36	229	531	251	40	5	1	1	0	0	1102
21:00	0	1	6	28	193	484	163	31	5	1	0	0	0	892
22:00	1	3	3	21	143	305	104	25	3	4	1	0	0	613
23:00	0	0	3	17	98	175	85	14	1	1	0	0	0	382
<b>Total</b>	<b>36</b>	<b>47</b>	<b>119</b>	<b>685</b>	<b>4218</b>	<b>10209</b>	<b>5510</b>	<b>1521</b>	<b>259</b>	<b>48</b>	<b>11</b>	<b>2</b>	<b>1</b>	<b>22646</b>
% of Total	0%	0%	1%	3%	19%	45%	24%	7%	1%	0%	0%	0%	0%	

PERCENTILE SPEEDS:	10%	15%	50%	85%	90%
	30.7 mph	32.0 mph	37.1 mph	42.6 mph	43.6 mph

SPEED EXCEEDED:	15 MPH	25 MPH	35 MPH	45 MPH	55 MPH	65 MPH
	99.8%	99.1%	77.5%	8.1%	0.3%	0.0%
	22610	22444	17561	1842	62	3

10 MPH PACE:	SPEED	NUMBER IN PACE	% IN PACE
	35 - 45 MPH	15719	69.4%



QUALITY TRAFFIC DATA, LLC

Phone: 877-852-4355 Fax: 877-877-3698 Info@QualityTrafficData.com

SIGHT DISTANCE FIELD ASSESSMENT FORM MINOR STREET MOVEMENTS

LOCATION: BeltLine - Berry Trail

DATE: 5-28-15

COMPLETED BY: M. Potter

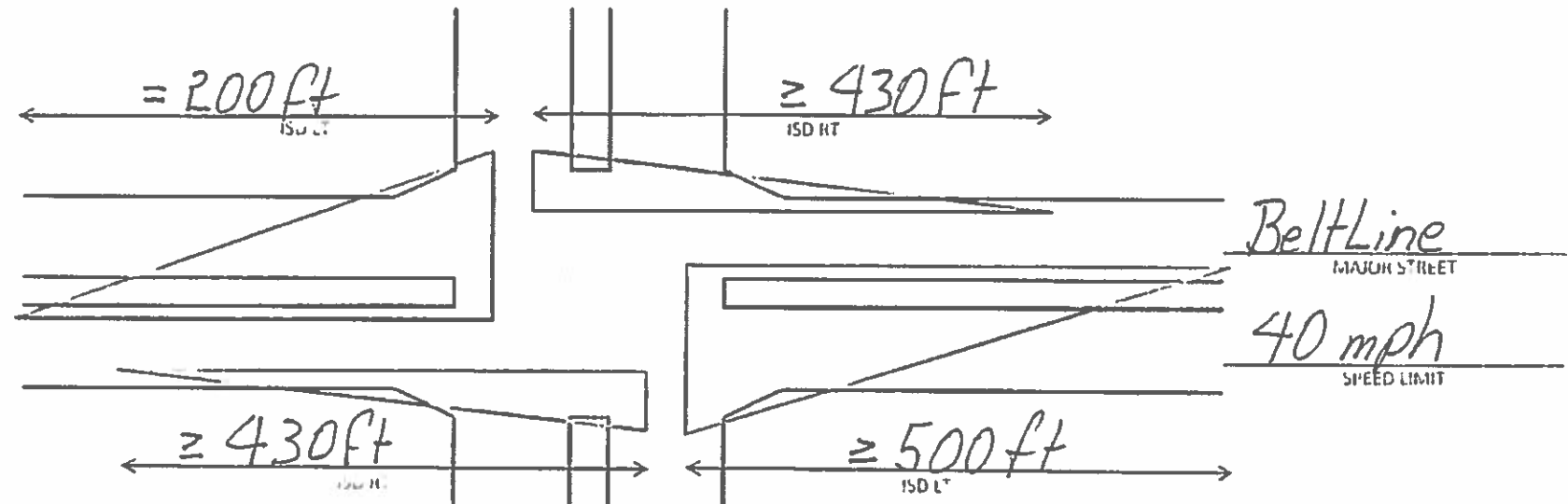
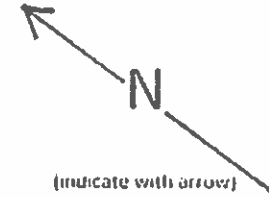

SBLT - Sight distance issue - Trees in median on BeltLine.

Notes:

- 1. Use this form for to check for stop control for permissive movements from the minor street
- 2. vehicle target height = 4.5 feet
- 3. eye height = 5.5 feet

Berry Trail  
MINOR STREET  
30 mph  
SPEED LIMIT

SPEED (MAJOR)	LEFT TURN OR THROUGH FROM STOP	RIGHT TURN FROM STOP
MPH	FT	FT
30	335	296
35	390	335
40	445	385
45	500	430
50	555	480

Ref. AASHTO Green Book, 2004 ed., Pp. 661, 664

**Excerpts from the Halff TerraCap TIA**

# TRAFFIC IMPACT ANALYSIS

## Terracap Mixed-Use Redevelopment Preston Road Dallas, Texas



May 11, 2022

 , PE 05/11/2022  
Signature of Registrant Date  
Halff Associates, Inc. – TBPELS Engineering Firm #312

Prepared for  
TerraCap Management Inc.



1201 North Bowser Road  
Richardson, Texas 75081

*Firm Registration No. 312*

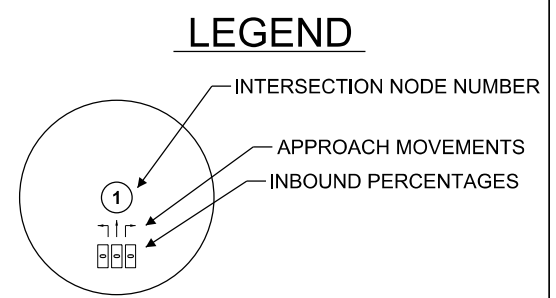
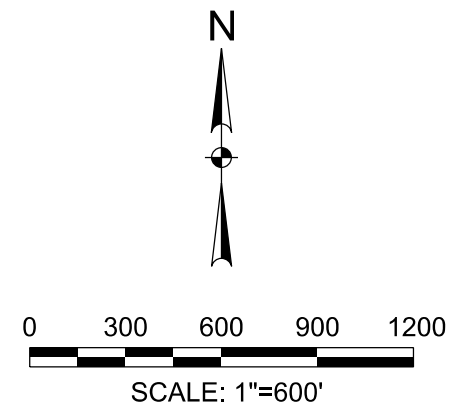
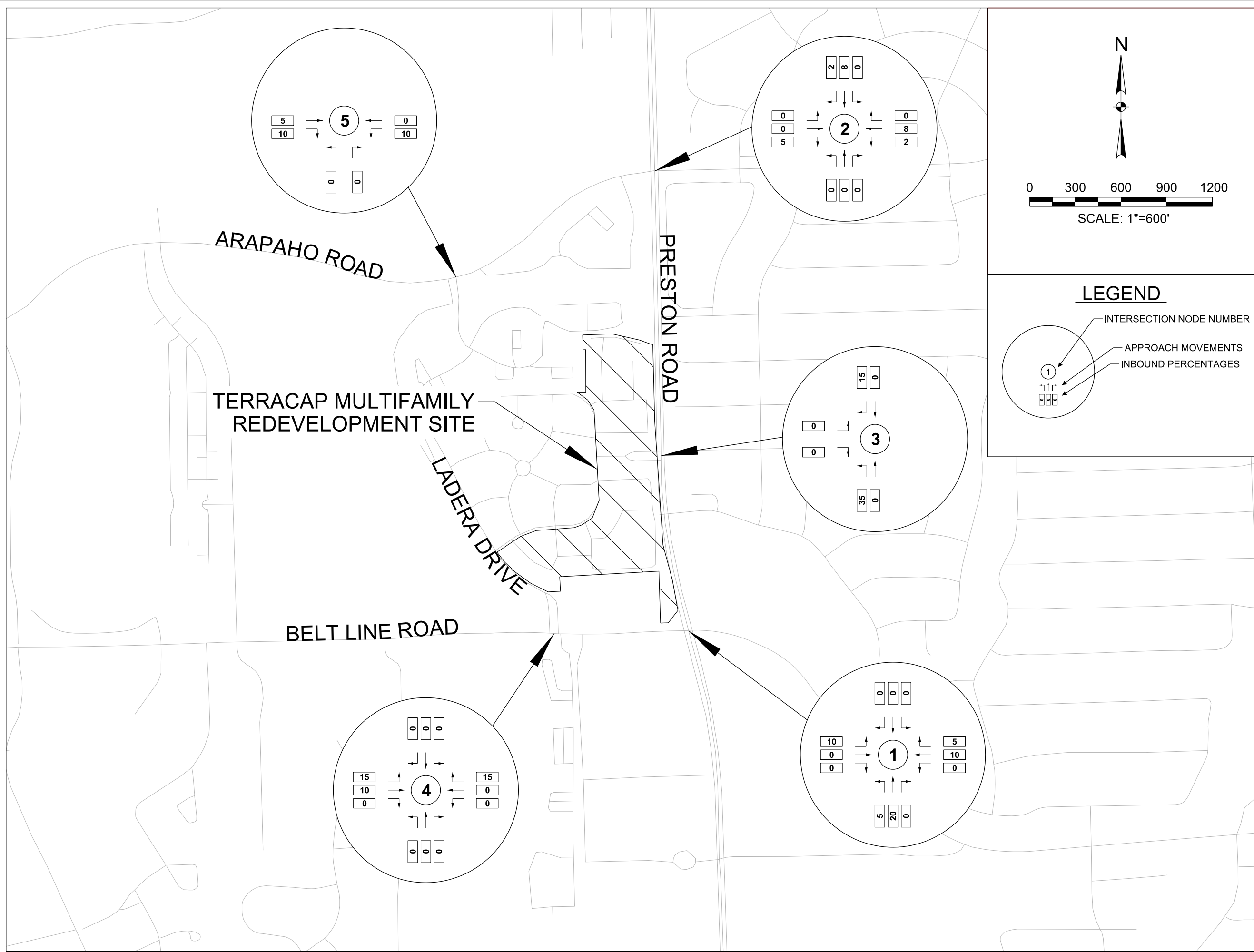

**TERRACAP MULTI-FAMILY REDEVELOPMENT**  
DALLAS, TEXAS

Project No.:	36071
Issued:	7/23/2021
Drawn By:	CM
Checked By:	SM
Scale:	1" = 600'
<b>Sheet Title</b> INBOUND TRIP DISTRIBUTION PERCENTAGES - TERRACAP MULTI-FAMILY REDEVELOPMENT	
<b>FIGURE 8</b> Sheet Number	

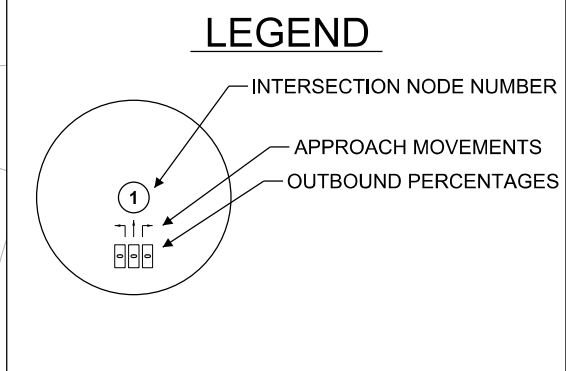
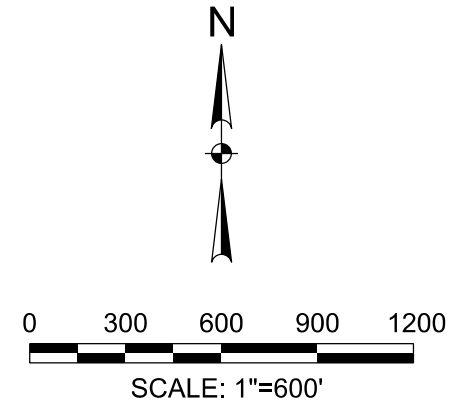
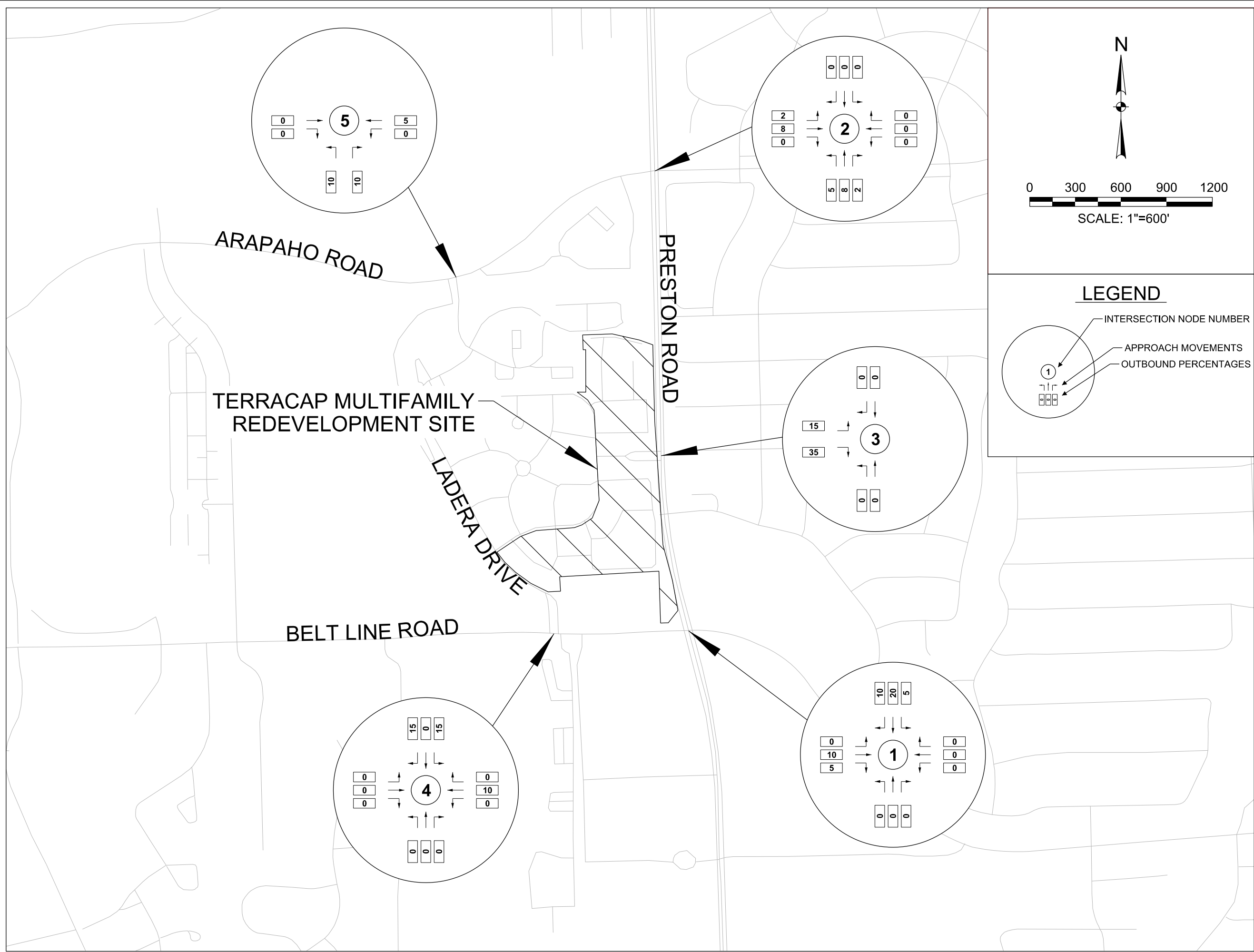

1201 NORTH BOWSER ROAD  
RICHARDSON, TEXAS 75081-2275  
TEL (214) 346-6200  
FAX (214) 799-0995  
TBPE FIRM # F-312

**TERRACAP MULTI-FAMILY REDEVELOPMENT**  
DALLAS, TEXAS

Project No.:	36071
Issued:	7/23/2021
Drawn By:	CM
Checked By:	SM
Scale:	1" = 600'
<b>Sheet Title</b> OUTBOUND TRIP DISTRIBUTION PERCENTAGES - TERRACAP MULTI-FAMILY REDEVELOPMENT	
<b>FIGURE 9</b> Sheet Number	

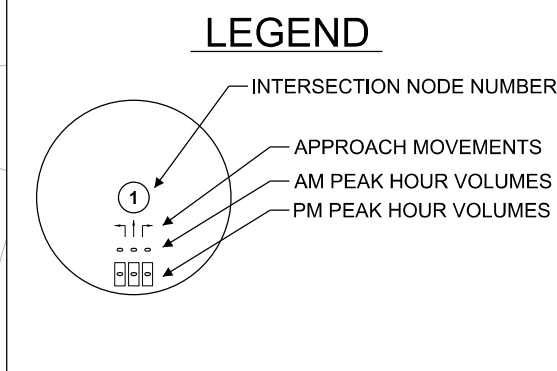
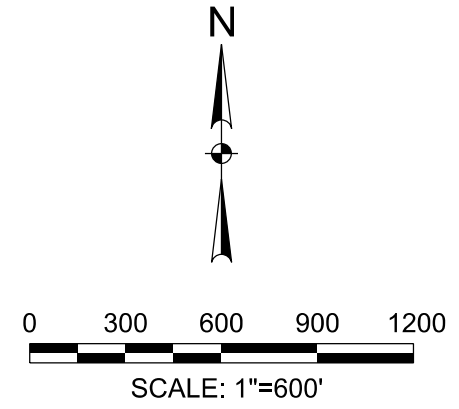
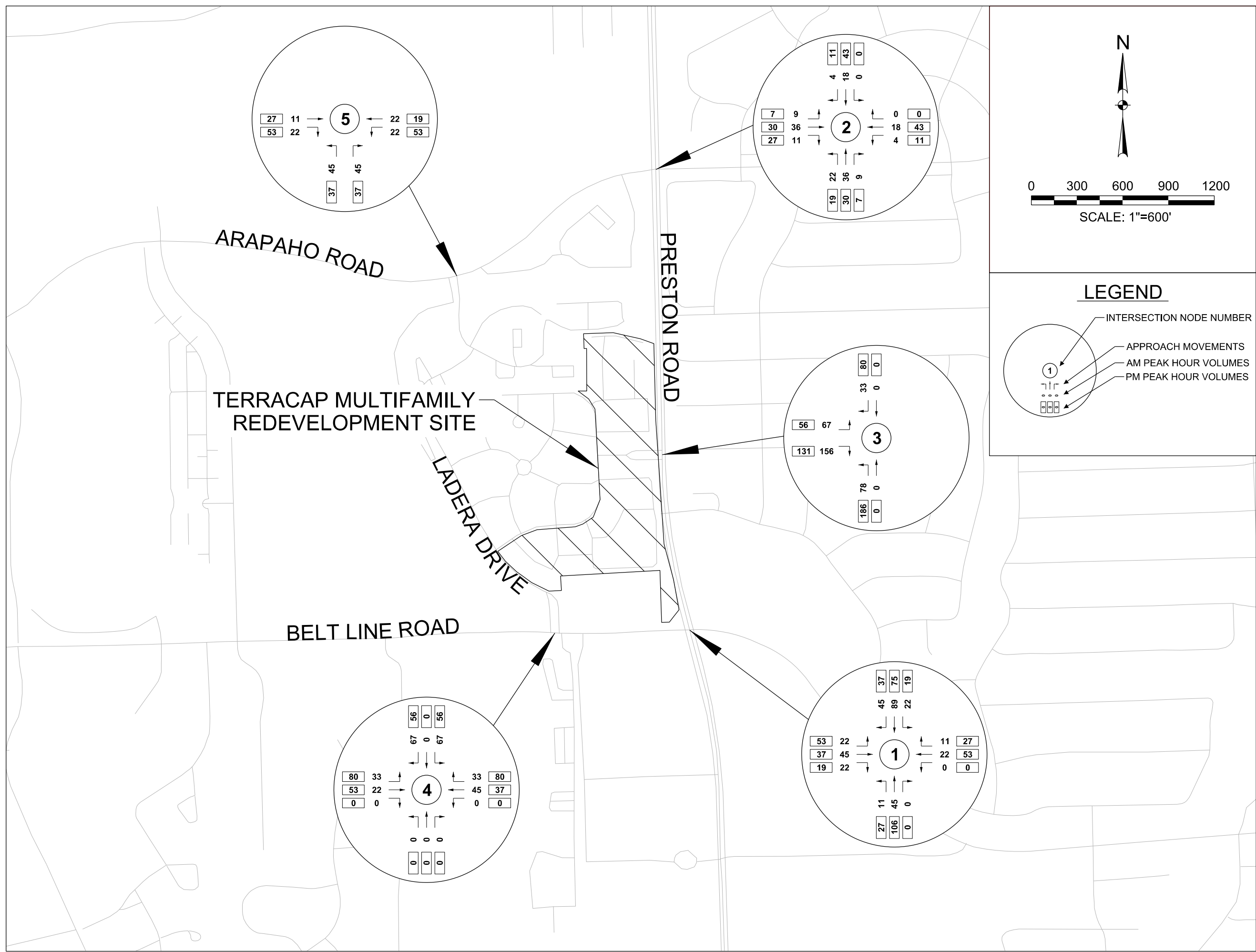

**TERRACAP MULTI-FAMILY REDEVELOPMENT**  
DALLAS, TEXAS

Project No.:	36071
Issued:	7/23/2021
Drawn By:	CM
Checked By:	SM
Scale:	1" = 600'
Sheet Title	NET DEVELOPMENT TRIPS - TERRACAP MULTI-FAMILY DEVELOPMENT

**FIGURE 10**  
Sheet Number



## VI. SITE TRAFFIC CHARACTERISTICS

As mentioned in Section III.C., the existing development is composed of low-rise multi-family residential buildings. A density study for the redevelopment proposes mid-rise and high-rise buildings to be utilized for the following uses: multi-family, restaurant, and retail use. As mentioned in Section I, an estimated construction timeline for the redevelopment calls for the project to be completed in five 2-year phases starting in the year 2023. For purposes of this study, Halff assumed the “Build Out” and “Horizon Year” analysis scenarios to be the years 2033 and 2038, respectively. At this time, the overall development plan, including land uses, densities, and construction phasing, is conceptual and has not been finalized. As specific development phasing plans have not yet been developed for the project, Halff only evaluated the Build Out (2033) and Horizon Year (2038) analysis scenarios.

Trips were generated for the existing development and the proposed Terracap mixed-use redevelopment for the Build Out (2033) and Horizon Year (2038) analysis scenarios. Trips were generated using the historical trip generation data published by the Institute of Transportation Engineers’ *Trip Generation Manual, 10<sup>th</sup> Edition*. Trips were generated for the typical weekday AM and PM peak hours and for the typical 24-hour weekday. **Table 2** details the land use, density, and trip generation calculations for the existing development and proposed redevelopment, respectively. The final row displays the net difference in trips between the existing development and the proposed redevelopment.

**Table 2 - Estimated Site-Generated One-Way Trips – Existing & Build Out Scenario**

Scenario	Land Use (Density) [ITE Code]	AM Peak Hour of Adjacent Street Traffic			PM Peak Hour of Adjacent Street Traffic			24-Hour Weekday
		In	Out	Total	In	Out	Total	Total
<b>Existing (2019)</b>	Multifamily Housing (Low-Rise) (353 dwelling units) [220]	36	122	158	114	67	181	2,628
<b>Build Out (2033) / Horizon Year (2038)</b>	Multifamily Housing (Mid-Rise) (912 dwelling units) [221]	85	243	328	245	156	401	4,969
	Multifamily Housing (High-Rise) (1,120 dwelling units) [222]	78	248	326	237	152	389	4,984
	Shopping Center (16,000 Sq. Ft. GLA) [820]	9	6	15	67	73	140	1,729
	High Turnover (Sit-Down) Restaurant (16,000 Sq. Ft. GLA) [932]	87	72	159	97	59	156	1,795
	<b>Total</b>	<b>259</b>	<b>569</b>	<b>828</b>	<b>646</b>	<b>440</b>	<b>1086</b>	<b>13,477</b>
<b>Net Difference</b>	<b>-</b>	<b>223</b>	<b>447</b>	<b>670</b>	<b>532</b>	<b>373</b>	<b>905</b>	<b>10,849</b>

Because of the small amount of non-residential land uses proposed for the site, a total of 32,000 square feet of retail and restaurant uses, Halff did not apply any trip reduction factors to the proposed redevelopment, such as pass-by trips or internal trips. This methodology evaluates the potential impacts of the redevelopment at a worse-case scenario.



## **CRIS Crash Data for the Intersection of Belt Line Road and Preston Road**

← INTRODUCTION & INSTRUCTIONS →

- County: All
- MPO: All
- City: DALLAS
- Year: All
- Crash Severity: All
- Crash Type: All
- Primary Contributing Factor: All
- Road User Type: All
- Vehicle Type: All
- Age Group: All

Navigate to a different page by selecting the page's tab.

Use the arrows to navigate to the previous page or the next page

Filter the data displayed by selecting from the drop-down menus. Selections are saved while navigating to other pages.

Click to reset all drop-down menus.

**Introduction:**  
This dashboard was developed for Kimley-Horn & Associates staff to use to assist clients with analyzing crash data within Texas.

This dashboard displays crash data for crashes occurring within the entire state of Texas. Data shown on this dashboard was obtained using TxDOT's Crash Records Information System (CRIS). The data has not been cleaned or edited and falls back on the accuracy of the CRIS database itself.

**Key Definitions:**  
**Crash** - An event involving at least one unit that produces injury and/or property damage.  
**Unit** - An entity involved in a crash, such as a vehicle, bicycle, or pedestrian.

**Collision Event** - The first injury or damage-producing event.  
**Primary Contributing Factor** - The first factor for the vehicle which the officer felt contributed to the crash.  
**Crash Severity** - The most severe injury suffered by any one person involved in the crash.  
**Crash Type** - The manner in which the unit(s) were moving prior to the first harmful event.  
**Intersection Relationship** - Specifies whether a crash occurred at an intersection, not at an intersection, or if the presence of an intersection contributed to the crash.  
**Restraint Status** - Specifies whether a person involved in a crash was wearing a restraint (seat belt) at the time of the crash.  
**Road Class** - The functional classification group of the priority road the motor vehicle(s) was traveling on before the the crash occurred.  
**Traffic Control** - Type of traffic control at the scene of the crash, such as signal, stop sign, etc.  
**Vehicle Body Style** - The body style of the vehicle involved in the crash, such as 4-door passenger car, pickup, etc.

**Example Graphic**

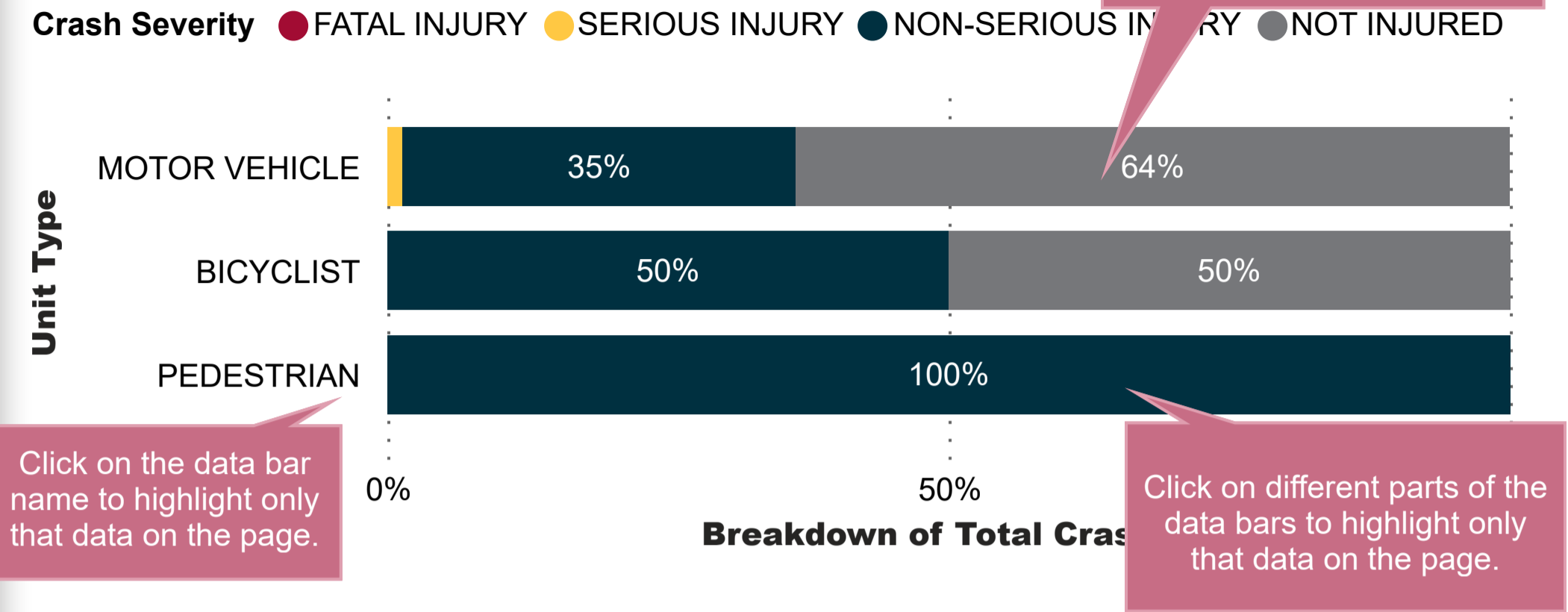

Click on the data bar name to highlight only that data on the page.

Hover over different parts of the data bars to see more information.

Click on different parts of the data bars to highlight only that data on the page.

Hover over a chart to reveal this menu. The single down arrow turns on the drill-down function. When the drill-down function is on, you can select a data bar name and the next level of data in the hierarchy will be revealed for that data bar. To return to the previous level of the hierarchy, select the up arrow. The double down arrow allows you to go to the next level of hierarchy. The branching down arrow expands all data bars to the next level of hierarchy, showing both labels for both levels.

**Example Graphic**

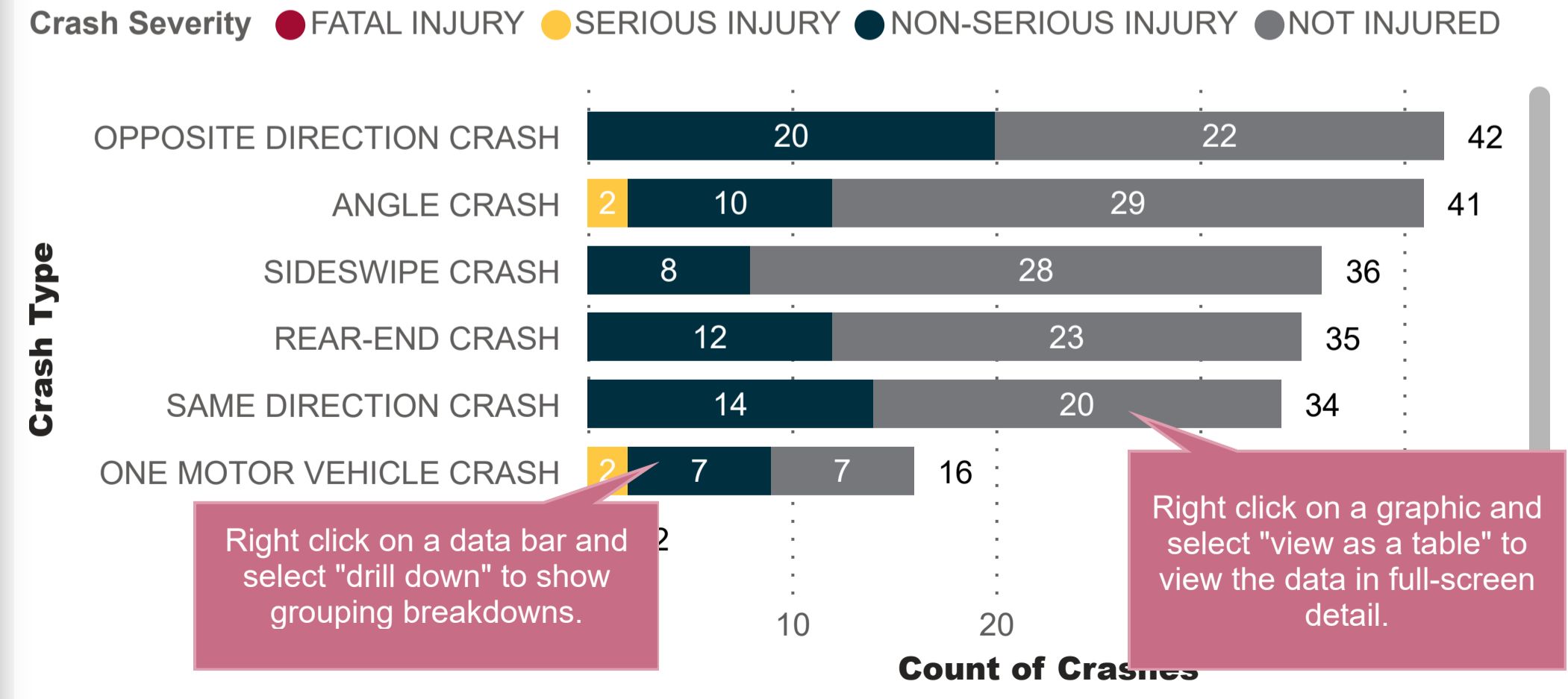

Right click on a data bar and select "drill down" to show grouping breakdowns.

Right click on a graphic and select "view as a table" to view the data in full-screen detail.

Clear all filters



**OVERVIEW**

County: All

MPO: All

City: DALLAS

Year: All

Crash Severity: All

Crash Type: All

Primary Contributing Factor: All

Road User Type: All

Vehicle Type: All

Age Group: All

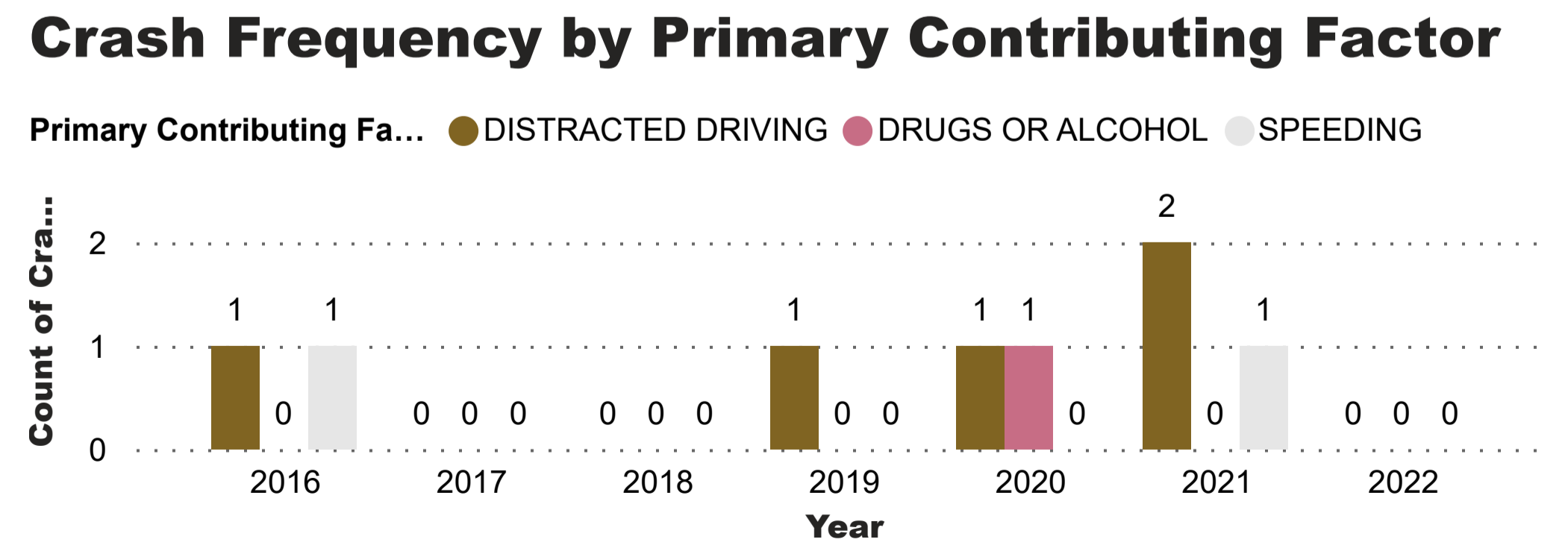
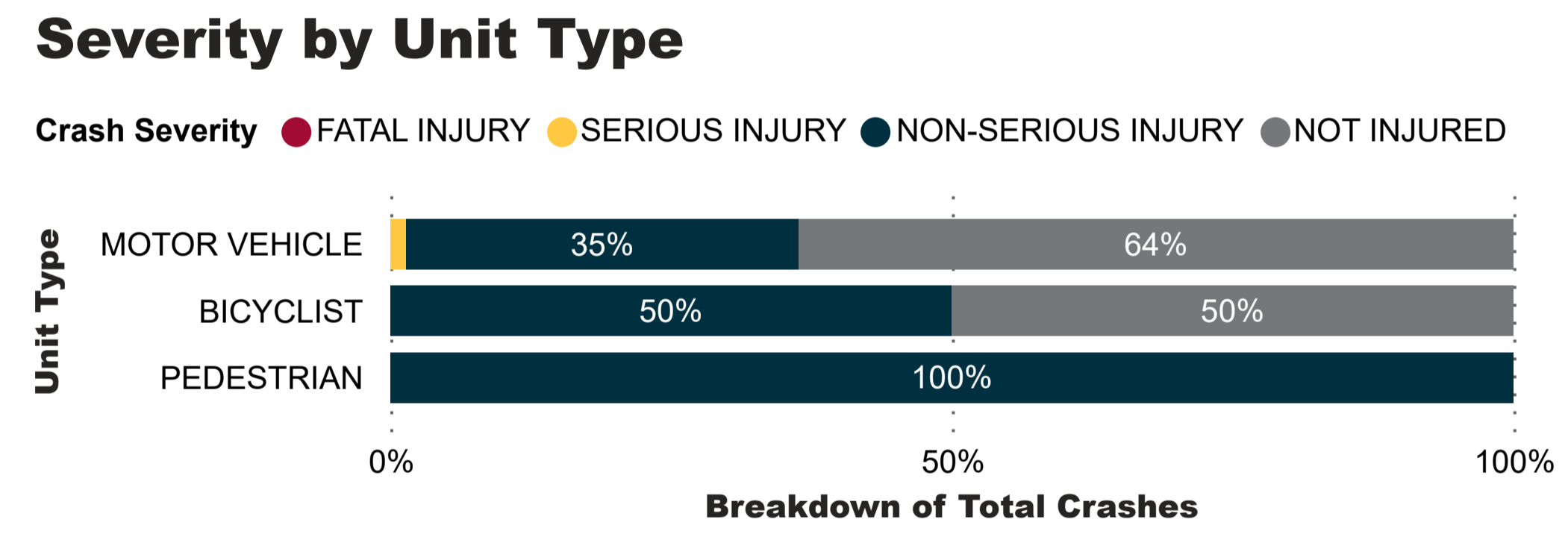
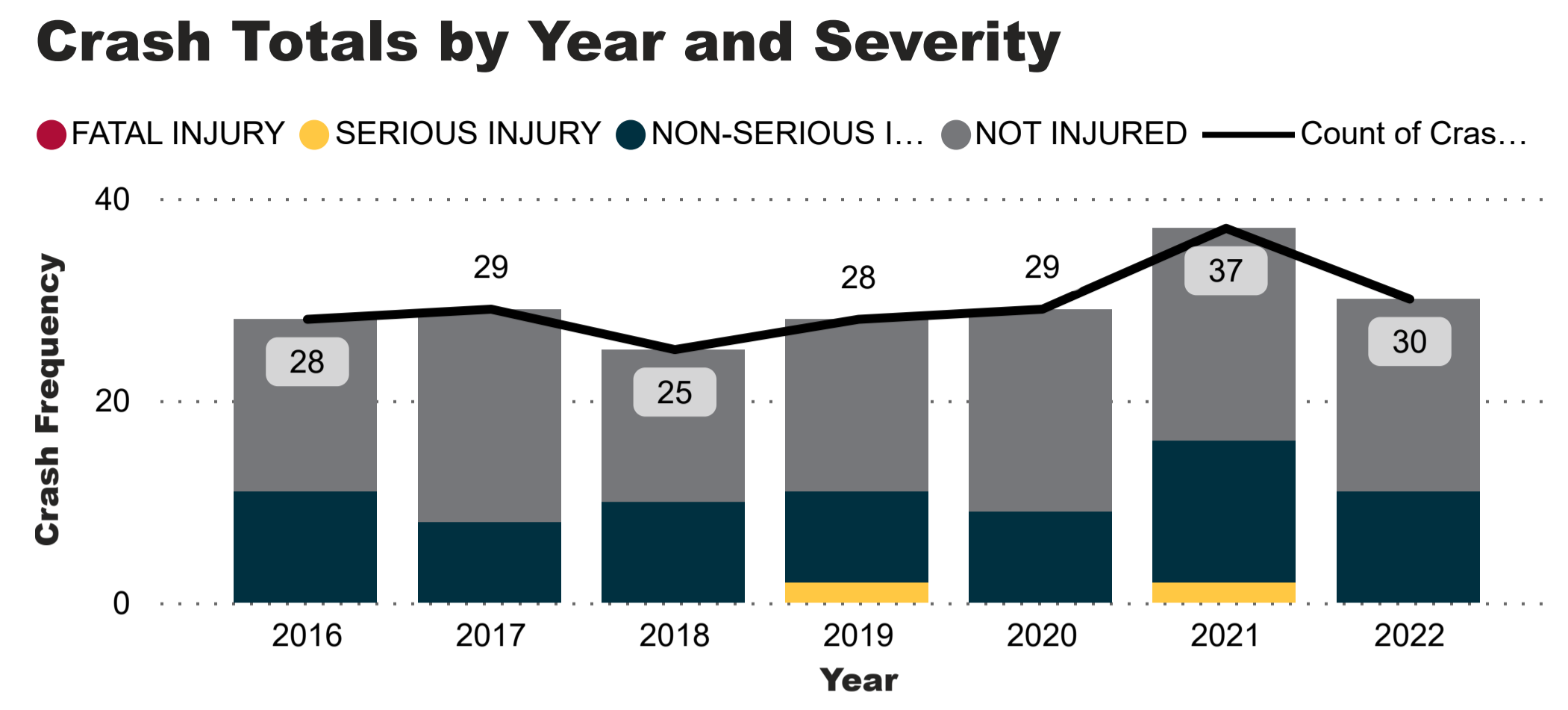
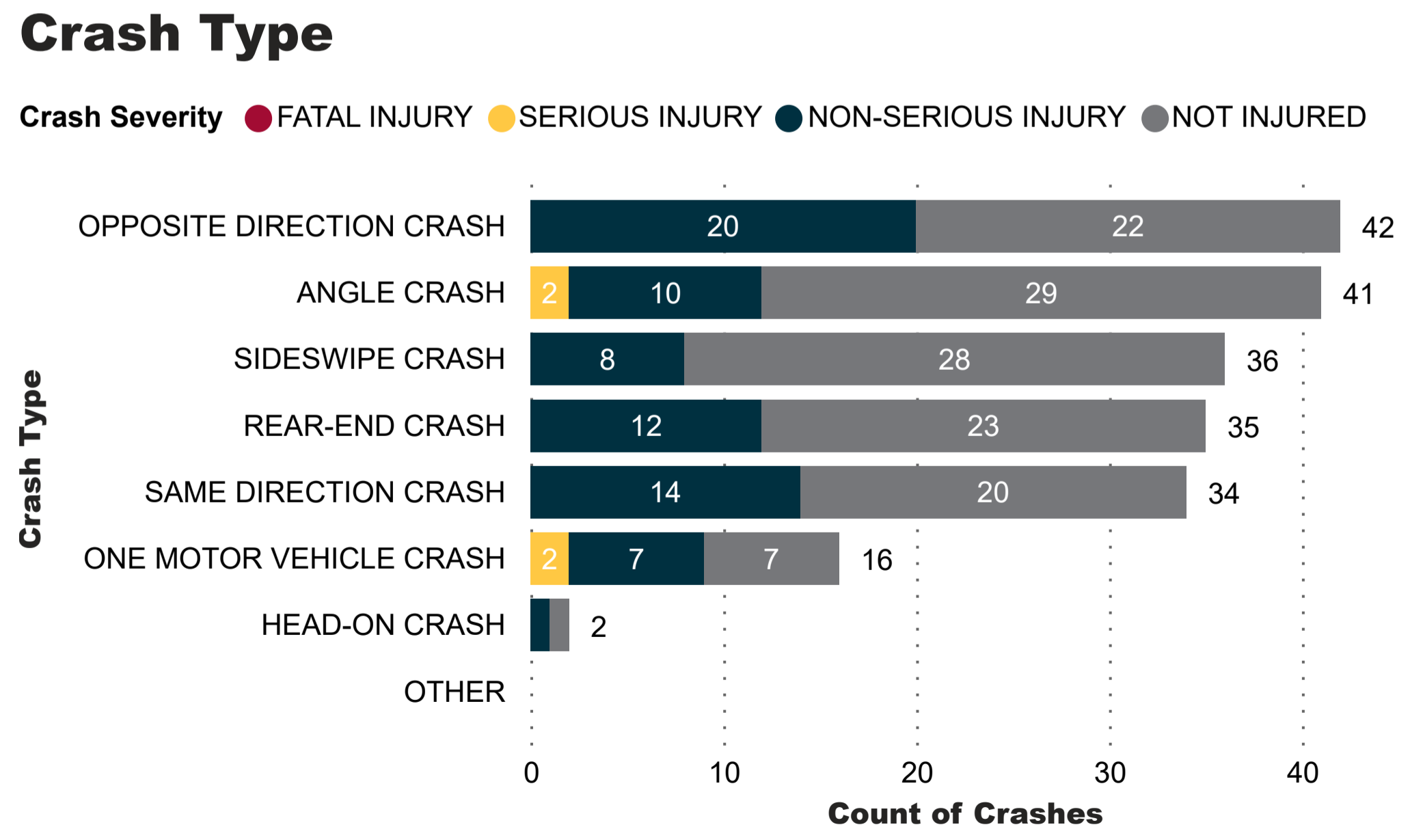
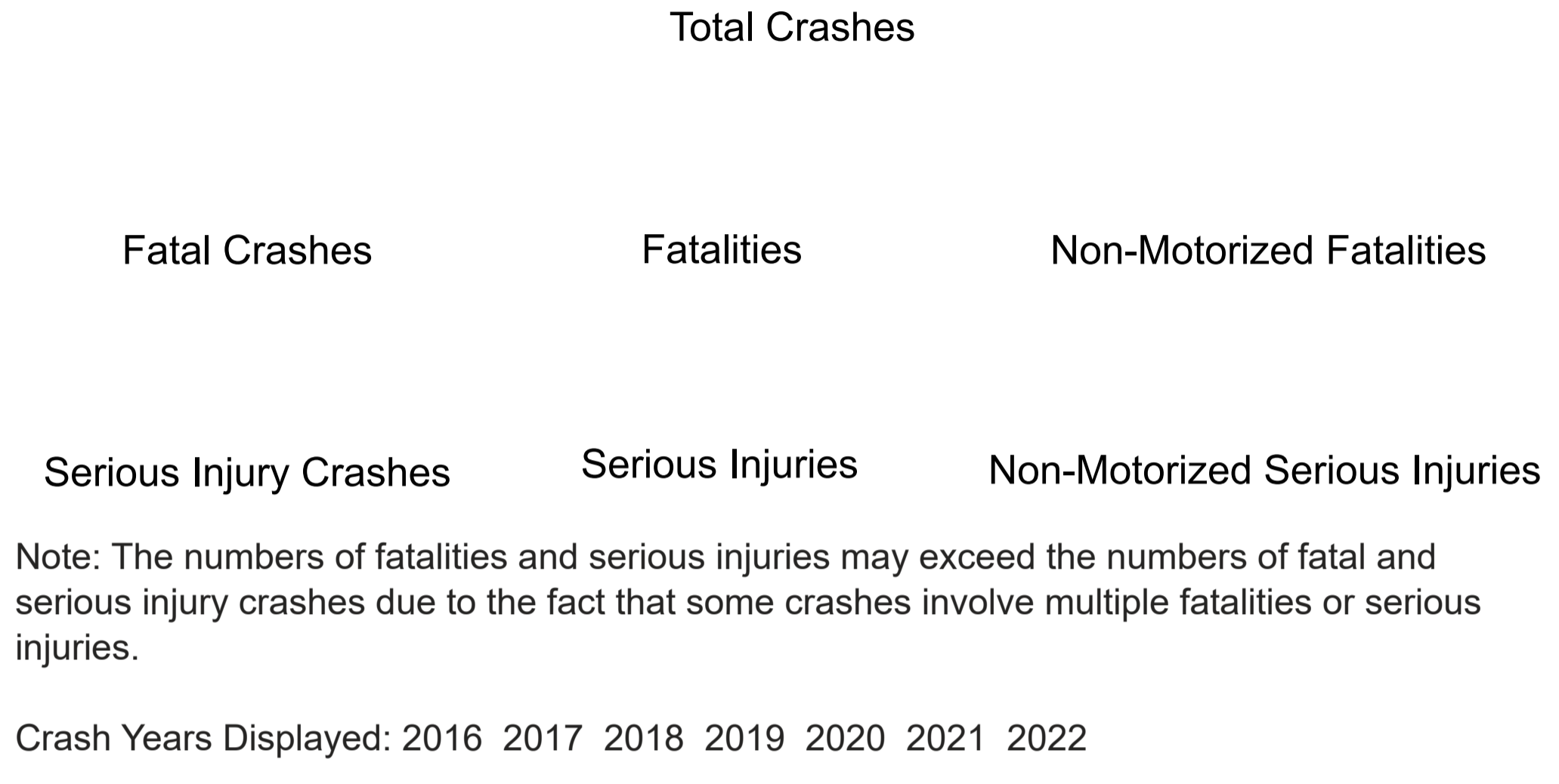



**← WHO →**

**County**  
All

**MPO**  
All

**City**  
DALLAS

**Year**  
All

**Crash Severity**  
All

**Crash Type**  
All

**Primary Contributing Factor**  
All

**Road User Type**  
All

**Vehicle Type**  
All

**Age Group**  
All

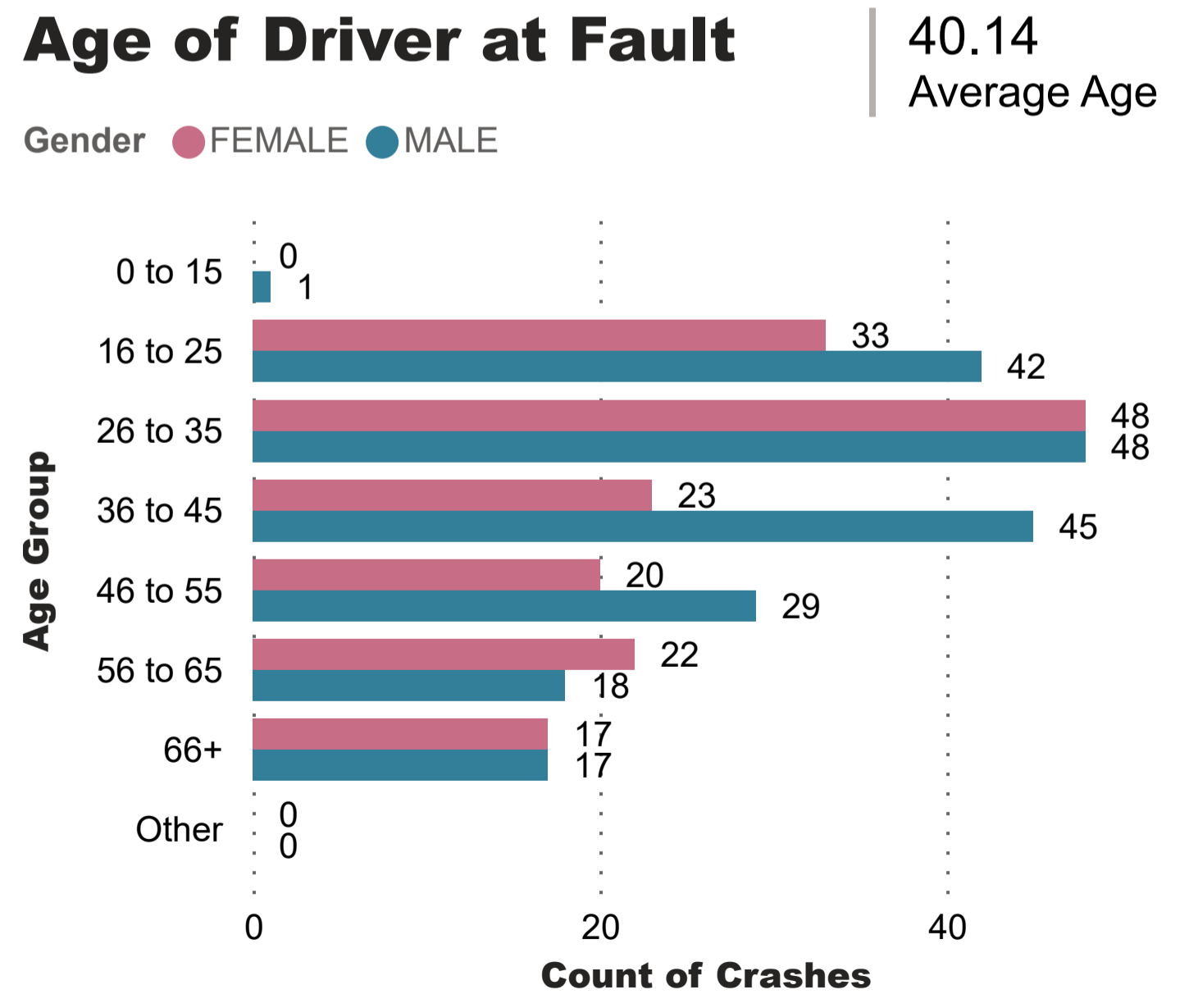
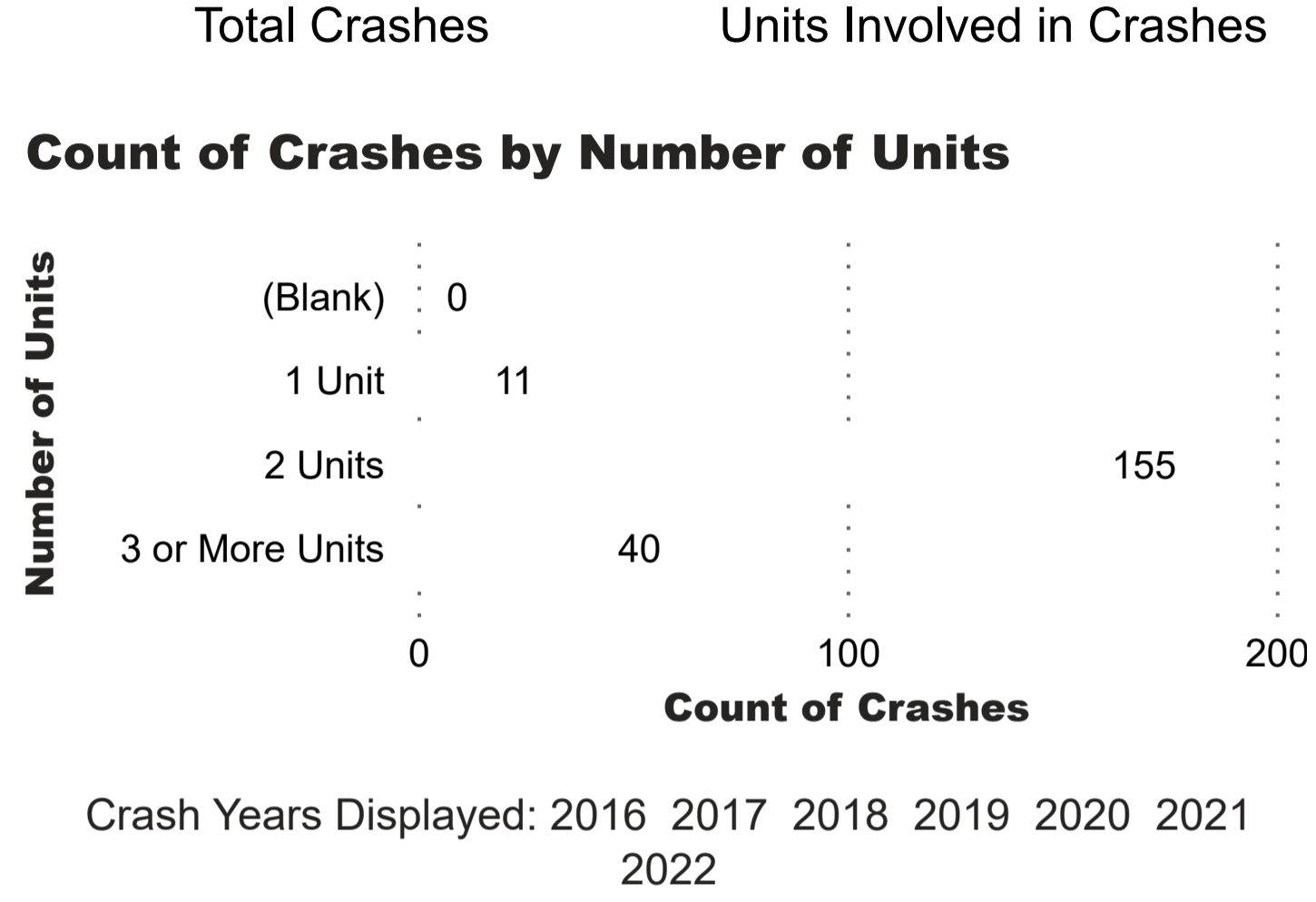

### Unit Type Breakdown

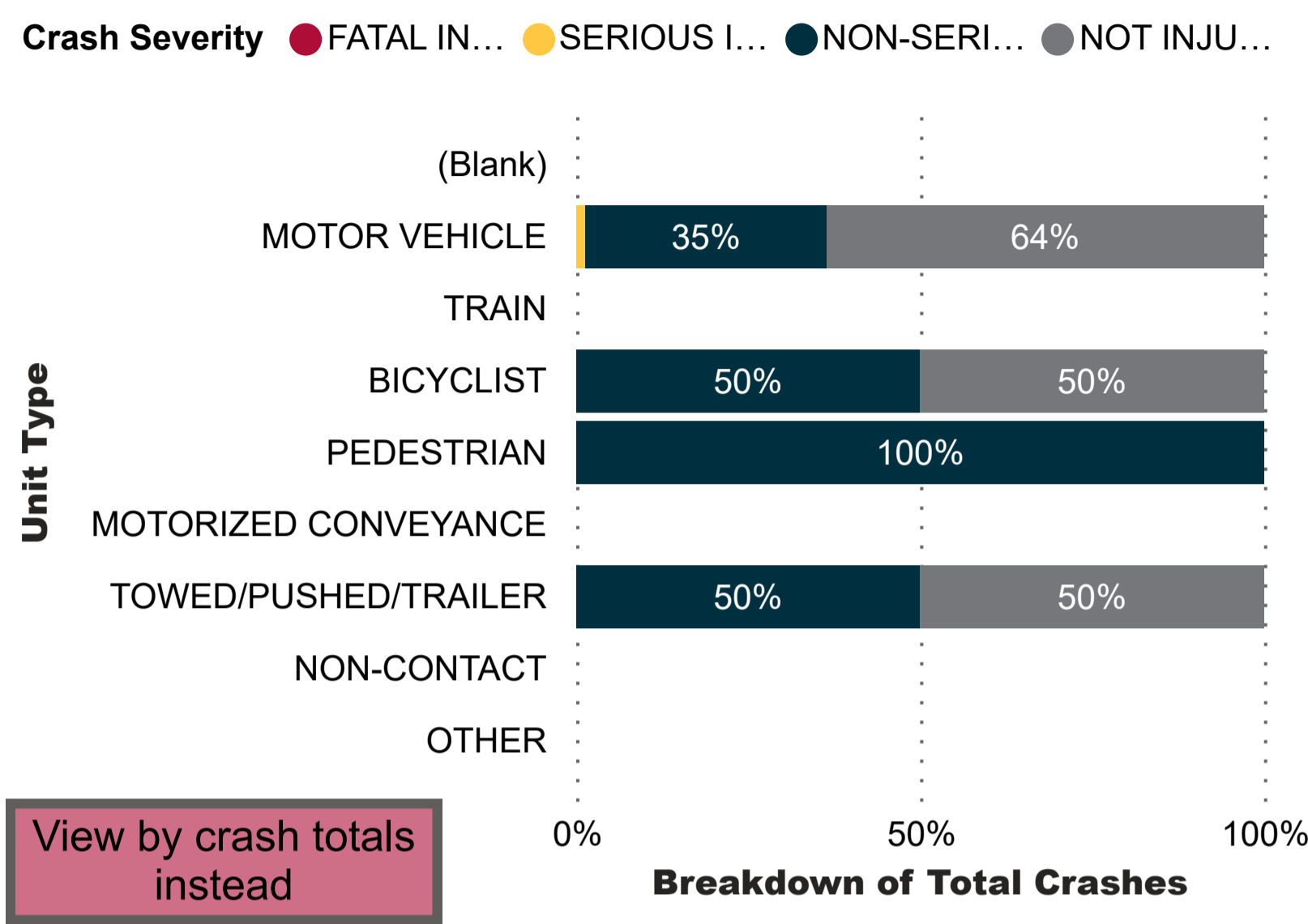

Unit Type	Count of Crashes
MOTOR VEHICLE	437
TOWED/PUSHED/TRAILER	4
BICYCLIST	2
PEDESTRIAN	2
TRAIN	0
MOTORIZED CONVEYANCE	0
NON-CONTACT	0
OTHER	0
<b>Total</b>	<b>445</b>

### Vehicle Type Breakdown

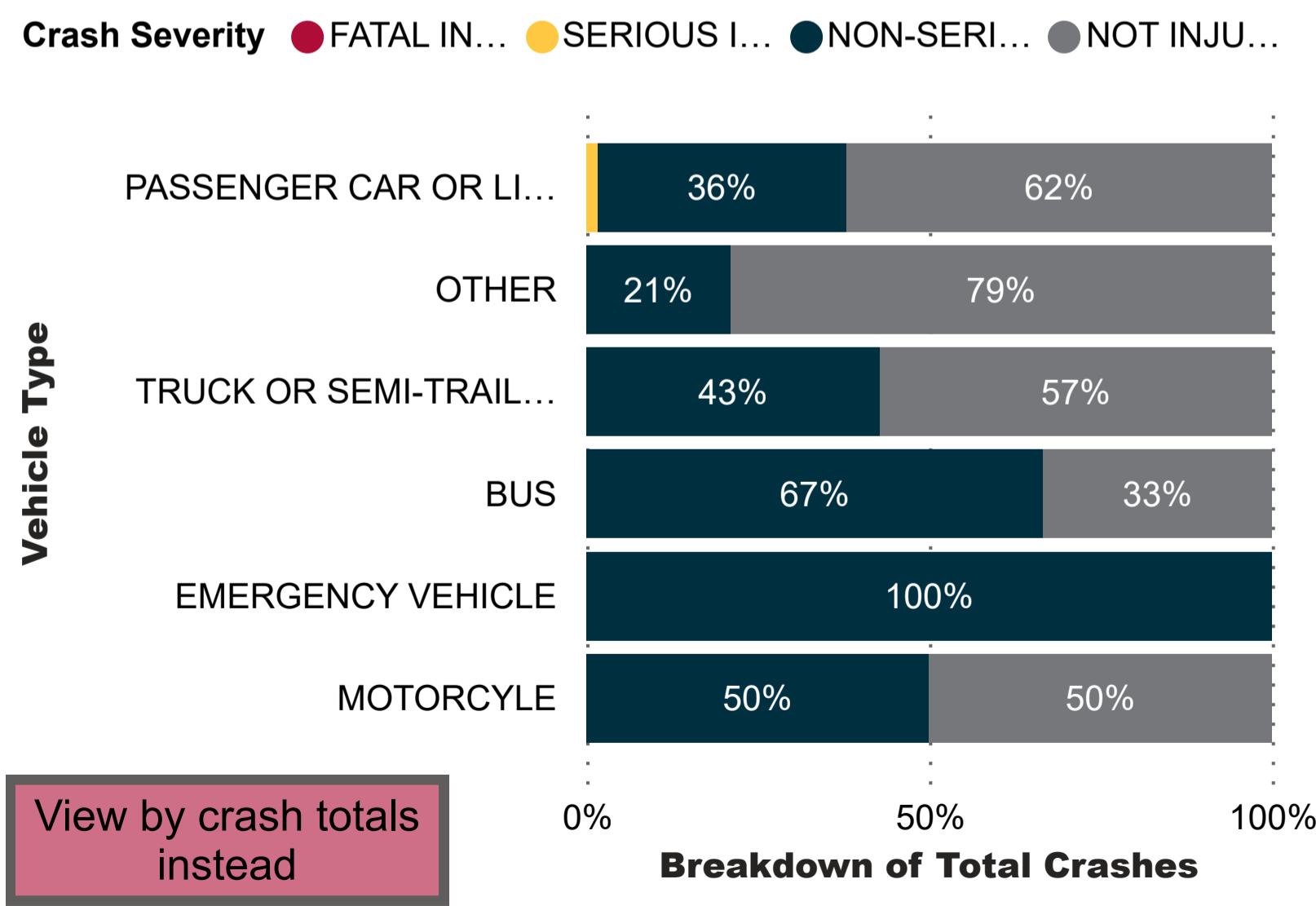

Vehicle Type	Count of Crashes
PASSENGER CAR OR LIGHT TRUCK	366
OTHER	57
TRUCK OR SEMI-TRAILER	7
BUS	3
EMERGENCY VEHICLE	2
MOTORCYCLE	2
<b>Total</b>	<b>445</b>



**WHEN**

County: All

MPO: All

City: DALLAS

Year: All

Crash Severity: All

Crash Type: All

Primary Contributing Factor: All

Road User Type: All

Vehicle Type: All

Age Group: All

### Day of Week

Total Crashes

Crash Years Displayed: 2016 2017 2018 2019 2020 2021 2022

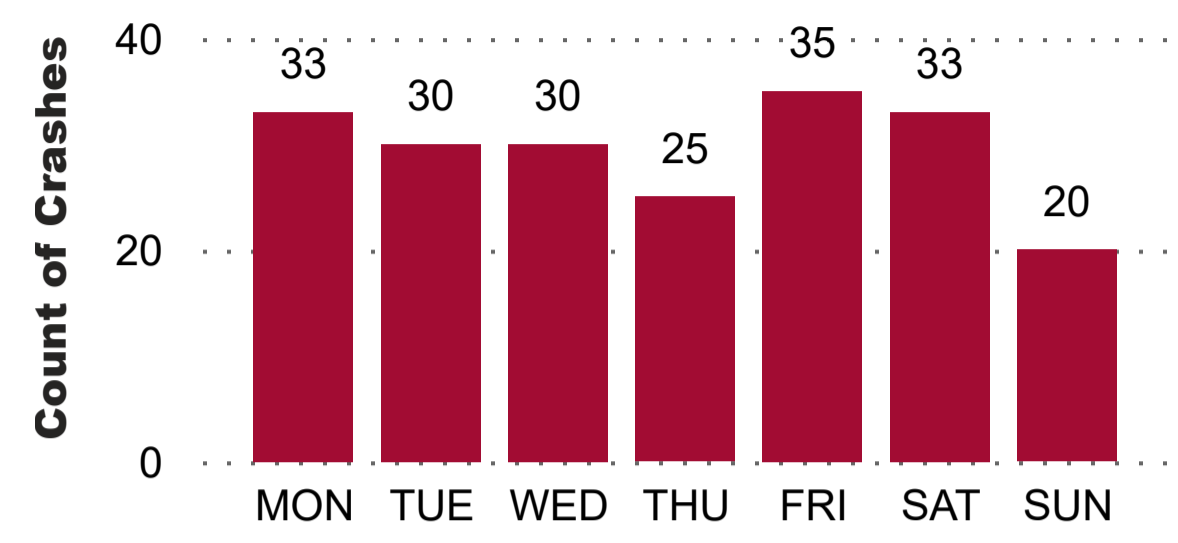

### Crash Time

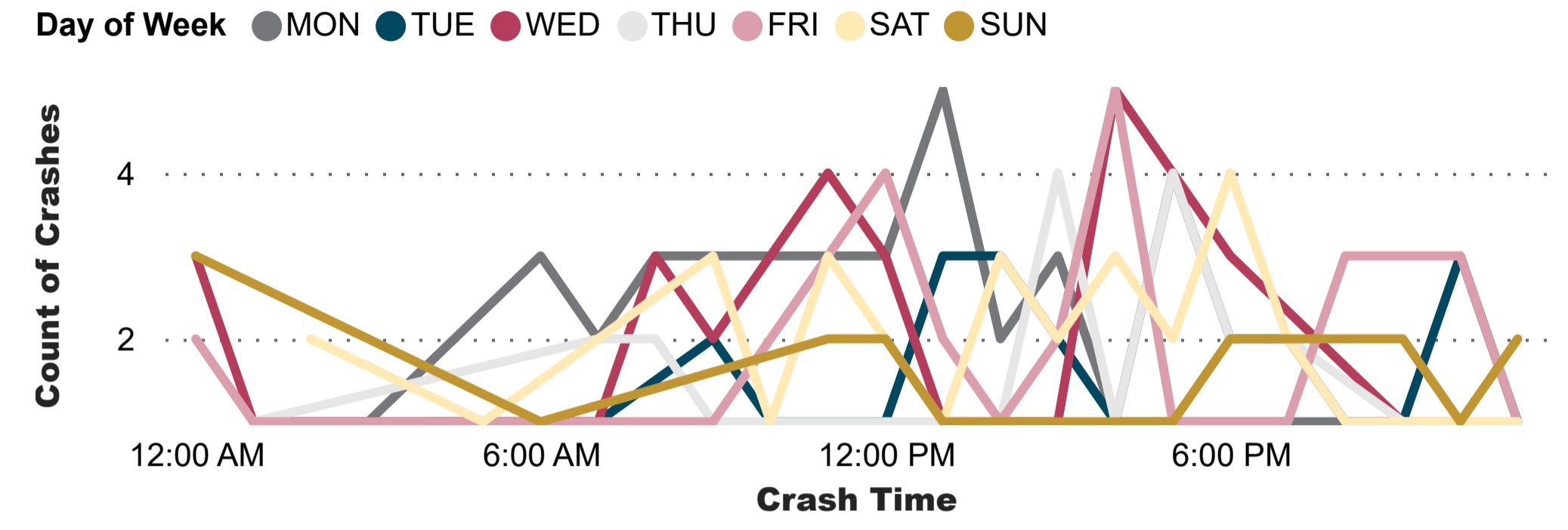

### Crash Count by Day of Week and Time of Day

Crash Time	MON	TUE	WED	THU	FRI	SAT	SUN	Total
12:00 AM			3		2		3	8
1:00 AM		1		1	1			4
2:00 AM						2		2
3:00 AM	1							1
4:00 AM			1					1
5:00 AM			1	1	1	1		4
6:00 AM	3				1		1	5
7:00 AM	2	1	1	2	1			7
8:00 AM	3		3	2				8
9:00 AM	3	2	2	1	1	3		12
10:00 AM		1			2	1		4
11:00 AM			4	1	3	3	2	13
12:00 PM	3	1	3	1	4	2	2	16
1:00 PM	5	3	1	1	2	1	1	14
2:00 PM	2	3		1	1	3	1	11
3:00 PM	3	2	1	4	2	2		14
4:00 PM	1	1	5	1	5	3		16
5:00 PM	1	4		4	1	2	1	13
6:00 PM	1	2	3	2		4	2	14
7:00 PM	1	2		2	1	2	2	10
8:00 PM	1	1			3		1	6
9:00 PM	1	1	1	1			1	7
10:00 PM	1	3	1		3		1	10
<b>Total</b>	<b>33</b>	<b>30</b>	<b>30</b>	<b>25</b>	<b>35</b>	<b>33</b>	<b>20</b>	<b>206</b>

### Total Crashes by Weather Condition

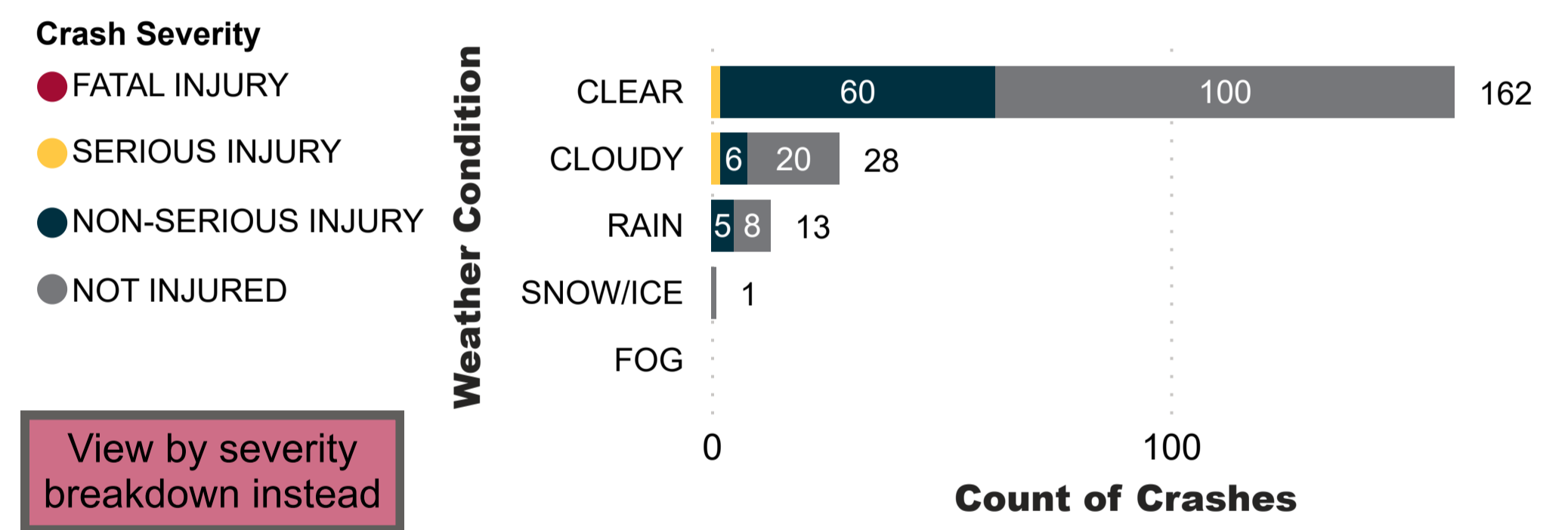

### Total Crashes by Light Condition

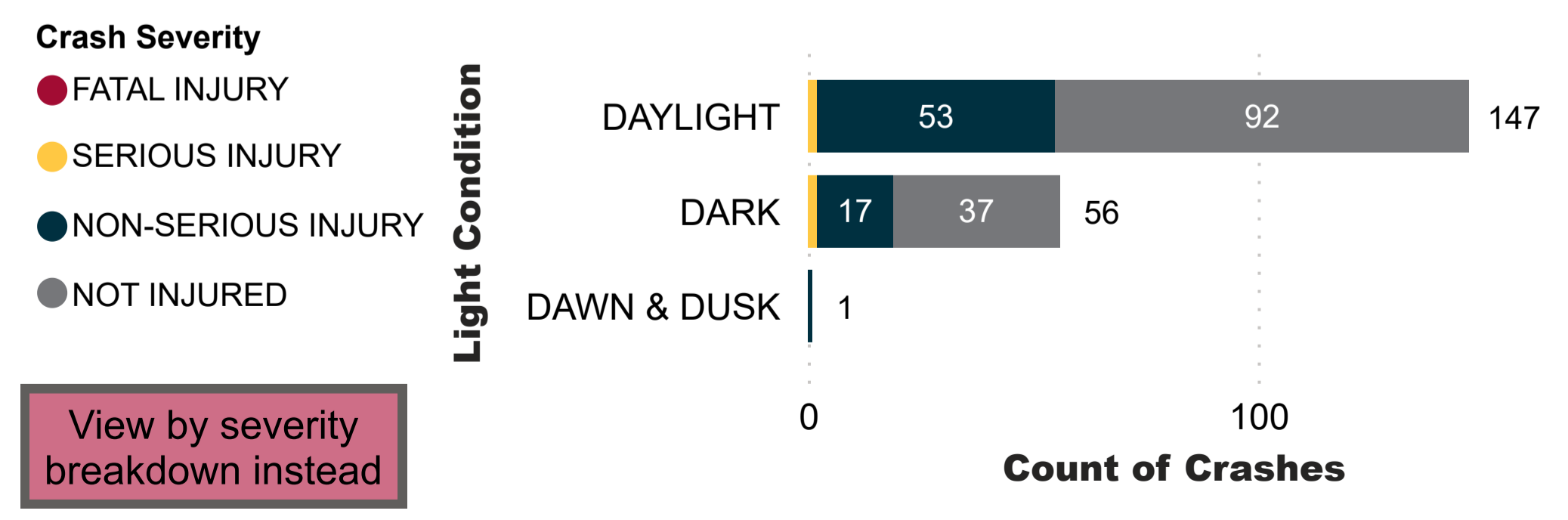

Clear all filters



**WHERE**

County: All

MPO: All

City: DALLAS

Year: All

Crash Severity: All

Crash Type: All

Primary Contributing Factor: All

Road User Type: All

Vehicle Type: All

Age Group: All

### TxDOT Roadways: On-System or Off-System

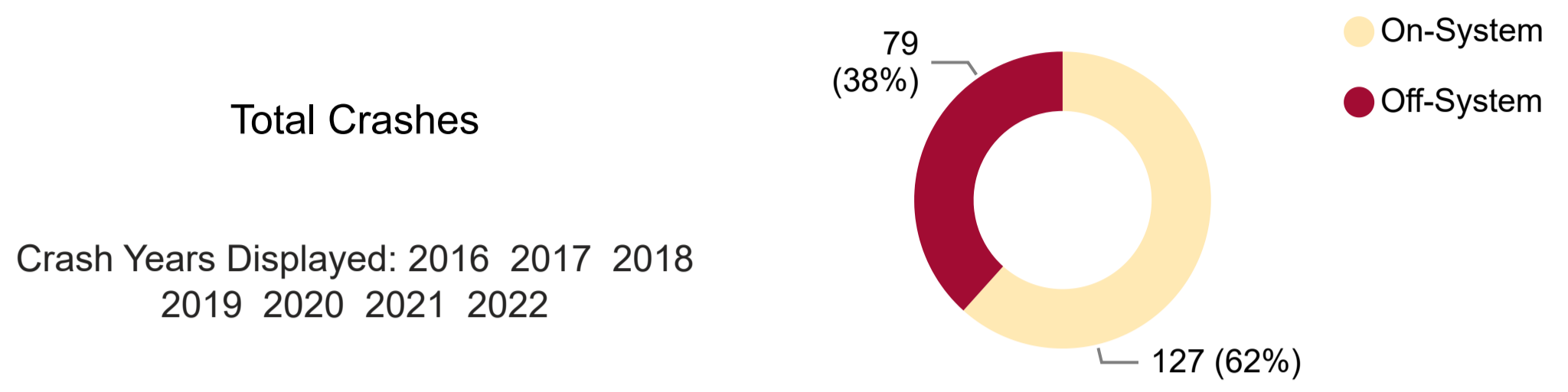

### Crash Totals by Speed Limit

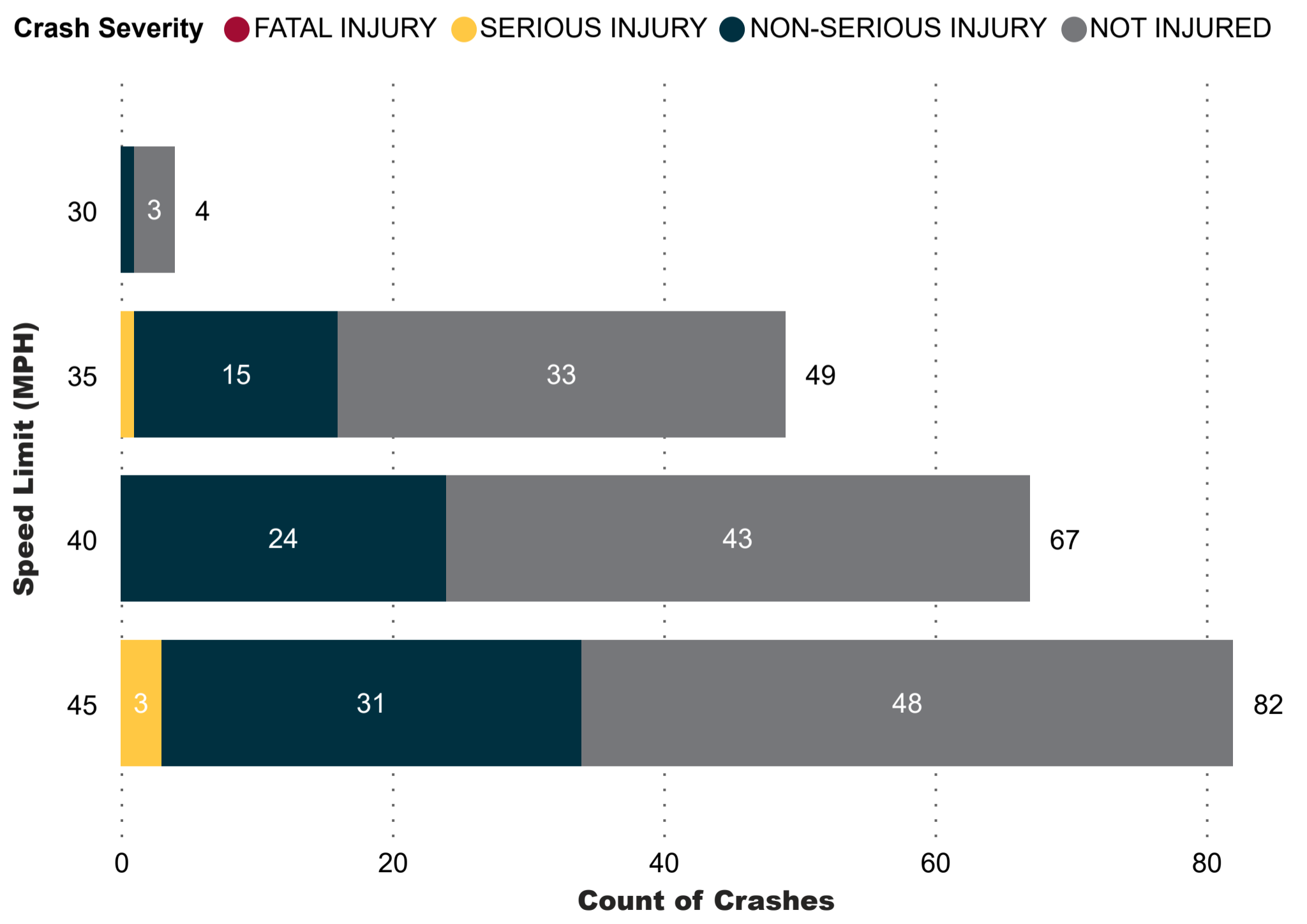

View by severity breakdown instead

### Crash Locations



Hover over the map to see if this icon appears: Click this icon for more information. This icon may indicate that the map shows a representative sample of data points. Apply more filters to see all data.

View point map by severity

### Intersection Relationship

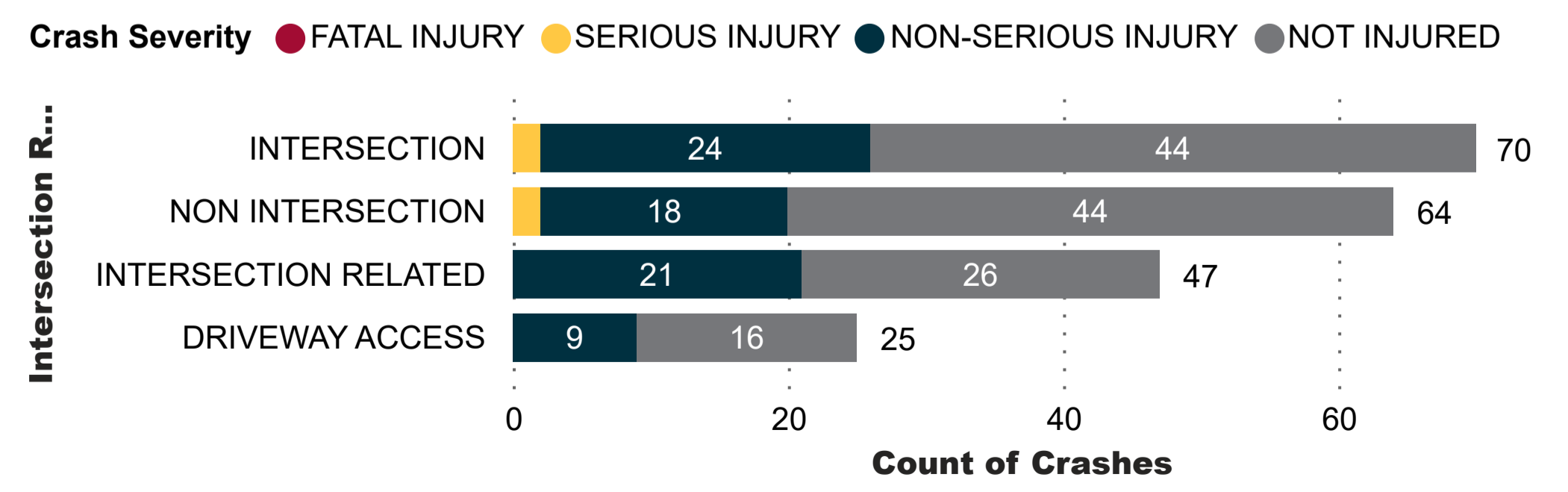

Crash Years Displayed: 2016 2017 2018 2019 2020 2021 2022

Total Crashes Fatal Crashes

### Crash Totals by Primary Contributing Factor

Crash Severity ● FATAL INJURY ● SERIOUS INJURY ● NON-SERIOUS INJURY ● NOT INJURED

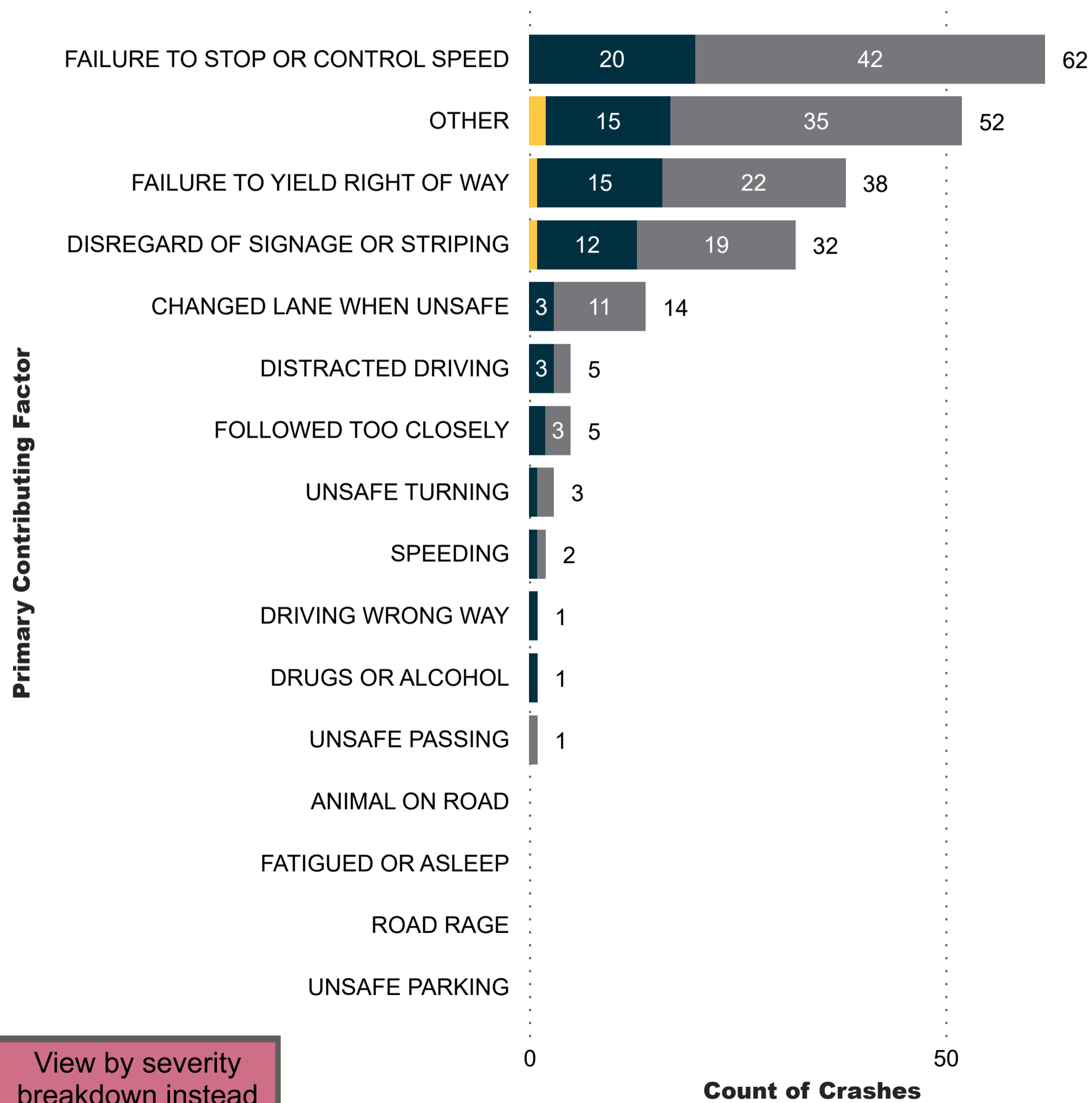

View by severity breakdown instead

### Crash Type

Crash Severity ● FATAL INJURY ● SERIOUS INJURY ● NON-SERIOUS INJURY ● NOT INJURED

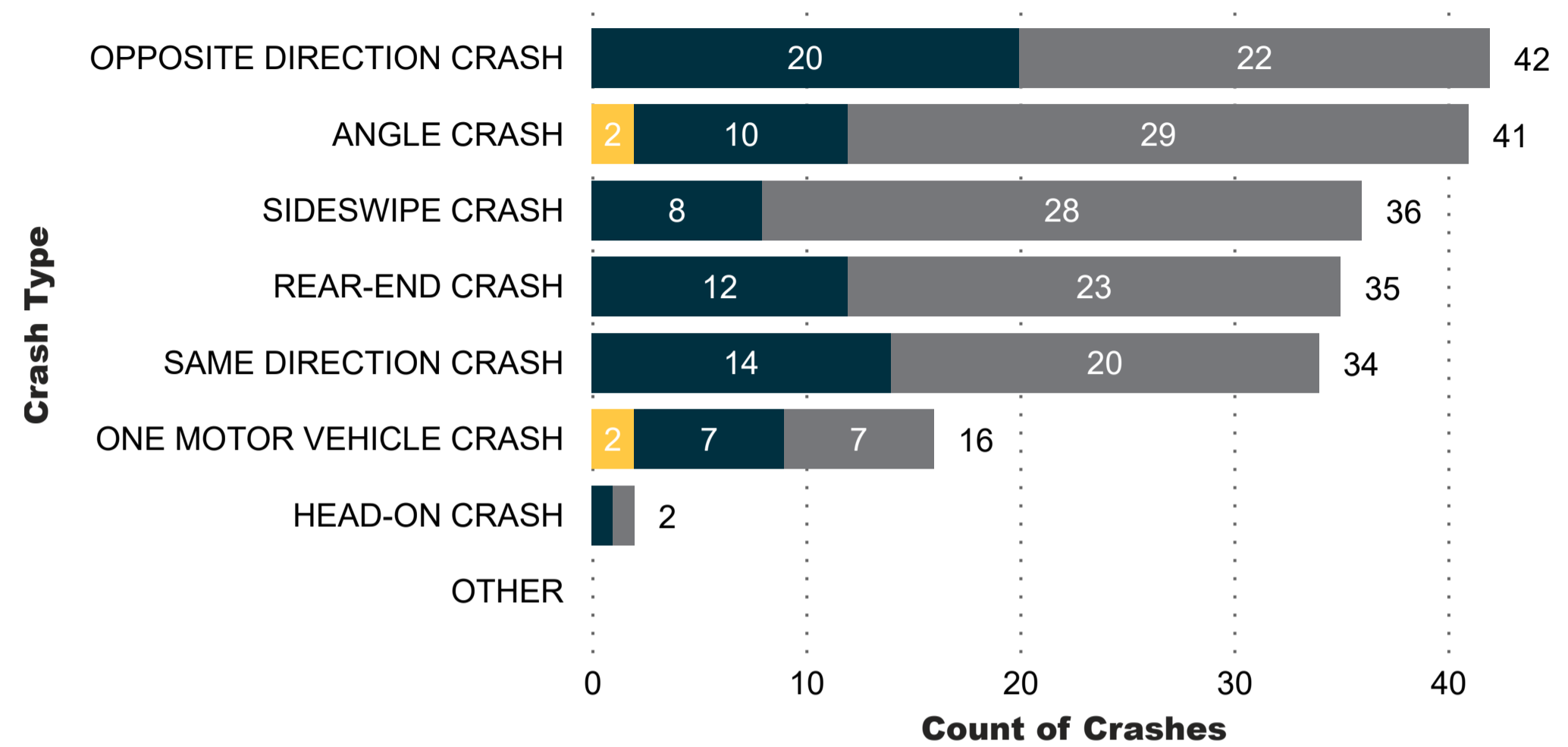

### Crash Locations

View heat map

Crash Severity ● NOT INJURED ● NON-SERIOUS INJURY ● SERIOUS INJURY

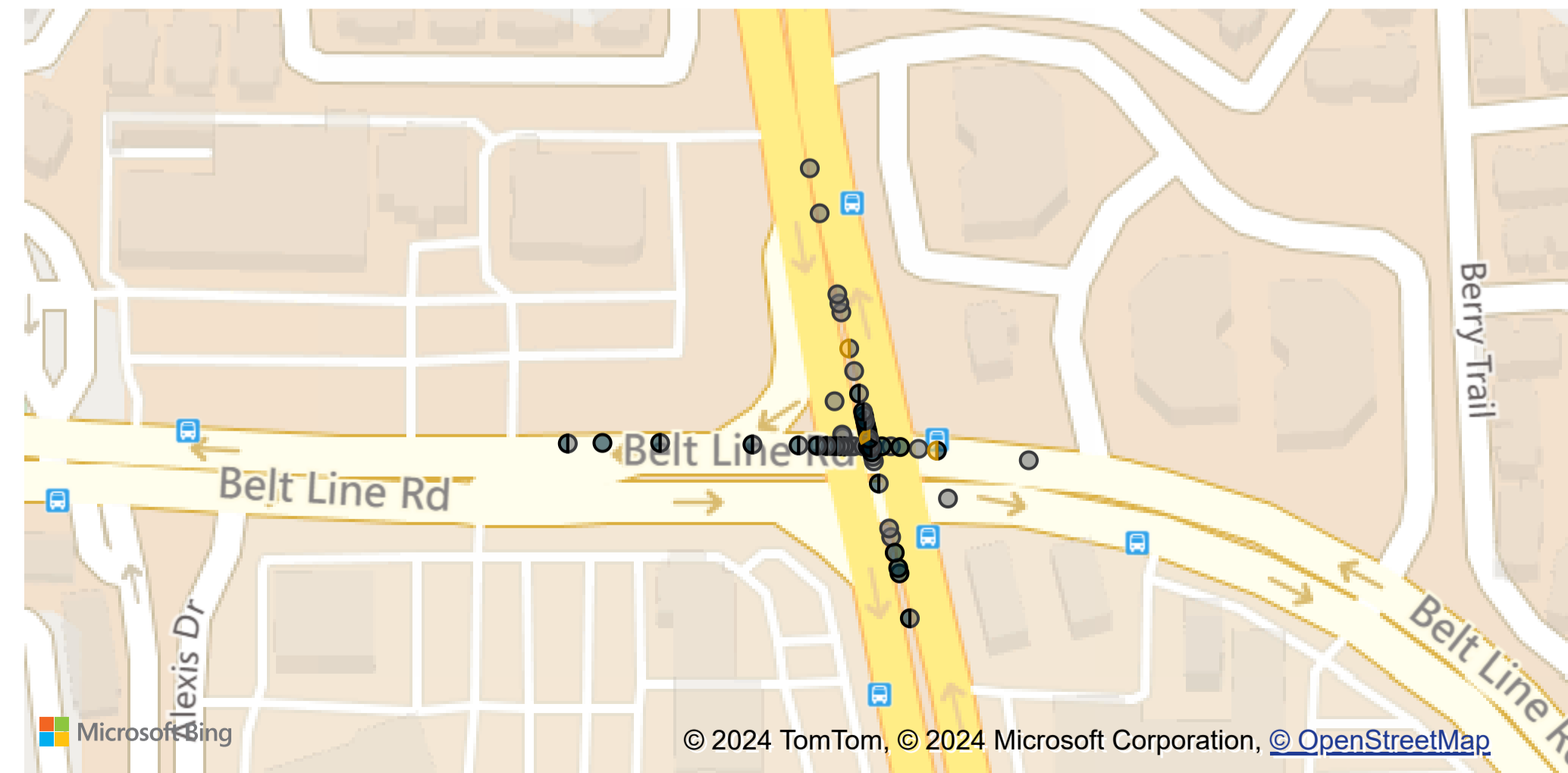

**WHY**

County: All

MPO: All

City: DALLAS

Year: All

Crash Severity: All

Crash Type: All

Primary Contributing Factor: All

Road User Type: All

Vehicle Type: All

Age Group: All

Clear all filters





# Crash Locations

Crash Severity ● NOT INJURED ● NON-SERIOUS INJURY ● SERIOUS INJURY

View heat map

206  
Count of Crashes

All Crashes

## SAFETY FOCUS AREAS MAP

County  
All

MPO  
All

City  
DALLAS

Year  
All

Latitude Range  
32.95350 32.95500

Longitude Range  
-96.80550 -96.80350

Clear all filters (Resets map to "All Crashes" view)

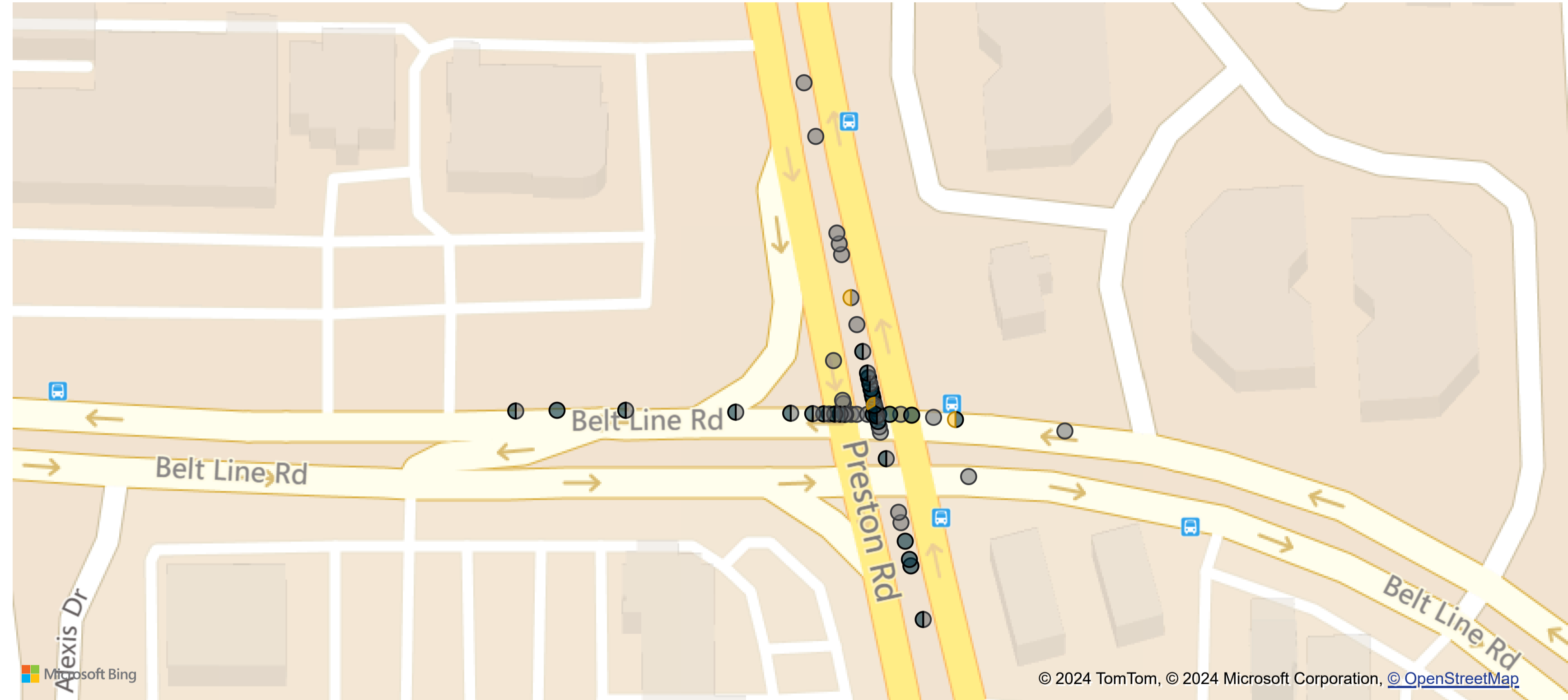

Distracted Driving Crashes

Intersection and Intersection Related Crashes

Pedestrian Crashes

Impaired Driving (Alcohol or Drugs) Crashes

Older Driver Crashes

Speeding Crashes

Run off the Road Crashes

Fatal Crashes

Serious Injury Crashes

Crashes Including Non-Motorized Fatalities

Crashes Including Non-Motorized Serious Injuries

Texas Strategic Highway Safety Program Focus Areas

Other Safety Related Performance Measures

## Count of Crashes by Year

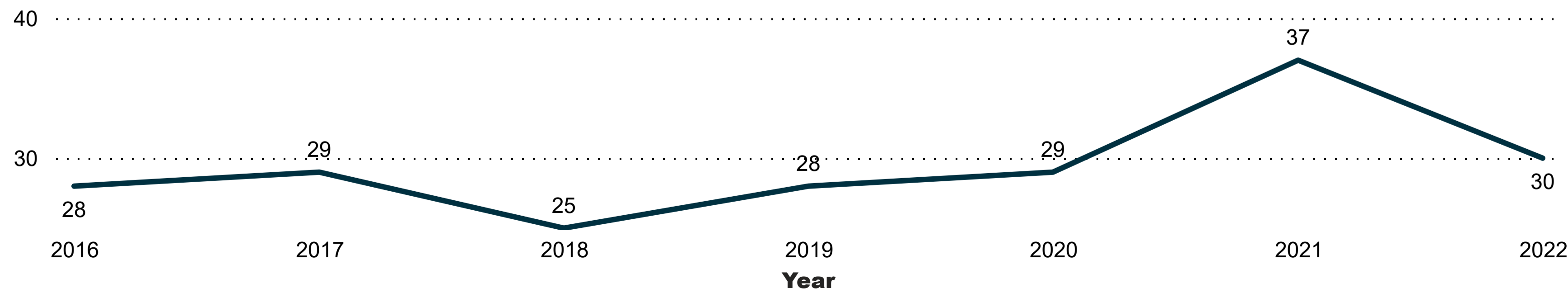

All crash data available using this tool represents reportable data collected from Texas Peace Officer's Crash Reports (CR-3) received and processed by the Texas Department of Transportation (Department as of 03/18/2024). The Department makes no warranty, representation or guaranty as to the content, accuracy, timeliness or completeness of any of the information provided as a result of your query. Reprints and conclusions derived from analysis performed on the crash data must be represented as your own and not those of the State of Texas or the Department.

Query Return Counts:  
 Query returned total count of 232 Crashes containing 502 Units and 617 Persons  
 Filters Applied to current Query:  
 Crash Year Is In 2016 or 2017 or 2018 or 2019 or 2020 or 2021 or 2022 or 2023

Crash ID	Active School Zone	Intersection	Flag	Bridge	Detail	Crash Date	Crash Death Count	Crash Number	Crash Severity	Injury Count	Crash Time	Crash Total Injury Count	Crash Year	Day of Week	Fatal	Crash Flag	Intersecting Street Name	Latitude	Longitude	Road Base	Type	Street Name
1486334 NO	NOT APPLICABLE	1/2/2016	0	0	0	20160102	0	1	N. NOT INJURED	1	1	2016	WEDNESDAY	0	0	0	PRESTON RD	32.954522	-98.804726	No Data	SHO2P9	HELL LINE RD
1488392 NO	NOT APPLICABLE	1/27/2016	0	0	20160127	0	1	B. SUSPECTED MINOR INJURY	1	1	2016	WEDNESDAY	0	0	0	PRESTON RD	32.954522	-98.804726	No Data	SHO2P9	HELL LINE RD	
1488465 NO	NOT APPLICABLE	1/27/2016	0	0	20160127	0	1	N. NOT INJURED	1	1	2016	THURSDAY	0	0	0	N/A	32.954522	-98.804726	No Data	SHO2P9	HELL LINE RD	
1488994 NO	FALSE	NOT APPLICABLE	2/4/2016	0	20160404	0	1	N. NOT INJURED	1	1	2016	SUNDAY	0	0	0	N/A	32.954522	-98.804726	No Data	SHO2P9	HELL LINE RD	
1489673 NO	FALSE	NOT APPLICABLE	3/12/2016	0	20160312	0	1	C. POSSIBLE INJURY	1	1	2016	SATURDAY	0	0	0	PRESTON RD	32.954522	-98.804726	No Data	SHO2P9	HELL LINE RD	
1497724 NO	NOT APPLICABLE	3/12/2016	0	0	20160312	0	1	N. NOT INJURED	1	1	2016	THURSDAY	0	0	0	PRESTON RD	32.954522	-98.804726	No Data	SHO2P9	HELL LINE RD	
1499631 NO	TRUE	NOT APPLICABLE	3/27/2016	0	20160327	0	0	N. NOT INJURED	1	1	2016	SUNDAY	0	0	0	PRESTON RD	32.954522	-98.804726	No Data	SHO2P9	HELL LINE RD	
1501391 NO	TRUE	NOT APPLICABLE	3/28/2016	0	20160328	0	1	B. SUSPECTED MINOR INJURY	1	1	2016	MONDAY	0	0	0	N/A	32.954522	-98.804726	No Data	SHO2P9	HELL LINE RD	
1501605 NO	FALSE	NOT APPLICABLE	4/7/2016	0	20160407	0	1	C. POSSIBLE INJURY	1	1	2016	THURSDAY	0	0	0	N/A	32.954522	-98.804726	No Data	SHO2P9	HELL LINE RD	
1504004 NO	FALSE	NOT APPLICABLE	4/14/2016	0	20160414	0	0	N. NOT INJURED	1	1	2016	THURSDAY	0	0	0	HELL LINE RD	32.954522	-98.804726	No Data	SHO2P9	HELL LINE RD	
1504631 NO	TRUE	NOT APPLICABLE	4/17/2016	0	20160417	0	0	N. NOT INJURED	1	1	2016	MONDAY	0	0	0	N/A	32.954522	-98.804726	No Data	SHO2P9	HELL LINE RD	
1509963 NO	TRUE	NOT APPLICABLE	5/4/2016	0	20160504	0	1	C. POSSIBLE INJURY	1	1	2016	WEDNESDAY	0	0	0	HELL LINE RD	32.954522	-98.804726	No Data	SHO2P9	HELL LINE RD	
1509823 NO	TRUE	NOT APPLICABLE	5/7/2016	0	20160507	0	0	N. NOT INJURED	1	1	2016	SATURDAY	0	0	0	N/A	32.954522	-98.804726	No Data	SHO2P9	HELL LINE RD	
1512670 NO	FALSE	NOT APPLICABLE	5/29/2016	0	20160529	0	0	99. UNKNOWN	25	0	2016	SUNDAY	0	0	0	N/A	32.954012	-98.803844	No Data	SHO2P9	HELL LINE RD	
1513574 NO	FALSE	NOT APPLICABLE	6/2/2016	0	20160602	0	1	C. POSSIBLE INJURY	1	1	2016	THURSDAY	0	0	0	HELL LINE RD	32.954522	-98.804726	No Data	SHO2P9	HELL LINE RD	
1519234 NO	TRUE	NOT APPLICABLE	7/1/2016	0	20160701	0	0	N. NOT INJURED	1	1	2016	FRIDAY	0	0	0	HELL LINE RD	32.954522	-98.804726	No Data	SHO2P9	HELL LINE RD	
15295102 NO	TRUE	NOT APPLICABLE	8/17/2016	0	20160817	0	0	N. NOT INJURED	1	1	2016	WEDNESDAY	0	0	0	HELL LINE RD	32.954522	-98.804726	No Data	SHO2P9	HELL LINE RD	
1533083 NO	FALSE	NOT APPLICABLE	9/4/2016	0	20160904	0	1	N. NOT INJURED	1	1	2016	SUNDAY	0	0	0	N/A	32.954522	-98.804726	No Data	SHO2P9	HELL LINE RD	
1535152 NO	FALSE	NOT APPLICABLE	10/7/2016	0	20161007	0	0	N. NOT INJURED	1	1	2016	MONDAY	0	0	0	N/A	32.954522	-98.804726	No Data	SHO2P9	HELL LINE RD	
1539383 NO	FALSE	NOT APPLICABLE	10/26/2016	0	20161026	0	0	N. NOT INJURED	1	1	2016	SATURDAY	0	0	0	N/A	32.954522	-98.804726	No Data	SHO2P9	HELL LINE RD	
1540890 NO	FALSE	NOT APPLICABLE	10/17/2016	0	20161017	0	0	N. NOT INJURED	1	1	2016	FRIDAY	0	0	0	HELL LINE RD	32.954522	-98.804726	No Data	SHO2P9	HELL LINE RD	
1539256 NO	TRUE	NOT APPLICABLE	10/22/2016	0	20161022	0	0	N. NOT INJURED	1	1	2016	SATURDAY	0	0	0	HELL LINE RD	32.954522	-98.804726	No Data	SHO2P9	HELL LINE RD	
1544786 NO	TRUE	NOT APPLICABLE	10/20/2016	0	20161020	0	1	C. POSSIBLE INJURY	4	1	2016	SUNDAY	0	0	0	N/A	32.954522	-98.804726	No Data	SHO2P9	HELL LINE RD	
1550744 NO	FALSE	NOT APPLICABLE	12/17/2016	0	20161217	0	0	C. POSSIBLE INJURY	927	1	2016	SATURDAY	0	0	0	HELL LINE RD	32.954497	-98.804805	No Data	SHO2P9	HELL LINE RD	
1552870 NO	TRUE	NOT APPLICABLE	12/20/2016	0	20161220	0	0	N. NOT INJURED	228	0	2016	FRIDAY	0	0	0	N/A	32.954522	-98.804726	No Data	SHO2P9	HELL LINE RD	
1553485 NO	FALSE	NOT APPLICABLE	12/20/2016	0	20161220	0	0	N. NOT INJURED	143	0	2016	FRIDAY	0	0	0	N/A	32.954522	-98.804726	No Data	SHO2P9	HELL LINE RD	
1556278 NO	TRUE	NOT APPLICABLE	1/13/2017	0	20170113	0	0	N. NOT INJURED	538	0	2017	FRIDAY	0	0	0	HELL LINE RD	32.954522	-98.804726	No Data	SHO2P9	HELL LINE RD	
1557493 NO	FALSE	NOT APPLICABLE	1/30/2017	0	20170130	0	0	N. NOT INJURED	1	1	2017	MONDAY	0	0	0	N/A	32.954012	-98.803844	No Data	SHO2P9	HELL LINE RD	
1557432 NO	FALSE	NOT APPLICABLE	1/30/2017	0	20170130	0	0	N. NOT INJURED	900	0	2017	MONDAY	0	0	0	HELL LINE RD	32.954522	-98.804726	No Data	SHO2P9	HELL LINE RD	
1560961 NO	TRUE	NOT APPLICABLE	2/20/2017	0	20170220	0	0	N. NOT INJURED	650	0	2017	FRIDAY	0	0	0	HELL LINE RD	32.954522	-98.804726	No Data	SHO2P9	HELL LINE RD	
1560847 NO	FALSE	NOT APPLICABLE	3/1/2017	0	20170301	0	0	N. NOT INJURED	115	0	2017	FRIDAY	0	0	0	N/A	32.954522	-98.804726	No Data	SHO2P9	HELL LINE RD	
1567843 NO	FALSE	NOT APPLICABLE	3/23/2017	0	20170323	0	1	C. POSSIBLE INJURY	1756	1	2017	THURSDAY	0	0	0	N/A	32.954201	-98.804219	No Data	SHO2P9	HELL LINE RD	
1564925 NO	NOT APPLICABLE	4/20/2017	0	0	20170420	0	0	B. SUSPECTED MINOR INJURY	1240	0	2017	FRIDAY	0	0	0	N/A	32.954522	-98.804726	No Data	SHO2P9	HELL LINE RD	
1567901 NO	TRUE	NOT APPLICABLE	3/28/2017	0	20170328	0	0	N. NOT INJURED	430	0	2017	TUESDAY	0	0	0	HELL LINE RD	32.954522	-98.804726	No Data	SHO2P9	HELL LINE RD	
1569191 NO	TRUE	NOT APPLICABLE	4/2/2017	0	20170402	0	0	N. NOT INJURED	228	0	2017	SUNDAY	0	0	0	HELL LINE RD	32.954522	-98.804726	No Data	SHO2P9	HELL LINE RD	
1569853 NO	FALSE	NOT APPLICABLE	4/7/2017	0	20170407	0	0	C. POSSIBLE INJURY	115	1	2017	FRIDAY	0	0	0	N/A	32.954522	-98.804726	No Data	SHO2P9	HELL LINE RD	
1569741 NO	FALSE	NOT APPLICABLE	4/7/2017	0	20170407	0	0	N. NOT INJURED	580	0	2017	FRIDAY	0	0	0	N/A	32.954012	-98.803844	No Data	SHO2P9	HELL LINE RD	
1569807 NO	NOT APPLICABLE	4/7/2017	0	0	20170407	0	0	C. POSSIBLE INJURY	228	0	2017	FRIDAY	0	0	0	N/A	32.954522	-98.804726	No Data	SHO2P9	HELL LINE RD	
1573281 NO	TRUE	NOT APPLICABLE	4/14/2017	0	20170414	0	0	N. NOT INJURED	1545	0	2017	FRIDAY	0	0	0	HELL LINE RD	32.954522	-98.804726	No Data	SHO2P9	HELL LINE RD	
1571221 NO	TRUE	NOT APPLICABLE	4/23/2017	0	20170423	0	3	C. POSSIBLE INJURY	1242	3	2017	SUNDAY	0	0	0	HELL LINE RD	32.954522	-98.804726	No Data	SHO2P9	HELL LINE RD	
1581847 NO	FALSE	NOT APPLICABLE	4/12/2017	0	20170412	0	0	B. SUSPECTED MINOR INJURY	630	0	2017	MONDAY	0	0	0	N/A	32.954522	-98.804726	No Data	SHO2P9	HELL LINE RD	
1581725 NO	FALSE	NOT APPLICABLE	6/14/2017	0	20170614	0	2	C. POSSIBLE INJURY	2107	2	2017	WEDNESDAY	0	0	0	N/A	32.954522	-98.804726	No Data	SHO2P9	HELL LINE RD	
1582119 NO	FALSE	NOT APPLICABLE	6/20/2017	0	20170620	0	1	C. POSSIBLE INJURY	123	1	2017	MONDAY	0	0	0	N/A	32.953992	-98.803786	No Data	SHO2P9	HELL LINE RD	
1583192 NO	FALSE	NOT APPLICABLE	6/27/2017	0	20170627	0	0	N. NOT INJURED	1350	0	2017	TUESDAY	0	0	0	HELL LINE RD	32.954522	-98.804726	No Data	SHO2P9	HELL LINE RD	
1586730 NO	FALSE	NOT APPLICABLE	7/17/2017	0	20170717	0	0	N. NOT INJURED	1245	0	2017	MONDAY	0	0	0	N/A	32.954522	-98.804726	No Data	SHO2P9	HELL LINE RD	
1590719 NO	FALSE	NOT APPLICABLE	8/25/2017	0	20170825	0	0	N. NOT INJURED	180	0	2017	SATURDAY	0	0	0	N/A	32.954522	-98.804726	No Data	SHO2P9	HELL LINE RD	
1591078 NO	FALSE	NOT APPLICABLE	8/17/2017	0	20170817	0	0	N. NOT INJURED	205	0	2017	FRIDAY	0	0	0	N/A	32.954012	-98.803844	No Data	SHO2P9	HELL LINE RD	
1593027 NO	FALSE	NOT APPLICABLE	11/8/2017	0	20171108	0	0	N. NOT INJURED	140	0	2017	WEDNESDAY	0	0	0	N/A	32.954522	-98.804726	No Data	SHO2P9	HELL LINE RD	
1598281 NO	FALSE	NOT APPLICABLE	9/22/2017	0	20170922	0	0	N. NOT INJURED	0	0	2017	FRIDAY	0	0	0	HELL LINE RD	32.954012	-98.803844	No Data	SHO2P9	HELL LINE RD	
1601736 NO	FALSE	NOT APPLICABLE	10/6/2017	0	20171006	0	0	N. NOT INJURED	1232	0	2017	FRIDAY	0	0	0	N/A	32.954947	-98.804805	No Data	SHO2P9	HELL LINE RD	
1607638 NO	FALSE	NOT APPLICABLE	10/12/2017	0	20171012	0	0	N. NOT INJURED	2156	0	2017	SUNDAY	0	0	0	N/A	32.954522	-98.804726	No Data	SHO2P9	HELL LINE RD	
1608210 NO	TRUE	NOT APPLICABLE	11/17/2017	0	20171117	0	3	C. POSSIBLE INJURY	2015	3	2017	SATURDAY	0	0	0	HELL LINE RD	32.954522	-98.804726	No Data	SHO2P9	HELL LINE RD	
1613255 NO	NOT APPLICABLE	12/6/2017	0	0	20171206	0	0	C. POSSIBLE INJURY	133	0	2017	WEDNESDAY	0	0	0	N/A	32.954522	-98.804726	No Data	SHO2P9	HELL LINE RD	
1612588 NO	FALSE	NOT APPLICABLE	12/6/2017	0	20171206	0	0	N. NOT INJURED	1950	0	2017	WEDNESDAY	0	0	0	HELL LINE RD	32.954522	-98.804726	No Data	SHO2P9	HELL LINE RD	

18807715 NO	FALSE	NOT APPLICABLE	3/15/2022	0	2022122985	0 N - NOT INJURED	2325	0	2022 TUESDAY	No Data	N/A	32 95403449	-96.8041569	No Data	SH0289
18891234 NO	TRUE	NOT APPLICABLE	5/5/2022	0	2022208993	0 N - NOT INJURED	1940	0	2022 THURSDAY	No Data	BELT LINE RD	32 95407652	-96.80408703	No Data	SH0289
18928954 NO	FALSE	NOT APPLICABLE	5/11/2022	0	202243981	0 N - NOT INJURED	1200	0	2022 WEDNESDAY	No Data	N/A	32 9539437	-96.80405222	No Data	SH0289
18918546 NO	TRUE	NOT APPLICABLE	5/14/2022	0	202233565	2 C - POSSIBLE INJURY	1129	2	2022 SATURDAY	No Data	BELT LINE RD	32 95407652	-96.80408703	No Data	SH0289
18940898 NO	FALSE	NOT APPLICABLE	5/22/2022	0	202255907	1 C - POSSIBLE INJURY	2315	1	2022 SUNDAY	No Data	N/A	32 95405206	-96.80423788	No Data	BELT LINE RD
18951106 NO	TRUE	NOT APPLICABLE	5/31/2022	0	202266012	0 N - NOT INJURED	1720	0	2022 TUESDAY	No Data	BELT LINE RD	32 95407652	-96.80408703	No Data	SH0289
18961120 NO	TRUE	NOT APPLICABLE	6/9/2022	0	202275921	0 N - NOT INJURED	1350	0	2022 THURSDAY	No Data	BELT LINE RD	32 95407652	-96.80408703	No Data	SH0289
18955055 NO	FALSE	NOT APPLICABLE	6/10/2022	0	202269927	1 C - POSSIBLE INJURY	2018	1	2022 FRIDAY	No Data	SH0289	32 95405206	-96.80397667	No Data	BELT LINE RD
19019380 NO	TRUE	NOT APPLICABLE	7/12/2022	0	2022334020	0 N - NOT INJURED	2017	0	2022 TUESDAY	No Data	HH085	32 95407652	-96.80408703	No Data	SH0289
19046240 NO	FALSE	NOT APPLICABLE	7/23/2022	0	2022360716	0 N - NOT INJURED	1534	0	2022 SATURDAY	No Data	N/A	32 95402924	-96.80407326	No Data	SH0289
19064794 NO	TRUE	NOT APPLICABLE	8/4/2022	0	2022378699	0 B - SUSPECTED MINOR INJURY	1530	1	2022 THURSDAY	No Data	PRESTON RD	32 95405422	-96.80417226	No Data	BELT LINE RD
19084766 NO	TRUE	NOT APPLICABLE	8/11/2022	0	202299588	0 B - SUSPECTED MINOR INJURY	809	1	2022 THURSDAY	No Data	BELT LINE RD	32 95407652	-96.80408703	No Data	SH0289
19064247 NO	FALSE	NOT APPLICABLE	8/16/2022	0	2022378752	0 N - NOT INJURED	1828	0	2022 TUESDAY	No Data	N/A	32 95405422	-96.80417226	No Data	SH0289
19096049 NO	FALSE	NOT APPLICABLE	8/24/2022	0	2022418542	0 N - NOT INJURED	724	0	2022 WEDNESDAY	No Data	N/A	32 95407171	-96.80321173	No Data	BELT LINE RD
19087554 NO	FALSE	NOT APPLICABLE	8/30/2022	0	2022401746	1 C - POSSIBLE INJURY	935	1	2022 TUESDAY	No Data	N/A	32 95354328	-96.80394244	No Data	SH0289
19115134 NO	FALSE	NOT APPLICABLE	8/30/2022	0	202249693	0 N - NOT INJURED	1355	0	2022 TUESDAY	No Data	N/A	32 95405422	-96.80409922	No Data	BELT LINE RD
19197139 NO	TRUE	NOT APPLICABLE	9/22/2022	0	202251942	1 C - POSSIBLE INJURY	1722	1	2022 THURSDAY	No Data	BELT LINE RD	32 95407652	-96.80408703	No Data	SH0289
19147295 NO	FALSE	NOT APPLICABLE	9/25/2022	0	2022463619	0 N - NOT INJURED	1945	0	2022 SUNDAY	No Data	SH0289	32 95405428	-96.80417382	No Data	BELT LINE RD
19298802 NO	TRUE	NOT APPLICABLE	12/20/2022	0	2022620728	0 N - NOT INJURED	936	0	2022 TUESDAY	No Data	BELT LINE RD	32 95407652	-96.80408703	No Data	SH0289
19309773 NO	FALSE	NOT APPLICABLE	12/23/2022	0	2022631617	0 N - NOT INJURED	1000	0	2022 FRIDAY	No Data	N/A	32 95415691	-96.80410799	No Data	SH0289
1931427 NO	TRUE	NOT APPLICABLE	12/28/2022	0	2022635677	0 N - NOT INJURED	1110	0	2022 WEDNESDAY	No Data	BELT LINE RD	32 95407652	-96.80408703	No Data	SH0289
19314274 NO	TRUE	NOT APPLICABLE	12/31/2022	0	2022635640	0 N - NOT INJURED	1600	0	2022 SATURDAY	No Data	BELT LINE RD	32 95407652	-96.80408703	No Data	SH0289

**Synchro™ Output – 2021 Existing Traffic**

Pepper Square TIA  
Lanes, Volumes, Timings

2021 - Existing - AM  
1335: Meadow Creek & Belt Line



Lane Group	EBL	EBT	EBR	WBL	WBT	WBR	NBL	NBT	NBR	SBL	SBT	SBR
Lane Configurations	↔	↑↑↑		↔	↑↑↑			↕				↕
Traffic Volume (vph)	28	567	15	3	1021	17	20	3	6	8	9	79
Future Volume (vph)	28	567	15	3	1021	17	20	3	6	8	9	79
Ideal Flow (vphpl)	1900	1900	1900	1900	1900	1900	1900	1900	1900	1900	1900	1900
Storage Length (ft)	150		0	150		0	0		0	0		0
Storage Lanes	1		0	1		0	0		0	0		0
Taper Length (ft)	25			25			25			25		
Lane Util. Factor	1.00	0.91	0.91	1.00	0.91	0.91	1.00	1.00	1.00	1.00	1.00	1.00
Frt		0.996			0.998			0.974			0.890	
Flt Protected	0.950			0.950				0.966			0.996	
Satd. Flow (prot)	1770	5065	0	1770	5075	0	0	1753	0	0	1651	0
Flt Permitted	0.229			0.398				0.722			0.977	
Satd. Flow (perm)	427	5065	0	741	5075	0	0	1310	0	0	1620	0
Right Turn on Red			Yes			Yes			Yes			Yes
Satd. Flow (RTOR)		5			3			6			85	
Link Speed (mph)	42			42				30			30	
Link Distance (ft)	1673			2404				392			423	
Travel Time (s)	27.2			39.0				8.9			9.6	
Peak Hour Factor	0.93	0.93	0.93	0.93	0.93	0.93	0.93	0.93	0.93	0.93	0.93	0.93
Adj. Flow (vph)	30	610	16	3	1098	18	22	3	6	9	10	85
Shared Lane Traffic (%)												
Lane Group Flow (vph)	30	626	0	3	1116	0	0	31	0	0	104	0
Enter Blocked Intersection	No	No	No	No	No	No	No	No	No	No	No	No
Lane Alignment	Left	Left	Right	Left	Left	Right	Left	Left	Right	Left	Left	Right
Median Width(ft)	12			12				0			0	
Link Offset(ft)	0			0				0			0	
Crosswalk Width(ft)	16			16				16			16	
Two way Left Turn Lane												
Headway Factor	1.00	1.00	1.00	1.00	1.00	1.00	1.00	1.00	1.00	1.00	1.00	1.00
Turning Speed (mph)	15		9	15		9	15		9	15		9
Number of Detectors	1	1		1	1		1	1		1	1	1
Detector Template												
Leading Detector (ft)	50	50		50	50		50	50		50	50	
Trailing Detector (ft)	0	0		0	0		0	0		0	0	
Detector 1 Position(ft)	0	0		0	0		0	0		0	0	
Detector 1 Size(ft)	50	50		50	50		50	50		50	50	
Detector 1 Type	Cl+Ex	Cl+Ex		Cl+Ex	Cl+Ex		Cl+Ex	Cl+Ex		Cl+Ex	Cl+Ex	
Detector 1 Channel												
Detector 1 Extend (s)	0.0	0.0		0.0	0.0		0.0	0.0		0.0	0.0	
Detector 1 Queue (s)	0.0	0.0		0.0	0.0		0.0	0.0		0.0	0.0	
Detector 1 Delay (s)	0.0	0.0		0.0	0.0		0.0	0.0		0.0	0.0	
Turn Type	Perm	NA		Perm	NA		Perm	NA		Perm	NA	
Protected Phases		6 14			2 10			4 12			4 12	
Permitted Phases	6 14			2 10			4 12			4 12		
Detector Phase	6 14	6 14		2 10	2 10		4 12	4 12		4 12	4 12	
Switch Phase												
Minimum Initial (s)												
Minimum Split (s)												
Total Split (s)												

Pepper Square TIA  
Lanes, Volumes, Timings

2021 - Existing - AM  
1335: Meadow Creek & Belt Line

Lane Group	Ø2	Ø4	Ø6	Ø10	Ø12	Ø14
Lane Configurations						
Traffic Volume (vph)						
Future Volume (vph)						
Ideal Flow (vphpl)						
Storage Length (ft)						
Storage Lanes						
Taper Length (ft)						
Lane Util. Factor						
Frt						
Flt Protected						
Satd. Flow (prot)						
Flt Permitted						
Satd. Flow (perm)						
Right Turn on Red						
Satd. Flow (RTOR)						
Link Speed (mph)						
Link Distance (ft)						
Travel Time (s)						
Peak Hour Factor						
Adj. Flow (vph)						
Shared Lane Traffic (%)						
Lane Group Flow (vph)						
Enter Blocked Intersection						
Lane Alignment						
Median Width(ft)						
Link Offset(ft)						
Crosswalk Width(ft)						
Two way Left Turn Lane						
Headway Factor						
Turning Speed (mph)						
Number of Detectors						
Detector Template						
Leading Detector (ft)						
Trailing Detector (ft)						
Detector 1 Position(ft)						
Detector 1 Size(ft)						
Detector 1 Type						
Detector 1 Channel						
Detector 1 Extend (s)						
Detector 1 Queue (s)						
Detector 1 Delay (s)						
Turn Type						
Protected Phases	2	4	6	10	12	14
Permitted Phases						
Detector Phase						
Switch Phase						
Minimum Initial (s)	12.0	6.0	12.0	12.0	12.0	6.0
Minimum Split (s)	17.0	23.5	17.0	20.0	23.0	20.0
Total Split (s)	96.0	22.0	96.0	22.0	20.0	22.0

Pepper Square TIA  
Lanes, Volumes, Timings

2021 - Existing - AM  
1335: Meadow Creek & Belt Line



Lane Group	EBL	EBT	EBR	WBL	WBT	WBR	NBL	NBT	NBR	SBL	SBT	SBR
Total Split (%)												
Maximum Green (s)												
Yellow Time (s)												
All-Red Time (s)												
Lost Time Adjust (s)												
Total Lost Time (s)												
Lead/Lag												
Lead-Lag Optimize?												
Vehicle Extension (s)												
Recall Mode												
Walk Time (s)												
Flash Dont Walk (s)												
Pedestrian Calls (#/hr)												
Act Effct Green (s)	122.2	122.2		122.2	122.2			21.8				21.8
Actuated g/C Ratio	0.76	0.76		0.76	0.76			0.14				0.14
v/c Ratio	0.09	0.16		0.01	0.29			0.17				0.35
Control Delay	3.2	2.7		0.3	0.3			39.7				15.6
Queue Delay	0.0	0.0		0.0	0.0			0.0				0.0
Total Delay	3.2	2.7		0.3	0.3			39.7				15.6
LOS	A	A		A	A			D				B
Approach Delay		2.7			0.3			39.7				15.6
Approach LOS		A			A			D				B
90th %ile Green (s)												
90th %ile Term Code												
70th %ile Green (s)												
70th %ile Term Code												
50th %ile Green (s)												
50th %ile Term Code												
30th %ile Green (s)												
30th %ile Term Code												
10th %ile Green (s)												
10th %ile Term Code												
Queue Length 50th (ft)	3	27		0	5			20				15
Queue Length 95th (ft)	8	32		m0	m4			47				63
Internal Link Dist (ft)		1593			2324			312				343
Turn Bay Length (ft)	150			150								
Base Capacity (vph)	338	4018		587	4025			283				411
Starvation Cap Reductn	0	0		0	0			0				0
Spillback Cap Reductn	0	0		0	0			0				0
Storage Cap Reductn	0	0		0	0			0				0
Reduced v/c Ratio	0.09	0.16		0.01	0.28			0.11				0.25

**Intersection Summary**  
 Area Type: Other  
 Cycle Length: 160  
 Actuated Cycle Length: 160  
 Offset: 82 (51%), Referenced to phase 2:WBTL and 6:EBTL, Start of Yellow  
 Natural Cycle: 85  
 Control Type: Actuated-Coordinated

Pepper Square TIA  
Lanes, Volumes, Timings

2021 - Existing - AM  
1335: Meadow Creek & Belt Line

Lane Group	Ø2	Ø4	Ø6	Ø10	Ø12	Ø14
Total Split (%)	60%	14%	60%	14%	13%	14%
Maximum Green (s)	91.0	16.5	91.0	17.0	15.0	16.5
Yellow Time (s)	4.0	3.7	4.0	4.0	4.0	3.7
All-Red Time (s)	1.0	1.8	1.0	1.0	1.0	1.8
Lost Time Adjust (s)						
Total Lost Time (s)						
Lead/Lag						
Lead-Lag Optimize?						
Vehicle Extension (s)	2.0	1.8	2.0	2.0	1.8	2.0
Recall Mode	C-Max	None	C-Min	None	None	None
Walk Time (s)	4.0	4.0	4.0	4.0	4.0	4.0
Flash Dont Walk (s)	8.0	14.0	8.0	8.0	14.0	8.0
Pedestrian Calls (#/hr)	0	0	0	0	0	0
Act Effct Green (s)						
Actuated g/C Ratio						
v/c Ratio						
Control Delay						
Queue Delay						
Total Delay						
LOS						
Approach Delay						
Approach LOS						
90th %ile Green (s)	103.5	10.5	103.5	13.5	12.0	13.0
90th %ile Term Code	Coord	Gap	Coord	Gap	Min	Hold
70th %ile Green (s)	107.8	7.7	107.8	12.0	12.0	11.5
70th %ile Term Code	Coord	Gap	Coord	Min	Min	Hold
50th %ile Green (s)	109.2	6.3	109.2	12.0	12.0	11.5
50th %ile Term Code	Coord	Gap	Coord	Min	Min	Hold
30th %ile Green (s)	109.5	6.0	109.5	12.0	12.0	11.5
30th %ile Term Code	Coord	Min	Coord	Min	Min	Hold
10th %ile Green (s)	109.5	6.0	109.5	12.0	12.0	11.5
10th %ile Term Code	Coord	Min	Coord	Min	Min	Hold
Queue Length 50th (ft)						
Queue Length 95th (ft)						
Internal Link Dist (ft)						
Turn Bay Length (ft)						
Base Capacity (vph)						
Starvation Cap Reductn						
Spillback Cap Reductn						
Storage Cap Reductn						
Reduced v/c Ratio						

**Intersection Summary**

Pepper Square TIA  
Lanes, Volumes, Timings

2021 - Existing - AM  
1335: Meadow Creek & Belt Line

Maximum v/c Ratio: 0.35	Intersection LOS: A
Intersection Signal Delay: 2.6	ICU Level of Service A
Intersection Capacity Utilization 37.8%	
Analysis Period (min) 15	
m Volume for 95th percentile queue is metered by upstream signal.	

Splits and Phases: 1335: Meadow Creek & Belt Line



Pepper Square TIA  
Lanes, Volumes, Timings

2021 - Existing - AM  
1365: Preston & Arapaho

Lane Group	EBU	EBL	EBT	EBR	WBL	WBT	WBR	NBU	NBL	NBT	NBR	SBU
Lane Configurations		↔↔	↔↔↔		↔↔	↔↔↔			↔↔	↔↔↔		
Traffic Volume (vph)	3	129	248	136	112	709	164	1	105	1618	79	4
Future Volume (vph)	3	129	248	136	112	709	164	1	105	1618	79	4
Ideal Flow (vphpl)	1900	1900	1900	1900	1900	1900	1900	1900	1900	1900	1900	1900
Storage Length (ft)		150		0	150		0		300		0	
Storage Lanes		2		0	2		0		2		0	
Taper Length (ft)		25			25				25			
Lane Util. Factor	0.91	0.97	0.91	0.91	0.97	0.91	0.91	0.91	0.97	0.91	0.91	0.91
Frt			0.947			0.972				0.993		
Flt Protected		0.950			0.950				0.950			
Satd. Flow (prot)	0	3433	4816	0	3433	4943	0	0	3433	5050	0	0
Flt Permitted		0.950			0.950				0.950			
Satd. Flow (perm)	0	3433	4816	0	3433	4943	0	0	3433	5050	0	0
Right Turn on Red			Yes				Yes				Yes	
Satd. Flow (RTOR)			83			33				6		
Link Speed (mph)			42			42				42		
Link Distance (ft)			1672			1942				3054		
Travel Time (s)			27.1			31.5				49.6		
Peak Hour Factor	0.95	0.95	0.95	0.95	0.95	0.95	0.95	0.95	0.95	0.95	0.95	0.95
Adj. Flow (vph)	3	136	261	143	118	746	173	1	111	1703	83	4
Shared Lane Traffic (%)												
Lane Group Flow (vph)	0	139	404	0	118	919	0	0	112	1786	0	0
Enter Blocked Intersection	No	No	No	No	No	No	No	No	No	No	No	No
Lane Alignment	R NA	Left	Left	Right	Left	Left	Right	R NA	Left	Left	Right	R NA
Median Width(ft)			24			24				24		
Link Offset(ft)			0			0				0		
Crosswalk Width(ft)			16			16				16		
Two way Left Turn Lane												
Headway Factor	1.00	1.00	1.00	1.00	1.00	1.00	1.00	1.00	1.00	1.00	1.00	1.00
Turning Speed (mph)	9	15		9	15		9	9	15		9	9
Number of Detectors	1	1	1		1	1		1	1	1		1
Detector Template												
Leading Detector (ft)	50	50	50		50	50		50	50	50		50
Trailing Detector (ft)	0	0	0		0	0		0	0	0		0
Detector 1 Position(ft)	0	0	0		0	0		0	0	0		0
Detector 1 Size(ft)	50	50	50		50	50		50	50	50		50
Detector 1 Type	Cl+Ex	Cl+Ex	Cl+Ex		Cl+Ex	Cl+Ex		Cl+Ex	Cl+Ex	Cl+Ex		Cl+Ex
Detector 1 Channel												
Detector 1 Extend (s)	0.0	0.0	0.0		0.0	0.0		0.0	0.0	0.0		0.0
Detector 1 Queue (s)	0.0	0.0	0.0		0.0	0.0		0.0	0.0	0.0		0.0
Detector 1 Delay (s)	0.0	0.0	0.0		0.0	0.0		0.0	0.0	0.0		0.0
Turn Type	Prot	Prot	NA		Prot	NA		Prot	Prot	NA		Prot
Protected Phases	3	3	8		7	4		1	1	6		5
Permitted Phases												
Detector Phase	3	3	8		7	4		1	1	6		5
Switch Phase												
Minimum Initial (s)	3.0	3.0	18.0		3.0	18.0		3.0	3.0	18.0		3.0
Minimum Split (s)	10.0	10.0	36.7		21.0	36.3		10.0	10.0	35.7		10.0
Total Split (s)	13.0	13.0	44.0		18.0	49.0		14.0	14.0	78.0		20.0

Pepper Square TIA  
Lanes, Volumes, Timings

2021 - Existing - AM  
1365: Preston & Arapaho

Lane Group	SBL	SBT	SBR
Lane Configurations			
Traffic Volume (vph)	98	1767	210
Future Volume (vph)	98	1767	210
Ideal Flow (vphpl)	1900	1900	1900
Storage Length (ft)	250		0
Storage Lanes	2		0
Taper Length (ft)	25		
Lane Util. Factor	0.97	0.91	0.91
Frt		0.984	
Flt Protected	0.950		
Satd. Flow (prot)	3433	5004	0
Flt Permitted	0.950		
Satd. Flow (perm)	3433	5004	0
Right Turn on Red			Yes
Satd. Flow (RTOR)		18	
Link Speed (mph)		48	
Link Distance (ft)		5087	
Travel Time (s)		72.3	
Peak Hour Factor	0.95	0.95	0.95
Adj. Flow (vph)	103	1860	221
Shared Lane Traffic (%)			
Lane Group Flow (vph)	107	2081	0
Enter Blocked Intersection	No	No	No
Lane Alignment	Left	Left	Right
Median Width(ft)		24	
Link Offset(ft)		0	
Crosswalk Width(ft)		16	
Two way Left Turn Lane			
Headway Factor	1.00	1.00	1.00
Turning Speed (mph)	15		9
Number of Detectors	1	1	
Detector Template			
Leading Detector (ft)	50	50	
Trailing Detector (ft)	0	0	
Detector 1 Position(ft)	0	0	
Detector 1 Size(ft)	50	50	
Detector 1 Type	Cl+Ex	Cl+Ex	
Detector 1 Channel			
Detector 1 Extend (s)	0.0	0.0	
Detector 1 Queue (s)	0.0	0.0	
Detector 1 Delay (s)	0.0	0.0	
Turn Type	Prot	NA	
Protected Phases	5	2	
Permitted Phases			
Detector Phase	5	2	
Switch Phase			
Minimum Initial (s)	3.0	18.0	
Minimum Split (s)	10.0	37.7	
Total Split (s)	20.0	84.0	

Pepper Square TIA  
Lanes, Volumes, Timings

2021 - Existing - AM  
1365: Preston & Arapaho

Lane Group	EBU	EBL	EBT	EBR	WBL	WBT	WBR	NBU	NBL	NBT	NBR	SBU
Total Split (%)	8.1%	8.1%	27.5%		11.3%	30.6%		8.8%	8.8%	48.8%		12.5%
Maximum Green (s)	7.5	7.5	38.7		12.5	43.7		8.5	8.5	72.3		14.5
Yellow Time (s)	3.0	3.0	4.3		3.0	4.3		3.0	3.0	4.7		3.0
All-Red Time (s)	2.5	2.5	1.0		2.5	1.0		2.5	2.5	1.0		2.5
Lost Time Adjust (s)		-1.0	-1.4		-1.0	-1.0				-1.0		-1.7
Total Lost Time (s)		4.5	3.9		4.5	4.3				4.5		4.0
Lead/Lag	Lead	Lead	Lag		Lead	Lag		Lead	Lead	Lead		Lag
Lead-Lag Optimize?	Yes	Yes	Yes		Yes	Yes		Yes	Yes	Yes		Yes
Vehicle Extension (s)	0.8	0.8	2.5		0.8	1.8		1.5	1.5	1.7		1.5
Recall Mode	None	None	Max		None	None		None	None	Max		None
Walk Time (s)			4.0			4.0				4.0		
Flash Dont Walk (s)			27.0			27.0				26.0		
Pedestrian Calls (#/hr)			0			0				0		
Act Effct Green (s)		8.3	43.9		9.7	44.9			8.9	74.0		
Actuated g/C Ratio		0.05	0.27		0.06	0.28			0.06	0.46		
v/c Ratio		0.78	0.29		0.56	0.65			0.59	0.76		
Control Delay		99.4	36.3		78.6	61.2			79.4	24.3		
Queue Delay		0.0	0.0		0.0	0.0			0.0	0.0		
Total Delay		99.4	36.3		78.6	61.2			79.4	24.3		
LOS		F	D		E	E			E	C		
Approach Delay			52.4			63.2				27.5		
Approach LOS			D			E				C		
90th %ile Green (s)	7.5	7.5	39.4		11.8	43.7		8.5	8.5	72.3		14.5
90th %ile Term Code	Max	Max	MaxR		Gap	Hold		Max	Max	Coord		Hold
70th %ile Green (s)	7.5	7.5	41.2		10.0	43.7		8.5	8.5	72.3		14.5
70th %ile Term Code	Max	Max	MaxR		Gap	Hold		Max	Max	Coord		Hold
50th %ile Green (s)	7.5	7.5	42.5		8.7	43.7		8.5	8.5	72.3		14.5
50th %ile Term Code	Max	Max	MaxR		Gap	Hold		Max	Max	Coord		Hold
30th %ile Green (s)	7.5	7.5	43.7		7.5	43.7		7.9	7.9	72.3		14.5
30th %ile Term Code	Max	Max	MaxR		Gap	Hold		Gap	Gap	Coord		Hold
10th %ile Green (s)	6.7	6.7	45.5		5.7	44.5		6.2	6.2	72.3		14.5
10th %ile Term Code	Gap	Gap	MaxR		Gap	Hold		Gap	Gap	Coord		Hold
Queue Length 50th (ft)		75	97		62	340			52	628		
Queue Length 95th (ft)		#133	131		98	401			m83	710		
Internal Link Dist (ft)			1592			1862				2974		
Turn Bay Length (ft)		150			150				300			
Base Capacity (vph)		182	1380		289	1409			203	2338		
Starvation Cap Reductn		0	0		0	0			0	0		
Spillback Cap Reductn		0	0		0	0			0	0		
Storage Cap Reductn		0	0		0	0			0	0		
Reduced v/c Ratio		0.76	0.29		0.41	0.65			0.55	0.76		
Intersection Summary												
Area Type:	Other											
Cycle Length:	160											
Actuated Cycle Length:	160											
Offset:	11 (7%), Referenced to phase 2:SBT, Start of Yellow											
Natural Cycle:	120											
Control Type:	Actuated-Coordinated											



Pepper Square TIA  
Lanes, Volumes, Timings

2021 - Existing - AM  
1365: Preston & Arapaho



Lane Group	SBL	SBT	SBR
Total Split (%)	12.5%	52.5%	
Maximum Green (s)	14.5	78.3	
Yellow Time (s)	3.0	4.7	
All-Red Time (s)	2.5	1.0	
Lost Time Adjust (s)	-1.0	-1.7	
Total Lost Time (s)	4.5	4.0	
Lead/Lag	Lag	Lag	
Lead-Lag Optimize?	Yes	Yes	
Vehicle Extension (s)	1.5	1.5	
Recall Mode	None	C-Max	
Walk Time (s)		4.0	
Flash Dont Walk (s)		28.0	
Pedestrian Calls (#/hr)		0	
Act Effct Green (s)	15.5	80.6	
Actuated g/C Ratio	0.10	0.50	
v/c Ratio	0.32	0.82	
Control Delay	79.0	44.2	
Queue Delay	0.0	0.0	
Total Delay	79.0	44.2	
LOS	E	D	
Approach Delay		45.9	
Approach LOS		D	
90th %ile Green (s)	14.5	78.3	
90th %ile Term Code	Hold	Coord	
70th %ile Green (s)	14.5	78.3	
70th %ile Term Code	Hold	Coord	
50th %ile Green (s)	14.5	78.3	
50th %ile Term Code	Hold	Coord	
30th %ile Green (s)	14.5	78.9	
30th %ile Term Code	Hold	Coord	
10th %ile Green (s)	14.5	80.6	
10th %ile Term Code	Hold	Coord	
Queue Length 50th (ft)	54	726	
Queue Length 95th (ft)	m68	817	
Internal Link Dist (ft)		5007	
Turn Bay Length (ft)	250		
Base Capacity (vph)	332	2529	
Starvation Cap Reductn	0	0	
Spillback Cap Reductn	0	0	
Storage Cap Reductn	0	0	
Reduced v/c Ratio	0.32	0.82	
<b>Intersection Summary</b>			

Pepper Square TIA  
Lanes, Volumes, Timings

2021 - Existing - AM  
1365: Preston & Arapaho

Maximum v/c Ratio: 0.82	Intersection LOS: D
Intersection Signal Delay: 43.5	ICU Level of Service D
Intersection Capacity Utilization 77.1%	
Analysis Period (min) 15	
# 95th percentile volume exceeds capacity, queue may be longer.	
Queue shown is maximum after two cycles.	
m Volume for 95th percentile queue is metered by upstream signal.	

Splits and Phases: 1365: Preston & Arapaho

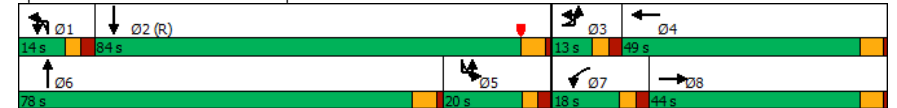

Pepper Square TIA  
Lanes, Volumes, Timings

2021 - Existing - AM  
1367: Preston & Belt Line

Lane Group	EBU	EBL	EBT	EBR	WBL	WBT	WBR	NBL	NBT	NBR	SBU	SBL
Lane Configurations		↔↔	↕↕↕	↔	↔	↕↕↕		↔↔	↕↕↕			↔
Traffic Volume (vph)	10	140	372	200	66	807	112	222	1502	21	2	121
Future Volume (vph)	10	140	372	200	66	807	112	222	1502	21	2	121
Ideal Flow (vphpl)	1900	1900	1900	1900	1900	1900	1900	1900	1900	1900	1900	1900
Storage Length (ft)		150		150	200		0	250		0		200
Storage Lanes		2		1	1		0	2		0		1
Taper Length (ft)		25			25			25				25
Lane Util. Factor	0.91	0.97	0.91	1.00	1.00	0.91	0.91	0.97	0.91	0.91	0.91	1.00
Fr				0.850		0.982			0.998			
Flt Protected		0.950			0.950			0.950				0.950
Satd. Flow (prot)	0	3433	5085	1583	1770	4994	0	3433	5075	0	0	1770
Flt Permitted		0.950			0.950			0.950				0.950
Satd. Flow (perm)	0	3433	5085	1583	1770	4994	0	3433	5075	0	0	1770
Right Turn on Red				Yes			Yes			Yes		
Satd. Flow (RTOR)				210		15			2			
Link Speed (mph)			42			42			42			
Link Distance (ft)			925			394			261			
Travel Time (s)			15.0			6.4			4.2			
Peak Hour Factor	0.95	0.95	0.95	0.95	0.95	0.95	0.95	0.95	0.95	0.95	0.95	0.95
Adj. Flow (vph)	11	147	392	211	69	849	118	234	1581	22	2	127
Shared Lane Traffic (%)												
Lane Group Flow (vph)	0	158	392	211	69	967	0	234	1603	0	0	129
Enter Blocked Intersection	No	No	No	No	No	No	No	No	No	No	No	No
Lane Alignment	R NA	Left	Left	Right	Left	Left	Right	Left	Left	Right	R NA	Left
Median Width(ft)			24			24			24			
Link Offset(ft)			0			0			0			
Crosswalk Width(ft)			16			16			16			
Two way Left Turn Lane												
Headway Factor	1.00	1.00	1.00	1.00	1.00	1.00	1.00	1.00	1.00	1.00	1.00	1.00
Turning Speed (mph)	9	15		9	15		9	15		9	9	15
Number of Detectors	1	1	1	1	1	1	1	1	1	1	1	1
Detector Template												
Leading Detector (ft)	50	50	50	50	50	50		50	50		50	50
Trailing Detector (ft)	0	0	0	0	0	0		0	0		0	0
Detector 1 Position(ft)	0	0	0	0	0	0		0	0		0	0
Detector 1 Size(ft)	50	50	50	50	50	50		50	50		50	50
Detector 1 Type	Cl+Ex	Cl+Ex	Cl+Ex	Cl+Ex	Cl+Ex	Cl+Ex		Cl+Ex	Cl+Ex		Cl+Ex	Cl+Ex
Detector 1 Channel												
Detector 1 Extnd (s)	0.0	0.0	0.0	0.0	0.0	0.0		0.0	0.0		0.0	0.0
Detector 1 Queue (s)	0.0	0.0	0.0	0.0	0.0	0.0		0.0	0.0		0.0	0.0
Detector 1 Delay (s)	0.0	0.0	0.0	0.0	0.0	0.0		0.0	0.0		0.0	0.0
Turn Type	Prot	Prot	NA	Perm	Prot	NA		Prot	NA		Prot	Prot
Protected Phases	3	3	8		7	4		1	6		5	5
Permitted Phases				8								
Detector Phase	3	3	8	8	7	4		1	6		5	5
Switch Phase												
Minimum Initial (s)	3.0	3.0	18.0	18.0	3.0	18.0		3.0	18.0		3.0	3.0
Minimum Split (s)	11.0	11.0	32.5	32.5	8.0	32.5		8.0	33.0		11.0	11.0
Total Split (s)	16.0	16.0	42.0	42.0	20.0	46.0		18.0	76.0		22.0	22.0

Pepper Square TIA  
Lanes, Volumes, Timings

2021 - Existing - AM  
1367: Preston & Belt Line

Lane Group	SBT	SBR
Lane Configurations	↕↕↕	↔
Traffic Volume (vph)	1685	226
Future Volume (vph)	1685	226
Ideal Flow (vphpl)	1900	1900
Storage Length (ft)		300
Storage Lanes		1
Taper Length (ft)		
Lane Util. Factor	0.91	1.00
Fr		0.850
Flt Protected		
Satd. Flow (prot)	5085	1583
Flt Permitted		
Satd. Flow (perm)	5085	1583
Right Turn on Red		Yes
Satd. Flow (RTOR)		186
Link Speed (mph)	40	
Link Distance (ft)	3054	
Travel Time (s)	52.1	
Peak Hour Factor	0.95	0.95
Adj. Flow (vph)	1774	238
Shared Lane Traffic (%)		
Lane Group Flow (vph)	1774	238
Enter Blocked Intersection	No	No
Lane Alignment	Left	Right
Median Width(ft)	24	
Link Offset(ft)	0	
Crosswalk Width(ft)	16	
Two way Left Turn Lane		
Headway Factor	1.00	1.00
Turning Speed (mph)	9	
Number of Detectors	1	1
Detector Template		
Leading Detector (ft)	50	50
Trailing Detector (ft)	0	0
Detector 1 Position(ft)	0	0
Detector 1 Size(ft)	50	50
Detector 1 Type	Cl+Ex	Cl+Ex
Detector 1 Channel		
Detector 1 Extnd (s)	0.0	0.0
Detector 1 Queue (s)	0.0	0.0
Detector 1 Delay (s)	0.0	0.0
Turn Type	NA	Perm
Protected Phases	2	
Permitted Phases		2
Detector Phase	2	2
Switch Phase		
Minimum Initial (s)	18.0	18.0
Minimum Split (s)	33.0	33.0
Total Split (s)	80.0	80.0

Pepper Square TIA  
Lanes, Volumes, Timings

2021 - Existing - AM  
1367: Preston & Belt Line

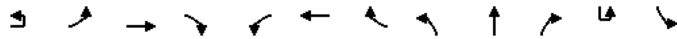

Lane Group	EBU	EBL	EBT	EBR	WBL	WBT	WBR	NBL	NBT	NBR	SBU	SBL
Total Split (%)	10.0%	10.0%	26.3%	26.3%	12.5%	28.8%		11.3%	47.5%		13.8%	13.8%
Maximum Green (s)	11.0	11.0	36.5	36.5	15.0	40.5		13.0	70.0		17.0	17.0
Yellow Time (s)	3.0	3.0	4.0	4.0	3.0	4.0		3.0	4.4		3.0	3.0
All-Red Time (s)	2.0	2.0	1.5	1.5	2.0	1.5		2.0	1.6		2.0	2.0
Lost Time Adjust (s)		-1.0	-1.5	-1.5	-1.0	-1.5		-1.0	-1.7			-1.0
Total Lost Time (s)		4.0	4.0	4.0	4.0	4.0		4.0	4.3			4.0
Lead/Lag	Lead	Lead	Lead	Lead	Lag	Lag		Lag	Lag		Lead	Lead
Lead-Lag Optimize?	Yes	Yes	Yes	Yes	Yes	Yes		Yes	Yes		Yes	Yes
Vehicle Extension (s)	1.3	1.3	1.3	1.3	1.0	1.3		1.6	2.0		1.5	1.5
Recall Mode	None	None	Max	Max	None	Max		None	C-Max		None	None
Walk Time (s)			7.0	7.0		7.0			7.0			
Flash Dont Walk (s)			20.0	20.0		20.0			20.0			
Pedestrian Calls (#/hr)			0	0		0			0			
Act Effct Green (s)		11.0	38.0	38.0	16.0	43.0		14.0	74.3			15.4
Actuated g/C Ratio		0.07	0.24	0.24	0.10	0.27		0.09	0.46			0.10
v/c Ratio		0.67	0.32	0.39	0.39	0.72		0.78	0.68			0.76
Control Delay		72.4	40.8	8.6	74.5	55.8		78.2	23.8			103.6
Queue Delay		0.0	0.0	0.0	0.0	0.0		0.0	0.6			0.0
Total Delay		72.4	40.8	8.6	74.5	55.8		78.2	24.5			103.6
LOS		E	D	A	E	E		E	C			F
Approach Delay			38.5			57.0			31.3			
Approach LOS			D			E			C			
90th %ile Green (s)	11.0	11.0	36.5	36.5	15.0	40.5		13.0	70.0		17.0	17.0
90th %ile Term Code	Max	Max	MaxR	MaxR	Hold	MaxR		Max	Coord		Max	Max
70th %ile Green (s)	11.0	11.0	36.5	36.5	15.0	40.5		13.0	70.0		17.0	17.0
70th %ile Term Code	Max	Max	MaxR	MaxR	Hold	MaxR		Max	Coord		Max	Max
50th %ile Green (s)	11.0	11.0	36.5	36.5	15.0	40.5		13.0	71.5		15.5	15.5
50th %ile Term Code	Max	Max	MaxR	MaxR	Hold	MaxR		Max	Coord		Gap	Gap
30th %ile Green (s)	9.6	9.6	36.5	36.5	15.0	41.9		13.0	74.0		13.0	13.0
30th %ile Term Code	Gap	Gap	MaxR	MaxR	Hold	MaxR		Max	Coord		Gap	Gap
10th %ile Green (s)	7.5	7.5	36.5	36.5	15.0	44.0		13.0	77.7		9.3	9.3
10th %ile Term Code	Gap	Gap	MaxR	MaxR	Hold	MaxR		Hold	Coord		Gap	Gap
Queue Length 50th (ft)		85	131	72	69	335		131	406			119
Queue Length 95th (ft)		126	168	115	125	391		#192	655			m157
Internal Link Dist (ft)			845			314			181			
Turn Bay Length (ft)		150		150	200			250				200
Base Capacity (vph)		257	1207	536	177	1352		300	2359			199
Starvation Cap Reductn		0	0	0	0	0		0	367			0
Spillback Cap Reductn		0	0	0	0	0		0	0			0
Storage Cap Reductn		0	0	0	0	0		0	0			0
Reduced v/c Ratio		0.61	0.32	0.39	0.39	0.72		0.78	0.80			0.65

**Intersection Summary**  
 Area Type: Other  
 Cycle Length: 160  
 Actuated Cycle Length: 160  
 Offset: 81 (51%), Referenced to phase 6:NBT, Start of Yellow  
 Natural Cycle: 90  
 Control Type: Actuated-Coordinated

Pepper Square TIA  
Lanes, Volumes, Timings

2021 - Existing - AM  
1367: Preston & Belt Line



Lane Group	SBT	SBR
Total Split (%)	50.0%	50.0%
Maximum Green (s)	74.0	74.0
Yellow Time (s)	4.4	4.4
All-Red Time (s)	1.6	1.6
Lost Time Adjust (s)	-1.7	-1.7
Total Lost Time (s)	4.3	4.3
Lead/Lag	Lead	Lead
Lead-Lag Optimize?	Yes	Yes
Vehicle Extension (s)	2.5	2.5
Recall Mode	Max	Max
Walk Time (s)	7.0	7.0
Flash Dont Walk (s)	20.0	20.0
Pedestrian Calls (#/hr)	0	0
Act Effct Green (s)	75.7	75.7
Actuated g/C Ratio	0.47	0.47
v/c Ratio	0.74	0.28
Control Delay	13.1	0.8
Queue Delay	0.0	0.0
Total Delay	13.1	0.8
LOS	B	A
Approach Delay	17.2	
Approach LOS	B	
90th %ile Green (s)	74.0	74.0
90th %ile Term Code	Coord	Coord
70th %ile Green (s)	74.0	74.0
70th %ile Term Code	Coord	Coord
50th %ile Green (s)	74.0	74.0
50th %ile Term Code	Coord	Coord
30th %ile Green (s)	74.0	74.0
30th %ile Term Code	Coord	Coord
10th %ile Green (s)	74.0	74.0
10th %ile Term Code	Coord	Coord
Queue Length 50th (ft)	279	0
Queue Length 95th (ft)	264	m2
Internal Link Dist (ft)	2974	
Turn Bay Length (ft)		300
Base Capacity (vph)	2405	846
Starvation Cap Reductn	0	0
Spillback Cap Reductn	0	0
Storage Cap Reductn	0	0
Reduced v/c Ratio	0.74	0.28

**Intersection Summary**

Pepper Square TIA  
Lanes, Volumes, Timings

2021 - Existing - AM  
1367: Preston & Belt Line

Maximum v/c Ratio: 0.78	Intersection LOS: C
Intersection Signal Delay: 31.6	ICU Level of Service D
Intersection Capacity Utilization 74.8%	
Analysis Period (min) 15	
# 95th percentile volume exceeds capacity, queue may be longer. Queue shown is maximum after two cycles.	
m Volume for 95th percentile queue is metered by upstream signal.	

Splits and Phases: 1367: Preston & Belt Line

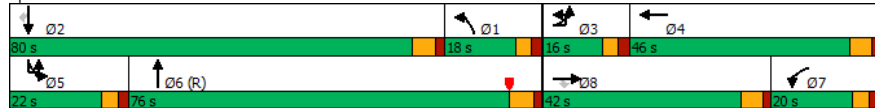

Pepper Square TIA  
Lanes, Volumes, Timings

2021 - Existing - AM  
1368: Preston & Alexis

Lane Group	EBL	EBT	EBR	WBL	WBT	WBR	NBU	NBL	NBT	NBR	SBL	SBT
Lane Configurations	↘	↕	↗	↘	↕	↗	↘	↕	↗	↘	↕	↗
Traffic Volume (vph)	15	5	27	126	21	35	3	20	1760	90	74	1836
Future Volume (vph)	15	5	27	126	21	35	3	20	1760	90	74	1836
Ideal Flow (vphpl)	1900	1900	1900	1900	1900	1900	1900	1900	1900	1900	1900	1900
Storage Length (ft)	0		0	175		0		150		150		150
Storage Lanes	1		1	2		1		1		1		1
Taper Length (ft)	25			25				25				25
Lane Util. Factor	0.91	0.91	1.00	0.97	1.00	1.00	0.91	1.00	0.91	1.00	1.00	0.91
Fr			0.850			0.850				0.850		
Flt Protected	0.950	0.970		0.950				0.950				0.950
Satd. Flow (prot)	1610	3288		1583		1863		1583		0	1770	5085
Flt Permitted	0.950	0.970		0.950				0.079				0.080
Satd. Flow (perm)	1610	3288		1583		1863		1583		0	147	5085
Right Turn on Red			Yes			Yes				Yes		Yes
Satd. Flow (RTOR)			125			85						89
Link Speed (mph)		30			30				43			42
Link Distance (ft)		660			627				2867			173
Travel Time (s)		15.0			14.3				45.5			2.8
Peak Hour Factor	0.92	0.92	0.92	0.92	0.92	0.92	0.92	0.92	0.92	0.92	0.92	0.92
Adj. Flow (vph)	16	5	29	137	23	38	3	22	1913	98	80	1996
Shared Lane Traffic (%)		50%										
Lane Group Flow (vph)	8	13	29	137	23	38	0	25	1913	98	80	1996
Enter Blocked Intersection	No	No	No	No	No	No	No	No	No	No	No	No
Lane Alignment	Left	Left	Right	Left	Left	Right	R NA	Left	Left	Right	Left	Left
Median Width(ft)		24			24				12			12
Link Offset(ft)		0			0				0			0
Crosswalk Width(ft)		16			16				16			16
Two way Left Turn Lane												
Headway Factor	1.00	1.00	1.00	1.00	1.00	1.00	1.00	1.00	1.00	1.00	1.00	1.00
Turning Speed (mph)	15		9	15		9	9	15		9	15	
Number of Detectors	1	1	1	1	1	1	1	1	1	1	1	1
Detector Template												
Leading Detector (ft)	50	50	50	50	50	50	50	50	50	50	50	50
Trailing Detector (ft)	0	0	0	0	0	0	0	0	0	0	0	0
Detector 1 Position(ft)	0	0	0	0	0	0	0	0	0	0	0	0
Detector 1 Size(ft)	50	50	50	50	50	50	50	50	50	50	50	50
Detector 1 Type	Cl+Ex	Cl+Ex	Cl+Ex	Cl+Ex	Cl+Ex	Cl+Ex	Cl+Ex	Cl+Ex	Cl+Ex	Cl+Ex	Cl+Ex	Cl+Ex
Detector 1 Channel												
Detector 1 Extnd (s)	0.0	0.0	0.0	0.0	0.0	0.0	0.0	0.0	0.0	0.0	0.0	0.0
Detector 1 Queue (s)	0.0	0.0	0.0	0.0	0.0	0.0	0.0	0.0	0.0	0.0	0.0	0.0
Detector 1 Delay (s)	0.0	0.0	0.0	0.0	0.0	0.0	0.0	0.0	0.0	0.0	0.0	0.0
Turn Type	Split	NA	Perm	Split	NA	pm+ov	custom	D.P+P	NA	Perm	D.P+P	NA
Protected Phases	3	3		4	4	5		1	6		5	2
Permitted Phases			3			4	1	2		6	6	
Detector Phase	3	3	3	4	4	5	1	1	6	6	5	2
Switch Phase												
Minimum Initial (s)	6.0	6.0	6.0	8.0	8.0	3.0	3.0	3.0	14.0	14.0	3.0	14.0
Minimum Split (s)	27.0	27.0	27.0	27.0	27.0	8.4	8.4	8.4	24.0	24.0	8.4	24.0
Total Split (s)	13.0	13.0	13.0	29.0	29.0	15.0	18.0	18.0	103.0	103.0	15.0	100.0

Pepper Square TIA  
Lanes, Volumes, Timings

2021 - Existing - AM  
1368: Preston & Alexis

Lane Group	SBR
Left-Through Configurations	7
Traffic Volume (vph)	22
Future Volume (vph)	22
Ideal Flow (vphpl)	1900
Storage Length (ft)	150
Storage Lanes	1
Taper Length (ft)	
Lane Util. Factor	1.00
Frt	0.850
Flt Protected	
Satd. Flow (prot)	1583
Flt Permitted	
Satd. Flow (perm)	1583
Right Turn on Red	Yes
Satd. Flow (RTOR)	78
Link Speed (mph)	
Link Distance (ft)	
Travel Time (s)	
Peak Hour Factor	0.92
Adj. Flow (vph)	24
Shared Lane Traffic (%)	
Lane Group Flow (vph)	24
Enter Blocked Intersection	No
Lane Alignment	Right
Median Width(ft)	
Link Offset(ft)	
Crosswalk Width(ft)	
Two way Left Turn Lane	
Headway Factor	1.00
Turning Speed (mph)	9
Number of Detectors	1
Detector Template	
Leading Detector (ft)	50
Trailing Detector (ft)	0
Detector 1 Position(ft)	0
Detector 1 Size(ft)	50
Detector 1 Type	Cl+Ex
Detector 1 Channel	
Detector 1 Extend (s)	0.0
Detector 1 Queue (s)	0.0
Detector 1 Delay (s)	0.0
Turn Type	Perm
Protected Phases	
Permitted Phases	2
Detector Phase	2
Switch Phase	
Minimum Initial (s)	14.0
Minimum Split (s)	24.0
Total Split (s)	100.0

Pepper Square TIA  
Lanes, Volumes, Timings

2021 - Existing - AM  
1368: Preston & Alexis

Lane Group	EBL	EBT	EBR	WBL	WBT	WBR	NBU	NBL	NBT	NBR	SBL	SBT
Total Split (%)	8.1%	8.1%	8.1%	18.1%	18.1%	9.4%	11.3%	11.3%	64.4%	64.4%	9.4%	62.5%
Maximum Green (s)	8.0	8.0	8.0	24.0	24.0	10.6	13.6	13.6	97.0	97.0	10.6	94.0
Yellow Time (s)	4.0	4.0	4.0	4.0	4.0	3.4	3.4	3.4	4.5	4.5	3.4	4.5
All-Red Time (s)	1.0	1.0	1.0	1.0	1.0	1.0	1.0	1.0	1.5	1.5	1.0	1.5
Lost Time Adjust (s)	-1.0	-1.0	0.0	-1.0	-1.0	0.0			-1.0	-2.0	0.0	-1.0
Total Lost Time (s)	4.0	4.0	5.0	4.0	4.0	4.4			3.4	4.0	6.0	3.4
Lead/Lag	Lead	Lead	Lead	Lag	Lag	Lag	Lead	Lead	Lead	Lead	Lag	Lag
Lead-Lag Optimize?	Yes	Yes	Yes	Yes	Yes	Yes	Yes	Yes	Yes	Yes	Yes	Yes
Vehicle Extension (s)	2.0	2.0	2.0	2.0	2.0	1.2	1.2	1.2	2.5	2.5	1.2	2.5
Recall Mode	None	None	None	None	None	None	None	None	Max	Max	None	C-Max
Walk Time (s)	4.0	4.0	4.0	4.0	4.0				4.0	4.0		4.0
Flash Dont Walk (s)	18.0	18.0	18.0	18.0	18.0				14.0	14.0		14.0
Pedestrian Calls (#/hr)	0	0	0	0	0				0	0		0
Act Effct Green (s)	7.2	7.2	6.2	11.9	11.9	23.0			129.7	116.1	114.1	128.3
Actuated g/C Ratio	0.04	0.04	0.04	0.07	0.07	0.14			0.81	0.73	0.71	0.80
v/c Ratio	0.11	0.09	0.16	0.54	0.17	0.13			0.15	0.52	0.08	0.34
Control Delay	76.7	74.5	1.9	79.0	71.0	0.9			3.4	4.7	0.2	10.9
Queue Delay	0.0	0.0	0.0	0.0	0.0	0.0			0.0	0.0	0.0	0.0
Total Delay	76.7	74.5	1.9	79.0	71.0	0.9			3.4	4.7	0.2	10.9
LOS	E	E	A	E	E	A			A	A	A	B
Approach Delay		32.7			63.1				4.4			1.4
Approach LOS		C			E				A			A
90th %ile Green (s)	6.9	6.9	6.9	14.1	14.1	10.6	4.8	4.8	108.0	108.0	10.6	113.8
90th %ile Term Code	Gap	Gap	Gap	Gap	Gap	Hold	Gap	Gap	Coord	Coord	Hold	Coord
70th %ile Green (s)	6.0	6.0	6.0	12.1	12.1	10.6	4.3	4.3	110.9	110.9	10.6	117.2
70th %ile Term Code	Min	Min	Min	Gap	Gap	Hold	Gap	Gap	Coord	Coord	Hold	Coord
50th %ile Green (s)	6.0	6.0	6.0	10.8	10.8	10.6	4.1	4.1	112.2	112.2	10.6	118.7
50th %ile Term Code	Min	Min	Min	Gap	Gap	Hold	Gap	Gap	Coord	Coord	Hold	Coord
30th %ile Green (s)	6.0	6.0	6.0	9.4	9.4	10.6	0.0	0.0	113.6	113.6	10.6	128.6
30th %ile Term Code	Min	Min	Min	Gap	Gap	Hold	Skip	Skip	Coord	Coord	Hold	Coord
10th %ile Green (s)	0.0	0.0	0.0	8.0	8.0	10.6	0.0	0.0	126.0	126.0	10.6	141.0
10th %ile Term Code	Skip	Skip	Skip	Min	Min	Hold	Skip	Skip	Coord	Coord	Hold	Coord
Queue Length 50th (ft)	8	7	0	72	23	0			2	120	1	9
Queue Length 95th (ft)	30	20	0	108	54	0			5	145	0	50
Internal Link Dist (ft)		580			547				2787			93
Turn Bay Length (ft)				175					150		150	
Base Capacity (vph)	90	184	197	536	291	299			269	3691	1154	237
Starvation Cap Reductn	0	0	0	0	0	0			0	0	0	223
Spillback Cap Reductn	0	0	0	0	0	0			0	0	0	0
Storage Cap Reductn	0	0	0	0	0	0			0	0	0	0
Reduced v/c Ratio	0.09	0.07	0.15	0.26	0.08	0.13			0.09	0.52	0.08	0.34

<b>Intersection Summary</b>	
Area Type:	Other
Cycle Length:	160
Actuated Cycle Length:	160
Offset:	89 (56%), Referenced to phase 2:NBSB, Start of Yellow
Natural Cycle:	100
Control Type:	Actuated-Coordinated

Pepper Square TIA  
Lanes, Volumes, Timings

2021 - Existing - AM  
1368: Preston & Alexis

Lane Group	SBR
Total Split (%)	62.5%
Maximum Green (s)	94.0
Yellow Time (s)	4.5
All-Red Time (s)	1.5
Lost Time Adjust (s)	0.0
Total Lost Time (s)	6.0
Lead/Lag	Lag
Lead-Lag Optimize?	Yes
Vehicle Extension (s)	2.5
Recall Mode	C-Max
Walk Time (s)	4.0
Flash Dont Walk (s)	14.0
Pedestrian Calls (#/hr)	0
Act Effct Green (s)	123.9
Actuated g/C Ratio	0.77
v/c Ratio	0.02
Control Delay	0.0
Queue Delay	0.0
Total Delay	0.0
LOS	A
Approach Delay	
Approach LOS	
90th %ile Green (s)	113.8
90th %ile Term Code	Coord
70th %ile Green (s)	117.2
70th %ile Term Code	Coord
50th %ile Green (s)	118.7
50th %ile Term Code	Coord
30th %ile Green (s)	128.6
30th %ile Term Code	Coord
10th %ile Green (s)	141.0
10th %ile Term Code	Coord
Queue Length 50th (ft)	0
Queue Length 95th (ft)	m0
Internal Link Dist (ft)	
Turn Bay Length (ft)	150
Base Capacity (vph)	1243
Starvation Cap Reductn	0
Spillback Cap Reductn	0
Storage Cap Reductn	0
Reduced v/c Ratio	0.02
Intersection Summary	

Pepper Square TIA  
Lanes, Volumes, Timings

2021 - Existing - AM  
1368: Preston & Alexis

Maximum v/c Ratio: 0.54	Intersection LOS: A
Intersection Signal Delay: 6.0	ICU Level of Service C
Intersection Capacity Utilization 64.6%	
Analysis Period (min) 15	
m Volume for 95th percentile queue is metered by upstream signal.	

Splits and Phases: 1368: Preston & Alexis

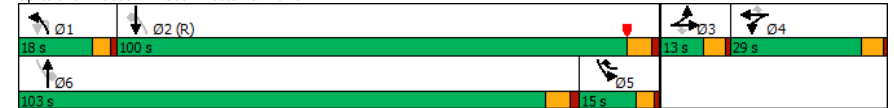

Pepper Square TIA  
Lanes, Volumes, Timings

2021 - Existing - AM  
1369: Preston & Belt Line Village Driveway



Lane Group	EBL	EBT	EBR	WBL	WBT	WBR	NBL	NBT	NBR	SBU	SBL	SBT
Lane Configurations		↔			↕		↔	↔↔↔				↔↔↔
Traffic Volume (vph)	39	1	27	4	2	0	24	1683	3	3	8	1949
Future Volume (vph)	39	1	27	4	2	0	24	1683	3	3	8	1949
Ideal Flow (vphpl)	1900	1900	1900	1900	1900	1900	1900	1900	1900	1900	1900	1900
Storage Length (ft)	0		0	0		0	100		0		100	
Storage Lanes	0		0	0		0	1		0		1	
Taper Length (ft)	25			25			25				25	
Lane Util. Factor	0.95	0.95	0.95	1.00	1.00	1.00	1.00	0.91	0.91	0.91	1.00	0.91
Frt		0.939										0.998
Flt Protected		0.972			0.968		0.950				0.950	
Satd. Flow (prot)	0	3230	0	0	1803	0	1770	5085	0	0	1770	5075
Flt Permitted		0.807			0.885		0.060				0.089	
Satd. Flow (perm)	0	2682	0	0	1649	0	112	5085	0	0	166	5075
Right Turn on Red			Yes			Yes			Yes			
Satd. Flow (RTOR)		30										2
Link Speed (mph)		30			30			42				38
Link Distance (ft)		303			249			252				191
Travel Time (s)		6.9			5.7			4.1				3.4
Peak Hour Factor	0.90	0.90	0.90	0.90	0.90	0.90	0.90	0.90	0.90	0.90	0.90	0.90
Adj. Flow (vph)	43	1	30	4	2	0	27	1870	3	3	9	2166
Shared Lane Traffic (%)												
Lane Group Flow (vph)	0	74	0	0	6	0	27	1873	0	0	12	2197
Enter Blocked Intersection	No	No	No	No	No	No	No	No	No	No	No	No
Lane Alignment	Left	Left	Right	Left	Left	Right	Left	Left	Right	R NA	Left	Left
Median Width(ft)		0			0			12				12
Link Offset(ft)		0			0			0				0
Crosswalk Width(ft)		16			16			16				16
Two way Left Turn Lane												
Headway Factor	1.00	1.00	1.00	1.00	1.00	1.00	1.00	1.00	1.00	1.00	1.00	1.00
Turning Speed (mph)	15		9	15		9	15		9	9	15	
Number of Detectors	1	1		1	1		1	1		1	1	1
Detector Template												
Leading Detector (ft)	50	50		50	50		50	50		50	50	50
Trailing Detector (ft)	0	0		0	0		0	0		0	0	0
Detector 1 Position(ft)	0	0		0	0		0	0		0	0	0
Detector 1 Size(ft)	50	50		50	50		50	50		50	50	50
Detector 1 Type	Cl+Ex	Cl+Ex		Cl+Ex	Cl+Ex		Cl+Ex	Cl+Ex		Cl+Ex	Cl+Ex	Cl+Ex
Detector 1 Channel												
Detector 1 Extend (s)	0.0	0.0		0.0	0.0		0.0	0.0		0.0	0.0	0.0
Detector 1 Queue (s)	0.0	0.0		0.0	0.0		0.0	0.0		0.0	0.0	0.0
Detector 1 Delay (s)	0.0	0.0		0.0	0.0		0.0	0.0		0.0	0.0	0.0
Turn Type	Perm	NA		Perm	NA		D.P+P	NA		custom	D.P+P	NA
Protected Phases		8			4		1	6			5	2
Permitted Phases		8			4		2			5	6	
Detector Phase		8	8		4	4	1	6		5	5	2
Switch Phase												
Minimum Initial (s)	20.0	20.0		20.0	20.0		5.0	20.0		5.0	5.0	20.0
Minimum Split (s)	25.0	25.0		25.0	25.0		10.0	26.0		10.0	10.0	26.0
Total Split (s)	47.0	47.0		47.0	47.0		20.0	98.0		15.0	15.0	93.0

Pepper Square TIA  
Lanes, Volumes, Timings

2021 - Existing - AM  
1369: Preston & Belt Line Village Driveway



Lane Group	SBR
Lane Configurations	↔
Traffic Volume (vph)	28
Future Volume (vph)	28
Ideal Flow (vphpl)	1900
Storage Length (ft)	0
Storage Lanes	0
Taper Length (ft)	
Lane Util. Factor	0.91
Frt	
Flt Protected	
Satd. Flow (prot)	0
Flt Permitted	
Satd. Flow (perm)	0
Right Turn on Red	Yes
Satd. Flow (RTOR)	
Link Speed (mph)	
Link Distance (ft)	
Travel Time (s)	
Peak Hour Factor	0.90
Adj. Flow (vph)	31
Shared Lane Traffic (%)	
Lane Group Flow (vph)	0
Enter Blocked Intersection	No
Lane Alignment	Right
Median Width(ft)	
Link Offset(ft)	
Crosswalk Width(ft)	
Two way Left Turn Lane	
Headway Factor	1.00
Turning Speed (mph)	9
Number of Detectors	
Detector Template	
Leading Detector (ft)	
Trailing Detector (ft)	
Detector 1 Position(ft)	
Detector 1 Size(ft)	
Detector 1 Type	
Detector 1 Channel	
Detector 1 Extend (s)	
Detector 1 Queue (s)	
Detector 1 Delay (s)	
Turn Type	
Protected Phases	
Permitted Phases	
Detector Phase	
Switch Phase	
Minimum Initial (s)	
Minimum Split (s)	
Total Split (s)	

Pepper Square TIA  
Lanes, Volumes, Timings

2021 - Existing - AM  
1369: Preston & Belt Line Village Driveway



Lane Group	EBL	EBT	EBR	WBL	WBT	WBR	NBL	NBT	NBR	SBU	SBL	SBT
Total Split (%)	29.4%	29.4%		29.4%	29.4%		12.5%	61.3%		9.4%	9.4%	58.1%
Maximum Green (s)	42.3	42.3		42.3	42.3		15.0	93.7		10.0	10.0	88.7
Yellow Time (s)	3.0	3.0		3.0	3.0		3.0	3.0		3.0	3.0	3.0
All-Red Time (s)	1.7	1.7		1.7	1.7		2.0	1.3		2.0	2.0	1.3
Lost Time Adjust (s)		-1.0			-1.0		-1.0	-2.0			-1.0	-2.0
Total Lost Time (s)		3.7			3.7		4.0	2.3			4.0	2.3
Lead/Lag							Lead	Lead		Lag	Lag	Lag
Lead-Lag Optimize?							Yes	Yes		Yes	Yes	Yes
Vehicle Extension (s)	2.0	2.0		2.0	2.0		1.5	3.0		1.5	1.5	3.3
Recall Mode	None	None		None	None		None	None		None	None	C-Max
Walk Time (s)	5.0	5.0		5.0	5.0		5.0	7.0		5.0	5.0	7.0
Flash Dont Walk (s)	15.0	15.0		15.0	15.0			8.0				8.0
Pedestrian Calls (#/hr)	0	0		0	0			0				0
Act Effct Green (s)		21.0			21.0		128.9	125.3			130.5	127.0
Actuated g/C Ratio		0.13			0.13		0.81	0.78			0.82	0.79
v/c Ratio		0.20			0.03		0.18	0.47			0.05	0.55
Control Delay		39.4			61.2		4.2	4.5			1.1	2.4
Queue Delay		0.0			0.0		0.0	0.0			0.0	0.1
Total Delay		39.4			61.2		4.2	4.5			1.1	2.5
LOS		D			E		A	A			A	A
Approach Delay		39.4			61.2			4.5				2.5
Approach LOS		D			E			A				A
90th %ile Green (s)	20.0	20.0		20.0	20.0		5.0	92.6		33.4	33.4	121.0
90th %ile Term Code	Min	Min		Min	Min		Min	Coord		Hold	Hold	Coord
70th %ile Green (s)	20.0	20.0		20.0	20.0		5.0	131.0		0.0	0.0	121.0
70th %ile Term Code	Min	Min		Hold	Hold		Min	Coord		Skip	Skip	Coord
50th %ile Green (s)	20.0	20.0		20.0	20.0		5.0	131.0		0.0	0.0	121.0
50th %ile Term Code	Min	Min		Hold	Hold		Min	Coord		Skip	Skip	Coord
30th %ile Green (s)	20.0	20.0		20.0	20.0		0.0	131.0		0.0	0.0	131.0
30th %ile Term Code	Min	Min		Hold	Hold		Skip	Coord		Skip	Skip	Coord
10th %ile Green (s)	20.0	20.0		20.0	20.0		0.0	131.0		0.0	0.0	131.0
10th %ile Term Code	Min	Min		Hold	Hold		Skip	Coord		Skip	Skip	Coord
Queue Length 50th (ft)		21			6		1	20			1	57
Queue Length 95th (ft)		48			22		m2	233			m1	61
Internal Link Dist (ft)		223			169			172				111
Turn Bay Length (ft)							100				100	
Base Capacity (vph)		747			446		257	3989			292	4028
Starvation Cap Reductn		0			0		0	139			0	333
Spillback Cap Reductn		0			0		0	172			0	0
Storage Cap Reductn		0			0		0	0			0	0
Reduced v/c Ratio		0.10			0.01		0.11	0.49			0.04	0.59

Intersection Summary	
Area Type:	Other
Cycle Length:	160
Actuated Cycle Length:	160
Offset:	86 (54%), Referenced to phase 2:NBSB, Start of Yellow
Natural Cycle:	65
Control Type:	Actuated-Coordinated

Pepper Square TIA  
Lanes, Volumes, Timings

2021 - Existing - AM  
1369: Preston & Belt Line Village Driveway



Lane Group	SBR
Total Split (%)	
Maximum Green (s)	
Yellow Time (s)	
All-Red Time (s)	
Lost Time Adjust (s)	
Total Lost Time (s)	
Lead/Lag	
Lead-Lag Optimize?	
Vehicle Extension (s)	
Recall Mode	
Walk Time (s)	
Flash Dont Walk (s)	
Pedestrian Calls (#/hr)	
Act Effct Green (s)	
Actuated g/C Ratio	
v/c Ratio	
Control Delay	
Queue Delay	
Total Delay	
LOS	
Approach Delay	
Approach LOS	
90th %ile Green (s)	
90th %ile Term Code	
70th %ile Green (s)	
70th %ile Term Code	
50th %ile Green (s)	
50th %ile Term Code	
30th %ile Green (s)	
30th %ile Term Code	
10th %ile Green (s)	
10th %ile Term Code	
Queue Length 50th (ft)	
Queue Length 95th (ft)	
Internal Link Dist (ft)	
Turn Bay Length (ft)	
Base Capacity (vph)	
Starvation Cap Reductn	
Spillback Cap Reductn	
Storage Cap Reductn	
Reduced v/c Ratio	

Intersection Summary	
Area Type:	
Cycle Length:	
Actuated Cycle Length:	
Offset:	
Natural Cycle:	
Control Type:	



Pepper Square TIA  
Lanes, Volumes, Timings

2021 - Existing - AM  
1369: Preston & Belt Line Village Driveway

Maximum v/c Ratio: 0.55	Intersection LOS: A
Intersection Signal Delay: 4.2	ICU Level of Service B
Intersection Capacity Utilization 61.6%	
Analysis Period (min) 15	
m Volume for 95th percentile queue is metered by upstream signal.	

Splits and Phases: 1369: Preston & Belt Line Village Driveway

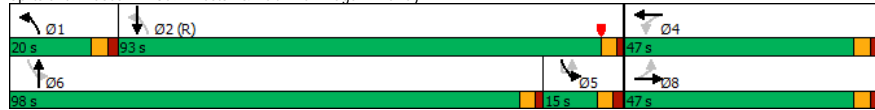

Pepper Square TIA  
Lanes, Volumes, Timings

2021 - Existing - AM  
1371: Preston & Spring Valley

Lane Group	EBL	EBT	EBR	WBL	WBT	WBR	NBL	NBT	NBR	SBU	SBL	SBT
Lane Configurations	↔↔	↑↑↑		↔↔	↑↑↑		↔↔	↑↑↑			↔↔	↑↑↑
Traffic Volume (vph)	139	353	244	87	711	140	111	1499	73	1	133	1882
Future Volume (vph)	139	353	244	87	711	140	111	1499	73	1	133	1882
Ideal Flow (vphpl)	1900	1900	1900	1900	1900	1900	1900	1900	1900	1900	1900	1900
Storage Length (ft)	225		0	225		0	225		0		275	
Storage Lanes	2		0	2		0	2		0		2	
Taper Length (ft)	25			25			25				25	
Lane Util. Factor	0.97	0.91	0.91	0.97	0.91	0.91	0.97	0.91	0.91	0.91	0.97	0.91
Frt		0.939			0.975			0.993				0.988
Flt Protected	0.950			0.950			0.950				0.950	
Satd. Flow (prot)	3433	4775	0	3433	4958	0	3433	5050	0	0	3433	5024
Flt Permitted	0.950			0.950			0.950				0.950	
Satd. Flow (perm)	3433	4775	0	3433	4958	0	3433	5050	0	0	3433	5024
Right Turn on Red			Yes			Yes			Yes			
Satd. Flow (RTOR)		104			24			6				13
Link Speed (mph)		38			42			41				38
Link Distance (ft)		3259			5488			2139				1208
Travel Time (s)		58.5			89.1			35.6				21.7
Peak Hour Factor	0.96	0.96	0.96	0.96	0.96	0.96	0.96	0.96	0.96	0.96	0.96	0.96
Adj. Flow (vph)	145	368	254	91	741	146	116	1561	76	1	139	1960
Shared Lane Traffic (%)												
Lane Group Flow (vph)	145	622	0	91	887	0	116	1637	0	0	140	2128
Enter Blocked Intersection	No	No	No	No	No	No	No	No	No	No	No	No
Lane Alignment	Left	Left	Right	Left	Left	Right	Left	Left	Right	R NA	Left	Left
Median Width(ft)		24			24			24				24
Link Offset(ft)		0			0			0				0
Crosswalk Width(ft)		16			16			16				16
Two way Left Turn Lane												
Headway Factor	1.00	1.00	1.00	1.00	1.00	1.00	1.00	1.00	1.00	1.00	1.00	1.00
Turning Speed (mph)	15		9	15		9	15		9	9	15	
Number of Detectors	1	1		1	1		1	1		1	1	1
Detector Template												
Leading Detector (ft)	50	50		50	50		50	50		50	50	50
Trailing Detector (ft)	0	0		0	0		0	0		0	0	0
Detector 1 Position(ft)	0	0		0	0		0	0		0	0	0
Detector 1 Size(ft)	50	50		50	50		50	50		50	50	50
Detector 1 Type	Cl+Ex	Cl+Ex		Cl+Ex	Cl+Ex		Cl+Ex	Cl+Ex		Cl+Ex	Cl+Ex	Cl+Ex
Detector 1 Channel												
Detector 1 Extend (s)	0.0	0.0		0.0	0.0		0.0	0.0		0.0	0.0	0.0
Detector 1 Queue (s)	0.0	0.0		0.0	0.0		0.0	0.0		0.0	0.0	0.0
Detector 1 Delay (s)	0.0	0.0		0.0	0.0		0.0	0.0		0.0	0.0	0.0
Turn Type	Prot	NA		Prot	NA		Prot	NA		Prot	Prot	NA
Protected Phases	3	8		7	4		1	6		5	5	2
Permitted Phases												
Detector Phase	3	8		7	4		1	6		5	5	2
Switch Phase												
Minimum Initial (s)	6.0	12.0		3.0	12.0		3.0	13.0		3.0	3.0	18.0
Minimum Split (s)	11.0	27.5		11.0	27.5		11.0	28.0		11.0	11.0	28.0
Total Split (s)	15.0	43.0		16.0	44.0		13.0	71.0		30.0	30.0	88.0

Pepper Square TIA  
Lanes, Volumes, Timings

2021 - Existing - AM  
1371: Preston & Spring Valley

Lane Group	SBR
Approach Configurations	
Traffic Volume (vph)	161
Future Volume (vph)	161
Ideal Flow (vphpl)	1900
Storage Length (ft)	0
Storage Lanes	0
Taper Length (ft)	
Lane Util. Factor	0.91
Fr	
Flt Protected	
Satd. Flow (prot)	0
Flt Permitted	
Satd. Flow (perm)	0
Right Turn on Red	Yes
Satd. Flow (RTOR)	
Link Speed (mph)	
Link Distance (ft)	
Travel Time (s)	
Peak Hour Factor	0.96
Adj. Flow (vph)	168
Shared Lane Traffic (%)	
Lane Group Flow (vph)	0
Enter Blocked Intersection	No
Lane Alignment	Right
Median Width(ft)	
Link Offset(ft)	
Crosswalk Width(ft)	
Two way Left Turn Lane	
Headway Factor	1.00
Turning Speed (mph)	9
Number of Detectors	
Detector Template	
Leading Detector (ft)	
Trailing Detector (ft)	
Detector 1 Position(ft)	
Detector 1 Size(ft)	
Detector 1 Type	
Detector 1 Channel	
Detector 1 Extend (s)	
Detector 1 Queue (s)	
Detector 1 Delay (s)	
Turn Type	
Protected Phases	
Permitted Phases	
Detector Phase	
Switch Phase	
Minimum Initial (s)	
Minimum Split (s)	
Total Split (s)	

Pepper Square TIA  
Lanes, Volumes, Timings

2021 - Existing - AM  
1371: Preston & Spring Valley

Lane Group	EBL	EBT	EBR	WBL	WBT	WBR	NBL	NBT	NBR	SBU	SBL	SBT
Total Split (%)	9.4%	26.9%		10.0%	27.5%		8.1%	44.4%		18.8%	18.8%	55.0%
Maximum Green (s)	10.0	37.5		11.0	38.5		8.0	65.0		25.0	25.0	82.0
Yellow Time (s)	3.0	4.0		3.0	4.0		3.0	4.5		3.0	3.0	4.5
All-Red Time (s)	2.0	1.5		2.0	1.5		2.0	1.5		2.0	2.0	1.5
Lost Time Adjust (s)	-1.0	-1.5		-1.0	-1.5		-1.0	-2.0			-1.0	-2.0
Total Lost Time (s)	4.0	4.0		4.0	4.0		4.0	4.0			4.0	4.0
Lead/Lag	Lead	Lead		Lag	Lag		Lead	Lead		Lag	Lag	Lag
Lead-Lag Optimize?	Yes	Yes		Yes	Yes		Yes	Yes		Yes	Yes	Yes
Vehicle Extension (s)	0.8	2.0		0.8	2.0		0.8	2.5		0.8	0.8	2.4
Recall Mode	None	None		None	None		None	None		None	None	C-Max
Walk Time (s)		4.0			4.0			4.0				4.0
Flash Dont Walk (s)		18.0			18.0			18.0				18.0
Pedestrian Calls (#/hr)		0			0			0				0
Act Effct Green (s)	10.0	23.7		20.4	34.1		8.9	64.9			34.9	91.0
Actuated g/C Ratio	0.06	0.15		0.13	0.21		0.06	0.41			0.22	0.57
v/c Ratio	0.67	0.78		0.21	0.83		0.61	0.80			0.19	0.74
Control Delay	79.6	58.2		62.9	59.6		90.1	51.4			65.8	38.6
Queue Delay	0.0	0.0		0.0	0.0		0.0	0.0			0.0	0.0
Total Delay	79.6	58.2		62.9	59.6		90.1	51.4			65.8	38.6
LOS	E	E		E	E		F	D			E	D
Approach Delay		62.3			59.9			53.9				40.3
Approach LOS		E			E			D				D
90th %ile Green (s)	10.0	27.4		21.1	38.5		8.0	65.0		25.0	25.0	82.0
90th %ile Term Code	Max	Gap		Hold	Max		Max	Coord		Hold	Hold	Coord
70th %ile Green (s)	10.0	24.3		21.2	35.5		9.9	64.0		29.0	29.0	83.1
70th %ile Term Code	Max	Gap		Hold	Gap		Coord	Coord		Hold	Hold	Coord
50th %ile Green (s)	10.0	22.2		20.2	32.4		8.6	62.5		33.6	33.6	87.5
50th %ile Term Code	Max	Gap		Hold	Gap		Coord	Coord		Hold	Hold	Coord
30th %ile Green (s)	8.6	20.1		18.5	30.0		7.4	62.0		37.9	37.9	92.5
30th %ile Term Code	Gap	Gap		Hold	Gap		Coord	Coord		Hold	Hold	Coord
10th %ile Green (s)	6.6	17.0		16.2	26.6		5.6	61.1		44.2	44.2	99.7
10th %ile Term Code	Gap	Gap		Hold	Gap		Coord	Coord		Hold	Hold	Coord
Queue Length 50th (ft)	76	208		47	336		64	482		71	71	767
Queue Length 95th (ft)	117	244		m44	m310		m100	461		m103	879	
Internal Link Dist (ft)		3179			5408			2059				1128
Turn Bay Length (ft)	225			225			225				275	
Base Capacity (vph)	236	1242		438	1257		203	2118			749	2861
Starvation Cap Reductn	0	0		0	0		0	0			0	0
Spillback Cap Reductn	0	0		0	0		0	0			0	0
Storage Cap Reductn	0	0		0	0		0	0			0	0
Reduced v/c Ratio	0.61	0.50		0.21	0.71		0.57	0.77			0.19	0.74
Intersection Summary												
Area Type:	Other											
Cycle Length:	160											
Actuated Cycle Length:	160											
Offset:	156 (98%), Referenced to phase 2:SBT, Start of Yellow											
Natural Cycle:	90											
Control Type:	Actuated-Coordinated											

Pepper Square TIA  
Lanes, Volumes, Timings

2021 - Existing - AM  
1371: Preston & Spring Valley

Lane Group	SBR
Total Split (%)	
Maximum Green (s)	
Yellow Time (s)	
All-Red Time (s)	
Lost Time Adjust (s)	
Total Lost Time (s)	
Lead/Lag	
Lead-Lag Optimize?	
Vehicle Extension (s)	
Recall Mode	
Walk Time (s)	
Flash Dont Walk (s)	
Pedestrian Calls (#/hr)	
Act Effect Green (s)	
Actuated g/C Ratio	
v/c Ratio	
Control Delay	
Queue Delay	
Total Delay	
LOS	
Approach Delay	
Approach LOS	
90th %ile Green (s)	
90th %ile Term Code	
70th %ile Green (s)	
70th %ile Term Code	
50th %ile Green (s)	
50th %ile Term Code	
30th %ile Green (s)	
30th %ile Term Code	
10th %ile Green (s)	
10th %ile Term Code	
Queue Length 50th (ft)	
Queue Length 95th (ft)	
Internal Link Dist (ft)	
Turn Bay Length (ft)	
Base Capacity (vph)	
Starvation Cap Reductn	
Spillback Cap Reductn	
Storage Cap Reductn	
Reduced v/c Ratio	
Intersection Summary	

Pepper Square TIA  
Lanes, Volumes, Timings

2021 - Existing - AM  
1371: Preston & Spring Valley

Maximum v/c Ratio: 0.83	
Intersection Signal Delay: 50.7	Intersection LOS: D
Intersection Capacity Utilization 78.5%	ICU Level of Service D
Analysis Period (min) 15	
m Volume for 95th percentile queue is metered by upstream signal.	

Splits and Phases: 1371: Preston & Spring Valley

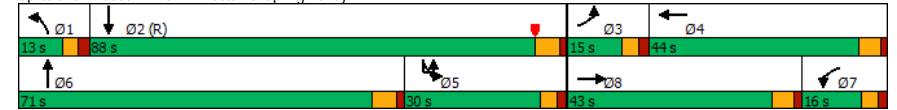

Pepper Square TIA  
Lanes, Volumes, Timings

2021 - Existing - AM  
1405: Prestonwood & Belt Line

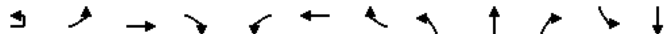

Lane Group	EBU	EBL	EBT	EBR	WBL	WBT	WBR	NBL	NBT	NBR	SBL	SBT
Lane Configurations		↖ ↗	↖ ↗		↖ ↗	↖ ↗			↕		↖ ↗	↖ ↗
Traffic Volume (vph)	4	40	695	3	4	1322	47	1	0	5	38	1
Future Volume (vph)	4	40	695	3	4	1322	47	1	0	5	38	1
Ideal Flow (vphpl)	1900	1900	1900	1900	1900	1900	1900	1900	1900	1900	1900	1900
Storage Length (ft)		200		0	200		0	0		0	300	
Storage Lanes		1		0	1		0	0		0	2	
Taper Length (ft)		25			25		25			25		
Lane Util. Factor	0.91	1.00	0.91	0.91	1.00	0.91	1.00	1.00	1.00	0.97	0.95	
Fr			0.999			0.995			0.887			0.855
Flt Protected		0.950			0.950				0.992		0.950	
Satd. Flow (prot)	0	1770	5080	0	1770	5060	0	0	1639	0	3433	1513
Flt Permitted		0.157			0.359				0.992		0.950	
Satd. Flow (perm)	0	292	5080	0	669	5060	0	0	1639	0	3433	1513
Right Turn on Red			Yes			Yes			Yes			
Satd. Flow (RTOR)			1			7			131			32
Link Speed (mph)			42			42			30			30
Link Distance (ft)			1445			2036			315			868
Travel Time (s)			23.5			33.1			7.2			19.7
Peak Hour Factor	0.95	0.95	0.95	0.95	0.95	0.95	0.95	0.95	0.95	0.95	0.95	0.95
Adj. Flow (vph)	4	42	732	3	4	1392	49	1	0	5	40	1
Shared Lane Traffic (%)												
Lane Group Flow (vph)	0	46	735	0	4	1441	0	0	6	0	40	33
Enter Blocked Intersection	No	No	No	No	No	No	No	No	No	No	No	No
Lane Alignment	R NA	Left	Left	Right	Left	Left	Right	Left	Left	Right	Left	Left
Median Width(ft)			24			24			24			24
Link Offset(ft)			0			0			0			0
Crosswalk Width(ft)			16			16			16			16
Two way Left Turn Lane												
Headway Factor	1.00	1.00	1.00	1.00	1.00	1.00	1.00	1.00	1.00	1.00	1.00	1.00
Turning Speed (mph)	9	15		9	15		9	15		9	15	
Number of Detectors	1	1	1		1	1		1	1		1	1
Detector Template												
Leading Detector (ft)	50	50	50		50	50		50	50		50	50
Trailing Detector (ft)	0	0	0		0	0		0	0		0	0
Detector 1 Position(ft)	0	0	0		0	0		0	0		0	0
Detector 1 Size(ft)	50	50	50		50	50		50	50		50	50
Detector 1 Type	Cl+Ex	Cl+Ex	Cl+Ex		Cl+Ex	Cl+Ex		Cl+Ex	Cl+Ex		Cl+Ex	Cl+Ex
Detector 1 Channel												
Detector 1 Extnd (s)	0.0	0.0	0.0		0.0	0.0		0.0	0.0		0.0	0.0
Detector 1 Queue (s)	0.0	0.0	0.0		0.0	0.0		0.0	0.0		0.0	0.0
Detector 1 Delay (s)	0.0	0.0	0.0		0.0	0.0		0.0	0.0		0.0	0.0
Turn Type	custom	D.P+P	NA		D.P+P	NA		Split	NA		Split	NA
Protected Phases		1	6		5	2		3	3		4	4
Permitted Phases		1	2		6							
Detector Phase		1	1	6		5	2		3	3		4
Switch Phase												
Minimum Initial (s)	3.0	3.0	15.0		3.0	15.0		5.0	5.0		7.0	7.0
Minimum Split (s)	8.0	8.0	22.0		8.0	24.0		23.0	23.0		23.2	23.2
Total Split (s)	15.0	15.0	109.0		15.0	109.0		18.0	18.0		18.0	18.0

Pepper Square TIA  
Lanes, Volumes, Timings

2021 - Existing - AM  
1405: Prestonwood & Belt Line



Lane Group	SBR
Lane Configurations	↖ ↗
Traffic Volume (vph)	62
Future Volume (vph)	62
Ideal Flow (vphpl)	1900
Storage Length (ft)	0
Storage Lanes	1
Taper Length (ft)	
Lane Util. Factor	0.95
Fr	0.850
Flt Protected	
Satd. Flow (prot)	1504
Flt Permitted	
Satd. Flow (perm)	1504
Right Turn on Red	Yes
Satd. Flow (RTOR)	89
Link Speed (mph)	
Link Distance (ft)	
Travel Time (s)	
Peak Hour Factor	0.95
Adj. Flow (vph)	65
Shared Lane Traffic (%)	49%
Lane Group Flow (vph)	33
Enter Blocked Intersection	No
Lane Alignment	Right
Median Width(ft)	
Link Offset(ft)	
Crosswalk Width(ft)	
Two way Left Turn Lane	
Headway Factor	1.00
Turning Speed (mph)	9
Number of Detectors	1
Detector Template	
Leading Detector (ft)	50
Trailing Detector (ft)	0
Detector 1 Position(ft)	0
Detector 1 Size(ft)	50
Detector 1 Type	Cl+Ex
Detector 1 Channel	
Detector 1 Extnd (s)	0.0
Detector 1 Queue (s)	0.0
Detector 1 Delay (s)	0.0
Turn Type	custom
Protected Phases	
Permitted Phases	1 4
Detector Phase	1 4
Switch Phase	
Minimum Initial (s)	
Minimum Split (s)	
Total Split (s)	

Pepper Square TIA  
Lanes, Volumes, Timings

2021 - Existing - AM  
1405: Prestonwood & Belt Line

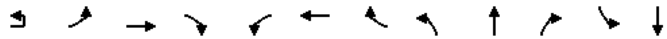

Lane Group	EBU	EBL	EBT	EBR	WBL	WBT	WBR	NBL	NBT	NBR	SBL	SBT
Total Split (%)	9.4%	9.4%	68.1%		9.4%	68.1%		11.3%	11.3%		11.3%	11.3%
Maximum Green (s)	10.0	10.0	103.0		10.0	103.0		13.0	13.0		12.8	12.8
Yellow Time (s)	3.0	3.0	4.5		3.0	4.5		3.0	3.0		3.2	3.2
All-Red Time (s)	2.0	2.0	1.5		2.0	1.5		2.0	2.0		2.0	2.0
Lost Time Adjust (s)		-1.0	-2.0		-1.0	-2.0		-1.0	-1.0		-1.2	-1.2
Total Lost Time (s)		4.0	4.0		4.0	4.0		4.0	4.0		4.0	4.0
Lead/Lag	Lag	Lag	Lag		Lead	Lead		Lead	Lead		Lag	Lag
Lead-Lag Optimize?	Yes	Yes	Yes		Yes	Yes		Yes	Yes		Yes	Yes
Vehicle Extension (s)	1.0	1.0	2.5		1.0	2.5		1.5	1.5		1.5	1.5
Recall Mode	None	None	C-Max		None	Max		None	None		None	None
Walk Time (s)			5.0			4.0			4.0			4.0
Flash Dont Walk (s)			10.0			14.0			14.0			14.0
Pedestrian Calls (#/hr)			0			0			0			0
Act Effct Green (s)		141.7	143.1		143.3	132.9			6.0		8.4	8.4
Actuated g/C Ratio		0.89	0.89		0.90	0.83			0.04		0.05	0.05
v/c Ratio		0.13	0.16		0.01	0.34			0.03		0.22	0.30
Control Delay		2.9	1.5		0.8	1.8			0.3		75.8	29.8
Queue Delay		0.0	0.0		0.0	0.0			0.0		0.0	0.0
Total Delay		2.9	1.5		0.8	1.8			0.3		75.8	29.8
LOS		A	A		A	A			A		E	C
Approach Delay			1.6			1.8			0.3			38.2
Approach LOS			A			A			A			D
90th %ile Green (s)	10.0	10.0	122.3		3.7	116.0		5.0	5.0		7.8	7.8
90th %ile Term Code	Hold	Hold	Coord		Gap	Coord		Min	Min		Gap	Gap
70th %ile Green (s)	10.0	10.0	141.8		0.0	126.8		0.0	0.0		7.0	7.0
70th %ile Term Code	Hold	Hold	Coord		Skip	Coord		Skip	Skip		Min	Min
50th %ile Green (s)	10.0	10.0	141.8		0.0	126.8		0.0	0.0		7.0	7.0
50th %ile Term Code	Hold	Hold	Coord		Skip	Coord		Skip	Skip		Min	Min
30th %ile Green (s)	10.0	10.0	141.8		0.0	126.8		0.0	0.0		7.0	7.0
30th %ile Term Code	Hold	Hold	Coord		Skip	Coord		Skip	Skip		Min	Min
10th %ile Green (s)	0.0	0.0	154.0		0.0	154.0		0.0	0.0		0.0	0.0
10th %ile Term Code	Skip	Skip	Coord		Skip	Coord		Skip	Skip		Skip	Skip
Queue Length 50th (ft)		3	19		0	49		0	0		21	1
Queue Length 95th (ft)		12	55		m1	70		0	0		42	41
Internal Link Dist (ft)			1365			1956			235			788
Turn Bay Length (ft)		200			200						300	
Base Capacity (vph)		358	4544		677	4203			262		300	161
Starvation Cap Reductn		0	0		0	0			0		0	0
Spillback Cap Reductn		0	0		0	0			0		0	0
Storage Cap Reductn		0	0		0	0			0		0	0
Reduced v/c Ratio		0.13	0.16		0.01	0.34			0.02		0.13	0.20

**Intersection Summary**  
 Area Type: Other  
 Cycle Length: 160  
 Actuated Cycle Length: 160  
 Offset: 73 (46%), Referenced to phase 6:EBWB, Start of Yellow  
 Natural Cycle: 80  
 Control Type: Actuated-Coordinated

Pepper Square TIA  
Lanes, Volumes, Timings

2021 - Existing - AM  
1405: Prestonwood & Belt Line



Lane Group	SBR
Total Split (%)	
Maximum Green (s)	
Yellow Time (s)	
All-Red Time (s)	
Lost Time Adjust (s)	
Total Lost Time (s)	
Lead/Lag	
Lead-Lag Optimize?	
Vehicle Extension (s)	
Recall Mode	
Walk Time (s)	
Flash Dont Walk (s)	
Pedestrian Calls (#/hr)	
Act Effct Green (s)	20.5
Actuated g/C Ratio	0.13
v/c Ratio	0.12
Control Delay	0.9
Queue Delay	0.0
Total Delay	0.9
LOS	A
Approach Delay	
Approach LOS	
90th %ile Green (s)	
90th %ile Term Code	
70th %ile Green (s)	
70th %ile Term Code	
50th %ile Green (s)	
50th %ile Term Code	
30th %ile Green (s)	
30th %ile Term Code	
10th %ile Green (s)	
10th %ile Term Code	
Queue Length 50th (ft)	0
Queue Length 95th (ft)	0
Internal Link Dist (ft)	
Turn Bay Length (ft)	
Base Capacity (vph)	338
Starvation Cap Reductn	0
Spillback Cap Reductn	0
Storage Cap Reductn	0
Reduced v/c Ratio	0.10

**Intersection Summary**

Pepper Square TIA  
Lanes, Volumes, Timings

2021 - Existing - AM  
1405: Prestonwood & Belt Line

Maximum v/c Ratio: 0.34	Intersection LOS: A
Intersection Signal Delay: 3.4	ICU Level of Service A
Intersection Capacity Utilization 50.8%	
Analysis Period (min) 15	
m Volume for 95th percentile queue is metered by upstream signal.	

Splits and Phases: 1405: Prestonwood & Belt Line



Pepper Square TIA  
HCM 6th TWSC

2021 - Existing - AM  
3: Median Opening East of Preston Rd & Belt Line

Intersection													
Int Delay, s/veh	0.4												
Movement	EBU	EBL	EBT	EBR	WBL	WBT	WBR	NBL	NBT	NBR	SBL	SBT	SBR
Lane Configurations		↑ ↑ ↑			↑ ↑ ↑			↔			↔		
Traffic Vol, veh/h	4	20	481	4	13	995	17	1	2	0	1	0	3
Future Vol, veh/h	4	20	481	4	13	995	17	1	2	0	1	0	3
Conflicting Peds, #/hr	0	0	0	0	0	0	0	0	0	0	0	0	0
Sign Control	Free	Free	Free	Free	Free	Free	Free	Stop	Stop	Stop	Stop	Stop	Stop
RT Channelized	-	-	-	None	-	None	-	-	None	-	-	None	-
Storage Length	-	150	-	-	200	-	-	-	-	-	-	-	-
Veh in Median Storage, #	-	-	0	-	-	0	-	-	1	-	-	1	-
Grade, %	-	-	0	-	-	0	-	-	0	-	-	0	-
Peak Hour Factor	96	96	96	96	96	96	96	96	96	96	96	96	96
Heavy Vehicles, %	2	2	2	2	2	2	2	2	2	2	2	2	2
Mvmt Flow	4	21	501	4	14	1036	18	1	2	0	1	0	3

Major/Minor	Major1		Major2		Minor1		Minor2						
Conflicting Flow All	770	1054	0	0	505	0	0	995	1635	253	1324	1628	527
Stage 1	-	-	-	-	-	-	-	553	553	-	1073	1073	-
Stage 2	-	-	-	-	-	-	-	442	1082	-	251	555	-
Critical Hdwy	5.64	5.34	-	-	5.34	-	-	6.44	6.54	7.14	6.44	6.54	7.14
Critical Hdwy Stg 1	-	-	-	-	-	-	-	7.34	5.54	-	7.34	5.54	-
Critical Hdwy Stg 2	-	-	-	-	-	-	-	6.74	5.54	-	6.74	5.54	-
Follow-up Hdwy	2.32	3.12	-	-	3.12	-	-	3.82	4.02	3.92	3.82	4.02	3.92
Pot Cap-1 Maneuver	589	369	-	-	674	-	-	257	100	636	164	101	424
Stage 1	-	-	-	-	-	-	-	403	513	-	177	295	-
Stage 2	-	-	-	-	-	-	-	516	292	-	671	511	-
Platoon blocked, %	-	-	-	-	-	-	-	-	-	-	-	-	-
Mov Cap-1 Maneuver	393	393	-	-	674	-	-	239	92	636	152	93	424
Mov Cap-2 Maneuver	-	-	-	-	-	-	-	298	191	-	151	202	-
Stage 1	-	-	-	-	-	-	-	377	480	-	166	289	-
Stage 2	-	-	-	-	-	-	-	502	286	-	626	478	-

Approach	EB	WB	NB	SB
HCM Control Delay, s	0.7	0.1	21.8	17.5
HCM LOS			C	C

Minor Lane/Major Mvmt	NBLn1	EBL	EBT	EBR	WBL	WBT	WBR	SBLn1
Capacity (veh/h)	217	393	-	-	674	-	-	292
HCM Lane V/C Ratio	0.014	0.064	-	-	0.02	-	-	0.014
HCM Control Delay (s)	21.8	14.8	-	-	10.5	-	-	17.5
HCM Lane LOS	C	B	-	-	B	-	-	C
HCM 95th %tile Q(veh)	0	0.2	-	-	0.1	-	-	0

Pepper Square TIA  
HCM 6th TWSC

2021 - Existing - AM  
4: Berry Trail & Belt Line

Intersection													
Int Delay, s/veh	1.9												
Movement	EBL	EBT	EBR	WBL	WBT	WBR	NBL	NBT	NBR	SBL	SBT	SBR	
Lane Configurations	↑ ↑ ↑			↑ ↑ ↑			↑	↑		↑	↑		
Traffic Vol, veh/h	13	464	4	3	970	21	1	1	0	34	7	61	
Future Vol, veh/h	13	464	4	3	970	21	1	1	0	34	7	61	
Conflicting Peds, #/hr	0	0	0	0	0	0	0	0	0	0	0	0	
Sign Control	Free	Free	Free	Free	Free	Free	Stop	Stop	Stop	Stop	Stop	Stop	
RT Channelized	-	-	None	-	None	-	-	None	-	-	None	-	
Storage Length	150	-	-	150	-	-	0	-	-	0	-	-	
Veh in Median Storage, #	-	0	-	-	0	-	-	1	-	-	1	-	
Grade, %	-	0	-	-	0	-	-	0	-	-	0	-	
Peak Hour Factor	85	85	85	85	85	85	85	85	85	85	85	85	
Heavy Vehicles, %	2	2	2	2	2	2	2	2	2	2	2	2	
Mvmt Flow	15	546	5	4	1141	25	1	1	0	40	8	72	

Major/Minor	Major1		Major2		Minor1		Minor2					
Conflicting Flow All	1166	0	0	551	0	0	1047	1753	276	1411	1743	583
Stage 1	-	-	-	-	-	-	579	579	-	1162	1162	-
Stage 2	-	-	-	-	-	-	468	1174	-	249	581	-
Critical Hdwy	5.34	-	-	5.34	-	-	6.44	6.54	7.14	6.44	6.54	7.14
Critical Hdwy Stg 1	-	-	-	-	-	-	7.34	5.54	-	7.34	5.54	-
Critical Hdwy Stg 2	-	-	-	-	-	-	6.74	5.54	-	6.74	5.54	-
Follow-up Hdwy	3.12	-	-	3.12	-	-	3.82	4.02	3.92	3.82	4.02	3.92
Pot Cap-1 Maneuver	325	-	-	641	-	-	240	84	615	146	86	390
Stage 1	-	-	-	-	-	-	387	499	-	153	267	-
Stage 2	-	-	-	-	-	-	498	264	-	673	498	-
Platoon blocked, %	-	-	-	-	-	-	-	-	-	-	-	-
Mov Cap-1 Maneuver	325	-	-	641	-	-	182	80	615	139	82	390
Mov Cap-2 Maneuver	-	-	-	-	-	-	253	180	-	133	188	-
Stage 1	-	-	-	-	-	-	369	476	-	146	265	-
Stage 2	-	-	-	-	-	-	391	262	-	640	475	-

Approach	EB	WB	NB	SB
HCM Control Delay, s	0.4	0	22.2	26.6
HCM LOS			C	D

Minor Lane/Major Mvmt	NBLn1	NBLn2	EBL	EBT	EBR	WBL	WBT	WBR	SBLn1	SBLn2
Capacity (veh/h)	253	180	325	-	-	641	-	-	133	351
HCM Lane V/C Ratio	0.005	0.007	0.047	-	-	0.006	-	-	0.301	0.228
HCM Control Delay (s)	19.3	25.1	16.6	-	-	10.6	-	-	43.3	18.3
HCM Lane LOS	C	D	C	-	-	B	-	-	E	C
HCM 95th %tile Q(veh)	0	0	0.1	-	-	0	-	-	1.2	0.9

Pepper Square TIA  
HCM 6th TWSC

2021 - Existing - AM  
5: Belt Line & Median between Berry Trail and Alexis Dr

Intersection												
Int Delay, s/veh	0.2											
Movement	EBL	EBT	EBR	WBL	WBT	WBR	NBL	NBT	NBR	SBL	SBT	SBR
Lane Configurations	↕ ↑↑↑			↕ ↑↑↑			↕			↕		
Traffic Vol, veh/h	5	515	0	11	991	11	1	0	0	6	1	7
Future Vol, veh/h	5	515	0	11	991	11	1	0	0	6	1	7
Conflicting Peds, #/hr	0	0	0	0	0	0	0	0	0	0	0	0
Sign Control	Free	Free	Free	Free	Free	Free	Stop	Stop	Stop	Stop	Stop	Stop
RT Channelized	-	-	None	-	-	None	-	-	None	-	-	None
Storage Length	150	-	-	150	-	-	-	-	-	-	-	-
Veh in Median Storage, #	-	0	-	-	0	-	-	1	-	-	1	-
Grade, %	-	0	-	-	0	-	-	0	-	-	0	-
Peak Hour Factor	88	88	88	88	88	88	88	88	88	88	88	88
Heavy Vehicles, %	2	2	2	2	2	2	2	2	2	2	2	2
Mvmt Flow	6	585	0	13	1126	13	1	0	0	7	1	8

Major/Minor	Major1	Major2	Minor1	Minor2
Conflicting Flow All	1139	0	0	585
Stage 1	-	-	-	-
Stage 2	-	-	-	-
Critical Hdwy	5.34	-	-	5.34
Critical Hdwy Stg 1	-	-	-	-
Critical Hdwy Stg 2	-	-	-	-
Follow-up Hdwy	3.12	-	-	3.12
Pot Cap-1 Maneuver	782	-	-	618
Stage 1	-	-	-	-
Stage 2	-	-	-	-
Platoon blocked, %	1	-	-	-
Mov Cap-1 Maneuver	782	-	-	618
Mov Cap-2 Maneuver	-	-	-	-
Stage 1	-	-	-	-
Stage 2	-	-	-	-

Approach	EB	WB	NB	SB
HCM Control Delay, s	0.1	0.1	10.7	11.9
HCM LOS			B	B

Minor Lane/Major Mvmt	NBLn1	EBL	EBT	EBR	WBL	WBT	WBR	SBLn1
Capacity (veh/h)	632	782	-	-	618	-	-	536
HCM Lane V/C Ratio	0.002	0.007	-	-	0.02	-	-	0.03
HCM Control Delay (s)	10.7	9.6	-	-	10.9	-	-	11.9
HCM Lane LOS	B	A	-	-	B	-	-	B
HCM 95th %tile Q(veh)	0	0	-	-	0.1	-	-	0.1

Notes  
 -: Volume exceeds capacity    \$: Delay exceeds 300s    +: Computation Not Defined    \*: All major volume in platoon

Pepper Square TIA  
HCM 6th TWSC

2021 - Existing - AM  
6: Alexis Drive & Belt Line

Intersection						
Int Delay, s/veh	1.9					
Movement	EBT	EBR	WBL	WBT	NBL	NBR
Lane Configurations	↑↑↑		↕ ↑↑↑		↕ ↕	
Traffic Vol, veh/h	518	3	145	997	2	107
Future Vol, veh/h	518	3	145	997	2	107
Conflicting Peds, #/hr	0	0	0	0	0	0
Sign Control	Free	Free	Free	Free	Stop	Stop
RT Channelized	-	None	-	None	-	Yield
Storage Length	-	-	150	-	0	0
Veh in Median Storage, #	0	-	-	0	1	-
Grade, %	0	-	-	0	0	-
Peak Hour Factor	86	86	86	86	86	86
Heavy Vehicles, %	2	2	2	2	2	2
Mvmt Flow	602	3	169	1159	2	124

Major/Minor	Major1	Major2	Minor1
Conflicting Flow All	0	0	605
Stage 1	-	-	-
Stage 2	-	-	-
Critical Hdwy	-	-	5.34
Critical Hdwy Stg 1	-	-	-
Critical Hdwy Stg 2	-	-	-
Follow-up Hdwy	-	-	3.12
Pot Cap-1 Maneuver	-	-	604
Stage 1	-	-	-
Stage 2	-	-	-
Platoon blocked, %	-	-	-
Mov Cap-1 Maneuver	-	-	604
Mov Cap-2 Maneuver	-	-	-
Stage 1	-	-	-
Stage 2	-	-	-

Approach	EB	WB	NB
HCM Control Delay, s	0	1.7	12.7
HCM LOS			B

Minor Lane/Major Mvmt	NBLn1	NBLn2	EBT	EBR	WBL	WBT
Capacity (veh/h)	350	591	-	-	604	-
HCM Lane V/C Ratio	0.007	0.211	-	-	0.279	-
HCM Control Delay (s)	15.4	12.7	-	-	13.3	-
HCM Lane LOS	C	B	-	-	B	-
HCM 95th %tile Q(veh)	0	0.8	-	-	1.1	-

Notes  
 -: Volume exceeds capacity    \$: Delay exceeds 300s    +: Computation Not Defined    \*: All major volume in platoon



Pepper Square TIA  
HCM 6th TWSC

2021 - Existing - AM  
10: Preston & Pepper Square Driveway

Intersection														
Int Delay, s/veh	1.1													
Movement	EBL	EBT	EBR	WBL	WBT	WBR	NBU	NBL	NBT	NBR	SBU	SBL	SBT	SBR
Lane Configurations	↔			↔				↑↑↑			↑↑↑			
Traffic Vol, veh/h	10	3	25	7	1	8	1	50	1725	18	1	15	1900	66
Future Vol, veh/h	10	3	25	7	1	8	1	50	1725	18	1	15	1900	66
Conflicting Peds, #/hr	0	0	0	0	0	0	0	0	0	0	0	0	0	0
Sign Control	Stop	Stop	Stop	Stop	Stop	Stop	Free	Free	Free	Free	Free	Free	Free	Free
RT Channelized	-	-	None	-	-	None	-	-	None	-	-	-	None	-
Storage Length	-	-	-	-	-	-	-	150	-	-	-	150	-	-
Veh in Median Storage, #	-	1	-	-	1	-	-	-	0	-	-	-	0	-
Grade, %	-	0	-	-	0	-	-	-	0	-	-	-	0	-
Peak Hour Factor	89	89	89	89	89	89	89	89	89	89	89	89	89	89
Heavy Vehicles, %	2	2	2	2	2	2	2	2	2	2	2	2	2	2
Mvmt Flow	11	3	28	8	1	9	1	56	1938	20	1	17	2135	74

Major/Minor	Minor2	Minor1	Major1	Major2										
Conflicting Flow All	3098	4280	1105	2954	4307	979	1613	2209	0	0	1430	1958	0	0
Stage 1	2208	2208	-	2062	2062	-	-	-	-	-	-	-	-	-
Stage 2	890	2072	-	892	2245	-	-	-	-	-	-	-	-	-
Critical Hdwy	6.44	6.54	7.14	6.44	6.54	7.14	5.64	5.34	-	-	5.64	5.34	-	-
Critical Hdwy Stg 1	7.34	5.54	-	7.34	5.54	-	-	-	-	-	-	-	-	-
Critical Hdwy Stg 2	6.74	5.54	-	6.74	5.54	-	-	-	-	-	-	-	-	-
Follow-up Hdwy	3.82	4.02	3.92	3.82	4.02	3.92	2.32	3.12	-	-	2.32	3.12	-	-
Pot Cap-1 Maneuver	44	-2	*477	*64	-1	214	*805	545	-	-	253	131	-	-
Stage 1	428	426	-	*35	96	-	-	-	-	-	-	-	-	-
Stage 2	275	95	-	*489	397	-	-	-	-	-	-	-	-	-
Platoon blocked, %	1	1	1	1	1	1	1	1	-	-	-	-	-	-
Mov Cap-1 Maneuver	34	-1	*477	*48	-1	214	*548	548	-	-	135	135	-	-
Mov Cap-2 Maneuver	140	52	-	*27	61	-	-	-	-	-	-	-	-	-
Stage 1	383	369	-	*31	86	-	-	-	-	-	-	-	-	-
Stage 2	233	85	-	*395	344	-	-	-	-	-	-	-	-	-

Approach	EB	WB	NB	SB
HCM Control Delay, s	26.6	110	0.4	0.3
HCM LOS	D	F		

Minor Lane/Major Mvmt	NBL	NBT	NBR	EBLn1	WBLn1	SBL	SBT	SBR
Capacity (veh/h)	548	-	-	209	51	135	-	-
HCM Lane V/C Ratio	0.105	-	-	0.204	0.353	0.133	-	-
HCM Control Delay (s)	12.3	-	-	26.6	110	35.7	-	-
HCM Lane LOS	B	-	-	D	F	E	-	-
HCM 95th %tile Q(veh)	0.3	-	-	0.7	1.3	0.4	-	-

Notes  
 -: Volume exceeds capacity    \$: Delay exceeds 300s    +: Computation Not Defined    \*: All major volume in platoon

Pepper Square TIA  
HCM 6th TWSC

2021 - Existing - AM  
20: Preston & Drive 2

Intersection						
Int Delay, s/veh	0					
Movement	WBL	WBR	NBT	NBR	SBL	SBT
Lane Configurations	↑↑↑				↑↑↑	
Traffic Vol, veh/h	0	2	1710	0	0	1987
Future Vol, veh/h	0	2	1710	0	0	1987
Conflicting Peds, #/hr	0	0	0	0	0	0
Sign Control	Stop	Stop	Free	Free	Free	Free
RT Channelized	-	None	-	None	-	None
Storage Length	-	0	-	-	-	-
Veh in Median Storage, #	0	-	0	-	-	0
Grade, %	0	-	0	-	-	0
Peak Hour Factor	92	92	92	92	92	92
Heavy Vehicles, %	2	2	2	2	2	2
Mvmt Flow	0	2	1859	0	0	2160

Major/Minor	Minor1	Major1	Major2				
Conflicting Flow All	-	930	0	0	-	-	-
Stage 1	-	-	-	-	-	-	-
Stage 2	-	-	-	-	-	-	-
Critical Hdwy	-	7.14	-	-	-	-	-
Critical Hdwy Stg 1	-	-	-	-	-	-	-
Critical Hdwy Stg 2	-	-	-	-	-	-	-
Follow-up Hdwy	-	3.92	-	-	-	-	-
Pot Cap-1 Maneuver	0	231	-	-	0	-	-
Stage 1	0	-	-	-	0	-	-
Stage 2	0	-	-	-	0	-	-
Platoon blocked, %	-	-	-	-	-	-	-
Mov Cap-1 Maneuver	-	231	-	-	-	-	-
Mov Cap-2 Maneuver	-	-	-	-	-	-	-
Stage 1	-	-	-	-	-	-	-
Stage 2	-	-	-	-	-	-	-

Approach	WB	NB	SB
HCM Control Delay, s	20.7	0	0
HCM LOS	C		

Minor Lane/Major Mvmt	NBT	NBR	WBLn1	SBT
Capacity (veh/h)	-	-	231	-
HCM Lane V/C Ratio	-	-	0.009	-
HCM Control Delay (s)	-	-	20.7	-
HCM Lane LOS	-	-	C	-
HCM 95th %tile Q(veh)	-	-	0	-

Pepper Square TIA  
HCM 6th TWSC

2021 - Existing - AM  
21: Preston & Drive 1

Intersection						
Int Delay, s/veh	0					
Movement	WBL	WBR	NBT	NBR	SBL	SBT
Lane Configurations		↗ ↘ ↘				↗ ↘ ↘
Traffic Vol, veh/h	0	0	1794	0	0	1931
Future Vol, veh/h	0	0	1794	0	0	1931
Conflicting Peds, #/hr	0	0	0	0	0	0
Sign Control	Stop	Stop	Free	Free	Free	Free
RT Channelized	-	None	-	None	-	None
Storage Length	-	0	-	-	-	-
Veh in Median Storage, #	0	-	0	-	-	0
Grade, %	0	-	0	-	-	0
Peak Hour Factor	92	92	92	92	92	92
Heavy Vehicles, %	2	2	2	2	2	2
Mvmt Flow	0	0	1950	0	0	2099

Major/Minor	Minor1	Major1	Major2		
Conflicting Flow All	-	975	0	0	-
Stage 1	-	-	-	-	-
Stage 2	-	-	-	-	-
Critical Hdwy	-	7.14	-	-	-
Critical Hdwy Stg 1	-	-	-	-	-
Critical Hdwy Stg 2	-	-	-	-	-
Follow-up Hdwy	-	3.92	-	-	-
Pot Cap-1 Maneuver	0	216	-	0	-
Stage 1	0	-	-	0	-
Stage 2	0	-	-	0	-
Platoon blocked, %	-	-	-	-	-
Mov Cap-1 Maneuver	-	216	-	-	-
Mov Cap-2 Maneuver	-	-	-	-	-
Stage 1	-	-	-	-	-
Stage 2	-	-	-	-	-

Approach	WB	NB	SB
HCM Control Delay, s	0	0	0
HCM LOS	A		

Minor Lane/Major Mvmt	NBT	NBRWBLn1	SBT
Capacity (veh/h)	-	-	-
HCM Lane V/C Ratio	-	-	-
HCM Control Delay (s)	-	0	-
HCM Lane LOS	-	A	-
HCM 95th %tile Q(veh)	-	-	-

Pepper Square TIA  
HCM 6th TWSC

2021 - Existing - AM  
22: Drive 6 & Belt Line

Intersection						
Int Delay, s/veh	0					
Movement	EBT	EBR	WBL	WBT	NBL	NBR
Lane Configurations	↗ ↘ ↘			↗ ↘ ↘		↗
Traffic Vol, veh/h	481	0	0	1031	0	0
Future Vol, veh/h	481	0	0	1031	0	0
Conflicting Peds, #/hr	0	0	0	0	0	0
Sign Control	Free	Free	Free	Free	Stop	Stop
RT Channelized	-	None	-	None	-	None
Storage Length	-	-	-	-	-	0
Veh in Median Storage, #	0	-	-	0	0	-
Grade, %	0	-	-	0	0	-
Peak Hour Factor	96	96	96	96	96	96
Heavy Vehicles, %	2	2	2	2	2	2
Mvmt Flow	501	0	0	1074	0	0

Major/Minor	Major1	Major2	Minor1		
Conflicting Flow All	0	0	-	-	251
Stage 1	-	-	-	-	-
Stage 2	-	-	-	-	-
Critical Hdwy	-	-	-	-	7.14
Critical Hdwy Stg 1	-	-	-	-	-
Critical Hdwy Stg 2	-	-	-	-	-
Follow-up Hdwy	-	-	-	-	3.92
Pot Cap-1 Maneuver	-	-	0	-	638
Stage 1	-	-	0	-	0
Stage 2	-	-	0	-	0
Platoon blocked, %	-	-	-	-	-
Mov Cap-1 Maneuver	-	-	-	-	638
Mov Cap-2 Maneuver	-	-	-	-	-
Stage 1	-	-	-	-	-
Stage 2	-	-	-	-	-

Approach	EB	WB	NB
HCM Control Delay, s	0	0	0
HCM LOS			A

Minor Lane/Major Mvmt	NBLn1	EBT	EBR	WBT
Capacity (veh/h)	-	-	-	-
HCM Lane V/C Ratio	-	-	-	-
HCM Control Delay (s)	0	-	-	-
HCM Lane LOS	A	-	-	-
HCM 95th %tile Q(veh)	-	-	-	-

Pepper Square TIA  
HCM 6th TWSC

2021 - Existing - AM  
23: Drive 7 & Belt Line

Intersection						
Int Delay, s/veh	0.1					
Movement	EBT	EBR	WBL	WBT	NBL	NBR
Lane Configurations	↑↑↑			↑↑↑		↑
Traffic Vol, veh/h	498	12	0	994	0	12
Future Vol, veh/h	498	12	0	994	0	12
Conflicting Peds, #/hr	0	0	0	0	0	0
Sign Control	Free	Free	Free	Free	Stop	Stop
RT Channelized	-	None	-	None	-	None
Storage Length	-	-	-	-	-	0
Veh in Median Storage, #	0	-	-	0	0	-
Grade, %	0	-	-	0	0	-
Peak Hour Factor	96	96	96	96	96	96
Heavy Vehicles, %	2	2	2	2	2	2
Mvmt Flow	519	13	0	1035	0	13

Major/Minor	Major1	Major2	Minor1
Conflicting Flow All	0	0	266
Stage 1	-	-	-
Stage 2	-	-	-
Critical Hdwy	-	-	7.14
Critical Hdwy Stg 1	-	-	-
Critical Hdwy Stg 2	-	-	-
Follow-up Hdwy	-	-	3.92
Pot Cap-1 Maneuver	-	0	624
Stage 1	-	0	0
Stage 2	-	0	0
Platoon blocked, %	-	-	-
Mov Cap-1 Maneuver	-	-	624
Mov Cap-2 Maneuver	-	-	-
Stage 1	-	-	-
Stage 2	-	-	-

Approach	EB	WB	NB
HCM Control Delay, s	0	0	10.9
HCM LOS			B

Minor Lane/Major Mvmt	NBLn1	EBT	EBR	WBT
Capacity (veh/h)	624	-	-	-
HCM Lane V/C Ratio	0.02	-	-	-
HCM Control Delay (s)	10.9	-	-	-
HCM Lane LOS	B	-	-	-
HCM 95th %tile Q(veh)	0.1	-	-	-

Pepper Square TIA  
HCM 6th TWSC

2021 - Existing - AM  
24: Drive 5 & Belt Line

Intersection						
Int Delay, s/veh	0					
Movement	EBT	EBR	WBL	WBT	NBL	NBR
Lane Configurations	↑↑↑			↑↑↑		↑
Traffic Vol, veh/h	510	0	0	984	0	0
Future Vol, veh/h	510	0	0	984	0	0
Conflicting Peds, #/hr	0	0	0	0	0	0
Sign Control	Free	Free	Free	Free	Stop	Stop
RT Channelized	-	None	-	None	-	None
Storage Length	-	-	-	-	-	0
Veh in Median Storage, #	0	-	-	0	0	-
Grade, %	0	-	-	0	0	-
Peak Hour Factor	96	96	96	96	96	96
Heavy Vehicles, %	2	2	2	2	2	2
Mvmt Flow	531	0	0	1025	0	0

Major/Minor	Major1	Major2	Minor1
Conflicting Flow All	0	0	266
Stage 1	-	-	-
Stage 2	-	-	-
Critical Hdwy	-	-	7.14
Critical Hdwy Stg 1	-	-	-
Critical Hdwy Stg 2	-	-	-
Follow-up Hdwy	-	-	3.92
Pot Cap-1 Maneuver	-	0	624
Stage 1	-	0	0
Stage 2	-	0	0
Platoon blocked, %	-	-	-
Mov Cap-1 Maneuver	-	-	624
Mov Cap-2 Maneuver	-	-	-
Stage 1	-	-	-
Stage 2	-	-	-

Approach	EB	WB	NB
HCM Control Delay, s	0	0	0
HCM LOS			A

Minor Lane/Major Mvmt	NBLn1	EBT	EBR	WBT
Capacity (veh/h)	-	-	-	-
HCM Lane V/C Ratio	-	-	-	-
HCM Control Delay (s)	0	-	-	-
HCM Lane LOS	A	-	-	-
HCM 95th %tile Q(veh)	-	-	-	-

Pepper Square TIA  
HCM 6th TWSC

2021 - Existing - AM  
25: Preston & Drive 4

Intersection						
Int Delay, s/veh	0					
Movement	WBL	WBR	NBT	NBR	SBL	SBT
Lane Configurations		↑ ↑ ↑				↑ ↑ ↑
Traffic Vol, veh/h	0	5	1745	3	0	1987
Future Vol, veh/h	0	5	1745	3	0	1987
Conflicting Peds, #/hr	0	0	0	0	0	0
Sign Control	Stop	Stop	Free	Free	Free	Free
RT Channelized	-	None	-	None	-	None
Storage Length	-	0	-	-	-	-
Veh in Median Storage, #	0	-	0	-	-	0
Grade, %	0	-	0	-	-	0
Peak Hour Factor	92	92	92	92	92	92
Heavy Vehicles, %	2	2	2	2	2	2
Mvmt Flow	0	5	1897	3	0	2160

Major/Minor	Minor1	Major1	Major2		
Conflicting Flow All	-	950	0	0	-
Stage 1	-	-	-	-	-
Stage 2	-	-	-	-	-
Critical Hdwy	-	7.14	-	-	-
Critical Hdwy Stg 1	-	-	-	-	-
Critical Hdwy Stg 2	-	-	-	-	-
Follow-up Hdwy	-	3.92	-	-	-
Pot Cap-1 Maneuver	0	224	-	0	-
Stage 1	0	-	-	0	-
Stage 2	0	-	-	0	-
Platoon blocked, %	-	-	-	-	-
Mov Cap-1 Maneuver	-	224	-	-	-
Mov Cap-2 Maneuver	-	-	-	-	-
Stage 1	-	-	-	-	-
Stage 2	-	-	-	-	-

Approach	WB	NB	SB
HCM Control Delay, s	21.5	0	0
HCM LOS	C		

Minor Lane/Major Mvmt	NBT	NBRWBLn1	SBT
Capacity (veh/h)	-	-	224
HCM Lane V/C Ratio	-	-	0.024
HCM Control Delay (s)	-	-	21.5
HCM Lane LOS	-	-	C
HCM 95th %tile Q(veh)	-	-	0.1

Pepper Square TIA  
HCM 6th TWSC

2021 - Existing - AM  
26: Preston & Drive 3

Intersection						
Int Delay, s/veh	0					
Movement	WBL	WBR	NBT	NBR	SBL	SBT
Lane Configurations		↑ ↑ ↑				↑ ↑ ↑
Traffic Vol, veh/h	0	3	1745	0	0	1987
Future Vol, veh/h	0	3	1745	0	0	1987
Conflicting Peds, #/hr	0	0	0	0	0	0
Sign Control	Stop	Stop	Free	Free	Free	Free
RT Channelized	-	None	-	None	-	None
Storage Length	-	0	-	-	-	-
Veh in Median Storage, #	0	-	0	-	-	0
Grade, %	0	-	0	-	-	0
Peak Hour Factor	92	92	92	92	92	92
Heavy Vehicles, %	2	2	2	2	2	2
Mvmt Flow	0	3	1897	0	0	2160

Major/Minor	Minor1	Major1	Major2		
Conflicting Flow All	-	949	0	0	-
Stage 1	-	-	-	-	-
Stage 2	-	-	-	-	-
Critical Hdwy	-	7.14	-	-	-
Critical Hdwy Stg 1	-	-	-	-	-
Critical Hdwy Stg 2	-	-	-	-	-
Follow-up Hdwy	-	3.92	-	-	-
Pot Cap-1 Maneuver	0	224	-	0	-
Stage 1	0	-	-	0	-
Stage 2	0	-	-	0	-
Platoon blocked, %	-	-	-	-	-
Mov Cap-1 Maneuver	-	224	-	-	-
Mov Cap-2 Maneuver	-	-	-	-	-
Stage 1	-	-	-	-	-
Stage 2	-	-	-	-	-

Approach	WB	NB	SB
HCM Control Delay, s	21.3	0	0
HCM LOS	C		

Minor Lane/Major Mvmt	NBT	NBRWBLn1	SBT
Capacity (veh/h)	-	-	224
HCM Lane V/C Ratio	-	-	0.015
HCM Control Delay (s)	-	-	21.3
HCM Lane LOS	-	-	C
HCM 95th %tile Q(veh)	-	-	0

Pepper Square TIA  
Lanes, Volumes, Timings

2021 - Existing - PM  
1335: Meadow Creek & Belt Line

	EBL	EBT	EBR	WBL	WBT	WBR	NBL	NBT	NBR	SBL	SBT	SBR
Lane Group	EBL	EBT	EBR	WBL	WBT	WBR	NBL	NBT	NBR	SBL	SBT	SBR
Lane Configurations	↔	↕↕↕		↔	↕↕↕			↕↕			↕↕	
Traffic Volume (vph)	86	1283	43	7	947	18	18	11	9	12	5	59
Future Volume (vph)	86	1283	43	7	947	18	18	11	9	12	5	59
Ideal Flow (vphpl)	1900	1900	1900	1900	1900	1900	1900	1900	1900	1900	1900	1900
Storage Length (ft)	150		0	150		0	0		0	0		0
Storage Lanes	1		0	1		0	0		0	0		0
Taper Length (ft)	25			25			25			25		
Lane Util. Factor	1.00	0.91	0.91	1.00	0.91	0.91	1.00	1.00	1.00	1.00	1.00	1.00
Frt		0.995			0.997			0.970			0.895	
Flt Protected	0.950			0.950				0.977			0.992	
Satd. Flow (prot)	1770	5060	0	1770	5070	0	0	1765	0	0	1654	0
Flt Permitted	0.269			0.177				0.536			0.944	
Satd. Flow (perm)	501	5060	0	330	5070	0	0	968	0	0	1574	0
Right Turn on Red		Yes			Yes			Yes			Yes	
Satd. Flow (RTOR)		6			4			9			62	
Link Speed (mph)		42			42			30			42	
Link Distance (ft)		1673			2404			392			423	
Travel Time (s)		27.2			39.0			8.9			9.6	
Peak Hour Factor	0.95	0.95	0.95	0.95	0.95	0.95	0.95	0.95	0.95	0.95	0.95	0.95
Adj. Flow (vph)	91	1351	45	7	997	19	19	12	9	13	5	62
Shared Lane Traffic (%)												
Lane Group Flow (vph)	91	1396	0	7	1016	0	0	40	0	0	80	0
Enter Blocked Intersection	No	No	No	No	No	No	No	No	No	No	No	No
Lane Alignment	Left	Left	Right	Left	Left	Right	Left	Left	Right	Left	Left	Right
Median Width(ft)		12			12			0			0	
Link Offset(ft)		0			0			0			0	
Crosswalk Width(ft)		16			16			16			16	
Two way Left Turn Lane												
Headway Factor	1.00	1.00	1.00	1.00	1.00	1.00	1.00	1.00	1.00	1.00	1.00	1.00
Turning Speed (mph)	15		9	15		9	15		9	15		9
Number of Detectors	1	1		1	1		1	1		1	1	1
Detector Template												
Leading Detector (ft)	50	50		50	50		50	50		50	50	
Trailing Detector (ft)	0	0		0	0		0	0		0	0	
Detector 1 Position(ft)	0	0		0	0		0	0		0	0	
Detector 1 Size(ft)	50	50		50	50		50	50		50	50	
Detector 1 Type	Cl+Ex	Cl+Ex		Cl+Ex	Cl+Ex		Cl+Ex	Cl+Ex		Cl+Ex	Cl+Ex	
Detector 1 Channel												
Detector 1 Extend (s)	0.0	0.0		0.0	0.0		0.0	0.0		0.0	0.0	
Detector 1 Queue (s)	0.0	0.0		0.0	0.0		0.0	0.0		0.0	0.0	
Detector 1 Delay (s)	0.0	0.0		0.0	0.0		0.0	0.0		0.0	0.0	
Turn Type	Perm	NA		Perm	NA		Perm	NA		Perm	NA	
Protected Phases		6			2			4			4	
Permitted Phases		6			2			4			4	
Detector Phase		6			2			4			4	
Switch Phase												
Minimum Initial (s)	12.0	12.0		12.0	12.0		6.0	6.0		6.0	6.0	
Minimum Split (s)	17.0	17.0		17.0	17.0		23.5	23.5		23.5	23.5	
Total Split (s)	110.0	110.0		110.0	110.0		50.0	50.0		50.0	50.0	

Pepper Square TIA  
Lanes, Volumes, Timings

2021 - Existing - PM  
1335: Meadow Creek & Belt Line

	EBL	EBT	EBR	WBL	WBT	WBR	NBL	NBT	NBR	SBL	SBT	SBR
Lane Group	EBL	EBT	EBR	WBL	WBT	WBR	NBL	NBT	NBR	SBL	SBT	SBR
Total Split (%)	68.8%	68.8%		68.8%	68.8%		31.3%	31.3%		31.3%	31.3%	
Maximum Green (s)	105.0	105.0		105.0	105.0		44.5	44.5		44.5	44.5	
Yellow Time (s)	4.0	4.0		4.0	4.0		3.7	3.7		3.7	3.7	
All-Red Time (s)	1.0	1.0		1.0	1.0		1.8	1.8		1.8	1.8	
Lost Time Adjust (s)	-1.0	-1.0		-1.0	-1.0			-1.5			-1.5	
Total Lost Time (s)	4.0	4.0		4.0	4.0			4.0			4.0	
Lead/Lag												
Lead-Lag Optimize?												
Vehicle Extension (s)	2.0	2.0		2.0	2.0		1.8	1.8		1.8	1.8	
Recall Mode	Min	Min		C-Max	C-Max		None	None		None	None	
Walk Time (s)	4.0	4.0		4.0	4.0		4.0	4.0		4.0	4.0	
Flash Dont Walk (s)	8.0	8.0		8.0	8.0		14.0	14.0		14.0	14.0	
Pedestrian Calls (#/hr)	0	0		0	0		0	0		0	0	
Act Effct Green (s)	142.5	142.5		142.5	142.5			9.5			9.5	
Actuated g/C Ratio	0.89	0.89		0.89	0.89			0.06			0.06	
v/c Ratio	0.20	0.31		0.02	0.23			0.62			0.53	
Control Delay	2.4	1.6		0.1	0.1			95.2			35.7	
Queue Delay	0.0	0.0		0.0	0.0			0.0			0.0	
Total Delay	2.4	1.6		0.1	0.1			95.2			35.7	
LOS	A	A		A	A			F			D	
Approach Delay		1.6			0.1			95.2			35.7	
Approach LOS		A			A			F			D	
90th %ile Green (s)	137.8	137.8		137.8	137.8		11.7	11.7		11.7	11.7	
90th %ile Term Code	Coord	Coord		Coord	Coord		Gap	Gap		Gap	Gap	
70th %ile Green (s)	140.5	140.5		140.5	140.5		9.0	9.0		9.0	9.0	
70th %ile Term Code	Coord	Coord		Coord	Coord		Gap	Gap		Gap	Gap	
50th %ile Green (s)	142.1	142.1		142.1	142.1		7.4	7.4		7.4	7.4	
50th %ile Term Code	Coord	Coord		Coord	Coord		Gap	Gap		Gap	Gap	
30th %ile Green (s)	143.5	143.5		143.5	143.5		6.0	6.0		6.0	6.0	
30th %ile Term Code	Coord	Coord		Coord	Coord		Min	Min		Min	Min	
10th %ile Green (s)	143.5	143.5		143.5	143.5		6.0	6.0		6.0	6.0	
10th %ile Term Code	Coord	Coord		Coord	Coord		Min	Min		Min	Min	
Queue Length 50th (ft)	8	53		0	3			32			18	
Queue Length 95th (ft)	22	83		m0	m4			75			75	
Internal Link Dist (ft)		1593			2324			312			343	
Turn Bay Length (ft)	150			150								
Base Capacity (vph)	446	4506		294	4515			284			496	
Starvation Cap Reductn	0	0		0	0			0			0	
Spillback Cap Reductn	0	0		0	0			0			0	
Storage Cap Reductn	0	0		0	0			0			0	
Reduced v/c Ratio	0.20	0.31		0.02	0.23			0.14			0.16	
Intersection Summary												
Area Type:	Other											
Cycle Length:	160											
Actuated Cycle Length:	160											
Offset:	73 (46%), Referenced to phase 2:WBTL, Start of Yellow											
Natural Cycle:	50											
Control Type:	Actuated-Coordinated											

Pepper Square TIA  
Lanes, Volumes, Timings

2021 - Existing - PM  
1335: Meadow Creek & Belt Line

Maximum v/c Ratio: 0.62	Intersection LOS: A
Intersection Signal Delay: 3.5	ICU Level of Service A
Intersection Capacity Utilization 50.8%	
Analysis Period (min) 15	
m Volume for 95th percentile queue is metered by upstream signal.	

Splits and Phases: 1335: Meadow Creek & Belt Line



Pepper Square TIA  
Lanes, Volumes, Timings

2021 - Existing - PM  
1365: Preston & Arapaho

Lane Group	EBU	EBL	EBT	EBR	WBL	WBT	WBR	NBU	NBL	NBT	NBR	SBU
Lane Configurations		↔↔	↕↕↕		↔↔	↕↕↕			↔↔	↕↕↕		
Traffic Volume (vph)	1	264	911	171	155	558	146	3	180	1715	196	5
Future Volume (vph)	1	264	911	171	155	558	146	3	180	1715	196	5
Ideal Flow (vphpl)	1900	1900	1900	1900	1900	1900	1900	1900	1900	1900	1900	1900
Storage Length (ft)		150		0	150		0		300		0	
Storage Lanes		2		0	2		0		2		0	
Taper Length (ft)		25			25				25			
Lane Util. Factor	0.91	0.97	0.91	0.91	0.97	0.91	0.91	0.91	0.97	0.91	0.91	0.91
Flt Protected		0.950			0.950				0.950			
Satd. Flow (prot)	0	3433	4963	0	3433	4928	0	0	3433	5009	0	0
Flt Permitted		0.950			0.950				0.950			
Satd. Flow (perm)	0	3433	4963	0	3433	4928	0	0	3433	5009	0	0
Right Turn on Red			Yes				Yes				Yes	
Satd. Flow (RTOR)			25			37				16		
Link Speed (mph)			42			42				42		
Link Distance (ft)			1672			1942				3054		
Travel Time (s)			27.1			31.5				49.6		
Peak Hour Factor	0.93	0.93	0.93	0.93	0.93	0.93	0.93	0.93	0.93	0.93	0.93	0.93
Adj. Flow (vph)	1	284	980	184	167	600	157	3	194	1844	211	5
Shared Lane Traffic (%)												
Lane Group Flow (vph)	0	285	1164	0	167	757	0	0	197	2055	0	0
Enter Blocked Intersection	No	No	No	No	No	No	No	No	No	No	No	No
Lane Alignment	R NA	Left	Left	Right	Left	Left	Right	R NA	Left	Left	Right	R NA
Median Width(ft)			24			24				24		
Link Offset(ft)			0			0				0		
Crosswalk Width(ft)			16			16				16		
Two way Left Turn Lane												
Headway Factor	1.00	1.00	1.00	1.00	1.00	1.00	1.00	1.00	1.00	1.00	1.00	1.00
Turning Speed (mph)	9	15		9	15		9	9	15		9	9
Number of Detectors	1	1	1		1	1		1	1	1		1
Detector Template												
Leading Detector (ft)	50	50	50		50	50		50	50	50		50
Trailing Detector (ft)	0	0	0		0	0		0	0	0		0
Detector 1 Position(ft)	0	0	0		0	0		0	0	0		0
Detector 1 Size(ft)	50	50	50		50	50		50	50	50		50
Detector 1 Type	Cl+Ex	Cl+Ex	Cl+Ex		Cl+Ex	Cl+Ex		Cl+Ex	Cl+Ex	Cl+Ex		Cl+Ex
Detector 1 Channel												
Detector 1 Extnd (s)	0.0	0.0	0.0		0.0	0.0		0.0	0.0	0.0		0.0
Detector 1 Queue (s)	0.0	0.0	0.0		0.0	0.0		0.0	0.0	0.0		0.0
Detector 1 Delay (s)	0.0	0.0	0.0		0.0	0.0		0.0	0.0	0.0		0.0
Turn Type	Prot	Prot	NA		Prot	NA		Prot	Prot	NA		Prot
Protected Phases	3	3	8		7	4		1	1	6		5
Permitted Phases												
Detector Phase	3	3	8		7	4		1	1	6		5
Switch Phase												
Minimum Initial (s)	3.0	3.0	18.0		3.0	18.0		3.0	3.0	18.0		3.0
Minimum Split (s)	10.0	10.0	36.7		21.0	36.3		10.0	10.0	35.7		10.0
Total Split (s)	30.0	30.0	53.0		13.0	36.0		24.0	24.0	76.0		18.0

Pepper Square TIA  
Lanes, Volumes, Timings

2021 - Existing - PM  
1365: Preston & Arapaho



Lane Group	SBL	SBT	SBR
Lane Configurations	↔	↑↑↓	↔
Traffic Volume (vph)	208	1323	177
Future Volume (vph)	208	1323	177
Ideal Flow (vphpl)	1900	1900	1900
Storage Length (ft)	250		0
Storage Lanes	2		0
Taper Length (ft)	25		
Lane Util. Factor	0.97	0.91	0.91
Frt		0.982	
Flt Protected	0.950		
Satd. Flow (prot)	3433	4994	0
Flt Permitted	0.950		
Satd. Flow (perm)	3433	4994	0
Right Turn on Red			Yes
Satd. Flow (RTOR)		18	
Link Speed (mph)		48	
Link Distance (ft)		5087	
Travel Time (s)		72.3	
Peak Hour Factor	0.93	0.93	0.93
Adj. Flow (vph)	224	1423	190
Shared Lane Traffic (%)			
Lane Group Flow (vph)	229	1613	0
Enter Blocked Intersection	No	No	No
Lane Alignment	Left	Left	Right
Median Width(ft)		24	
Link Offset(ft)		0	
Crosswalk Width(ft)		16	
Two way Left Turn Lane			
Headway Factor	1.00	1.00	1.00
Turning Speed (mph)	15		9
Number of Detectors	1	1	
Detector Template			
Leading Detector (ft)	50	50	
Trailing Detector (ft)	0	0	
Detector 1 Position(ft)	0	0	
Detector 1 Size(ft)	50	50	
Detector 1 Type	Cl+Ex	Cl+Ex	
Detector 1 Channel			
Detector 1 Extend (s)	0.0	0.0	
Detector 1 Queue (s)	0.0	0.0	
Detector 1 Delay (s)	0.0	0.0	
Turn Type	Prot	NA	
Protected Phases	5	2	
Permitted Phases			
Detector Phase	5	2	
Switch Phase			
Minimum Initial (s)	3.0	18.0	
Minimum Split (s)	10.0	37.7	
Total Split (s)	18.0	70.0	

Pepper Square TIA  
Lanes, Volumes, Timings

2021 - Existing - PM  
1365: Preston & Arapaho

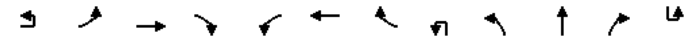

Lane Group	EBU	EBL	EBT	EBR	WBL	WBT	WBR	NBU	NBL	NBT	NBR	SBU
Total Split (%)	18.8%	18.8%	33.1%		8.1%	22.5%		15.0%	15.0%	47.5%		11.3%
Maximum Green (s)	24.5	24.5	47.7		7.5	30.7		18.5	18.5	70.3		12.5
Yellow Time (s)	3.0	3.0	4.3		3.0	4.3		3.0	3.0	4.7		3.0
All-Red Time (s)	2.5	2.5	1.0		2.5	1.0		2.5	2.5	1.0		2.5
Lost Time Adjust (s)		-1.0	-1.4		-1.0	-1.0			-1.0	-1.7		
Total Lost Time (s)		4.5	3.9		4.5	4.3			4.5	4.0		
Lead/Lag	Lead	Lead	Lead		Lag	Lag		Lead	Lead	Lead		Lag
Lead-Lag Optimize?	Yes	Yes	Yes		Yes	Yes		Yes	Yes	Yes		Yes
Vehicle Extension (s)	0.8	0.8	2.5		0.8	1.8		1.5	1.5	1.7		1.5
Recall Mode	None	None	Max		None	None		None	None	Max		None
Walk Time (s)			4.0			4.0				4.0		
Flash Dont Walk (s)			27.0			27.0				26.0		
Pedestrian Calls (#/hr)			0			0				0		
Act Effct Green (s)		17.5	49.1		8.5	39.7			14.1	72.0		
Actuated g/C Ratio		0.11	0.31		0.05	0.25			0.09	0.45		
v/c Ratio		0.76	0.76		0.92	0.61			0.65	0.91		
Control Delay		81.4	51.9		113.8	48.6			97.8	25.0		
Queue Delay		0.0	0.0		0.0	0.0			0.0	0.0		
Total Delay		81.4	51.9		113.8	48.6			97.8	25.0		
LOS		F	D		F	D			F	C		
Approach Delay			57.7			60.3				31.3		
Approach LOS			E			E				C		
90th %ile Green (s)	21.3	21.3	47.7		7.5	33.9		17.0	17.0	70.3		12.5
90th %ile Term Code	Gap	Gap	MaxR		Max	Hold		Gap	Gap	Coord		Max
70th %ile Green (s)	18.5	18.5	47.7		7.5	36.7		14.7	14.7	70.3		12.5
70th %ile Term Code	Gap	Gap	MaxR		Max	Hold		Gap	Gap	Coord		Max
50th %ile Green (s)	16.5	16.5	47.7		7.5	38.7		13.1	13.1	70.3		12.5
50th %ile Term Code	Gap	Gap	MaxR		Max	Hold		Gap	Gap	Coord		Max
30th %ile Green (s)	14.6	14.6	47.7		7.5	40.6		11.4	11.4	70.3		12.5
30th %ile Term Code	Gap	Gap	MaxR		Max	Hold		Gap	Gap	Coord		Max
10th %ile Green (s)	11.7	11.7	47.7		7.5	43.5		9.1	9.1	70.3		12.5
10th %ile Term Code	Gap	Gap	MaxR		Max	Hold		Gap	Gap	Coord		Hold
Queue Length 50th (ft)		152	396		92	228			95	174		
Queue Length 95th (ft)		198	454		#168	260			m116	m183		
Internal Link Dist (ft)			1592			1862				2974		
Turn Bay Length (ft)		150			150				300			
Base Capacity (vph)		547	1540		182	1249			418	2262		
Starvation Cap Reductn		0	0		0	0			0	0		
Spillback Cap Reductn		0	0		0	0			0	0		
Storage Cap Reductn		0	0		0	0			0	0		
Reduced v/c Ratio		0.52	0.76		0.92	0.61			0.47	0.91		

Intersection Summary

Area Type: Other  
 Cycle Length: 160  
 Actuated Cycle Length: 160  
 Offset: 120 (75%), Referenced to phase 2:SBT, Start of Yellow  
 Natural Cycle: 120  
 Control Type: Actuated-Coordinated

Pepper Square TIA  
Lanes, Volumes, Timings

2021 - Existing - PM  
1365: Preston & Arapaho

Lane Group	SBL	SBT	SBR
Total Split (%)	11.3%	43.8%	
Maximum Green (s)	12.5	64.3	
Yellow Time (s)	3.0	4.7	
All-Red Time (s)	2.5	1.0	
Lost Time Adjust (s)	-1.0	-1.7	
Total Lost Time (s)	4.5	4.0	
Lead/Lag	Lag	Lag	
Lead-Lag Optimize?	Yes	Yes	
Vehicle Extension (s)	1.5	1.5	
Recall Mode	None	C-Max	
Walk Time (s)		4.0	
Flash Dont Walk (s)		28.0	
Pedestrian Calls (#/hr)		0	
Act Effct Green (s)	13.5	71.4	
Actuated g/C Ratio	0.08	0.45	
v/c Ratio	0.79	0.72	
Control Delay	78.3	32.9	
Queue Delay	0.0	0.0	
Total Delay	78.3	32.9	
LOS	E	C	
Approach Delay		38.5	
Approach LOS		D	
90th %ile Green (s)	12.5	65.8	
90th %ile Term Code	Max	Coord	
70th %ile Green (s)	12.5	68.1	
70th %ile Term Code	Max	Coord	
50th %ile Green (s)	12.5	69.7	
50th %ile Term Code	Max	Coord	
30th %ile Green (s)	12.5	71.4	
30th %ile Term Code	Max	Coord	
10th %ile Green (s)	12.5	73.7	
10th %ile Term Code	Hold	Coord	
Queue Length 50th (ft)	123	505	
Queue Length 95th (ft)	m148	552	
Internal Link Dist (ft)		5007	
Turn Bay Length (ft)	250		
Base Capacity (vph)	289	2239	
Starvation Cap Reductn	0	0	
Spillback Cap Reductn	0	0	
Storage Cap Reductn	0	0	
Reduced v/c Ratio	0.79	0.72	
<b>Intersection Summary</b>			

Pepper Square TIA  
Lanes, Volumes, Timings

2021 - Existing - PM  
1365: Preston & Arapaho

Maximum v/c Ratio: 0.92	Intersection LOS: D
Intersection Signal Delay: 43.4	ICU Level of Service E
Intersection Capacity Utilization 83.6%	
Analysis Period (min) 15	
# 95th percentile volume exceeds capacity, queue may be longer. Queue shown is maximum after two cycles.	
m Volume for 95th percentile queue is metered by upstream signal.	

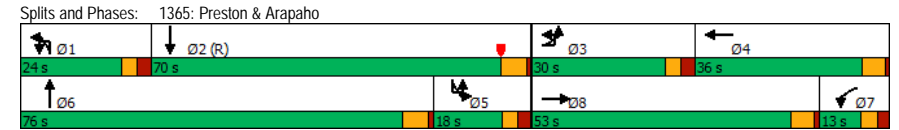



Pepper Square TIA  
Lanes, Volumes, Timings

2021 - Existing - PM  
1367: Preston & Belt Line



Lane Group	EBU	EBL	EBT	EBR	WBU	WBL	WBT	WBR	NBL	NBT	NBR	SBU
Lane Configurations		↔	↔↔	↔		↔	↔↔		↔	↔↔		
Traffic Volume (vph)	44	332	966	337	1	89	613	97	447	1775	60	2
Future Volume (vph)	44	332	966	337	1	89	613	97	447	1775	60	2
Ideal Flow (vphpl)	1900	1900	1900	1900	1900	1900	1900	1900	1900	1900	1900	1900
Storage Length (ft)		150		150		200		0	250		0	
Storage Lanes		2		1		1		0	2		0	
Taper Length (ft)		25				25			25			
Lane Util. Factor	0.91	0.97	0.91	1.00	0.91	1.00	0.91	0.91	0.97	0.91	0.91	0.91
Fr				0.850				0.980		0.995		
Flt Protected		0.950				0.950			0.950			
Satd. Flow (prot)	0	3433	5085	1583	0	1770	4984	0	3433	5060	0	0
Flt Permitted		0.950				0.950			0.950			
Satd. Flow (perm)	0	3433	5085	1583	0	1770	4984	0	3433	5060	0	0
Right Turn on Red				Yes			Yes			Yes		
Satd. Flow (RTOR)				211			16			4		
Link Speed (mph)			42				42			42		
Link Distance (ft)			925				394			261		
Travel Time (s)			15.0				6.4			4.2		
Peak Hour Factor	0.96	0.96	0.96	0.96	0.96	0.96	0.96	0.96	0.96	0.96	0.96	0.96
Adj. Flow (vph)	46	346	1006	351	1	93	639	101	466	1849	63	2
Shared Lane Traffic (%)												
Lane Group Flow (vph)	0	392	1006	351	0	94	740	0	466	1912	0	0
Enter Blocked Intersection	No	No	No	No	No	No	No	No	No	No	No	No
Lane Alignment	R NA	Left	Left	Right	R NA	Left	Left	Right	Left	Left	Right	R NA
Median Width(ft)			24				24			24		
Link Offset(ft)			0				0			0		
Crosswalk Width(ft)			16				16			16		
Two way Left Turn Lane												
Headway Factor	1.00	1.00	1.00	1.00	1.00	1.00	1.00	1.00	1.00	1.00	1.00	1.00
Turning Speed (mph)	9	15		9	9	15		9	15		9	9
Number of Detectors	1	1	1	1	1	1	1	1	1	1	1	1
Detector Template												
Leading Detector (ft)	50	50	50	50	50	50	50		50	50		50
Trailing Detector (ft)	0	0	0	0	0	0	0		0	0		0
Detector 1 Position(ft)	0	0	0	0	0	0	0		0	0		0
Detector 1 Size(ft)	50	50	50	50	50	50	50		50	50		50
Detector 1 Type	Cl+Ex	Cl+Ex	Cl+Ex	Cl+Ex	Cl+Ex	Cl+Ex	Cl+Ex		Cl+Ex	Cl+Ex		Cl+Ex
Detector 1 Channel												
Detector 1 Extend (s)	0.0	0.0	0.0	0.0	0.0	0.0	0.0		0.0	0.0		0.0
Detector 1 Queue (s)	0.0	0.0	0.0	0.0	0.0	0.0	0.0		0.0	0.0		0.0
Detector 1 Delay (s)	0.0	0.0	0.0	0.0	0.0	0.0	0.0		0.0	0.0		0.0
Turn Type	Prot	Prot	NA	Perm	Prot	Prot	NA		Prot	NA		Prot
Protected Phases	3 13	3 13	8		17	17	4		1 11	6		5
Permitted Phases				8								
Detector Phase	3 13	3 13	8		17	17	4		1 11	6		5
Switch Phase												
Minimum Initial (s)			18.0	18.0	3.0	3.0	18.0			18.0		3.0
Minimum Split (s)			32.5	32.5	8.0	8.0	32.5			33.0		11.0
Total Split (s)			50.0	50.0	14.0	14.0	27.0			77.0		19.0

Pepper Square TIA  
Lanes, Volumes, Timings

2021 - Existing - PM  
1367: Preston & Belt Line



Lane Group	SBL	SBT	SBR	Ø1	Ø3	Ø11	Ø13
Lane Configurations	↔	↔↔	↔				
Traffic Volume (vph)	129	1317	243				
Future Volume (vph)	129	1317	243				
Ideal Flow (vphpl)	1900	1900	1900				
Storage Length (ft)	200		300				
Storage Lanes	1		1				
Taper Length (ft)	25						
Lane Util. Factor	1.00	0.91	1.00				
Fr			0.850				
Flt Protected	0.950						
Satd. Flow (prot)	1770	5085	1583				
Flt Permitted	0.950						
Satd. Flow (perm)	1770	5085	1583				
Right Turn on Red			Yes				
Satd. Flow (RTOR)			226				
Link Speed (mph)		40					
Link Distance (ft)		3054					
Travel Time (s)		52.1					
Peak Hour Factor	0.96	0.96	0.96				
Adj. Flow (vph)	134	1372	253				
Shared Lane Traffic (%)							
Lane Group Flow (vph)	136	1372	253				
Enter Blocked Intersection	No	No	No				
Lane Alignment	Left	Left	Right				
Median Width(ft)		24					
Link Offset(ft)		0					
Crosswalk Width(ft)		16					
Two way Left Turn Lane							
Headway Factor	1.00	1.00	1.00				
Turning Speed (mph)	15		9				
Number of Detectors	1	1	1				
Detector Template							
Leading Detector (ft)	50	50	50				
Trailing Detector (ft)	0	0	0				
Detector 1 Position(ft)	0	0	0				
Detector 1 Size(ft)	50	50	50				
Detector 1 Type	Cl+Ex	Cl+Ex	Cl+Ex				
Detector 1 Channel							
Detector 1 Extend (s)	0.0	0.0	0.0				
Detector 1 Queue (s)	0.0	0.0	0.0				
Detector 1 Delay (s)	0.0	0.0	0.0				
Turn Type	Prot	NA	Perm				
Protected Phases	5	2		1	3	11	13
Permitted Phases			2				
Detector Phase	5	2	2				
Switch Phase							
Minimum Initial (s)	3.0	18.0	18.0	3.0	3.0	3.0	3.0
Minimum Split (s)	11.0	33.0	33.0	8.0	11.0	8.0	11.0
Total Split (s)	19.0	60.0	60.0	16.0	20.0	20.0	17.0

Pepper Square TIA  
Lanes, Volumes, Timings

2021 - Existing - PM  
1367: Preston & Belt Line



Lane Group	EBU	EBL	EBT	EBR	WBU	WBL	WBT	WBR	NBL	NBT	NBR	SBU
Total Split (%)			31.3%	31.3%	8.8%	8.8%	16.9%			48.1%		11.9%
Maximum Green (s)			44.5	44.5	9.0	9.0	21.5			71.0		14.0
Yellow Time (s)			4.0	4.0	3.0	3.0	4.0			4.4		3.0
All-Red Time (s)			1.5	1.5	2.0	2.0	1.5			1.6		2.0
Lost Time Adjust (s)			-1.5	-1.5		-1.0	-1.5			-1.7		
Total Lost Time (s)			4.0	4.0		4.0	4.0			4.3		
Lead/Lag							Lag			Lag		Lead
Lead-Lag Optimize?							Yes			Yes		Yes
Vehicle Extension (s)			1.3	1.3	3.0	3.0	1.3			2.0		1.5
Recall Mode			Min	Min	None	None	Min			C-Max		None
Walk Time (s)			7.0	7.0			7.0			7.0		
Flash Dont Walk (s)			20.0	20.0			20.0			20.0		
Pedestrian Calls (#/hr)			0	0			0			0		
Act Effct Green (s)	26.8	37.7	37.7		16.5	23.5		32.8	74.5			
Actuated g/C Ratio	0.17	0.24	0.24		0.10	0.15		0.20	0.47			
v/c Ratio	0.68	0.84	0.66		0.51	0.99		0.66	0.81			
Control Delay	57.9	69.6	34.7		79.1	97.2		40.9	19.7			
Queue Delay	0.0	0.0	0.0		0.0	0.0		0.0	0.5			
Total Delay	57.9	69.6	34.7		79.1	97.2		40.9	20.2			
LOS	E	E	C		E	F		D	C			
Approach Delay			60.0			95.1			24.3			
Approach LOS			E			F			C			
90th %ile Green (s)			42.2	42.2	11.3	11.3	21.5		71.0			14.0
90th %ile Term Code			Gap	Gap	Max	Max	Max		Coord			Max
70th %ile Green (s)			38.8	38.8	14.7	14.7	21.5		71.0			14.0
70th %ile Term Code			Gap	Gap	Max	Max	Max		Coord			Max
50th %ile Green (s)			36.5	36.5	15.2	15.2	21.5		71.0			15.8
50th %ile Term Code			Gap	Gap	Gap	Gap	Max		Coord			Max
30th %ile Green (s)			34.0	34.0	16.4	16.4	21.5		73.3			14.8
30th %ile Term Code			Gap	Gap	Hold	Hold	Max		Coord			Gap
10th %ile Green (s)			29.7	29.7	20.1	20.1	23.8		77.7			11.0
10th %ile Term Code			Gap	Gap	Hold	Hold	Max		Coord			Gap
Queue Length 50th (ft)	167	389	162		95	-292		186	602			
Queue Length 95th (ft)	234	430	291		#184	#386		257	584			
Internal Link Dist (ft)			845			314			181			
Turn Bay Length (ft)	150		150		200			250				
Base Capacity (vph)	622	1461	605		183	744		702	2358			
Starvation Cap Reductn	0	0	0		0	0		0	140			
Spillback Cap Reductn	0	0	0		0	0		0	0			
Storage Cap Reductn	0	0	0		0	0		0	0			
Reduced v/c Ratio	0.63	0.69	0.58		0.51	0.99		0.66	0.86			

Intersection Summary

Area Type: Other  
 Cycle Length: 160  
 Actuated Cycle Length: 160  
 Offset: 56 (35%), Referenced to phase 6:NBT, Start of Yellow  
 Natural Cycle: 115  
 Control Type: Actuated-Coordinated

Pepper Square TIA  
Lanes, Volumes, Timings

2021 - Existing - PM  
1367: Preston & Belt Line



Lane Group	SBL	SBT	SBR	Ø1	Ø3	Ø11	Ø13
Total Split (%)	11.9%	37.5%	37.5%	10%	13%	13%	11%
Maximum Green (s)	14.0	54.0	54.0	11.0	15.0	15.0	12.0
Yellow Time (s)	3.0	4.4	4.4	3.0	3.0	3.0	3.0
All-Red Time (s)	2.0	1.6	1.6	2.0	2.0	2.0	2.0
Lost Time Adjust (s)	-1.0	-1.7	-1.7				
Total Lost Time (s)	4.0	4.3	4.3				
Lead/Lag	Lead	Lag	Lag	Lead	Lead		
Lead-Lag Optimize?	Yes	Yes	Yes	Yes	Yes		
Vehicle Extension (s)	1.5	2.5	2.5	1.6	1.3	3.0	3.0
Recall Mode	None	Ped	Ped	None	None	None	None
Walk Time (s)		7.0	7.0				
Flash Dont Walk (s)		20.0	20.0				
Pedestrian Calls (#/hr)		0	0				
Act Effct Green (s)	14.9	52.7	52.7				
Actuated g/C Ratio	0.09	0.33	0.33				
v/c Ratio	0.83	0.82	0.38				
Control Delay	80.3	43.8	11.3				
Queue Delay	0.0	0.0	0.0				
Total Delay	80.3	43.8	11.3				
LOS	F	D	B				
Approach Delay		41.9					
Approach LOS		D					
90th %ile Green (s)	14.0	54.0	54.0	11.0	15.0	15.0	12.0
90th %ile Term Code	Max	Coord	Coord	Max	Max	Max	Max
70th %ile Green (s)	14.0	53.9	53.9	11.0	15.0	15.1	12.0
70th %ile Term Code	Max	Coord	Coord	Max	Max	Max	Hold
50th %ile Green (s)	15.8	51.5	51.5	12.8	15.0	17.5	10.2
50th %ile Term Code	Max	Coord	Coord	Max	Max	Hold	Hold
30th %ile Green (s)	14.8	49.1	49.1	12.9	15.0	21.1	8.9
30th %ile Term Code	Gap	Coord	Coord	Gap	Max	Hold	Gap
10th %ile Green (s)	11.0	46.3	46.3	11.0	12.7	26.4	8.3
10th %ile Term Code	Gap	Coord	Coord	Gap	Gap	Hold	Gap
Queue Length 50th (ft)	120	530	127				
Queue Length 95th (ft)	m#212	585	m169				
Internal Link Dist (ft)		2974					
Turn Bay Length (ft)	200		300				
Base Capacity (vph)	171	1770	698				
Starvation Cap Reductn	0	0	0				
Spillback Cap Reductn	0	0	0				
Storage Cap Reductn	0	0	0				
Reduced v/c Ratio	0.80	0.78	0.36				

Intersection Summary

Pepper Square TIA  
Lanes, Volumes, Timings

2021 - Existing - PM  
1367: Preston & Belt Line

Maximum v/c Ratio: 0.99	Intersection LOS: D
Intersection Signal Delay: 47.0	ICU Level of Service E
Intersection Capacity Utilization 82.2%	
Analysis Period (min) 15	
- Volume exceeds capacity, queue is theoretically infinite. Queue shown is maximum after two cycles.	
# 95th percentile volume exceeds capacity, queue may be longer. Queue shown is maximum after two cycles.	
m Volume for 95th percentile queue is metered by upstream signal.	

Splits and Phases: 1367: Preston & Belt Line

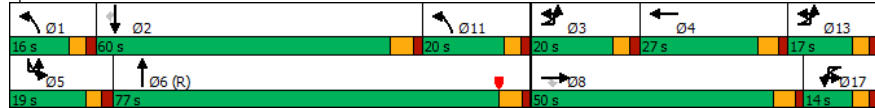

Pepper Square TIA  
Lanes, Volumes, Timings

2021 - Existing - PM  
1368: Preston & Alexis

	EBL	EBT	EBR	WBL	WBT	WBR	NBU	NBL	NBT	NBR	SBL	SBT
Lane Group	EBL	EBT	EBR	WBL	WBT	WBR	NBU	NBL	NBT	NBR	SBL	SBT
Lane Configurations	↙	↕	↘	↙	↕	↘	↙	↕	↘	↙	↕	↘
Traffic Volume (vph)	64	23	62	208	23	65	7	42	2185	230	113	1549
Future Volume (vph)	64	23	62	208	23	65	7	42	2185	230	113	1549
Ideal Flow (vphpl)	1900	1900	1900	1900	1900	1900	1900	1900	1900	1900	1900	1900
Storage Length (ft)	0		0	175		0		150		150	150	
Storage Lanes	1		1	2		1		1		1	1	
Taper Length (ft)	25			25				25			25	
Lane Util. Factor	0.91	0.91	1.00	0.97	1.00	1.00	0.91	1.00	0.91	1.00	1.00	0.91
Frt			0.850			0.850				0.850		
Flt Protected	0.950	0.972		0.950				0.950			0.950	
Satd. Flow (prot)	1610	3295	1583	3433	1863	1583	0	1770	5085	1583	1770	5085
Flt Permitted	0.950	0.972		0.950				0.119			0.039	
Satd. Flow (perm)	1610	3295	1583	3433	1863	1583	0	222	5085	1583	73	5085
Right Turn on Red			Yes			Yes				Yes		
Satd. Flow (RTOR)			125			85				102		
Link Speed (mph)		30			30				43			42
Link Distance (ft)		660			627				2867			173
Travel Time (s)		15.0			14.3				45.5			2.8
Peak Hour Factor	0.95	0.95	0.95	0.95	0.95	0.95	0.95	0.95	0.95	0.95	0.95	0.95
Adj. Flow (vph)	67	24	65	219	24	68	7	44	2300	242	119	1631
Shared Lane Traffic (%)	50%											
Lane Group Flow (vph)	33	58	65	219	24	68	0	51	2300	242	119	1631
Enter Blocked Intersection	No	No	No	No	No	No	No	No	No	No	No	No
Lane Alignment	Left	Left	Right	Left	Left	Right	R NA	Left	Left	Right	Left	Left
Median Width(ft)		24			24				12			12
Link Offset(ft)		0			0				0			0
Crosswalk Width(ft)		16			16				16			16
Two way Left Turn Lane												
Headway Factor	1.00	1.00	1.00	1.00	1.00	1.00	1.00	1.00	1.00	1.00	1.00	1.00
Turning Speed (mph)	15		9	15		9	9	15		9	15	
Number of Detectors	1	1	1	1	1	1	1	1	1	1	1	1
Detector Template												
Leading Detector (ft)	50	50	50	50	50	50	50	50	50	50	50	50
Trailing Detector (ft)	0	0	0	0	0	0	0	0	0	0	0	0
Detector 1 Position(ft)	0	0	0	0	0	0	0	0	0	0	0	0
Detector 1 Size(ft)	50	50	50	50	50	50	50	50	50	50	50	50
Detector 1 Type	Cl+Ex	Cl+Ex	Cl+Ex	Cl+Ex	Cl+Ex	Cl+Ex	Cl+Ex	Cl+Ex	Cl+Ex	Cl+Ex	Cl+Ex	Cl+Ex
Detector 1 Channel												
Detector 1 Extend (s)	0.0	0.0	0.0	0.0	0.0	0.0	0.0	0.0	0.0	0.0	0.0	0.0
Detector 1 Queue (s)	0.0	0.0	0.0	0.0	0.0	0.0	0.0	0.0	0.0	0.0	0.0	0.0
Detector 1 Delay (s)	0.0	0.0	0.0	0.0	0.0	0.0	0.0	0.0	0.0	0.0	0.0	0.0
Turn Type	Split	NA	Perm	Split	NA	pm+ov	D.P+P	D.P+P	NA	Perm	D.P+P	NA
Protected Phases	3	3		4	4	5	1	1	6		5	2
Permitted Phases			3			4	2	2		6	6	
Detector Phases	3	3	3	4	4	5	1	1	6	6	5	2
Switch Phase												
Minimum Initial (s)	6.0	6.0	6.0	8.0	8.0	3.0	3.0	3.0	14.0	14.0	3.0	14.0
Minimum Split (s)	27.0	27.0	27.0	27.0	27.0	8.4	8.4	8.4	24.0	24.0	8.4	24.0
Total Split (s)	23.0	23.0	23.0	22.0	22.0	20.0	15.0	15.0	95.0	95.0	20.0	100.0

Pepper Square TIA  
Lanes, Volumes, Timings

2021 - Existing - PM  
1368: Preston & Alexis

Lane Group	SBR
Left-Through Configurations	7
Traffic Volume (vph)	22
Future Volume (vph)	22
Ideal Flow (vphpl)	1900
Storage Length (ft)	150
Storage Lanes	1
Taper Length (ft)	
Lane Util. Factor	1.00
Frt	0.850
Flt Protected	
Satd. Flow (prot)	1583
Flt Permitted	
Satd. Flow (perm)	1583
Right Turn on Red	Yes
Satd. Flow (RTOR)	78
Link Speed (mph)	
Link Distance (ft)	
Travel Time (s)	
Peak Hour Factor	0.95
Adj. Flow (vph)	23
Shared Lane Traffic (%)	
Lane Group Flow (vph)	23
Enter Blocked Intersection	No
Lane Alignment	Right
Median Width(ft)	
Link Offset(ft)	
Crosswalk Width(ft)	
Two way Left Turn Lane	
Headway Factor	1.00
Turning Speed (mph)	9
Number of Detectors	1
Detector Template	
Leading Detector (ft)	50
Trailing Detector (ft)	0
Detector 1 Position(ft)	0
Detector 1 Size(ft)	50
Detector 1 Type	Cl+Ex
Detector 1 Channel	
Detector 1 Extnd (s)	0.0
Detector 1 Queue (s)	0.0
Detector 1 Delay (s)	0.0
Turn Type	Perm
Protected Phases	
Permitted Phases	2
Detector Phase	2
Switch Phase	
Minimum Initial (s)	14.0
Minimum Split (s)	24.0
Total Split (s)	100.0

Pepper Square TIA  
Lanes, Volumes, Timings

2021 - Existing - PM  
1368: Preston & Alexis

Lane Group	EBL	EBT	EBR	WBL	WBT	WBR	NBU	NBL	NBT	NBR	SBL	SBT
Total Split (%)	14.4%	14.4%	14.4%	13.8%	13.8%	12.5%	9.4%	9.4%	59.4%	59.4%	12.5%	62.5%
Maximum Green (s)	18.0	18.0	18.0	17.0	17.0	15.6	10.6	10.6	89.0	89.0	15.6	94.0
Yellow Time (s)	4.0	4.0	4.0	4.0	4.0	3.4	3.4	3.4	4.5	4.5	3.4	4.5
All-Red Time (s)	1.0	1.0	1.0	1.0	1.0	1.0	1.0	1.0	1.5	1.5	1.0	1.5
Lost Time Adjust (s)	-1.0	-1.0	0.0	-1.0	-1.0	0.0			-1.0	-2.0	0.0	-1.0
Total Lost Time (s)	4.0	4.0	5.0	4.0	4.0	4.4			3.4	4.0	6.0	3.4
Lead/Lag	Lag	Lag	Lag	Lead	Lead	Lag	Lead	Lead	Lead	Lead	Lag	Lag
Lead-Lag Optimize?	Yes	Yes	Yes	Yes	Yes	Yes	Yes	Yes	Yes	Yes	Yes	Yes
Vehicle Extension (s)	2.0	2.0	2.0	2.0	2.0	1.2	1.2	1.2	2.5	2.5	1.2	2.5
Recall Mode	None	None	None	None	None	None	None	None	Max	Max	None	C-Max
Walk Time (s)	4.0	4.0	4.0	4.0	4.0				4.0	4.0		4.0
Flash Dont Walk (s)	18.0	18.0	18.0	18.0	18.0				14.0	14.0		14.0
Pedestrian Calls (#/hr)	0	0	0	0	0				0	0		0
Act Effct Green (s)	9.0	9.0	8.0	15.2	15.2	34.8			121.7	103.8	101.8	121.0
Actuated g/C Ratio	0.06	0.06	0.05	0.10	0.10	0.22			0.76	0.65	0.64	0.76
v/c Ratio	0.37	0.31	0.33	0.67	0.14	0.17			0.23	0.70	0.23	0.52
Control Delay	83.3	76.2	4.4	80.4	67.0	6.1			6.7	15.9	5.8	28.9
Queue Delay	0.0	0.0	0.0	0.0	0.0	0.0			0.0	0.0	0.0	0.0
Total Delay	83.3	76.2	4.4	80.4	67.0	6.1			6.7	15.9	5.8	28.9
LOS	F	E	A	F	E	A			A	B	A	C
Approach Delay		47.8			63.1				14.8			4.7
Approach LOS		D			E				B			A
90th %ile Green (s)	11.1	11.1	11.1	17.0	17.0	15.6	6.0	6.0	95.9	95.9	15.6	105.5
90th %ile Term Code	Gap	Gap	Gap	Max	Max	Max	Gap	Gap	Coord	Coord	Max	Coord
70th %ile Green (s)	9.1	9.1	9.1	16.2	16.2	15.6	5.2	5.2	98.7	98.7	15.6	109.1
70th %ile Term Code	Gap	Gap	Gap	Gap	Gap	Hold	Gap	Gap	Coord	Coord	Hold	Coord
50th %ile Green (s)	7.7	7.7	7.7	14.5	14.5	15.6	4.7	4.7	101.8	101.8	15.6	112.7
50th %ile Term Code	Gap	Gap	Gap	Gap	Gap	Hold	Gap	Gap	Coord	Coord	Hold	Coord
30th %ile Green (s)	6.3	6.3	6.3	12.8	12.8	15.6	4.3	4.3	104.9	104.9	15.6	116.2
30th %ile Term Code	Gap	Gap	Gap	Gap	Gap	Hold	Gap	Gap	Coord	Coord	Hold	Coord
10th %ile Green (s)	6.0	6.0	6.0	10.4	10.4	15.6	0.0	0.0	107.6	107.6	15.6	127.6
10th %ile Term Code	Min	Min	Min	Gap	Gap	Hold	Skip	Skip	Coord	Coord	Hold	Coord
Queue Length 50th (ft)	37	32	0	115	23	0			9	414	36	71
Queue Length 95th (ft)	79	58	0	160	55	28			20	599	64	140
Internal Link Dist (ft)		580			547				2787			93
Turn Bay Length (ft)				175					150		150	
Base Capacity (vph)	191	391	289	386	209	410			284	3298	1043	231
Starvation Cap Reductn	0	0	0	0	0	0			0	0	0	0
Spillback Cap Reductn	0	0	0	0	0	0			0	0	0	0
Storage Cap Reductn	0	0	0	0	0	0			0	0	0	0
Reduced v/c Ratio	0.17	0.15	0.22	0.57	0.11	0.17			0.18	0.70	0.23	0.52

<b>Intersection Summary</b>	
Area Type:	Other
Cycle Length:	160
Actuated Cycle Length:	160
Offset:	63 (39%), Referenced to phase 2:NBSB, Start of Yellow
Natural Cycle:	120
Control Type:	Actuated-Coordinated

Pepper Square TIA  
Lanes, Volumes, Timings

2021 - Existing - PM  
1368: Preston & Alexis

Lane Group	SBR
Total Split (%)	62.5%
Maximum Green (s)	94.0
Yellow Time (s)	4.5
All-Red Time (s)	1.5
Lost Time Adjust (s)	0.0
Total Lost Time (s)	6.0
Lead/Lag	Lag
Lead-Lag Optimize?	Yes
Vehicle Extension (s)	2.5
Recall Mode	C-Max
Walk Time (s)	4.0
Flash Dont Walk (s)	14.0
Pedestrian Calls (#/hr)	0
Act Effct Green (s)	114.2
Actuated g/C Ratio	0.71
v/c Ratio	0.02
Control Delay	0.0
Queue Delay	0.0
Total Delay	0.0
LOS	A
<b>Approach Delay</b>	
Approach LOS	
90th %ile Green (s)	105.5
90th %ile Term Code	Coord
70th %ile Green (s)	109.1
70th %ile Term Code	Coord
50th %ile Green (s)	112.7
50th %ile Term Code	Coord
30th %ile Green (s)	116.2
30th %ile Term Code	Coord
10th %ile Green (s)	127.6
10th %ile Term Code	Coord
Queue Length 50th (ft)	0
Queue Length 95th (ft)	m0
<b>Internal Link Dist (ft)</b>	
Turn Bay Length (ft)	150
Base Capacity (vph)	1152
Starvation Cap Reductn	0
Spillback Cap Reductn	0
Storage Cap Reductn	0
Reduced v/c Ratio	0.02
<b>Intersection Summary</b>	

Pepper Square TIA  
Lanes, Volumes, Timings

2021 - Existing - PM  
1368: Preston & Alexis

Maximum v/c Ratio: 0.70	
Intersection Signal Delay: 15.3	Intersection LOS: B
Intersection Capacity Utilization 71.1%	ICU Level of Service C
Analysis Period (min) 15	
m Volume for 95th percentile queue is metered by upstream signal.	

Splits and Phases: 1368: Preston & Alexis

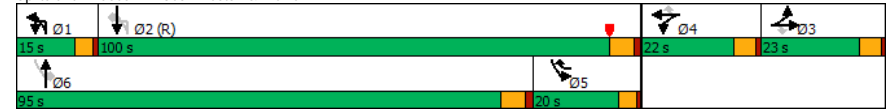

Pepper Square TIA  
Lanes, Volumes, Timings

2021 - Existing - PM  
1369: Preston & Belt Line Village Driveway



Lane Group	EBL	EBT	EBR	WBL	WBT	WBR	NBU	NBL	NBT	NBR	SBU	SBL
Lane Configurations		↔			↕			↔	↔			↔
Traffic Volume (vph)	77	5	52	24	6	18	1	65	2120	12	8	56
Future Volume (vph)	77	5	52	24	6	18	1	65	2120	12	8	56
Ideal Flow (vphpl)	1900	1900	1900	1900	1900	1900	1900	1900	1900	1900	1900	1900
Storage Length (ft)	0		0	0		0		100		0		100
Storage Lanes	0		0	0		0		1		0		1
Taper Length (ft)	25			25				25				25
Lane Util. Factor	0.95	0.95	0.95	1.00	1.00	1.00	0.91	1.00	0.91	0.91	0.91	1.00
Fr		0.941			0.949				0.999			
Flt Protected		0.972			0.976			0.950				0.950
Satd. Flow (prot)	0	3237	0	0	1725	0	0	1770	5080	0	0	1770
Flt Permitted		0.764			0.815			0.095				0.056
Satd. Flow (perm)	0	2544	0	0	1441	0	0	177	5080	0	0	104
Right Turn on Red			Yes			Yes				Yes		
Satd. Flow (RTOR)		54			19				1			
Link Speed (mph)		30			30				42			
Link Distance (ft)		303			249				252			
Travel Time (s)		6.9			5.7				4.1			
Peak Hour Factor	0.97	0.97	0.97	0.97	0.97	0.97	0.97	0.97	0.97	0.97	0.97	0.97
Adj. Flow (vph)	79	5	54	25	6	19	1	67	2186	12	8	58
Shared Lane Traffic (%)												
Lane Group Flow (vph)	0	138	0	0	50	0	0	68	2198	0	0	66
Enter Blocked Intersection	No	No	No	No	No	No	No	No	No	No	No	No
Lane Alignment	Left	Left	Right	Left	Left	Right	R NA	Left	Left	Right	R NA	Left
Median Width(ft)		0			0				12			
Link Offset(ft)		0			0				0			
Crosswalk Width(ft)		16			16				16			
Two way Left Turn Lane												
Headway Factor	1.00	1.00	1.00	1.00	1.00	1.00	1.00	1.00	1.00	1.00	1.00	1.00
Turning Speed (mph)	15		9	15		9	9	15		9	9	15
Number of Detectors	1	1		1	1		1	1	1		1	1
Detector Template												
Leading Detector (ft)	50	50		50	50		50	50	50		50	50
Trailing Detector (ft)	0	0		0	0		0	0	0		0	0
Detector 1 Position(ft)	0	0		0	0		0	0	0		0	0
Detector 1 Size(ft)	50	50		50	50		50	50	50		50	50
Detector 1 Type	Cl+Ex	Cl+Ex		Cl+Ex	Cl+Ex		Cl+Ex	Cl+Ex	Cl+Ex		Cl+Ex	Cl+Ex
Detector 1 Channel												
Detector 1 Extend (s)	0.0	0.0		0.0	0.0		0.0	0.0	0.0		0.0	0.0
Detector 1 Queue (s)	0.0	0.0		0.0	0.0		0.0	0.0	0.0		0.0	0.0
Detector 1 Delay (s)	0.0	0.0		0.0	0.0		0.0	0.0	0.0		0.0	0.0
Turn Type	Perm	NA		Perm	NA		custom	D.P+P	NA		custom	D.P+P
Protected Phases		8			4			1	6			5
Permitted Phases		8			4			1	2			5
Detector Phase		8			4			1	1			5
Switch Phase												
Minimum Initial (s)	20.0	20.0		20.0	20.0		5.0	5.0	20.0		5.0	5.0
Minimum Split (s)	25.0	25.0		25.0	25.0		10.0	10.0	26.0		10.0	10.0
Total Split (s)	47.0	47.0		47.0	47.0		20.0	20.0	98.0		15.0	15.0

Pepper Square TIA  
Lanes, Volumes, Timings

2021 - Existing - PM  
1369: Preston & Belt Line Village Driveway



Lane Group	SBT	SBR
Lane Configurations	↔	↔
Traffic Volume (vph)	1753	25
Future Volume (vph)	1753	25
Ideal Flow (vphpl)	1900	1900
Storage Length (ft)		0
Storage Lanes		0
Taper Length (ft)		
Lane Util. Factor	0.91	0.91
Fr	0.998	
Flt Protected		
Satd. Flow (prot)	5075	0
Flt Permitted		
Satd. Flow (perm)	5075	0
Right Turn on Red		Yes
Satd. Flow (RTOR)	2	
Link Speed (mph)	38	
Link Distance (ft)	191	
Travel Time (s)	3.4	
Peak Hour Factor	0.97	0.97
Adj. Flow (vph)	1807	26
Shared Lane Traffic (%)		
Lane Group Flow (vph)	1833	0
Enter Blocked Intersection	No	No
Lane Alignment	Left	Right
Median Width(ft)	12	
Link Offset(ft)	0	
Crosswalk Width(ft)	16	
Two way Left Turn Lane		
Headway Factor	1.00	1.00
Turning Speed (mph)		9
Number of Detectors	1	
Detector Template		
Leading Detector (ft)	50	
Trailing Detector (ft)	0	
Detector 1 Position(ft)	0	
Detector 1 Size(ft)	50	
Detector 1 Type	Cl+Ex	
Detector 1 Channel		
Detector 1 Extend (s)	0.0	
Detector 1 Queue (s)	0.0	
Detector 1 Delay (s)	0.0	
Turn Type	NA	
Protected Phases	2	
Permitted Phases		
Detector Phase	2	
Switch Phase		
Minimum Initial (s)	20.0	
Minimum Split (s)	26.0	
Total Split (s)	93.0	

Pepper Square TIA  
Lanes, Volumes, Timings

2021 - Existing - PM  
1369: Preston & Belt Line Village Driveway



Lane Group	EBL	EBT	EBR	WBL	WBT	WBR	NBU	NBL	NBT	NBR	SBU	SBL
Total Split (%)	29.4%	29.4%		29.4%	29.4%		12.5%	12.5%	61.3%		9.4%	9.4%
Maximum Green (s)	42.3	42.3		42.3	42.3		15.0	15.0	93.7		10.0	10.0
Yellow Time (s)	3.0	3.0		3.0	3.0		3.0	3.0	3.0		3.0	3.0
All-Red Time (s)	1.7	1.7		1.7	1.7		2.0	2.0	1.3		2.0	2.0
Lost Time Adjust (s)		-1.0			-1.0			-1.0	-2.0			-1.0
Total Lost Time (s)		3.7			3.7			4.0	2.3			4.0
Lead/Lag							Lead	Lead	Lead		Lag	Lag
Lead-Lag Optimize?							Yes	Yes	Yes		Yes	Yes
Vehicle Extension (s)	2.0	2.0		2.0	2.0		1.5	1.5	3.0		1.5	1.5
Recall Mode	None	None		None	None		None	None	Max		None	None
Walk Time (s)	5.0	5.0		5.0	5.0				7.0			
Flash Dont Walk (s)	15.0	15.0		15.0	15.0				8.0			
Pedestrian Calls (#/hr)	0	0		0	0				0			
Act Effct Green (s)		21.0			21.0		127.3	118.0				127.3
Actuated g/C Ratio		0.13			0.13		0.80	0.74				0.80
v/c Ratio		0.36			0.24		0.33	0.59				0.34
Control Delay		41.2			44.7		8.1	2.2				22.4
Queue Delay		0.0			0.0		0.0	0.2				0.0
Total Delay		41.2			44.7		8.1	2.4				22.4
LOS		D			D		A	A				C
Approach Delay		41.2			44.7			2.6				
Approach LOS		D			D			A				
90th %ile Green (s)	20.0	20.0		20.0	20.0		8.6	8.6	116.0		10.0	10.0
90th %ile Term Code	Min	Min		Min	Min		Gap	Gap	Coord		Max	Max
70th %ile Green (s)	20.0	20.0		20.0	20.0		6.0	6.0	116.0		10.0	10.0
70th %ile Term Code	Min	Min		Min	Min		Gap	Gap	Coord		Hold	Hold
50th %ile Green (s)	20.0	20.0		20.0	20.0		5.1	5.1	116.0		10.0	10.0
50th %ile Term Code	Min	Min		Min	Min		Gap	Gap	Coord		Hold	Hold
30th %ile Green (s)	20.0	20.0		20.0	20.0		5.0	5.0	116.0		10.0	10.0
30th %ile Term Code	Min	Min		Min	Min		Min	Min	Coord		Hold	Hold
10th %ile Green (s)	20.0	20.0		20.0	20.0		5.0	5.0	116.0		10.0	10.0
10th %ile Term Code	Min	Min		Hold	Hold		Min	Min	Coord		Hold	Hold
Queue Length 50th (ft)		42			29			3	40			21
Queue Length 95th (ft)		80			74			m8	41			m40
Internal Link Dist (ft)		223			169				172			
Turn Bay Length (ft)								100				100
Base Capacity (vph)		727			403			304	3746			197
Starvation Cap Reductn		0			0			0	561			0
Spillback Cap Reductn		1			0			0	312			0
Storage Cap Reductn		0			0			0	0			0
Reduced v/c Ratio		0.19			0.12			0.22	0.69			0.34

**Intersection Summary**  
 Area Type: Other  
 Cycle Length: 160  
 Actuated Cycle Length: 160  
 Offset: 86 (54%), Referenced to phase 2:NBSB, Start of Yellow  
 Natural Cycle: 65  
 Control Type: Actuated-Coordinated

Pepper Square TIA  
Lanes, Volumes, Timings

2021 - Existing - PM  
1369: Preston & Belt Line Village Driveway



Lane Group	SBT	SBR
Total Split (%)	58.1%	
Maximum Green (s)	88.7	
Yellow Time (s)	3.0	
All-Red Time (s)	1.3	
Lost Time Adjust (s)	-2.0	
Total Lost Time (s)	2.3	
Lead/Lag	Lag	
Lead-Lag Optimize?	Yes	
Vehicle Extension (s)	3.3	
Recall Mode	C-Max	
Walk Time (s)	7.0	
Flash Dont Walk (s)	8.0	
Pedestrian Calls (#/hr)	0	
Act Effct Green (s)	122.1	
Actuated g/C Ratio	0.76	
v/c Ratio	0.47	
Control Delay	2.7	
Queue Delay	0.2	
Total Delay	3.0	
LOS	A	
Approach Delay	3.6	
Approach LOS	A	
90th %ile Green (s)	117.4	
90th %ile Term Code	Coord	
70th %ile Green (s)	120.0	
70th %ile Term Code	Coord	
50th %ile Green (s)	120.9	
50th %ile Term Code	Coord	
30th %ile Green (s)	121.0	
30th %ile Term Code	Coord	
10th %ile Green (s)	121.0	
10th %ile Term Code	Coord	
Queue Length 50th (ft)	72	
Queue Length 95th (ft)	101	
Internal Link Dist (ft)	111	
Turn Bay Length (ft)		
Base Capacity (vph)	3871	
Starvation Cap Reductn	1082	
Spillback Cap Reductn	0	
Storage Cap Reductn	0	
Reduced v/c Ratio	0.66	

**Intersection Summary**

Pepper Square TIA  
Lanes, Volumes, Timings

2021 - Existing - PM  
1369: Preston & Belt Line Village Driveway

Maximum v/c Ratio: 0.59	Intersection LOS: A
Intersection Signal Delay: 4.7	ICU Level of Service C
Intersection Capacity Utilization 72.1%	
Analysis Period (min) 15	
m Volume for 95th percentile queue is metered by upstream signal.	

Splits and Phases: 1369: Preston & Belt Line Village Driveway

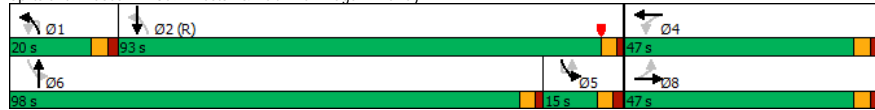

Pepper Square TIA  
Lanes, Volumes, Timings

2021 - Existing - PM  
1371: Preston & Spring Valley

Lane Group	EBL	EBT	EBR	WBL	WBT	WBR	NBU	NBL	NBT	NBR	SBU	SBL
Lane Configurations	↔↔	↑↑↑		↔↔	↑↑↑			↔↔	↑↑↑			↔↔
Traffic Volume (vph)	279	760	217	100	467	147	1	184	2082	191	6	147
Future Volume (vph)	279	760	217	100	467	147	1	184	2082	191	6	147
Ideal Flow (vphpl)	1900	1900	1900	1900	1900	1900	1900	1900	1900	1900	1900	1900
Storage Length (ft)	225		0	225		0		225		0		275
Storage Lanes	2		0	2		0		2		0		2
Taper Length (ft)	25			25				25				25
Lane Util. Factor	0.97	0.91	0.91	0.97	0.91	0.91	0.91	0.97	0.91	0.91	0.91	0.97
Frt		0.967			0.964				0.987			
Flt Protected	0.950			0.950				0.950				0.950
Satd. Flow (prot)	3433	4917	0	3433	4902	0	0	3433	5019	0	0	3433
Flt Permitted	0.950			0.950				0.950				0.950
Satd. Flow (perm)	3433	4917	0	3433	4902	0	0	3433	5019	0	0	3433
Right Turn on Red			Yes			Yes				Yes		
Satd. Flow (RTOR)		45			40				13			
Link Speed (mph)		38			42				41			
Link Distance (ft)		3259			5488				2139			
Travel Time (s)		58.5			89.1				35.6			
Peak Hour Factor	0.94	0.94	0.94	0.94	0.94	0.94	0.94	0.94	0.94	0.94	0.94	0.94
Adj. Flow (vph)	297	809	231	106	497	156	1	196	2215	203	6	156
Shared Lane Traffic (%)												
Lane Group Flow (vph)	297	1040	0	106	653	0	0	197	2418	0	0	162
Enter Blocked Intersection	No	No	No	No	No	No	No	No	No	No	No	No
Lane Alignment	Left	Left	Right	Left	Left	Right	R NA	Left	Left	Right	R NA	Left
Median Width(ft)		24			24				24			
Link Offset(ft)		0			0				0			
Crosswalk Width(ft)		16			16				16			
Two way Left Turn Lane												
Headway Factor	1.00	1.00	1.00	1.00	1.00	1.00	1.00	1.00	1.00	1.00	1.00	1.00
Turning Speed (mph)	15		9	15		9	9	15		9	9	15
Number of Detectors	1	1		1	1		1	1	1		1	1
Detector Template												
Leading Detector (ft)	50	50		50	50		50	50	50		50	50
Trailing Detector (ft)	0	0		0	0		0	0	0		0	0
Detector 1 Position(ft)	0	0		0	0		0	0	0		0	0
Detector 1 Size(ft)	50	50		50	50		50	50	50		50	50
Detector 1 Type	Cl+Ex	Cl+Ex		Cl+Ex	Cl+Ex		Cl+Ex	Cl+Ex	Cl+Ex		Cl+Ex	Cl+Ex
Detector 1 Channel												
Detector 1 Extnd (s)	0.0	0.0		0.0	0.0		0.0	0.0	0.0		0.0	0.0
Detector 1 Queue (s)	0.0	0.0		0.0	0.0		0.0	0.0	0.0		0.0	0.0
Detector 1 Delay (s)	0.0	0.0		0.0	0.0		0.0	0.0	0.0		0.0	0.0
Turn Type	Prot	NA		Prot	NA		Prot	Prot	NA		Prot	Prot
Protected Phases	3	8		7	4		1	1	6		5	5
Permitted Phases												
Detector Phase	3	8		7	4		1	1	6		5	5
Switch Phase												
Minimum Initial (s)	6.0	12.0		3.0	12.0		3.0	3.0	13.0		3.0	3.0
Minimum Split (s)	11.0	27.5		11.0	27.5		11.0	11.0	28.0		11.0	11.0
Total Split (s)	40.0	50.0		13.0	23.0		22.0	22.0	82.0		15.0	15.0



Pepper Square TIA  
Lanes, Volumes, Timings

2021 - Existing - PM  
1371: Preston & Spring Valley

Lane Group	SBT	SBR
Lane Configurations	↑↑↑	
Traffic Volume (vph)	1481	174
Future Volume (vph)	1481	174
Ideal Flow (vphpl)	1900	1900
Storage Length (ft)		0
Storage Lanes		0
Taper Length (ft)		
Lane Util. Factor	0.91	0.91
Frt	0.984	
Flt Protected		
Satd. Flow (prot)	5004	0
Flt Permitted		
Satd. Flow (perm)	5004	0
Right Turn on Red		Yes
Satd. Flow (RTOR)	16	
Link Speed (mph)	38	
Link Distance (ft)	1208	
Travel Time (s)	21.7	
Peak Hour Factor	0.94	0.94
Adj. Flow (vph)	1576	185
Shared Lane Traffic (%)		
Lane Group Flow (vph)	1761	0
Enter Blocked Intersection	No	No
Lane Alignment	Left	Right
Median Width(ft)	24	
Link Offset(ft)	0	
Crosswalk Width(ft)	16	
Two way Left Turn Lane		
Headway Factor	1.00	1.00
Turning Speed (mph)		9
Number of Detectors	1	
Detector Template		
Leading Detector (ft)	50	
Trailing Detector (ft)	0	
Detector 1 Position(ft)	0	
Detector 1 Size(ft)	50	
Detector 1 Type	Cl+Ex	
Detector 1 Channel		
Detector 1 Extend (s)	0.0	
Detector 1 Queue (s)	0.0	
Detector 1 Delay (s)	0.0	
Turn Type	NA	
Protected Phases	2	
Permitted Phases		
Detector Phase	2	
Switch Phase		
Minimum Initial (s)	18.0	
Minimum Split (s)	28.0	
Total Split (s)	75.0	

Pepper Square TIA  
Lanes, Volumes, Timings

2021 - Existing - PM  
1371: Preston & Spring Valley

Lane Group	EBL	EBT	EBR	WBL	WBT	WBR	NBU	NBL	NBT	NBR	SBU	SBL
Total Split (%)	25.0%	31.3%		8.1%	14.4%		13.8%	13.8%	51.3%		9.4%	9.4%
Maximum Green (s)	35.0	44.5		8.0	17.5		17.0	17.0	76.0		10.0	10.0
Yellow Time (s)	3.0	4.0		3.0	4.0		3.0	3.0	4.5		3.0	3.0
All-Red Time (s)	2.0	1.5		2.0	1.5		2.0	2.0	1.5		2.0	2.0
Lost Time Adjust (s)	-1.0	-1.5		-1.0	-1.5				-1.0	-2.0		-1.0
Total Lost Time (s)	4.0	4.0		4.0	4.0				4.0	4.0		4.0
Lead/Lag	Lead	Lead		Lag	Lag		Lead	Lead	Lead		Lag	Lag
Lead-Lag Optimize?	Yes	Yes		Yes	Yes		Yes	Yes	Yes		Yes	Yes
Vehicle Extension (s)	0.8	2.0		0.8	2.0		0.8	0.8	2.5		0.8	0.8
Recall Mode	None	Max		None	Max		None	None	None		None	None
Walk Time (s)		4.0			4.0				4.0			
Flash Dont Walk (s)		18.0			18.0				18.0			
Pedestrian Calls (#/hr)		0			0				0			
Act Effct Green (s)	18.2	46.0		9.0	36.8			13.4	78.0			11.0
Actuated g/C Ratio	0.11	0.29		0.06	0.23			0.08	0.49			0.07
v/c Ratio	0.76	0.72		0.55	0.56			0.69	0.99			0.69
Control Delay	76.9	50.5		70.6	47.6			82.6	57.7			71.1
Queue Delay	0.0	0.0		0.0	0.0			0.0	0.0			0.0
Total Delay	76.9	50.5		70.6	47.6			82.6	57.7			71.1
LOS	E	D		E	D			F	E			E
Approach Delay		56.3			50.8				59.6			
Approach LOS		E			D				E			
90th %ile Green (s)	22.1	44.5		8.0	30.4		16.3	16.3	76.0		10.0	10.0
90th %ile Term Code	Gap	MaxR		Max	MaxR		Gap	Gap	Coord		Max	Max
70th %ile Green (s)	19.2	44.5		8.0	33.3		14.0	14.0	76.0		10.0	10.0
70th %ile Term Code	Gap	MaxR		Max	MaxR		Gap	Gap	Coord		Max	Max
50th %ile Green (s)	17.2	44.5		8.0	35.3		12.4	12.4	76.0		10.0	10.0
50th %ile Term Code	Gap	MaxR		Max	MaxR		Gap	Gap	Coord		Max	Max
30th %ile Green (s)	15.2	44.5		8.0	37.3		10.8	10.8	76.0		10.0	10.0
30th %ile Term Code	Gap	MaxR		Hold	MaxR		Gap	Gap	Coord		Hold	Hold
10th %ile Green (s)	12.2	44.5		8.0	40.3		8.5	8.5	76.0		10.0	10.0
10th %ile Term Code	Gap	MaxR		Hold	MaxR		Gap	Gap	Coord		Hold	Hold
Queue Length 50th (ft)	156	360		58	217		108	745			87	
Queue Length 95th (ft)	205	406		m55	m221		m151	#1001			m115	
Internal Link Dist (ft)		3179			5408			2059				
Turn Bay Length (ft)	225			225			225				275	
Base Capacity (vph)	772	1445		193	1159		386	2453			236	
Starvation Cap Reductn	0	0		0	0		0	0			0	
Spillback Cap Reductn	0	0		0	0		0	0			0	
Storage Cap Reductn	0	0		0	0		0	0			0	
Reduced v/c Ratio	0.38	0.72		0.55	0.56			0.51	0.99			0.69

Intersection Summary	
Area Type:	Other
Cycle Length:	160
Actuated Cycle Length:	160
Offset:	135 (84%), Referenced to phase 2:SBT, Start of Yellow
Natural Cycle:	100
Control Type:	Actuated-Coordinated

Pepper Square TIA  
Lanes, Volumes, Timings

2021 - Existing - PM  
1371: Preston & Spring Valley

Lane Group	SBT	SBR
Total Split (%)	46.9%	
Maximum Green (s)	69.0	
Yellow Time (s)	4.5	
All-Red Time (s)	1.5	
Lost Time Adjust (s)	-2.0	
Total Lost Time (s)	4.0	
Lead/Lag	Lag	
Lead-Lag Optimize?	Yes	
Vehicle Extension (s)	2.4	
Recall Mode	C-Max	
Walk Time (s)	4.0	
Flash Dont Walk (s)	18.0	
Pedestrian Calls (#/hr)	0	
Act Effct Green (s)	75.6	
Actuated g/C Ratio	0.47	
v/c Ratio	0.74	
Control Delay	24.1	
Queue Delay	0.0	
Total Delay	24.1	
LOS	C	
Approach Delay	28.1	
Approach LOS	C	
90th %ile Green (s)	69.7	
90th %ile Term Code	Coord	
70th %ile Green (s)	72.0	
70th %ile Term Code	Coord	
50th %ile Green (s)	73.6	
50th %ile Term Code	Coord	
30th %ile Green (s)	75.2	
30th %ile Term Code	Coord	
10th %ile Green (s)	77.5	
10th %ile Term Code	Coord	
Queue Length 50th (ft)	226	
Queue Length 95th (ft)	478	
Internal Link Dist (ft)	1128	
Turn Bay Length (ft)		
Base Capacity (vph)	2372	
Starvation Cap Reductn	0	
Spillback Cap Reductn	0	
Storage Cap Reductn	0	
Reduced v/c Ratio	0.74	
<b>Intersection Summary</b>		

Pepper Square TIA  
Lanes, Volumes, Timings

2021 - Existing - PM  
1371: Preston & Spring Valley

Maximum v/c Ratio: 0.99	Intersection LOS: D
Intersection Signal Delay: 48.8	ICU Level of Service E
Intersection Capacity Utilization 85.0%	
Analysis Period (min) 15	
# 95th percentile volume exceeds capacity, queue may be longer. Queue shown is maximum after two cycles.	
m Volume for 95th percentile queue is metered by upstream signal.	

Splits and Phases: 1371: Preston & Spring Valley

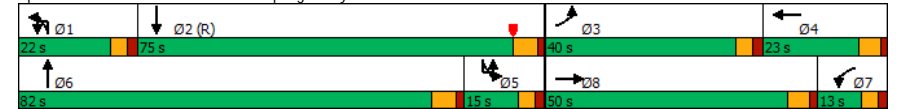

Pepper Square TIA  
Lanes, Volumes, Timings

2021 - Existing - PM  
1405: Prestonwood & Belt Line



Lane Group	EBU	EBL	EBT	EBR	WBU	WBL	WBT	WBR	NBL	NBT	NBR	SBL
Lane Configurations		↔	↔↔↔			↔	↔↔↔			↕		↔↔
Traffic Volume (vph)	7	77	1504	7	3	2	1223	102	6	1	2	146
Future Volume (vph)	7	77	1504	7	3	2	1223	102	6	1	2	146
Ideal Flow (vphpl)	1900	1900	1900	1900	1900	1900	1900	1900	1900	1900	1900	1900
Storage Length (ft)		200		0		200		0		0		0 300
Storage Lanes		1		0		1		0		0		0 2
Taper Length (ft)		25				25		25				25
Lane Util. Factor	0.91	1.00	0.91	0.91	0.91	1.00	0.91	0.91	1.00	1.00	1.00	0.97
Fr			0.999				0.988			0.970		
Flt Protected		0.950				0.950				0.968		0.950
Satd. Flow (prot)	0	1770	5080	0	0	1770	5024	0	0	1749	0	3433
Flt Permitted		0.086				0.133				0.968		0.950
Satd. Flow (perm)	0	160	5080	0	0	248	5024	0	0	1749	0	3433
Right Turn on Red				Yes				Yes			Yes	
Satd. Flow (RTOR)			1				13			2		
Link Speed (mph)		42				42				30		
Link Distance (ft)		1445				2036				315		
Travel Time (s)		23.5				33.1				7.2		
Peak Hour Factor	0.95	0.95	0.95	0.95	0.95	0.95	0.95	0.95	0.95	0.95	0.95	0.95
Adj. Flow (vph)	7	81	1583	7	3	2	1287	107	6	1	2	154
Shared Lane Traffic (%)												
Lane Group Flow (vph)	0	88	1590	0	0	5	1394	0	0	9	0	154
Enter Blocked Intersection	No	No	No	No	No	No	No	No	No	No	No	No
Lane Alignment	R NA	Left	Left	Right	R NA	Left	Left	Right	Left	Left	Right	Left
Median Width(ft)		24				24				24		
Link Offset(ft)		0				0				0		
Crosswalk Width(ft)		16				16				16		
Two way Left Turn Lane												
Headway Factor	1.00	1.00	1.00	1.00	1.00	1.00	1.00	1.00	1.00	1.00	1.00	1.00
Turning Speed (mph)	9	15		9	9	15		9	15		9	15
Number of Detectors	1	1	1		1	1	1		1	1		1
Detector Template												
Leading Detector (ft)	50	50	50		50	50	50		50	50		50
Trailing Detector (ft)	0	0	0		0	0	0		0	0		0
Detector 1 Position(ft)	0	0	0		0	0	0		0	0		0
Detector 1 Size(ft)	50	50	50		50	50	50		50	50		50
Detector 1 Type	Cl+Ex	Cl+Ex	Cl+Ex		Cl+Ex	Cl+Ex	Cl+Ex		Cl+Ex	Cl+Ex		Cl+Ex
Detector 1 Channel												
Detector 1 Extend (s)	0.0	0.0	0.0		0.0	0.0	0.0		0.0	0.0		0.0
Detector 1 Queue (s)	0.0	0.0	0.0		0.0	0.0	0.0		0.0	0.0		0.0
Detector 1 Delay (s)	0.0	0.0	0.0		0.0	0.0	0.0		0.0	0.0		0.0
Turn Type	D.P+P	D.P+P	NA		custom	D.P+P	NA		Split	NA		Split
Protected Phases	1	1	6			5	2		3	3		4
Permitted Phases	2	2			5	6						
Detector Phase	1	1	6		5	5	2		3	3		4
Switch Phase												
Minimum Initial (s)	3.0	3.0	15.0		3.0	3.0	15.0		5.0	5.0		7.0
Minimum Split (s)	8.0	8.0	22.0		8.0	8.0	24.0		23.0	23.0		23.2
Total Split (s)	25.0	25.0	99.0		15.0	15.0	89.0		18.0	18.0		28.0

Pepper Square TIA  
Lanes, Volumes, Timings

2021 - Existing - PM  
1405: Prestonwood & Belt Line



Lane Group	SBT	SBR
Lane Configurations	↔	↔
Traffic Volume (vph)	2	80
Future Volume (vph)	2	80
Ideal Flow (vphpl)	1900	1900
Storage Length (ft)		0
Storage Lanes		1
Taper Length (ft)		
Lane Util. Factor	0.95	0.95
Fr	0.857	0.850
Flt Protected		
Satd. Flow (prot)	1517	1504
Flt Permitted		
Satd. Flow (perm)	1517	1504
Right Turn on Red		Yes
Satd. Flow (RTOR)	41	89
Link Speed (mph)	30	
Link Distance (ft)	868	
Travel Time (s)	19.7	
Peak Hour Factor	0.95	0.95
Adj. Flow (vph)	2	84
Shared Lane Traffic (%)		49%
Lane Group Flow (vph)	43	43
Enter Blocked Intersection	No	No
Lane Alignment	Left	Right
Median Width(ft)	24	
Link Offset(ft)	0	
Crosswalk Width(ft)	16	
Two way Left Turn Lane		
Headway Factor	1.00	1.00
Turning Speed (mph)	9	
Number of Detectors	1	1
Detector Template		
Leading Detector (ft)	50	50
Trailing Detector (ft)	0	0
Detector 1 Position(ft)	0	0
Detector 1 Size(ft)	50	50
Detector 1 Type	Cl+Ex	Cl+Ex
Detector 1 Channel		
Detector 1 Extend (s)	0.0	0.0
Detector 1 Queue (s)	0.0	0.0
Detector 1 Delay (s)	0.0	0.0
Turn Type	NA	custom
Protected Phases	4	
Permitted Phases		1 4
Detector Phase	4	1 4
Switch Phase		
Minimum Initial (s)	7.0	
Minimum Split (s)	23.2	
Total Split (s)	28.0	

Pepper Square TIA  
Lanes, Volumes, Timings

2021 - Existing - PM  
1405: Prestonwood & Belt Line



Lane Group	EBU	EBL	EBT	EBR	WBU	WBL	WBT	WBR	NBL	NBT	NBR	SBL
Total Split (%)	15.6%	15.6%	61.9%		9.4%	9.4%	55.6%		11.3%	11.3%		17.5%
Maximum Green (s)	20.0	20.0	93.0		10.0	10.0	83.0		13.0	13.0		22.8
Yellow Time (s)	3.0	3.0	4.5		3.0	3.0	4.5		3.0	3.0		3.2
All-Red Time (s)	2.0	2.0	1.5		2.0	2.0	1.5		2.0	2.0		2.0
Lost Time Adjust (s)		-1.0	-2.0			-1.0	-2.0			-1.0		-1.2
Total Lost Time (s)		4.0	4.0			4.0	4.0			4.0		4.0
Lead/Lag	Lag	Lag	Lag		Lead	Lead	Lead		Lead	Lead		Lag
Lead-Lag Optimize?	Yes	Yes	Yes		Yes	Yes	Yes		Yes	Yes		Yes
Vehicle Extension (s)	1.0	1.0	2.5		1.0	1.0	2.5		1.5	1.5		1.5
Recall Mode	None	None	C-Max		None	None	None		None	None		None
Walk Time (s)			5.0				4.0		4.0	4.0		4.0
Flash Dont Walk (s)			10.0				14.0		14.0	14.0		14.0
Pedestrian Calls (#/hr)			0				0		0	0		0
Act Effct Green (s)		131.4	133.7			134.6	72.2			6.3		12.3
Actuated g/C Ratio		0.82	0.84			0.84	0.45			0.04		0.08
v/c Ratio		0.12	0.37			0.02	0.61			0.13		0.59
Control Delay		13.9	4.4			0.8	21.3			67.0		80.2
Queue Delay		0.0	0.0			0.0	0.0			0.0		0.0
Total Delay		13.9	4.4			0.8	21.3			67.0		80.2
LOS		B	A			A	C			E		F
Approach Delay			4.9				21.2			67.0		
Approach LOS			A				C			E		
90th %ile Green (s)	46.7	46.7	114.2		3.8	3.8	71.3		6.2	6.2		14.6
90th %ile Term Code	Hold	Hold	Coord		Gap	Gap	Coord		Gap	Gap		Gap
70th %ile Green (s)	56.5	56.5	126.1		0.0	0.0	64.6		5.2	5.2		12.5
70th %ile Term Code	Hold	Hold	Coord		Skip	Skip	Coord		Gap	Gap		Gap
50th %ile Green (s)	59.3	59.3	137.7		0.0	0.0	73.4		0.0	0.0		11.1
50th %ile Term Code	Hold	Hold	Coord		Skip	Skip	Coord		Skip	Skip		Gap
30th %ile Green (s)	62.1	62.1	139.1		0.0	0.0	72.0		0.0	0.0		9.7
30th %ile Term Code	Hold	Hold	Coord		Skip	Skip	Coord		Skip	Skip		Gap
10th %ile Green (s)	66.7	66.7	141.2		0.0	0.0	69.5		0.0	0.0		7.6
10th %ile Term Code	Hold	Hold	Coord		Skip	Skip	Coord		Skip	Skip		Gap
Queue Length 50th (ft)		8	37			0	179			7		81
Queue Length 95th (ft)		50	367			m1	m301			28		119
Internal Link Dist (ft)			1365				1956			235		
Turn Bay Length (ft)		200				200						300
Base Capacity (vph)		727	4243			314	2675			154		514
Starvation Cap Reductn		0	0			0	0			0		0
Spillback Cap Reductn		0	0			0	0			0		0
Storage Cap Reductn		0	0			0	0			0		0
Reduced v/c Ratio		0.12	0.37			0.02	0.52			0.06		0.30

Intersection Summary  
 Area Type: Other  
 Cycle Length: 160  
 Actuated Cycle Length: 160  
 Offset: 60 (38%), Referenced to phase 6:EBWB, Start of Yellow  
 Natural Cycle: 80  
 Control Type: Actuated-Coordinated

Pepper Square TIA  
Lanes, Volumes, Timings

2021 - Existing - PM  
1405: Prestonwood & Belt Line



Lane Group	SBT	SBR
Total Split (%)	17.5%	
Maximum Green (s)	22.8	
Yellow Time (s)	3.2	
All-Red Time (s)	2.0	
Lost Time Adjust (s)	-1.2	
Total Lost Time (s)	4.0	
Lead/Lag	Lag	
Lead-Lag Optimize?	Yes	
Vehicle Extension (s)	1.5	
Recall Mode	None	
Walk Time (s)	4.0	
Flash Dont Walk (s)	14.0	
Pedestrian Calls (#/hr)	0	
Act Effct Green (s)	12.3	74.0
Actuated g/C Ratio	0.08	0.46
v/c Ratio	0.28	0.06
Control Delay	23.8	0.1
Queue Delay	0.0	0.0
Total Delay	23.8	0.1
LOS	C	A
Approach Delay	55.7	
Approach LOS	E	
90th %ile Green (s)	14.6	
90th %ile Term Code	Gap	
70th %ile Green (s)	12.5	
70th %ile Term Code	Gap	
50th %ile Green (s)	11.1	
50th %ile Term Code	Gap	
30th %ile Green (s)	9.7	
30th %ile Term Code	Gap	
10th %ile Green (s)	7.6	
10th %ile Term Code	Gap	
Queue Length 50th (ft)	2	0
Queue Length 95th (ft)	46	0
Internal Link Dist (ft)	788	
Turn Bay Length (ft)		
Base Capacity (vph)	262	846
Starvation Cap Reductn	0	0
Spillback Cap Reductn	0	0
Storage Cap Reductn	0	0
Reduced v/c Ratio	0.16	0.05

Intersection Summary

Pepper Square TIA  
Lanes, Volumes, Timings

2021 - Existing - PM  
1405: Prestonwood & Belt Line

Maximum v/c Ratio: 0.61	
Intersection Signal Delay: 15.6	Intersection LOS: B
Intersection Capacity Utilization 51.4%	ICU Level of Service A
Analysis Period (min) 15	
m Volume for 95th percentile queue is metered by upstream signal.	

Splits and Phases: 1405: Prestonwood & Belt Line

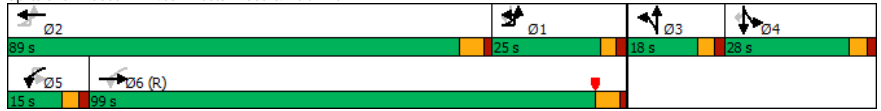

Pepper Square TIA  
HCM 6th TWSC

2021 - Existing - PM  
3: Median Opening East of Preston Rd & Belt Line

Intersection														
Int Delay, s/veh	0.7													
Movement	EBU	EBL	EBT	EBR	WBU	WBL	WBT	WBR	NBL	NBT	NBR	SBL	SBT	SBR
Lane Configurations		↑ ↑ ↑				↑ ↑ ↑				↕			↕	
Traffic Vol, veh/h	6	6	1134	12	1	13	830	5	2	0	2	20	1	21
Future Vol, veh/h	6	6	1134	12	1	13	830	5	2	0	2	20	1	21
Conflicting Peds, #/hr	0	0	0	0	0	0	0	0	0	0	0	0	0	0
Sign Control	Free	Free	Free	Free	Free	Free	Free	Free	Stop	Stop	Stop	Stop	Stop	Stop
RT Channelized	-	-	-	None	-	-	None	-	-	None	-	-	None	-
Storage Length	-	150	-	-	-	200	-	-	-	-	-	-	-	-
Veh in Median Storage, #	-	-	0	-	-	-	0	-	-	1	-	-	1	-
Grade, %	-	-	0	-	-	-	0	-	-	0	-	-	0	-
Peak Hour Factor	93	93	93	93	93	93	93	93	93	93	93	93	93	93
Heavy Vehicles, %	2	2	2	2	2	2	2	2	2	2	2	2	2	2
Mvmt Flow	6	6	1219	13	1	14	892	5	2	0	2	22	1	23

Major/Minor	Major1		Major2		Minor1		Minor2							
Conflicting Flow All	655	897	0	0	900	1232	0	0	1637	2177	616	1437	2181	449
Stage 1	-	-	-	-	-	-	-	-	1250	1250	-	925	925	-
Stage 2	-	-	-	-	-	-	-	-	387	927	-	512	1256	-
Critical Hdwy	5.64	5.34	-	-	5.64	5.34	-	-	6.44	6.54	7.14	6.44	6.54	7.14
Critical Hdwy Stg 1	-	-	-	-	-	-	-	-	7.34	5.54	-	7.34	5.54	-
Critical Hdwy Stg 2	-	-	-	-	-	-	-	-	6.74	5.54	-	6.74	5.54	-
Follow-up Hdwy	2.32	3.12	-	-	2.32	3.12	-	-	3.82	4.02	3.92	3.82	4.02	3.92
Pot Cap-1 Maneuver	682	439	-	-	499	302	-	-	106	46	372	140	45	477
Stage 1	-	-	-	-	-	-	-	-	133	243	-	224	346	-
Stage 2	-	-	-	-	-	-	-	-	557	345	-	468	241	-
Platoon blocked, %	-	-	-	-	-	-	-	-	-	-	-	-	-	-
Mov Cap-1 Maneuver	525	525	-	-	311	311	-	-	95	43	372	132	42	477
Mov Cap-2 Maneuver	-	-	-	-	-	-	-	-	116	143	-	182	139	-
Stage 1	-	-	-	-	-	-	-	-	130	237	-	218	329	-
Stage 2	-	-	-	-	-	-	-	-	503	328	-	454	235	-

Approach	EB	WB	NB	SB
HCM Control Delay, s	0.1	0.3	25.8	21.7
HCM LOS	D	B	D	C

Minor Lane/Major Mvmt	NBLn1	EBL	EBT	EBR	WBL	WBT	WBR	SBLn1
Capacity (veh/h)	177	525	-	-	311	-	-	261
HCM Lane V/C Ratio	0.024	0.025	-	-	0.048	-	-	0.173
HCM Control Delay (s)	25.8	12	-	-	17.2	-	-	21.7
HCM Lane LOS	D	B	-	-	C	-	-	C
HCM 95th %tile Q(veh)	0.1	0.1	-	-	0.2	-	-	0.6

Pepper Square TIA  
HCM 6th TWSC

2021 - Existing - PM  
4: Berry Trail & Belt Line

Intersection													
Int Delay, s/veh	1.4												
Movement	EBL	EBT	EBR	WBL	WBT	WBR	NBL	NBT	NBR	SBL	SBT	SBR	
Lane Configurations	↑ ↑ ↑			↑ ↑ ↑			↑	↑		↑	↑		
Traffic Vol, veh/h	39	1125	14	18	808	31	3	9	4	26	6	33	
Future Vol, veh/h	39	1125	14	18	808	31	3	9	4	26	6	33	
Conflicting Peds, #/hr	0	0	0	0	0	0	0	0	0	0	0	0	
Sign Control	Free	Free	Free	Free	Free	Free	Stop	Stop	Stop	Stop	Stop	Stop	
RT Channelized	-	-	None	-	-	None	-	-	None	-	-	None	
Storage Length	150	-	-	150	-	-	0	-	-	0	-	-	
Veh in Median Storage, #	-	0	-	-	0	-	-	1	-	-	1	-	
Grade, %	-	0	-	-	0	-	-	0	-	-	0	-	
Peak Hour Factor	94	94	94	94	94	94	94	94	94	94	94	94	
Heavy Vehicles, %	2	2	2	2	2	2	2	2	2	2	2	2	
Mvmt Flow	41	1197	15	19	860	33	3	10	4	28	6	35	

Major/Minor	Major1		Major2		Minor1		Minor2					
Conflicting Flow All	893	0	0	1212	0	0	1672	2218	606	1481	2209	447
Stage 1	-	-	-	-	-	-	1287	1287	-	915	915	-
Stage 2	-	-	-	-	-	-	385	931	-	566	1294	-
Critical Hdwy	5.34	-	-	5.34	-	-	6.44	6.54	7.14	6.44	6.54	7.14
Critical Hdwy Stg 1	-	-	-	-	-	-	7.34	5.54	-	7.34	5.54	-
Critical Hdwy Stg 2	-	-	-	-	-	-	6.74	5.54	-	6.74	5.54	-
Follow-up Hdwy	3.12	-	-	3.12	-	-	3.82	4.02	3.92	3.82	4.02	3.92
Pot Cap-1 Maneuver	441	-	-	309	-	-	101	43	377	132	44	478
Stage 1	-	-	-	-	-	-	125	233	-	228	350	-
Stage 2	-	-	-	-	-	-	558	344	-	434	231	-
Platoon blocked, %	-	-	-	-	-	-	-	-	-	-	-	-
Mov Cap-1 Maneuver	441	-	-	309	-	-	80	37	377	109	37	478
Mov Cap-2 Maneuver	-	-	-	-	-	-	101	127	-	163	126	-
Stage 1	-	-	-	-	-	-	113	211	-	207	329	-
Stage 2	-	-	-	-	-	-	476	323	-	372	210	-

Approach	EB	WB	NB	SB
HCM Control Delay, s	0.5	0.4	31.9	23
HCM LOS	D	B	D	C

Minor Lane/Major Mvmt	NBLn1	NBLn2	EBL	EBT	EBR	WBL	WBT	WBR	SBLn1	SBLn2
Capacity (veh/h)	101	160	441	-	-	309	-	-	163	334
HCM Lane V/C Ratio	0.032	0.086	0.094	-	-	0.062	-	-	0.17	0.124
HCM Control Delay (s)	41.8	29.6	14	-	-	17.4	-	-	31.5	17.3
HCM Lane LOS	E	D	B	-	-	C	-	-	D	C
HCM 95th %tile Q(veh)	0.1	0.3	0.3	-	-	0.2	-	-	0.6	0.4

Pepper Square TIA  
HCM 6th TWSC

2021 - Existing - PM  
5: Belt Line & Median between Berry Trail and Alexis Dr

Intersection												
Int Delay, s/veh	0.6											
Movement	EBL	EBT	EBR	WBL	WBT	WBR	NBL	NBT	NBR	SBL	SBT	SBR
Lane Configurations	↕ ↑↑↑			↕ ↑↑↑			↕			↕		
Traffic Vol, veh/h	8	1188	2	26	837	12	3	4	11	4	1	7
Future Vol, veh/h	8	1188	2	26	837	12	3	4	11	4	1	7
Conflicting Peds, #/hr	0	0	0	0	0	0	0	0	0	0	0	0
Sign Control	Free	Free	Free	Free	Free	Free	Stop	Stop	Stop	Stop	Stop	Stop
RT Channelized	-	-	None	-	-	None	-	-	None	-	-	None
Storage Length	150	-	-	150	-	-	-	-	-	-	-	-
Veh in Median Storage, #	-	0	-	-	0	-	-	1	-	-	1	-
Grade, %	-	0	-	-	0	-	-	0	-	-	0	-
Peak Hour Factor	94	94	94	94	94	94	94	94	94	94	94	94
Heavy Vehicles, %	2	2	2	2	2	2	2	2	2	2	2	2
Mvmt Flow	9	1264	2	28	890	13	3	4	12	4	1	7

Major/Minor	Major1	Major2	Minor1	Minor2
Conflicting Flow All	903	0	0	1266
Stage 1	-	-	-	-
Stage 2	-	-	-	-
Critical Hdwy	5.34	-	-	5.34
Critical Hdwy Stg 1	-	-	-	-
Critical Hdwy Stg 2	-	-	-	-
Follow-up Hdwy	3.12	-	-	3.12
Pot Cap-1 Maneuver	910	-	-	291
Stage 1	-	-	-	-
Stage 2	-	-	-	-
Platoon blocked, %	1	-	-	1
Mov Cap-1 Maneuver	910	-	-	291
Mov Cap-2 Maneuver	-	-	-	-
Stage 1	-	-	-	-
Stage 2	-	-	-	-

Approach	EB	WB	NB	SB
HCM Control Delay, s	0.1	0.6	22.8	13.6
HCM LOS			C	B

Minor Lane/Major Mvmt	NBLn1	EBL	EBT	EBR	WBL	WBT	WBR	SBLn1
Capacity (veh/h)	221	910	-	-	291	-	-	433
HCM Lane V/C Ratio	0.087	0.009	-	-	0.095	-	-	0.029
HCM Control Delay (s)	22.8	9	-	-	18.7	-	-	13.6
HCM Lane LOS	C	A	-	-	C	-	-	B
HCM 95th %tile Q(veh)	0.3	0	-	-	0.3	-	-	0.1

Notes  
 -: Volume exceeds capacity    \$: Delay exceeds 300s    +: Computation Not Defined    \*: All major volume in platoon

Pepper Square TIA  
HCM 6th TWSC

2021 - Existing - PM  
6: Alexis Drive & Belt Line

Intersection						
Int Delay, s/veh	8.1					
Movement	EBT	EBR	WBL	WBT	NBL	NBR
Lane Configurations	↑↑↑		↕ ↑↑↑		↕ ↕	
Traffic Vol, veh/h	1179	10	184	866	1	285
Future Vol, veh/h	1179	10	184	866	1	285
Conflicting Peds, #/hr	0	0	0	0	0	0
Sign Control	Free	Free	Free	Free	Stop	Stop
RT Channelized	-	None	-	None	-	Yield
Storage Length	-	-	150	-	0	0
Veh in Median Storage, #	0	-	-	0	1	-
Grade, %	0	-	-	0	0	-
Peak Hour Factor	95	95	95	95	95	95
Heavy Vehicles, %	2	2	2	2	2	2
Mvmt Flow	1241	11	194	912	1	300

Major/Minor	Major1	Major2	Minor1
Conflicting Flow All	0	0	1252
Stage 1	-	-	-
Stage 2	-	-	-
Critical Hdwy	-	-	5.34
Critical Hdwy Stg 1	-	-	-
Critical Hdwy Stg 2	-	-	-
Follow-up Hdwy	-	-	3.12
Pot Cap-1 Maneuver	-	-	295
Stage 1	-	-	-
Stage 2	-	-	-
Platoon blocked, %	-	-	-
Mov Cap-1 Maneuver	-	-	295
Mov Cap-2 Maneuver	-	-	-
Stage 1	-	-	-
Stage 2	-	-	-

Approach	EB	WB	NB
HCM Control Delay, s	0	6.6	46.9
HCM LOS			E

Minor Lane/Major Mvmt	NBLn1	NBLn2	EBT	EBR	WBL	WBT
Capacity (veh/h)	118	366	-	-	295	-
HCM Lane V/C Ratio	0.009	0.82	-	-	0.657	-
HCM Control Delay (s)	35.8	46.9	-	-	37.8	-
HCM Lane LOS	E	E	-	-	E	-
HCM 95th %tile Q(veh)	0	7.3	-	-	4.3	-

Notes  
 -: Volume exceeds capacity    \$: Delay exceeds 300s    +: Computation Not Defined    \*: All major volume in platoon

Pepper Square TIA  
HCM 6th TWSC

2021 - Existing - PM  
10: Preston & Pepper Square Driveway

Intersection													
Int Delay, s/veh	5.2												
Movement	EBL	EBT	EBR	WBL	WBT	WBR	NBL	NBT	NBR	SBL	SBT	SBR	
Lane Configurations		↕		↕			↕	↕↕↕		↕	↕↕↕		
Traffic Vol, veh/h	11	5	59	9	2	52	4	92	2152	33	6	23	1663
Future Vol, veh/h	11	5	59	9	2	52	4	92	2152	33	6	23	1663
Conflicting Peds, #/hr	0	0	0	0	0	0	0	0	0	0	0	0	0
Sign Control	Stop	Stop	Stop	Stop	Stop	Stop	Free	Free	Free	Free	Free	Free	Free
RT Channelized	-	-	None	-	-	None	-	-	None	-	-	-	None
Storage Length	-	-	-	-	-	-	-	150	-	-	150	-	-
Veh in Median Storage, #	-	1	-	-	1	-	-	0	-	-	0	-	-
Grade, %	-	0	-	-	0	-	-	0	-	-	0	-	-
Peak Hour Factor	97	97	97	97	97	97	97	97	97	97	97	97	97
Heavy Vehicles, %	2	2	2	2	2	2	2	2	2	2	2	2	2
Mvmt Flow	11	5	61	9	2	54	4	95	2219	34	6	24	1714

Major/Minor	Minor2	Minor1	Major1	Major2									
Conflicting Flow All	2896	4260	892	3182	4277	1127	1302	1783	0	0	1644	2253	0
Stage 1	1809	1809	-	2434	2434	-	-	-	-	-	-	-	-
Stage 2	1087	2451	-	748	1843	-	-	-	-	-	-	-	-
Critical Hdwy	6.44	6.54	7.14	6.44	6.54	7.14	5.64	5.34	-	-	5.64	5.34	-
Critical Hdwy Stg 1	7.34	5.54	-	7.34	5.54	-	-	-	-	-	-	-	-
Critical Hdwy Stg 2	6.74	5.54	-	6.74	5.54	-	-	-	-	-	-	-	-
Follow-up Hdwy	3.82	4.02	3.92	3.82	4.02	3.92	2.32	3.12	-	-	2.32	3.12	-
Pot Cap-1 Maneuver	*51	*-1	*541	*25	*-1	171	*915	*681	-	-	192	93	-
Stage 1	*555	*528	-	*18	*62	-	-	-	-	-	-	-	-
Stage 2	*208	*60	-	*555	*528	-	-	-	-	-	-	-	-
Platoon blocked, %	1	1	1	1	1	1	1	1	-	-	-	-	-
Mov Cap-1 Maneuver	*23	*-1	*541	*12	*-1	171	*686	*686	-	-	99	99	-
Mov Cap-2 Maneuver	*72	*18	-	*14	*41	-	-	-	-	-	-	-	-
Stage 1	*475	*369	-	*15	*53	-	-	-	-	-	-	-	-
Stage 2	*117	*51	-	*339	*369	-	-	-	-	-	-	-	-

Approach	EB	WB	NB	SB
HCM Control Delay, s	59.3	232.1	0.5	0.9
HCM LOS	F	F		

Minor Lane/Major Mvmt	NBL	NBT	NBR	EBLn1	WBLn1	SBL	SBT	SBR
Capacity (veh/h)	*686	-	-	139	63	99	-	-
HCM Lane V/C Ratio	0.144	-	-	0.556	1.031	0.302	-	-
HCM Control Delay (s)	11.1	-	-	59.3	232.1	56.2	-	-
HCM Lane LOS	B	-	-	F	F	F	-	-
HCM 95th %tile Q(veh)	0.5	-	-	2.8	5.1	1.1	-	-

Notes  
 -: Volume exceeds capacity    \$: Delay exceeds 300s    +: Computation Not Defined    \*: All major volume in platoon

Pepper Square TIA  
HCM 6th TWSC

2021 - Existing - PM  
20: Preston & Drive 2

Intersection						
Int Delay, s/veh	0.1					
Movement	WBL	WBR	NBT	NBR	SBL	SBT
Lane Configurations		↕	↕↕↕			↕↕↕
Traffic Vol, veh/h	0	14	2198	8	0	1842
Future Vol, veh/h	0	14	2198	8	0	1842
Conflicting Peds, #/hr	0	0	0	0	0	0
Sign Control	Stop	Stop	Free	Free	Free	Free
RT Channelized	-	None	-	None	-	None
Storage Length	-	0	-	-	-	-
Veh in Median Storage, #	0	-	0	-	-	0
Grade, %	0	-	0	-	-	0
Peak Hour Factor	95	95	95	95	95	95
Heavy Vehicles, %	2	2	2	2	2	2
Mvmt Flow	0	15	2314	8	0	1939

Major/Minor	Minor1	Major1	Major2				
Conflicting Flow All	-	1161	0	0	-	-	-
Stage 1	-	-	-	-	-	-	-
Stage 2	-	-	-	-	-	-	-
Critical Hdwy	-	7.14	-	-	-	-	-
Critical Hdwy Stg 1	-	-	-	-	-	-	-
Critical Hdwy Stg 2	-	-	-	-	-	-	-
Follow-up Hdwy	-	3.92	-	-	-	-	-
Pot Cap-1 Maneuver	0	162	-	-	0	-	-
Stage 1	0	-	-	-	0	-	-
Stage 2	0	-	-	-	0	-	-
Platoon blocked, %	-	-	-	-	-	-	-
Mov Cap-1 Maneuver	-	162	-	-	-	-	-
Mov Cap-2 Maneuver	-	-	-	-	-	-	-
Stage 1	-	-	-	-	-	-	-
Stage 2	-	-	-	-	-	-	-

Approach	WB	NB	SB
HCM Control Delay, s	29.4	0	0
HCM LOS	D		

Minor Lane/Major Mvmt	NBT	NBR	WBLn1	SBT
Capacity (veh/h)	-	-	162	-
HCM Lane V/C Ratio	-	-	0.091	-
HCM Control Delay (s)	-	-	29.4	-
HCM Lane LOS	-	-	D	-
HCM 95th %tile Q(veh)	-	-	0.3	-



Pepper Square TIA  
HCM 6th TWSC

2021 - Existing - PM  
21: Preston & Drive 1

Intersection						
Int Delay, s/veh	0					
Movement	WBL	WBR	NBT	NBR	SBL	SBT
Lane Configurations		↑↑↑	↑↑↑			↑↑↑
Traffic Vol, veh/h	0	2	2281	2	0	1684
Future Vol, veh/h	0	2	2281	2	0	1684
Conflicting Peds, #/hr	0	0	0	0	0	0
Sign Control	Stop	Stop	Free	Free	Free	Free
RT Channelized	-	None	-	None	-	None
Storage Length	-	0	-	-	-	-
Veh in Median Storage, #	0	-	0	-	-	0
Grade, %	0	-	0	-	-	0
Peak Hour Factor	95	95	95	95	95	95
Heavy Vehicles, %	2	2	2	2	2	2
Mvmt Flow	0	2	2401	2	0	1773

Major/Minor	Minor1	Major1	Major2		
Conflicting Flow All	-	1202	0	0	-
Stage 1	-	-	-	-	-
Stage 2	-	-	-	-	-
Critical Hdwy	-	7.14	-	-	-
Critical Hdwy Stg 1	-	-	-	-	-
Critical Hdwy Stg 2	-	-	-	-	-
Follow-up Hdwy	-	3.92	-	-	-
Pot Cap-1 Maneuver	0	152	-	0	-
Stage 1	0	-	-	0	-
Stage 2	0	-	-	0	-
Platoon blocked, %	-	-	-	-	-
Mov Cap-1 Maneuver	-	152	-	-	-
Mov Cap-2 Maneuver	-	-	-	-	-
Stage 1	-	-	-	-	-
Stage 2	-	-	-	-	-

Approach	WB	NB	SB
HCM Control Delay, s	29	0	0
HCM LOS	D		

Minor Lane/Major Mvmt	NBT	NBRWBLn1	SBT
Capacity (veh/h)	-	-	152
HCM Lane V/C Ratio	-	-	0.014
HCM Control Delay (s)	-	-	29
HCM Lane LOS	-	-	D
HCM 95th %tile Q(veh)	-	-	0

Pepper Square TIA  
HCM 6th TWSC

2021 - Existing - PM  
22: Drive 6 & Belt Line

Intersection						
Int Delay, s/veh	0.1					
Movement	EBT	EBR	WBL	WBT	NBL	NBR
Lane Configurations	↑↑↑			↑↑↑		↑
Traffic Vol, veh/h	1179	8	0	844	0	8
Future Vol, veh/h	1179	8	0	844	0	8
Conflicting Peds, #/hr	0	0	0	0	0	0
Sign Control	Free	Free	Free	Free	Stop	Stop
RT Channelized	-	None	-	None	-	None
Storage Length	-	-	-	-	-	0
Veh in Median Storage, #	0	-	-	0	0	-
Grade, %	0	-	-	0	0	-
Peak Hour Factor	93	93	93	93	93	93
Heavy Vehicles, %	2	2	2	2	2	2
Mvmt Flow	1268	9	0	908	0	9

Major/Minor	Major1	Major2	Minor1		
Conflicting Flow All	0	0	-	-	639
Stage 1	-	-	-	-	-
Stage 2	-	-	-	-	-
Critical Hdwy	-	-	-	-	7.14
Critical Hdwy Stg 1	-	-	-	-	-
Critical Hdwy Stg 2	-	-	-	-	-
Follow-up Hdwy	-	-	-	-	3.92
Pot Cap-1 Maneuver	-	-	0	-	359
Stage 1	-	-	0	-	0
Stage 2	-	-	0	-	0
Platoon blocked, %	-	-	-	-	-
Mov Cap-1 Maneuver	-	-	-	-	359
Mov Cap-2 Maneuver	-	-	-	-	-
Stage 1	-	-	-	-	-
Stage 2	-	-	-	-	-

Approach	EB	WB	NB
HCM Control Delay, s	0	0	15.3
HCM LOS			C

Minor Lane/Major Mvmt	NBLn1	EBT	EBR	WBT
Capacity (veh/h)	359	-	-	-
HCM Lane V/C Ratio	0.024	-	-	-
HCM Control Delay (s)	15.3	-	-	-
HCM Lane LOS	C	-	-	-
HCM 95th %tile Q(veh)	0.1	-	-	-

Pepper Square TIA  
HCM 6th TWSC

2021 - Existing - PM  
23: Drive 7 & Belt Line

Intersection						
Int Delay, s/veh	0.2					
Movement	EBT	EBR	WBL	WBT	NBL	NBR
Lane Configurations	↑↑↑			↑↑↑		↑
Traffic Vol, veh/h	1155	4	0	856	0	25
Future Vol, veh/h	1155	4	0	856	0	25
Conflicting Peds, #/hr	0	0	0	0	0	0
Sign Control	Free	Free	Free	Free	Stop	Stop
RT Channelized	-	None	-	None	-	None
Storage Length	-	-	-	-	-	0
Veh in Median Storage, #	0	-	-	0	0	-
Grade, %	0	-	-	0	0	-
Peak Hour Factor	93	93	93	93	93	93
Heavy Vehicles, %	2	2	2	2	2	2
Mvmt Flow	1242	4	0	920	0	27

Major/Minor	Major1	Major2	Minor1
Conflicting Flow All	0	0	623
Stage 1	-	-	-
Stage 2	-	-	-
Critical Hdwy	-	-	7.14
Critical Hdwy Stg 1	-	-	-
Critical Hdwy Stg 2	-	-	-
Follow-up Hdwy	-	-	3.92
Pot Cap-1 Maneuver	-	0	368
Stage 1	-	0	0
Stage 2	-	0	0
Platoon blocked, %	-	-	-
Mov Cap-1 Maneuver	-	-	368
Mov Cap-2 Maneuver	-	-	-
Stage 1	-	-	-
Stage 2	-	-	-

Approach	EB	WB	NB
HCM Control Delay, s	0	0	15.6
HCM LOS			C

Minor Lane/Major Mvmt	NBLn1	EBT	EBR	WBT
Capacity (veh/h)	368	-	-	-
HCM Lane V/C Ratio	0.073	-	-	-
HCM Control Delay (s)	15.6	-	-	-
HCM Lane LOS	C	-	-	-
HCM 95th %tile Q(veh)	0.2	-	-	-

Pepper Square TIA  
HCM 6th TWSC

2021 - Existing - PM  
24: Drive 5 & Belt Line

Intersection						
Int Delay, s/veh	0					
Movement	EBT	EBR	WBL	WBT	NBL	NBR
Lane Configurations	↑↑↑			↑↑↑		↑
Traffic Vol, veh/h	1162	0	0	801	0	5
Future Vol, veh/h	1162	0	0	801	0	5
Conflicting Peds, #/hr	0	0	0	0	0	0
Sign Control	Free	Free	Free	Free	Stop	Stop
RT Channelized	-	None	-	None	-	None
Storage Length	-	-	-	-	-	0
Veh in Median Storage, #	0	-	-	0	0	-
Grade, %	0	-	-	0	0	-
Peak Hour Factor	93	93	93	93	93	93
Heavy Vehicles, %	2	2	2	2	2	2
Mvmt Flow	1249	0	0	861	0	5

Major/Minor	Major1	Major2	Minor1
Conflicting Flow All	0	0	625
Stage 1	-	-	-
Stage 2	-	-	-
Critical Hdwy	-	-	7.14
Critical Hdwy Stg 1	-	-	-
Critical Hdwy Stg 2	-	-	-
Follow-up Hdwy	-	-	3.92
Pot Cap-1 Maneuver	-	0	367
Stage 1	-	0	0
Stage 2	-	0	0
Platoon blocked, %	-	-	-
Mov Cap-1 Maneuver	-	-	367
Mov Cap-2 Maneuver	-	-	-
Stage 1	-	-	-
Stage 2	-	-	-

Approach	EB	WB	NB
HCM Control Delay, s	0	0	15
HCM LOS			C

Minor Lane/Major Mvmt	NBLn1	EBT	EBR	WBT
Capacity (veh/h)	367	-	-	-
HCM Lane V/C Ratio	0.015	-	-	-
HCM Control Delay (s)	15	-	-	-
HCM Lane LOS	C	-	-	-
HCM 95th %tile Q(veh)	0	-	-	-

Pepper Square TIA  
HCM 6th TWSC

2021 - Existing - PM  
25: Preston & Drive 4

Intersection						
Int Delay, s/veh	0.1					
Movement	WBL	WBR	NBT	NBR	SBL	SBT
Lane Configurations		↑ ↑ ↑				↑ ↑ ↑
Traffic Vol, veh/h	0	10	2282	9	0	1842
Future Vol, veh/h	0	10	2282	9	0	1842
Conflicting Peds, #/hr	0	0	0	0	0	0
Sign Control	Stop	Stop	Free	Free	Free	Free
RT Channelized	-	None	-	None	-	None
Storage Length	-	0	-	-	-	-
Veh in Median Storage, #	0	-	0	-	-	0
Grade, %	0	-	0	-	-	0
Peak Hour Factor	95	95	95	95	95	95
Heavy Vehicles, %	2	2	2	2	2	2
Mvmt Flow	0	11	2402	9	0	1939

Major/Minor	Minor1	Major1	Major2
Conflicting Flow All	- 1206	0	0 - -
Stage 1	- -	-	- - -
Stage 2	- -	-	- - -
Critical Hdwy	- 7.14	-	- - -
Critical Hdwy Stg 1	- -	-	- - -
Critical Hdwy Stg 2	- -	-	- - -
Follow-up Hdwy	- 3.92	-	- - -
Pot Cap-1 Maneuver	0 151	-	- 0 -
Stage 1	0 -	-	- 0 -
Stage 2	0 -	-	- 0 -
Platoon blocked, %	-	-	- - -
Mov Cap-1 Maneuver	- 151	-	- - -
Mov Cap-2 Maneuver	- -	-	- - -
Stage 1	- -	-	- - -
Stage 2	- -	-	- - -

Approach	WB	NB	SB
HCM Control Delay, s	30.6	0	0
HCM LOS	D		

Minor Lane/Major Mvmt	NBT	NBRWBLn1	SBT
Capacity (veh/h)	-	- 151	-
HCM Lane V/C Ratio	-	- 0.07	-
HCM Control Delay (s)	-	- 30.6	-
HCM Lane LOS	-	- D	-
HCM 95th %tile Q(veh)	-	- 0.2	-

Pepper Square TIA  
HCM 6th TWSC

2021 - Existing - PM  
26: Preston & Drive 3

Intersection						
Int Delay, s/veh	0.2					
Movement	WBL	WBR	NBT	NBR	SBL	SBT
Lane Configurations		↑ ↑ ↑				↑ ↑ ↑
Traffic Vol, veh/h	0	29	2282	17	0	1842
Future Vol, veh/h	0	29	2282	17	0	1842
Conflicting Peds, #/hr	0	0	0	0	0	0
Sign Control	Stop	Stop	Free	Free	Free	Free
RT Channelized	-	None	-	None	-	None
Storage Length	-	0	-	-	-	-
Veh in Median Storage, #	0	-	0	-	-	0
Grade, %	0	-	0	-	-	0
Peak Hour Factor	95	95	95	95	95	95
Heavy Vehicles, %	2	2	2	2	2	2
Mvmt Flow	0	31	2402	18	0	1939

Major/Minor	Minor1	Major1	Major2
Conflicting Flow All	- 1210	0	0 - -
Stage 1	- -	-	- - -
Stage 2	- -	-	- - -
Critical Hdwy	- 7.14	-	- - -
Critical Hdwy Stg 1	- -	-	- - -
Critical Hdwy Stg 2	- -	-	- - -
Follow-up Hdwy	- 3.92	-	- - -
Pot Cap-1 Maneuver	0 150	-	- 0 -
Stage 1	0 -	-	- 0 -
Stage 2	0 -	-	- 0 -
Platoon blocked, %	-	-	- - -
Mov Cap-1 Maneuver	- 150	-	- - -
Mov Cap-2 Maneuver	- -	-	- - -
Stage 1	- -	-	- - -
Stage 2	- -	-	- - -

Approach	WB	NB	SB
HCM Control Delay, s	35	0	0
HCM LOS	E		

Minor Lane/Major Mvmt	NBT	NBRWBLn1	SBT
Capacity (veh/h)	-	- 150	-
HCM Lane V/C Ratio	-	- 0.204	-
HCM Control Delay (s)	-	- 35	-
HCM Lane LOS	-	- E	-
HCM 95th %tile Q(veh)	-	- 0.7	-

**Synchro™ Output - 2026 Background Traffic**

Pepper Square TIA  
Lanes, Volumes, Timings

Phase 1 - 2026 - Background - AM  
4: Berry Trail & Belt Line

Lane Group	EBL	EBT	EBR	WBL	WBT	WBR	NBL	NBT	NBR	SBL	SBT	SBR
Lane Configurations	↔↔↔			↔↔↔			↔↔			↔↔		
Traffic Volume (vph)	13	490	4	3	1007	22	1	1	0	35	7	63
Future Volume (vph)	13	490	4	3	1007	22	1	1	0	35	7	63
Ideal Flow (vphpl)	1900	1900	1900	1900	1900	1900	1900	1900	1900	1900	1900	1900
Storage Length (ft)	150		0	150		0	0		0	0		0
Storage Lanes	1		0	1		0	1		0	1		0
Taper Length (ft)	25			25			25			25		
Lane Util. Factor	1.00	0.91	0.91	1.00	0.91	0.91	1.00	1.00	1.00	1.00	1.00	1.00
Frt		0.999			0.997						0.865	
Fit Protected	0.950			0.950			0.950			0.950		
Satd. Flow (prot)	1770	5080	0	1770	5070	0	1770	1863	0	1770	1611	0
Fit Permitted	0.211			0.422			0.575					
Satd. Flow (perm)	393	5080	0	786	5070	0	1071	1863	0	1863	1611	0
Right Turn on Red		Yes			Yes			Yes				Yes
Satd. Flow (RTOR)		1			3							74
Link Speed (mph)	42				42			30				30
Link Distance (ft)	234				493			277				236
Travel Time (s)	3.8				8.0			6.3				5.4
Peak Hour Factor	0.85	0.85	0.85	0.85	0.85	0.85	0.85	0.85	0.85	0.85	0.85	0.85
Adj. Flow (vph)	15	576	5	4	1185	26	1	1	0	41	8	74
Shared Lane Traffic (%)												
Lane Group Flow (vph)	15	581	0	4	1211	0	1	1	0	41	82	0
Enter Blocked Intersection	No	No	No	No	No	No	No	No	No	No	No	No
Lane Alignment	Left	Left	Right	Left	Left	Right	Left	Left	Right	Left	Left	Right
Median Width(ft)	12				12			12				12
Link Offset(ft)	0				0			0				0
Crosswalk Width(ft)	16				16			16				16
Two way Left Turn Lane												
Headway Factor	1.00	1.00	1.00	1.00	1.00	1.00	1.00	1.00	1.00	1.00	1.00	1.00
Turning Speed (mph)	15		9	15		9	15		9	15		9
Number of Detectors	1	2		1	2		1	2		1	2	
Detector Template	Left	Thru		Left	Thru		Left	Thru		Left	Thru	
Leading Detector (ft)	20	100		20	100		20	100		20	100	
Trailing Detector (ft)	0	0		0	0		0	0		0	0	
Detector 1 Position(ft)	0	0		0	0		0	0		0	0	
Detector 1 Size(ft)	20	6		20	6		20	6		20	6	
Detector 1 Type	Cl+Ex	Cl+Ex		Cl+Ex	Cl+Ex		Cl+Ex	Cl+Ex		Cl+Ex	Cl+Ex	
Detector 1 Channel												
Detector 1 Extend (s)	0.0	0.0		0.0	0.0		0.0	0.0		0.0	0.0	
Detector 1 Queue (s)	0.0	0.0		0.0	0.0		0.0	0.0		0.0	0.0	
Detector 1 Delay (s)	0.0	0.0		0.0	0.0		0.0	0.0		0.0	0.0	
Detector 2 Position(ft)	94			94			94			94		
Detector 2 Size(ft)	6			6			6			6		
Detector 2 Type	Cl+Ex			Cl+Ex			Cl+Ex			Cl+Ex		
Detector 2 Channel												
Detector 2 Extend (s)	0.0			0.0			0.0			0.0		
Turn Type	D,P+P	NA		D,P+P	NA		D,P+P	NA		D,P+P	NA	
Protected Phases	3	8		7	4		1	6		5	2	
Permitted Phases	4			8			2			6		

Pepper Square TIA  
Lanes, Volumes, Timings

Phase 1 - 2026 - Background - AM  
4: Berry Trail & Belt Line

Lane Group	EBL	EBT	EBR	WBL	WBT	WBR	NBL	NBT	NBR	SBL	SBT	SBR
Detector Phase	3	8		7	4		1	6		5	2	
Switch Phase												
Minimum Initial (s)	4.0	4.0		4.0	4.0		4.0	4.0		4.0	4.0	
Minimum Split (s)	10.0	24.0		10.0	24.0		10.0	31.0		10.0	31.0	
Total Split (s)	15.0	99.0		15.0	99.0		15.0	31.0		15.0	31.0	
Total Split (%)	9.4%	61.9%		9.4%	61.9%		9.4%	19.4%		9.4%	19.4%	
Maximum Green (s)	9.0	93.0		9.0	93.0		9.0	25.0		9.0	25.0	
Yellow Time (s)	4.0	4.0		4.0	4.0		4.0	4.0		4.0	4.0	
All-Red Time (s)	2.0	2.0		2.0	2.0		2.0	2.0		2.0	2.0	
Lost Time Adjust (s)	0.0	0.0		0.0	0.0		0.0	0.0		0.0	0.0	
Total Lost Time (s)	6.0	6.0		6.0	6.0		6.0	6.0		6.0	6.0	
Lead/Lag	Lead	Lag		Lead	Lag		Lead	Lag		Lead	Lag	
Lead-Lag Optimize?	Yes	Yes		Yes	Yes		Yes	Yes		Yes	Yes	
Vehicle Extension (s)	1.0	1.0		1.0	1.0		1.0	1.0		1.0	1.0	
Recall Mode	None	C-Max		None	C-Max		None	None		None	None	
Walk Time (s)		4.0			4.0			4.0			4.0	
Flash Dont Walk (s)		14.0			14.0			21.0			21.0	
Pedestrian Calls (#/hr)		0			0			0			0	
Act Effect Green (s)	136.5	136.9		137.7	134.9		7.9	4.2		7.9	7.1	
Actuated g/C Ratio	0.85	0.86		0.86	0.84		0.05	0.03		0.05	0.04	
v/c Ratio	0.04	0.13		0.01	0.28		0.01	0.02		0.47	0.58	
Control Delay	3.8	3.8		0.7	1.0		66.0	76.0		87.2	34.3	
Queue Delay	0.0	0.0		0.0	0.0		0.0	0.0		0.0	0.0	
Total Delay	3.8	3.8		0.7	1.0		66.0	76.0		87.2	34.3	
LOS	A	A		A	A		E	E		F	C	
Approach Delay		3.8			1.0			71.0			51.9	
Approach LOS		A			A			E			D	
Queue Length 50th (ft)	3	40		0	16		1	1		43	8	
Queue Length 95th (ft)	m8	57		m1	39		8	8		75	58	
Internal Link Dist (ft)		154			413			197			156	
Turn Bay Length (ft)	150			150								
Base Capacity (vph)	417	4346		736	4273		112	291		111	314	
Starvation Cap Reductn	0	0		0	0		0	0		0	0	
Spillback Cap Reductn	0	0		0	0		0	0		0	0	
Storage Cap Reductn	0	0		0	0		0	0		0	0	
Reduced v/c Ratio	0.04	0.13		0.01	0.28		0.01	0.00		0.37	0.26	
Intersection Summary												
Area Type:	Other											
Cycle Length:	160											
Actuated Cycle Length:	160											
Offset:	11 (7%), Referenced to phase 4:EBWB and 8:EBWB, Start of Yellow											
Natural Cycle:	75											
Control Type:	Actuated-Coordinated											
Maximum v/c Ratio:	0.58											
Intersection Signal Delay:	5.2						Intersection LOS: A					
Intersection Capacity Utilization:	38.6%						ICU Level of Service A					
Analysis Period (min):	15											
m Volume for 95th percentile queue is metered by upstream signal.												

Pepper Square TIA  
Lanes, Volumes, Timings

Phase 1 - 2026 - Background - AM  
4: Berry Trail & Belt Line

Splits and Phases: 4: Berry Trail & Belt Line

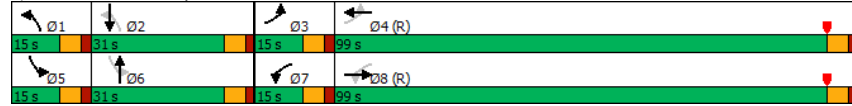

Pepper Square TIA  
Lanes, Volumes, Timings

Phase 1 - 2026 - Background - AM  
1335: Meadow Creek & Belt Line

	EBL	EBT	EBR	WBL	WBT	WBR	NBL	NBT	NBR	SBL	SBT	SBR
Lane Configurations	↑↑↑↑											
Traffic Volume (vph)	29	628	15	3	1059	17	21	3	6	8	9	81
Future Volume (vph)	29	628	15	3	1059	17	21	3	6	8	9	81
Ideal Flow (vphpl)	1900	1900	1900	1900	1900	1900	1900	1900	1900	1900	1900	1900
Storage Length (ft)	150		0	150		0	0		0	0		0
Storage Lanes	1		0	1		0	0		0	0		0
Taper Length (ft)	25			25			25			25		
Lane Util. Factor	1.00	0.91	0.91	1.00	0.91	0.91	1.00	1.00	1.00	1.00	1.00	1.00
Frt		0.997			0.998			0.975				0.889
Fit Protected	0.950			0.950				0.965				0.996
Satd. Flow (prot)	1770	5070	0	1770	5075	0	0	1753	0	0	1649	0
Fit Permitted	0.218			0.370				0.708				0.978
Satd. Flow (perm)	406	5070	0	689	5075	0	0	1286	0	0	1620	0
Right Turn on Red			Yes			Yes			Yes			Yes
Satd. Flow (RTOR)		5			3			6				87
Link Speed (mph)	42			42			30					30
Link Distance (ft)		1673			2404		392					423
Travel Time (s)		27.2			39.0		8.9					9.6
Peak Hour Factor	0.93	0.93	0.93	0.93	0.93	0.93	0.93	0.93	0.93	0.93	0.93	0.93
Adj. Flow (vph)	31	675	16	3	1139	18	23	3	6	9	10	87
Shared Lane Traffic (%)												
Lane Group Flow (vph)	31	691	0	3	1157	0	0	32	0	0	106	0
Enter Blocked Intersection	No	No	No	No	No	No	No	No	No	No	No	No
Lane Alignment	Left	Left	Right	Left	Left	Right	Left	Left	Right	Left	Left	Right
Median Width(ft)	12			12			0					0
Link Offset(ft)	0			0			0					0
Crosswalk Width(ft)	16			16			16					16
Two way Left Turn Lane												
Headway Factor	1.00	1.00	1.00	1.00	1.00	1.00	1.00	1.00	1.00	1.00	1.00	1.00
Turning Speed (mph)	15		9	15		9	15		9	15		9
Number of Detectors	1	1		1	1		1	1		1	1	1
Detector Template												
Leading Detector (ft)	50	50		50	50		50	50		50	50	
Trailing Detector (ft)	0	0		0	0		0	0		0	0	
Detector 1 Position(ft)	0	0		0	0		0	0		0	0	
Detector 1 Size(ft)	50	50		50	50		50	50		50	50	
Detector 1 Type	Cl+Ex	Cl+Ex		Cl+Ex	Cl+Ex		Cl+Ex	Cl+Ex		Cl+Ex	Cl+Ex	
Detector 1 Channel												
Detector 1 Extend (s)	0.0	0.0		0.0	0.0		0.0	0.0		0.0	0.0	
Detector 1 Queue (s)	0.0	0.0		0.0	0.0		0.0	0.0		0.0	0.0	
Detector 1 Delay (s)	0.0	0.0		0.0	0.0		0.0	0.0		0.0	0.0	
Turn Type	Perm	NA		Perm	NA		Perm	NA		Perm	NA	
Protected Phases		6 14			2 10			4 12			4 12	
Permitted Phases	6 14			2 10			4 12			4 12		
Detector Phase	6 14	6 14		2 10	2 10		4 12	4 12		4 12	4 12	
Switch Phase												
Minimum Initial (s)												
Minimum Split (s)												
Total Split (s)												

Pepper Square TIA  
Lanes, Volumes, Timings

Phase 1 - 2026 - Background - AM  
1335: Meadow Creek & Belt Line

Lane Group	Ø2	Ø4	Ø6	Ø10	Ø12	Ø14
Lane Configurations						
Traffic Volume (vph)						
Future Volume (vph)						
Ideal Flow (vphpl)						
Storage Length (ft)						
Storage Lanes						
Taper Length (ft)						
Lane Util. Factor						
Frt						
Fit Protected						
Satd. Flow (prot)						
Fit Permitted						
Satd. Flow (perm)						
Right Turn on Red						
Satd. Flow (RTOR)						
Link Speed (mph)						
Link Distance (ft)						
Travel Time (s)						
Peak Hour Factor						
Adj. Flow (vph)						
Shared Lane Traffic (%)						
Lane Group Flow (vph)						
Enter Blocked Intersection						
Lane Alignment						
Median Width(ft)						
Link Offset(ft)						
Crosswalk Width(ft)						
Two way Left Turn Lane						
Headway Factor						
Turning Speed (mph)						
Number of Detectors						
Detector Template						
Leading Detector (ft)						
Trailing Detector (ft)						
Detector 1 Position(ft)						
Detector 1 Size(ft)						
Detector 1 Type						
Detector 1 Channel						
Detector 1 Extend (s)						
Detector 1 Queue (s)						
Detector 1 Delay (s)						
Turn Type						
Protected Phases	2	4	6	10	12	14
Permitted Phases						
Detector Phase						
Switch Phase						
Minimum Initial (s)	12.0	6.0	12.0	12.0	12.0	6.0
Minimum Split (s)	17.0	23.5	17.0	20.0	23.0	20.0
Total Split (s)	96.0	22.0	96.0	22.0	20.0	22.0

Pepper Square TIA  
Lanes, Volumes, Timings

Phase 1 - 2026 - Background - AM  
1335: Meadow Creek & Belt Line

Lane Group	EBL	EBT	EBR	WBL	WBT	WBR	NBL	NBT	NBR	SBL	SBT	SBR
Total Split (%)												
Maximum Green (s)												
Yellow Time (s)												
All-Red Time (s)												
Lost Time Adjust (s)												
Total Lost Time (s)												
Lead/Lag												
Lead-Lag Optimize?												
Vehicle Extension (s)												
Recall Mode												
Walk Time (s)												
Flash Dont Walk (s)												
Pedestrian Calls (#/hr)												
Act Effect Green (s)	122.1	122.1		122.1	122.1			21.9				21.9
Actuated g/C Ratio	0.76	0.76		0.76	0.76			0.14				0.14
v/c Ratio	0.10	0.18		0.01	0.30			0.18				0.36
Control Delay	1.9	1.2		0.3	0.3			40.0				15.5
Queue Delay	0.0	0.0		0.0	0.0			0.0				0.0
Total Delay	1.9	1.2		0.3	0.3			40.0				15.5
LOS	A	A		A	A			D				B
Approach Delay		1.3			0.3			40.0				15.5
Approach LOS		A			A			D				B
Queue Length 50th (ft)	1	10		0	5			21				15
Queue Length 95th (ft)	3	12		m0	m5			48				62
Internal Link Dist (ft)		1593			2324			312				343
Turn Bay Length (ft)	150			150								
Base Capacity (vph)	321	4018		545	4021			278				412
Starvation Cap Reductn	0	0		0	0			0				0
Spillback Cap Reductn	0	0		0	0			0				0
Storage Cap Reductn	0	0		0	0			0				0
Reduced v/c Ratio	0.10	0.17		0.01	0.29			0.12				0.26

**Intersection Summary**  
 Area Type: Other  
 Cycle Length: 160  
 Actuated Cycle Length: 160  
 Offset: 82 (51%), Referenced to phase 2:WBTl and 6:EBTL, Start of Yellow  
 Natural Cycle: 85  
 Control Type: Actuated-Coordinated  
 Maximum v/c Ratio: 0.36  
 Intersection Signal Delay: 2.1 Intersection LOS: A  
 Intersection Capacity Utilization 39.1% ICU Level of Service A  
 Analysis Period (min) 15  
 m Volume for 95th percentile queue is metered by upstream signal.

Splits and Phases: 1335: Meadow Creek & Belt Line



Pepper Square TIA  
Lanes, Volumes, Timings

Phase 1 - 2026 - Background - AM  
1335: Meadow Creek & Belt Line

Lane Group	Ø2	Ø4	Ø6	Ø10	Ø12	Ø14
Total Split (%)	60%	14%	60%	14%	13%	14%
Maximum Green (s)	91.0	16.5	91.0	17.0	15.0	16.5
Yellow Time (s)	4.0	3.7	4.0	4.0	4.0	3.7
All-Red Time (s)	1.0	1.8	1.0	1.0	1.0	1.8
Lost Time Adjust (s)						
Total Lost Time (s)						
Lead/Lag						
Lead-Lag Optimize?						
Vehicle Extension (s)	2.0	1.8	2.0	2.0	1.8	2.0
Recall Mode	C-Max	None	C-Min	None	None	None
Walk Time (s)	4.0	4.0	4.0	4.0	4.0	4.0
Flash Dont Walk (s)	8.0	14.0	8.0	8.0	14.0	8.0
Pedestrian Calls (#/hr)	0	0	0	0	0	0
Act Effect Green (s)						
Actuated g/C Ratio						
v/c Ratio						
Control Delay						
Queue Delay						
Total Delay						
LOS						
Approach Delay						
Approach LOS						
Queue Length 50th (ft)						
Queue Length 95th (ft)						
Internal Link Dist (ft)						
Turn Bay Length (ft)						
Base Capacity (vph)						
Starvation Cap Reductn						
Spillback Cap Reductn						
Storage Cap Reductn						
Reduced v/c Ratio						

Intersection Summary

Pepper Square TIA  
Lanes, Volumes, Timings

Phase 1 - 2026 - Background - AM  
1365: Preston & Arapahoe



Lane Group	EBU	EBL	EBT	EBR	WBL	WBT	WBR	NBU	NBL	NBT	NBR	SBU
Lane Configurations		↔	↔		↔	↔			↔	↔		
Traffic Volume (vph)	3	134	261	142	117	731	168	1	118	1677	89	4
Future Volume (vph)	3	134	261	142	117	731	168	1	118	1677	89	4
Ideal Flow (vphpl)	1900	1900	1900	1900	1900	1900	1900	1900	1900	1900	1900	1900
Storage Length (ft)		150		0	150		0		300		0	
Storage Lanes		2		0	2		0		2		0	
Taper Length (ft)		25			25				25			
Lane Util. Factor	0.91	0.97	0.91	0.91	0.97	0.91	0.91	0.91	0.97	0.91	0.91	0.91
Frt			0.947			0.972					0.992	
Fit Protected		0.950			0.950				0.950			
Satd. Flow (prot)	0	3433	4816	0	3433	4943	0	0	3433	5045	0	0
Fit Permitted		0.950			0.950				0.950			
Satd. Flow (perm)	0	3433	4816	0	3433	4943	0	0	3433	5045	0	0
Right Turn on Red			Yes			Yes				Yes		
Satd. Flow (RTOR)			81			33				7		
Link Speed (mph)		42			42				42			
Link Distance (ft)		1672			1942				3054			
Travel Time (s)		27.1			31.5				49.6			
Peak Hour Factor	0.95	0.95	0.95	0.95	0.95	0.95	0.95	0.95	0.95	0.95	0.95	0.95
Adj. Flow (vph)	3	141	275	149	123	769	177	1	124	1765	94	4
Shared Lane Traffic (%)												
Lane Group Flow (vph)	0	144	424	0	123	946	0	0	125	1859	0	0
Enter Blocked Intersection	No	No	No	No	No	No	No	No	No	No	No	No
Lane Alignment	R NA	Left	Left	Right	Left	Left	Right	R NA	Left	Left	Right	R NA
Median Width(ft)		24			24				24			
Link Offset(ft)		0			0				0			
Crosswalk Width(ft)			16			16					16	
Two way Left Turn Lane												
Headway Factor	1.00	1.00	1.00	1.00	1.00	1.00	1.00	1.00	1.00	1.00	1.00	1.00
Turning Speed (mph)	9	15		9	15		9	9	15		9	9
Number of Detectors	1	1	1		1	1		1	1	1		1
Detector Template												
Leading Detector (ft)	50	50	50		50	50		50	50	50		50
Trailing Detector (ft)	0	0	0		0	0		0	0	0		0
Detector 1 Position(ft)	0	0	0		0	0		0	0	0		0
Detector 1 Size(ft)	50	50	50		50	50		50	50	50		50
Detector 1 Type	CI+Ex	CI+Ex	CI+Ex		CI+Ex	CI+Ex		CI+Ex	CI+Ex	CI+Ex		CI+Ex
Detector 1 Channel												
Detector 1 Extend (s)	0.0	0.0	0.0		0.0	0.0		0.0	0.0	0.0		0.0
Detector 1 Queue (s)	0.0	0.0	0.0		0.0	0.0		0.0	0.0	0.0		0.0
Detector 1 Delay (s)	0.0	0.0	0.0		0.0	0.0		0.0	0.0	0.0		0.0
Turn Type	Prot	Prot	NA		Prot	NA		Prot	Prot	NA		Prot
Protected Phases	3	3	8		7	4		1	1	6		5
Permitted Phases												
Detector Phase	3	3	8		7	4		1	1	6		5
Switch Phase												
Minimum Initial (s)	3.0	3.0	18.0		3.0	18.0		3.0	3.0	18.0		3.0
Minimum Split (s)	10.0	10.0	36.7		21.0	36.3		10.0	10.0	35.7		10.0
Total Split (s)	13.0	13.0	44.0		18.0	49.0		14.0	14.0	78.0		20.0



Pepper Square TIA  
Lanes, Volumes, Timings

Phase 1 - 2026 - Background - AM  
1365: Preston & Arapaho

Lane Group	SBL	SBT	SBR
Lane Configurations	↑↑	↑↑↑	
Traffic Volume (vph)	100	1818	216
Future Volume (vph)	100	1818	216
Ideal Flow (vphpl)	1900	1900	1900
Storage Length (ft)	250		0
Storage Lanes	2		0
Taper Length (ft)	25		
Lane Util. Factor	0.97	0.91	0.91
Frt		0.984	
Fit Protected	0.950		
Satd. Flow (prot)	3433	5004	0
Fit Permitted	0.950		
Satd. Flow (perm)	3433	5004	0
Right Turn on Red			Yes
Satd. Flow (RTOR)		18	
Link Speed (mph)		48	
Link Distance (ft)		5087	
Travel Time (s)		72.3	
Peak Hour Factor	0.95	0.95	0.95
Adj. Flow (vph)	105	1914	227
Shared Lane Traffic (%)			
Lane Group Flow (vph)	109	2141	0
Enter Blocked Intersection	No	No	No
Lane Alignment	Left	Left	Right
Median Width(ft)		24	
Link Offset(ft)		0	
Crosswalk Width(ft)		16	
Two way Left Turn Lane			
Headway Factor	1.00	1.00	1.00
Turning Speed (mph)	15		9
Number of Detectors	1	1	
Detector Template			
Leading Detector (ft)	50	50	
Trailing Detector (ft)	0	0	
Detector 1 Position(ft)	0	0	
Detector 1 Size(ft)	50	50	
Detector 1 Type	CI+Ex	CI+Ex	
Detector 1 Channel			
Detector 1 Extend (s)	0.0	0.0	
Detector 1 Queue (s)	0.0	0.0	
Detector 1 Delay (s)	0.0	0.0	
Turn Type	Prot	NA	
Protected Phases	5	2	
Permitted Phases			
Detector Phase	5	2	
Switch Phase			
Minimum Initial (s)	3.0	18.0	
Minimum Split (s)	10.0	37.7	
Total Split (s)	20.0	84.0	

09/22/2022 10:16 am  
Kimley-Horn

Synchro 11 Report  
Page 9

Pepper Square TIA  
Lanes, Volumes, Timings

Phase 1 - 2026 - Background - AM  
1365: Preston & Arapaho

Lane Group	EBU	EBL	EBT	EBR	WBL	WBT	WBR	NBU	NBL	NBT	NBR	SBU
Total Split (%)	8.1%	8.1%	27.5%		11.3%	30.6%		8.8%	8.8%	48.8%		12.5%
Maximum Green (s)	7.5	7.5	38.7		12.5	43.7		8.5	8.5	72.3		14.5
Yellow Time (s)	3.0	3.0	4.3		3.0	4.3		3.0	3.0	4.7		3.0
All-Red Time (s)	2.5	2.5	1.0		2.5	1.0		2.5	2.5	1.0		2.5
Lost Time Adjust (s)		-1.0	-1.4		-1.0	-1.0			-1.0	-1.7		
Total Lost Time (s)		4.5	3.9		4.5	4.3			4.5	4.0		
Lead/Lag	Lead	Lead	Lag		Lead	Lag		Lead	Lead	Lead		Lag
Lead-Lag Optimize?	Yes	Yes	Yes		Yes	Yes		Yes	Yes	Yes		Yes
Vehicle Extension (s)	0.8	0.8	2.5		0.8	1.8		1.5	1.5	1.7		1.5
Recall Mode	None	None	Max		None	None		None	None	Max		None
Walk Time (s)			4.0			4.0				4.0		
Flash Dont Walk (s)			27.0			27.0				26.0		
Pedestrian Calls (#/hr)			0			0				0		
Act Effect Green (s)		8.4	43.6		10.0	44.8			9.1	74.0		
Actuated g/C Ratio		0.05	0.27		0.06	0.28			0.06	0.46		
v/c Ratio		0.80	0.31		0.57	0.67			0.64	0.80		
Control Delay		102.0	37.3		78.6	61.9			83.5	24.6		
Queue Delay		0.0	0.0		0.0	0.0			0.0	0.0		
Total Delay		102.0	37.3		78.6	61.9			83.5	24.6		
LOS		F	D		E	E			F	C		
Approach Delay			53.7			63.8				28.4		
Approach LOS			D			E				C		
Queue Length 50th (ft)		78	104		65	352			59	663		
Queue Length 95th (ft)		#140	139		101	414			m89	736		
Internal Link Dist (ft)			1592			1862				2974		
Turn Bay Length (ft)		150			150				300			
Base Capacity (vph)		182	1371		289	1407			203	2337		
Starvation Cap Reductn		0	0		0	0			0	0		
Spillback Cap Reductn		0	0		0	0			0	0		
Storage Cap Reductn		0	0		0	0			0	0		
Reduced v/c Ratio		0.79	0.31		0.43	0.67			0.62	0.80		

Intersection Summary

Area Type: Other  
 Cycle Length: 160  
 Actuated Cycle Length: 160  
 Offset: 11 (7%), Referenced to phase 2:SBT, Start of Yellow  
 Natural Cycle: 120  
 Control Type: Actuated-Coordinated  
 Maximum v/c Ratio: 0.85  
 Intersection Signal Delay: 44.4  
 Intersection LOS: D  
 Intersection Capacity Utilization 79.5%  
 ICU Level of Service D  
 Analysis Period (min) 15  
 # 95th percentile volume exceeds capacity, queue may be longer.  
 Queue shown is maximum after two cycles.  
 m Volume for 95th percentile queue is metered by upstream signal.

Splits and Phases: 1365: Preston & Arapaho

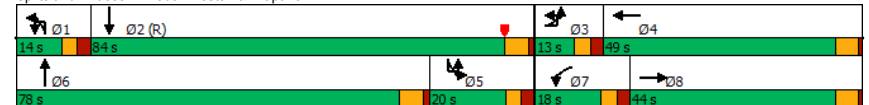

Pepper Square TIA  
Lanes, Volumes, Timings

Phase 1 - 2026 - Background - AM  
1365: Preston & Arapaho

Lane Group	SBL	SBT	SBR
Total Split (%)	12.5%	52.5%	
Maximum Green (s)	14.5	78.3	
Yellow Time (s)	3.0	4.7	
All-Red Time (s)	2.5	1.0	
Lost Time Adjust (s)	-1.0	-1.7	
Total Lost Time (s)	4.5	4.0	
Lead/Lag	Lag	Lag	
Lead-Lag Optimize?	Yes	Yes	
Vehicle Extension (s)	1.5	1.5	
Recall Mode	None	C-Max	
Walk Time (s)		4.0	
Flash Dont Walk (s)		28.0	
Pedestrian Calls (#/hr)		0	
Act Effect Green (s)	15.5	80.4	
Actuated g/C Ratio	0.10	0.50	
v/c Ratio	0.33	0.85	
Control Delay	79.2	45.4	
Queue Delay	0.0	0.0	
Total Delay	79.2	45.4	
LOS	E	D	
Approach Delay		47.1	
Approach LOS		D	
Queue Length 50th (ft)	55	755	
Queue Length 95th (ft)	m69	846	
Internal Link Dist (ft)		5007	
Turn Bay Length (ft)	250		
Base Capacity (vph)	332	2523	
Starvation Cap Reductn	0	0	
Spillback Cap Reductn	0	0	
Storage Cap Reductn	0	0	
Reduced v/c Ratio	0.33	0.85	

Intersection Summary

Pepper Square TIA  
Lanes, Volumes, Timings

Phase 1 - 2026 - Background - AM  
1367: Preston & Belt Line

Lane Group	EBU	EBL	EBT	EBR	WBL	WBT	WBR	NBL	NBT	NBR	SBU	SBL
Lane Configurations		↔	↔	↔	↔	↔	↔	↔	↔	↔	↔	↔
Traffic Volume (vph)	10	148	391	212	68	834	119	249	1570	22	2	128
Future Volume (vph)	10	148	391	212	68	834	119	249	1570	22	2	128
Ideal Flow (vphpl)	1900	1900	1900	1900	1900	1900	1900	1900	1900	1900	1900	1900
Storage Length (ft)		150		150	200		0	250		0		200
Storage Lanes		2		1	1		0	2		0		1
Taper Length (ft)		25			25			25				25
Lane Util. Factor	0.91	0.97	0.91	1.00	1.00	0.91	0.91	0.97	0.91	0.91	0.91	1.00
Fit			0.850		0.981			0.998				
Fit Protected		0.950		0.950		0.950		0.950				0.950
Satd. Flow (prot)	0	3433	5085	1583	1770	4989	0	3433	5075	0	0	1770
Fit Permitted		0.950		0.950		0.950		0.950				0.950
Satd. Flow (perm)	0	3433	5085	1583	1770	4989	0	3433	5075	0	0	1770
Right Turn on Red				Yes		Yes			Yes			
Satd. Flow (RTOR)				206		16			2			
Link Speed (mph)			42			42			42			
Link Distance (ft)			925			394			261			
Travel Time (s)			15.0			6.4			4.2			
Peak Hour Factor	0.95	0.95	0.95	0.95	0.95	0.95	0.95	0.95	0.95	0.95	0.95	0.95
Adj. Flow (vph)	11	156	412	223	72	878	125	262	1653	23	2	135
Shared Lane Traffic (%)												
Lane Group Flow (vph)	0	167	412	223	72	1003	0	262	1676	0	0	137
Enter Blocked Intersection	No	No	No	No	No	No	No	No	No	No	No	No
Lane Alignment	R NA	Left	Left	Right	Left	Left	Right	Left	Left	Right	R NA	Left
Median Width(ft)			24			24			24			
Link Offset(ft)			0			0			0			
Crosswalk Width(ft)				16		16			16			
Two way Left Turn Lane												
Headway Factor	1.00	1.00	1.00	1.00	1.00	1.00	1.00	1.00	1.00	1.00	1.00	1.00
Turning Speed (mph)	9	15		9	15		9	15		9	9	15
Number of Detectors	1	1	1	1	1	1	1	1	1	1	1	1
Detector Template												
Leading Detector (ft)	50	50	50	50	50	50		50	50		50	50
Trailing Detector (ft)	0	0	0	0	0	0		0	0		0	0
Detector 1 Position(ft)	0	0	0	0	0	0		0	0		0	0
Detector 1 Size(ft)	50	50	50	50	50	50		50	50		50	50
Detector 1 Type	CI+Ex	CI+Ex	CI+Ex	CI+Ex	CI+Ex	CI+Ex		CI+Ex	CI+Ex		CI+Ex	CI+Ex
Detector 1 Channel												
Detector 1 Extend (s)	0.0	0.0	0.0	0.0	0.0	0.0		0.0	0.0		0.0	0.0
Detector 1 Queue (s)	0.0	0.0	0.0	0.0	0.0	0.0		0.0	0.0		0.0	0.0
Detector 1 Delay (s)	0.0	0.0	0.0	0.0	0.0	0.0		0.0	0.0		0.0	0.0
Turn Type	Prot	Prot	NA	Perm	Prot	NA		Prot	NA		Prot	Prot
Protected Phases	3	3	8		7	4		1	6		5	5
Permitted Phases				8								
Detector Phase	3	3	8	8	7	4		1	6		5	5
Switch Phase												
Minimum Initial (s)	3.0	3.0	18.0	18.0	3.0	18.0		3.0	18.0		3.0	3.0
Minimum Split (s)	11.0	11.0	32.5	32.5	8.0	32.5		8.0	33.0		11.0	11.0
Total Split (s)	16.0	16.0	42.0	42.0	20.0	46.0		18.0	76.0		22.0	22.0

Pepper Square TIA  
Lanes, Volumes, Timings

Phase 1 - 2026 - Background - AM  
1367: Preston & Belt Line

Lane Group	SBT	SBR
Lane Configurations	↑↑↑	↑
Traffic Volume (vph)	1749	241
Future Volume (vph)	1749	241
Ideal Flow (vphpl)	1900	1900
Storage Length (ft)	300	
Storage Lanes	1	
Taper Length (ft)		
Lane Util. Factor	0.91	1.00
Frt	0.850	
Fit Protected		
Satd. Flow (prot)	5085	1583
Fit Permitted		
Satd. Flow (perm)	5085	1583
Right Turn on Red	Yes	
Satd. Flow (RTOR)	182	
Link Speed (mph)	40	
Link Distance (ft)	3054	
Travel Time (s)	52.1	
Peak Hour Factor	0.95	0.95
Adj. Flow (vph)	1841	254
Shared Lane Traffic (%)		
Lane Group Flow (vph)	1841	254
Enter Blocked Intersection	No	No
Lane Alignment	Left	Right
Median Width(ft)	24	
Link Offset(ft)	0	
Crosswalk Width(ft)	16	
Two way Left Turn Lane		
Headway Factor	1.00	1.00
Turning Speed (mph)	9	
Number of Detectors	1	1
Detector Template		
Leading Detector (ft)	50	50
Trailing Detector (ft)	0	0
Detector 1 Position(ft)	0	0
Detector 1 Size(ft)	50	50
Detector 1 Type	CI+Ex	CI+Ex
Detector 1 Channel		
Detector 1 Extend (s)	0.0	0.0
Detector 1 Queue (s)	0.0	0.0
Detector 1 Delay (s)	0.0	0.0
Turn Type	NA	Perm
Protected Phases	2	
Permitted Phases	2	
Detector Phase	2	2
Switch Phase		
Minimum Initial (s)	18.0	18.0
Minimum Split (s)	33.0	33.0
Total Split (s)	80.0	80.0

09/22/2022 10:16 am  
Kimley-Horn

Synchro 11 Report  
Page 13

Pepper Square TIA  
Lanes, Volumes, Timings

Phase 1 - 2026 - Background - AM  
1367: Preston & Belt Line

Lane Group	EBU	EBL	EBT	EBR	WBL	WBT	WBR	NBL	NBT	NBR	SBU	SBL
Total Split (%)	10.0%	10.0%	26.3%	26.3%	12.5%	28.8%		11.3%	47.5%		13.8%	13.8%
Maximum Green (s)	11.0	11.0	36.5	36.5	15.0	40.5		13.0	70.0		17.0	17.0
Yellow Time (s)	3.0	3.0	4.0	4.0	3.0	4.0		3.0	4.4		3.0	3.0
All-Red Time (s)	2.0	2.0	1.5	1.5	2.0	1.5		2.0	1.6		2.0	2.0
Lost Time Adjust (s)		-1.0	-1.5	-1.5	-1.0	-1.5		-1.0	-1.7			-1.0
Total Lost Time (s)		4.0	4.0	4.0	4.0	4.0		4.0	4.3			4.0
Lead/Lag	Lead	Lead	Lead	Lead	Lag	Lag		Lag	Lag		Lead	Lead
Lead-Lag Optimize?	Yes	Yes	Yes	Yes	Yes	Yes		Yes	Yes		Yes	Yes
Vehicle Extension (s)	1.3	1.3	1.3	1.3	1.0	1.3		1.6	2.0		1.5	1.5
Recall Mode	None	None	Max	Max	None	Max		None	C-Max		None	None
Walk Time (s)			7.0	7.0		7.0			7.0			
Flash Dont Walk (s)			20.0	20.0		20.0			20.0			
Pedestrian Calls (#/hr)			0	0		0			0			
Act Effect Green (s)		11.2	38.0	38.0	16.0	42.8		14.0	73.8			15.9
Actuated g/C Ratio		0.07	0.24	0.24	0.10	0.27		0.09	0.46			0.10
v/c Ratio		0.70	0.34	0.42	0.41	0.74		0.87	0.72			0.78
Control Delay		74.2	41.2	9.6	45.8	27.3		87.7	25.9			104.0
Queue Delay		0.0	0.0	0.0	0.0	0.0		0.0	0.7			0.0
Total Delay		74.2	41.2	9.6	45.8	27.3		87.7	26.7			104.0
LOS		E	D	A	D	C		F	C			F
Approach Delay			39.3			28.5			34.9			
Approach LOS			D			C			C			
Queue Length 50th (ft)		90	138	78	69	296		147	480			127
Queue Length 95th (ft)		131	176	132	131	388		#229	710			m163
Internal Link Dist (ft)			845			314			181			
Turn Bay Length (ft)		150		150	200			250				200
Base Capacity (vph)		257	1207	533	177	1347		300	2343			199
Starvation Cap Reductn		0	0	0	0	0		0	331			0
Spillback Cap Reductn		0	0	0	0	0		0	0			0
Storage Cap Reductn		0	0	0	0	0		0	0			0
Reduced v/c Ratio		0.65	0.34	0.42	0.41	0.74		0.87	0.83			0.69

Intersection Summary

Area Type: Other  
 Cycle Length: 160  
 Actuated Cycle Length: 160  
 Offset: 81 (51%), Referenced to phase 6:NBT, Start of Yellow  
 Natural Cycle: 90  
 Control Type: Actuated-Coordinated  
 Maximum v/c Ratio: 0.87  
 Intersection Signal Delay: 28.0  
 Intersection LOS: C  
 Intersection Capacity Utilization 77.8%  
 ICU Level of Service D  
 Analysis Period (min) 15  
 # 95th percentile volume exceeds capacity, queue may be longer.  
 Queue shown is maximum after two cycles.  
 m Volume for 95th percentile queue is metered by upstream signal.

Splits and Phases: 1367: Preston & Belt Line

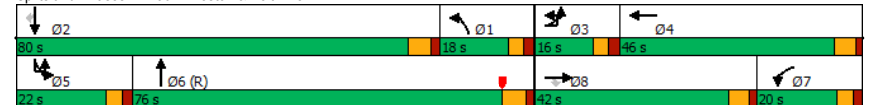

Pepper Square TIA  
Lanes, Volumes, Timings

Phase 1 - 2026 - Background - AM  
1367: Preston & Belt Line

Lane Group	SBT	SBR
Total Split (%)	50.0%	50.0%
Maximum Green (s)	74.0	74.0
Yellow Time (s)	4.4	4.4
All-Red Time (s)	1.6	1.6
Lost Time Adjust (s)	-1.7	-1.7
Total Lost Time (s)	4.3	4.3
Lead/Lag	Lead	Lead
Lead-Lag Optimize?	Yes	Yes
Vehicle Extension (s)	2.5	2.5
Recall Mode	Max	Max
Walk Time (s)	7.0	7.0
Flash Dont Walk (s)	20.0	20.0
Pedestrian Calls (#/hr)	0	0
Act Effect Green (s)	75.7	75.7
Actuated g/C Ratio	0.47	0.47
v/c Ratio	0.77	0.30
Control Delay	13.7	0.9
Queue Delay	0.0	0.0
Total Delay	13.7	0.9
LOS	B	A
Approach Delay	17.8	
Approach LOS	B	
Queue Length 50th (ft)	309	0
Queue Length 95th (ft)	289	m3
Internal Link Dist (ft)	2974	
Turn Bay Length (ft)		300
Base Capacity (vph)	2405	844
Starvation Cap Reductn	0	0
Spillback Cap Reductn	0	0
Storage Cap Reductn	0	0
Reduced v/c Ratio	0.77	0.30

Intersection Summary

Pepper Square TIA  
Lanes, Volumes, Timings

Phase 1 - 2026 - Background - AM  
1368: Preston & Alexis

Lane Group	EBL	EBT	EBR	WBL	WBT	WBR	NBU	NBL	NBT	NBR	SBL	SBT
Lane Configurations	↔	↔	↔	↔	↔	↔	↔	↔	↔	↔	↔	↔
Traffic Volume (vph)	15	5	28	163	22	59	3	21	1832	92	82	1904
Future Volume (vph)	15	5	28	163	22	59	3	21	1832	92	82	1904
Ideal Flow (vphpl)	1900	1900	1900	1900	1900	1900	1900	1900	1900	1900	1900	1900
Storage Length (ft)	0		0	175		0		150		150	150	
Storage Lanes	1		1	2		1		1		1	1	
Taper Length (ft)	25			25				25			25	
Lane Util. Factor	0.91	0.91	1.00	0.97	1.00	1.00	0.91	1.00	0.91	1.00	1.00	0.91
Fit			0.850			0.850				0.850		
Fit Protected	0.950	0.970		0.950				0.950			0.950	
Satd. Flow (prot)	1610	3288	1583	3433	1863	1583	0	1770	5085	1583	1770	5085
Fit Permitted	0.950	0.970		0.950				0.070			0.071	
Satd. Flow (perm)	1610	3288	1583	3433	1863	1583	0	130	5085	1583	132	5085
Right Turn on Red			Yes			Yes				Yes		
Satd. Flow (RTOR)			125			85				89		
Link Speed (mph)		30			30			43				42
Link Distance (ft)		660			627			2867				173
Travel Time (s)		15.0			14.3			45.5				2.8
Peak Hour Factor	0.92	0.92	0.92	0.92	0.92	0.92	0.92	0.92	0.92	0.92	0.92	0.92
Adj. Flow (vph)	16	5	30	177	24	64	3	23	1991	100	89	2070
Shared Lane Traffic (%)	50%											
Lane Group Flow (vph)	8	13	30	177	24	64	0	26	1991	100	89	2070
Enter Blocked Intersection	No	No	No	No	No	No	No	No	No	No	No	No
Lane Alignment	Left	Left	Right	Left	Left	Right	R NA	Left	Left	Right	Left	Left
Median Width(ft)		24			24			12				12
Link Offset(ft)		0			0			0				0
Crosswalk Width(ft)		16			16			16				16
Two way Left Turn Lane												
Headway Factor	1.00	1.00	1.00	1.00	1.00	1.00	1.00	1.00	1.00	1.00	1.00	1.00
Turning Speed (mph)	15		9	15		9	9	15		9	15	
Number of Detectors	1	1	1	1	1	1	1	1	1	1	1	1
Detector Template												
Leading Detector (ft)	50	50	50	50	50	50	50	50	50	50	50	50
Trailing Detector (ft)	0	0	0	0	0	0	0	0	0	0	0	0
Detector 1 Position(ft)	0	0	0	0	0	0	0	0	0	0	0	0
Detector 1 Size(ft)	50	50	50	50	50	50	50	50	50	50	50	50
Detector 1 Type	CI+Ex	CI+Ex	CI+Ex	CI+Ex	CI+Ex	CI+Ex	CI+Ex	CI+Ex	CI+Ex	CI+Ex	CI+Ex	CI+Ex
Detector 1 Channel												
Detector 1 Extend (s)	0.0	0.0	0.0	0.0	0.0	0.0	0.0	0.0	0.0	0.0	0.0	0.0
Detector 1 Queue (s)	0.0	0.0	0.0	0.0	0.0	0.0	0.0	0.0	0.0	0.0	0.0	0.0
Detector 1 Delay (s)	0.0	0.0	0.0	0.0	0.0	0.0	0.0	0.0	0.0	0.0	0.0	0.0
Turn Type	Split	NA	Perm	Split	NA	pm+ov	custom	D,P+P	NA	Perm	D,P+P	NA
Protected Phases	3	3		4	4	5		1	6		5	2
Permitted Phases			3			4	1	2		6		6
Detector Phase	3	3	3	4	4	5	1	1	6	6	5	2
Switch Phase												
Minimum Initial (s)	6.0	6.0	6.0	8.0	8.0	3.0	3.0	3.0	14.0	14.0	3.0	14.0
Minimum Split (s)	27.0	27.0	27.0	27.0	27.0	8.4	8.4	8.4	24.0	24.0	8.4	24.0
Total Split (s)	13.0	13.0	13.0	29.0	29.0	15.0	18.0	18.0	103.0	103.0	15.0	100.0

Pepper Square TIA  
Lanes, Volumes, Timings

Phase 1 - 2026 - Background - AM  
1368: Preston & Alexis

Lane Group	SBR
Left Configurations	↑
Traffic Volume (vph)	23
Future Volume (vph)	23
Ideal Flow (vphpl)	1900
Storage Length (ft)	150
Storage Lanes	1
Taper Length (ft)	
Lane Util. Factor	1.00
Frt	0.850
Fit Protected	
Satd. Flow (prot)	1583
Fit Permitted	
Satd. Flow (perm)	1583
Right Turn on Red	Yes
Satd. Flow (RTOR)	78
Link Speed (mph)	
Link Distance (ft)	
Travel Time (s)	
Peak Hour Factor	0.92
Adj. Flow (vph)	25
Shared Lane Traffic (%)	
Lane Group Flow (vph)	25
Enter Blocked Intersection	No
Lane Alignment	Right
Median Width(ft)	
Link Offset(ft)	
Crosswalk Width(ft)	
Two way Left Turn Lane	
Headway Factor	1.00
Turning Speed (mph)	9
Number of Detectors	1
Detector Template	
Leading Detector (ft)	50
Trailing Detector (ft)	0
Detector 1 Position(ft)	0
Detector 1 Size(ft)	50
Detector 1 Type	CI+Ex
Detector 1 Channel	
Detector 1 Extend (s)	0.0
Detector 1 Queue (s)	0.0
Detector 1 Delay (s)	0.0
Turn Type	Perm
Protected Phases	
Permitted Phases	2
Detector Phase	2
Switch Phase	
Minimum Initial (s)	14.0
Minimum Split (s)	24.0
Total Split (s)	100.0

Pepper Square TIA  
Lanes, Volumes, Timings

Phase 1 - 2026 - Background - AM  
1368: Preston & Alexis

Lane Group	EBL	EBT	EBR	WBL	WBT	WBR	NBU	NBL	NBT	NBR	SBL	SBT
Total Split (%)	8.1%	8.1%	8.1%	18.1%	18.1%	9.4%	11.3%	11.3%	64.4%	64.4%	9.4%	62.5%
Maximum Green (s)	8.0	8.0	8.0	24.0	24.0	10.6	13.6	13.6	97.0	97.0	10.6	94.0
Yellow Time (s)	4.0	4.0	4.0	4.0	4.0	3.4	3.4	3.4	4.5	4.5	3.4	4.5
All-Red Time (s)	1.0	1.0	1.0	1.0	1.0	1.0	1.0	1.0	1.5	1.5	1.0	1.5
Lost Time Adjust (s)	-1.0	-1.0	0.0	-1.0	-1.0	0.0			-1.0	-2.0	0.0	-1.0
Total Lost Time (s)	4.0	4.0	5.0	4.0	4.0	4.4			3.4	4.0	6.0	3.4
Lead/Lag	Lead	Lead	Lead	Lag	Lag	Lag	Lead	Lead	Lead	Lead	Lag	Lag
Lead-Lag Optimize?	Yes	Yes	Yes	Yes	Yes	Yes	Yes	Yes	Yes	Yes	Yes	Yes
Vehicle Extension (s)	2.0	2.0	2.0	2.0	2.0	1.2	1.2	1.2	2.5	2.5	1.2	2.5
Recall Mode	None	None	None	None	None	None	None	None	Max	Max	None	C-Max
Walk Time (s)	4.0	4.0	4.0	4.0	4.0				4.0	4.0		4.0
Flash Dont Walk (s)	18.0	18.0	18.0	18.0	18.0				14.0	14.0		14.0
Pedestrian Calls (#/hr)	0	0	0	0	0				0	0		0
Act Effect Green (s)	7.2	7.2	6.2	13.6	13.6	24.7		127.9	114.4	112.4	126.6	124.1
Actuated g/C Ratio	0.04	0.04	0.04	0.08	0.08	0.15		0.80	0.72	0.70	0.79	0.78
v/c Ratio	0.11	0.09	0.17	0.61	0.15	0.20		0.17	0.55	0.09	0.40	0.53
Control Delay	76.7	74.5	2.0	79.2	68.6	5.3		4.2	5.5	0.2	15.0	1.1
Queue Delay	0.0	0.0	0.0	0.0	0.0	0.0		0.0	0.0	0.0	0.0	0.0
Total Delay	76.7	74.5	2.0	79.2	68.6	5.3		4.2	5.5	0.2	15.0	1.2
LOS	E	E	A	E	E	A		A	A	A	B	A
Approach Delay		32.2			60.4				5.3			1.7
Approach LOS		C			E				A			A
Queue Length 50th (ft)	8	7	0	93	24	0		2	190	1	20	23
Queue Length 95th (ft)	30	20	0	133	55	22		6	205	0	66	28
Internal Link Dist (ft)		580			547				2787			93
Turn Bay Length (ft)				175				150		150	150	
Base Capacity (vph)	90	184	197	536	291	316		255	3635	1138	223	3942
Starvation Cap Reductn	0	0	0	0	0	0		0	0	0	0	216
Spillback Cap Reductn	0	0	0	0	0	0		0	0	0	0	0
Storage Cap Reductn	0	0	0	0	0	0		0	0	0	0	0
Reduced v/c Ratio	0.09	0.07	0.15	0.33	0.08	0.20		0.10	0.55	0.09	0.40	0.56

Intersection Summary

Area Type: Other  
 Cycle Length: 160  
 Actuated Cycle Length: 160  
 Offset: 89 (56%), Referenced to phase 2:NBSB, Start of Yellow  
 Natural Cycle: 110  
 Control Type: Actuated-Coordinated  
 Maximum v/c Ratio: 0.61  
 Intersection Signal Delay: 7.0  
 Intersection LOS: A  
 Intersection Capacity Utilization 66.0%  
 ICU Level of Service C  
 Analysis Period (min) 15  
 m Volume for 95th percentile queue is metered by upstream signal.

Splits and Phases: 1368: Preston & Alexis

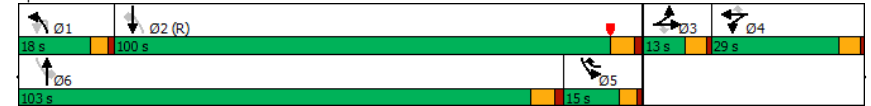

Pepper Square TIA  
Lanes, Volumes, Timings

Phase 1 - 2026 - Background - AM  
1368: Preston & Alexis

Lane Group	SBR
Total Split (%)	62.5%
Maximum Green (s)	94.0
Yellow Time (s)	4.5
All-Red Time (s)	1.5
Lost Time Adjust (s)	0.0
Total Lost Time (s)	6.0
Lead/Lag	Lag
Lead-Lag Optimize?	Yes
Vehicle Extension (s)	2.5
Recall Mode	C-Max
Walk Time (s)	4.0
Flash Dont Walk (s)	14.0
Pedestrian Calls (#/hr)	0
Act Effect Green (s)	122.1
Actuated g/C Ratio	0.76
v/c Ratio	0.02
Control Delay	0.0
Queue Delay	0.0
Total Delay	0.0
LOS	A
Approach Delay	
Approach LOS	
Queue Length 50th (ft)	0
Queue Length 95th (ft)	m0
Internal Link Dist (ft)	
Turn Bay Length (ft)	150
Base Capacity (vph)	1225
Starvation Cap Reductn	0
Spillback Cap Reductn	0
Storage Cap Reductn	0
Reduced v/c Ratio	0.02

Intersection Summary

Pepper Square TIA  
Lanes, Volumes, Timings

Phase 1 - 2026 - Background - AM  
1369: Preston & Belt Line Village Driveway

Lane Group	EBL	EBT	EBR	WBL	WBT	WBR	NBL	NBT	NBR	SBU	SBL	SBT
Lane Configurations		↕↕			↕↕		↕↕	↕↕↕			↕↕	↕↕↕
Traffic Volume (vph)	40	1	28	4	2	0	25	1776	3	3	8	2026
Future Volume (vph)	40	1	28	4	2	0	25	1776	3	3	8	2026
Ideal Flow (vphpl)	1900	1900	1900	1900	1900	1900	1900	1900	1900	1900	1900	1900
Storage Length (ft)	0		0	0		0	100		0		100	
Storage Lanes	0		0	0		0	1		0		1	
Taper Length (ft)	25			25			25				25	
Lane Util. Factor	0.95	0.95	0.95	1.00	1.00	1.00	1.00	0.91	0.91	0.91	1.00	0.91
Fit		0.939										0.998
Fit Protected		0.972			0.968		0.950				0.950	
Satd. Flow (prot)	0	3230	0	0	1803	0	1770	5085	0	0	1770	5075
Fit Permitted		0.806			0.884		0.054				0.073	
Satd. Flow (perm)	0	2679	0	0	1647	0	101	5085	0	0	136	5075
Right Turn on Red			Yes			Yes			Yes			
Satd. Flow (RTOR)		31										2
Link Speed (mph)		30			30			42				38
Link Distance (ft)		303			249			252				191
Travel Time (s)		6.9			5.7			4.1				3.4
Peak Hour Factor	0.90	0.90	0.90	0.90	0.90	0.90	0.90	0.90	0.90	0.90	0.90	0.90
Adj. Flow (vph)	44	1	31	4	2	0	28	1973	3	3	9	2251
Shared Lane Traffic (%)												
Lane Group Flow (vph)	0	76	0	0	6	0	28	1976	0	0	12	2283
Enter Blocked Intersection	No	No	No	No	No	No	No	No	No	No	No	No
Lane Alignment	Left	Left	Right	Left	Left	Right	Left	Left	Right	R NA	Left	Left
Median Width(ft)		0			0			12				12
Link Offset(ft)		0			0			0				0
Crosswalk Width(ft)		16			16			16				16
Two way Left Turn Lane												
Headway Factor	1.00	1.00	1.00	1.00	1.00	1.00	1.00	1.00	1.00	1.00	1.00	1.00
Turning Speed (mph)	15		9	15		9	15		9	9	15	
Number of Detectors	1	1		1	1		1	1		1	1	1
Detector Template												
Leading Detector (ft)	50	50		50	50		50	50		50	50	50
Trailing Detector (ft)	0	0		0	0		0	0		0	0	0
Detector 1 Position(ft)	0	0		0	0		0	0		0	0	0
Detector 1 Size(ft)	50	50		50	50		50	50		50	50	50
Detector 1 Type	CI+Ex	CI+Ex		CI+Ex	CI+Ex		CI+Ex	CI+Ex		CI+Ex	CI+Ex	CI+Ex
Detector 1 Channel												
Detector 1 Extend (s)	0.0	0.0		0.0	0.0		0.0	0.0		0.0	0.0	0.0
Detector 1 Queue (s)	0.0	0.0		0.0	0.0		0.0	0.0		0.0	0.0	0.0
Detector 1 Delay (s)	0.0	0.0		0.0	0.0		0.0	0.0		0.0	0.0	0.0
Turn Type	Perm	NA		Perm	NA		D.P+P	NA		custom	D.P+P	NA
Protected Phases		8			4		1	6			5	2
Permitted Phases	8			4			2			5	6	
Detector Phase	8	8		4	4		1	6		5	5	2
Switch Phase												
Minimum Initial (s)	20.0	20.0		20.0	20.0		5.0	20.0		5.0	5.0	20.0
Minimum Split (s)	25.0	25.0		25.0	25.0		10.0	26.0		10.0	10.0	26.0
Total Split (s)	47.0	47.0		47.0	47.0		20.0	98.0		15.0	15.0	93.0

Pepper Square TIA  
Lanes, Volumes, Timings

Phase 1 - 2026 - Background - AM  
1369: Preston & Belt Line Village Driveway

Lane Group	SBR
Link Configurations	
Traffic Volume (vph)	29
Future Volume (vph)	29
Ideal Flow (vphpl)	1900
Storage Length (ft)	0
Storage Lanes	0
Taper Length (ft)	
Lane Util. Factor	0.91
Frnt	
Fit Protected	
Satd. Flow (prot)	0
Fit Permitted	
Satd. Flow (perm)	0
Right Turn on Red	Yes
Satd. Flow (RTOR)	
Link Speed (mph)	
Link Distance (ft)	
Travel Time (s)	
Peak Hour Factor	0.90
Adj. Flow (vph)	32
Shared Lane Traffic (%)	
Lane Group Flow (vph)	0
Enter Blocked Intersection	No
Lane Alignment	Right
Median Width(ft)	
Link Offset(ft)	
Crosswalk Width(ft)	
Two way Left Turn Lane	
Headway Factor	1.00
Turning Speed (mph)	9
Number of Detectors	
Detector Template	
Leading Detector (ft)	
Trailing Detector (ft)	
Detector 1 Position(ft)	
Detector 1 Size(ft)	
Detector 1 Type	
Detector 1 Channel	
Detector 1 Extend (s)	
Detector 1 Queue (s)	
Detector 1 Delay (s)	
Turn Type	
Protected Phases	
Permitted Phases	
Detector Phase	
Switch Phase	
Minimum Initial (s)	
Minimum Split (s)	
Total Split (s)	

Pepper Square TIA  
Lanes, Volumes, Timings

Phase 1 - 2026 - Background - AM  
1369: Preston & Belt Line Village Driveway

Lane Group	EBL	EBT	EBR	WBL	WBT	WBR	NBL	NBT	NBR	SBU	SBL	SBT
Total Split (%)	29.4%	29.4%		29.4%	29.4%		12.5%	61.3%		9.4%	9.4%	58.1%
Maximum Green (s)	42.3	42.3		42.3	42.3		15.0	93.7		10.0	10.0	88.7
Yellow Time (s)	3.0	3.0		3.0	3.0		3.0	3.0		3.0	3.0	3.0
All-Red Time (s)	1.7	1.7		1.7	1.7		2.0	1.3		2.0	2.0	1.3
Lost Time Adjust (s)		-1.0			-1.0		-1.0	-2.0			-1.0	-2.0
Total Lost Time (s)		3.7			3.7		4.0	2.3			4.0	2.3
Lead/Lag							Lead	Lead		Lag	Lag	Lag
Lead-Lag Optimize?							Yes	Yes		Yes	Yes	Yes
Vehicle Extension (s)	2.0	2.0		2.0	2.0		1.5	3.0		1.5	1.5	3.3
Recall Mode	None	None		None	None		None	None		None	None	C-Max
Walk Time (s)	5.0	5.0		5.0	5.0		7.0					7.0
Flash Dont Walk (s)	15.0	15.0		15.0	15.0		8.0					8.0
Pedestrian Calls (#/hr)	0	0		0	0		0					0
Act Effect Green (s)		21.0			21.0		128.9	117.8			129.7	127.0
Actuated g/C Ratio		0.13			0.13		0.81	0.74			0.81	0.79
v/c Ratio		0.20			0.03		0.20	0.53			0.04	0.57
Control Delay		39.2			61.2		5.2	6.6			1.0	2.6
Queue Delay		0.0			0.0		0.0	0.0			0.0	0.1
Total Delay		39.2			61.2		5.2	6.7			1.0	2.6
LOS		D			E		A	A			A	A
Approach Delay		39.2			61.2			6.6				2.6
Approach LOS		D			E			A				A
Queue Length 50th (ft)		22			6		1	23			1	59
Queue Length 95th (ft)		50			22		m2	236			m1	66
Internal Link Dist (ft)		223			169			172				111
Turn Bay Length (ft)							100				100	
Base Capacity (vph)		747			445		249	3755			316	4027
Starvation Cap Reductn		0			0		0	130			0	332
Spillback Cap Reductn		0			0		0	193			0	0
Storage Cap Reductn		0			0		0	0			0	0
Reduced v/c Ratio		0.10			0.01		0.11	0.55			0.04	0.62

Intersection Summary

Area Type: Other  
 Cycle Length: 160  
 Actuated Cycle Length: 160  
 Offset: 86 (54%), Referenced to phase 2:NBSB, Start of Yellow  
 Natural Cycle: 70  
 Control Type: Actuated-Coordinated  
 Maximum v/c Ratio: 0.57  
 Intersection Signal Delay: 5.2 Intersection LOS: A  
 Intersection Capacity Utilization 63.1% ICU Level of Service B  
 Analysis Period (min) 15  
 m Volume for 95th percentile queue is metered by upstream signal.

Splits and Phases: 1369: Preston & Belt Line Village Driveway

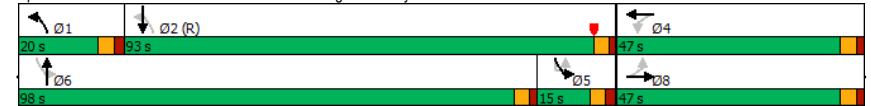

Pepper Square TIA  
Lanes, Volumes, Timings

Phase 1 - 2026 - Background - AM  
1369: Preston & Belt Line Village Driveway

Lane Group	SBR
Total Split (%)	
Maximum Green (s)	
Yellow Time (s)	
All-Red Time (s)	
Lost Time Adjust (s)	
Total Lost Time (s)	
Lead/Lag	
Lead-Lag Optimize?	
Vehicle Extension (s)	
Recall Mode	
Walk Time (s)	
Flash Dont Walk (s)	
Pedestrian Calls (#/hr)	
Act Effect Green (s)	
Actuated g/C Ratio	
v/c Ratio	
Control Delay	
Queue Delay	
Total Delay	
LOS	
Approach Delay	
Approach LOS	
Queue Length 50th (ft)	
Queue Length 95th (ft)	
Internal Link Dist (ft)	
Turn Bay Length (ft)	
Base Capacity (vph)	
Starvation Cap Reductn	
Spillback Cap Reductn	
Storage Cap Reductn	
Reduced v/c Ratio	
Intersection Summary	

Pepper Square TIA  
Lanes, Volumes, Timings

Phase 1 - 2026 - Background - AM  
1371: Preston & Spring Valley

Lane Group	EBL	EBT	EBR	WBL	WBT	WBR	NBL	NBT	NBR	SBU	SBL	SBT
Lane Configurations	↑↑	↑↑↑		↑↑	↑↑↑		↑↑	↑↑↑			↑↑	↑↑↑
Traffic Volume (vph)	145	362	250	89	729	145	114	1551	75	1	142	1969
Future Volume (vph)	145	362	250	89	729	145	114	1551	75	1	142	1969
Ideal Flow (vphpl)	1900	1900	1900	1900	1900	1900	1900	1900	1900	1900	1900	1900
Storage Length (ft)	225		0	225		0	225		0		275	
Storage Lanes	2		0	2		0	2		0		2	
Taper Length (ft)	25			25			25				25	
Lane Util. Factor	0.97	0.91	0.91	0.97	0.91	0.91	0.97	0.91	0.91	0.91	0.97	0.91
Frt		0.939			0.975			0.993				0.988
Fit Protected	0.950			0.950			0.950				0.950	
Satd. Flow (prot)	3433	4775	0	3433	4958	0	3433	5050	0	0	3433	5024
Fit Permitted	0.950			0.950			0.950				0.950	
Satd. Flow (perm)	3433	4775	0	3433	4958	0	3433	5050	0	0	3433	5024
Right Turn on Red			Yes			Yes			Yes			
Satd. Flow (RTOR)		103			25			6				14
Link Speed (mph)		38			42			41				38
Link Distance (ft)		3259			5488			2139				1208
Travel Time (s)		58.5			89.1			35.6				21.7
Peak Hour Factor	0.96	0.96	0.96	0.96	0.96	0.96	0.96	0.96	0.96	0.96	0.96	0.96
Adj. Flow (vph)	151	377	260	93	759	151	119	1616	78	1	148	2051
Shared Lane Traffic (%)												
Lane Group Flow (vph)	151	637	0	93	910	0	119	1694	0	0	149	2234
Enter Blocked Intersection	No	No	No	No	No	No	No	No	No	No	No	No
Lane Alignment	Left	Left	Right	Left	Left	Right	Left	Left	Right	R NA	Left	Left
Median Width(ft)		24			24			24				24
Link Offset(ft)		0			0			0				0
Crosswalk Width(ft)		16			16			16				16
Two way Left Turn Lane												
Headway Factor	1.00	1.00	1.00	1.00	1.00	1.00	1.00	1.00	1.00	1.00	1.00	1.00
Turning Speed (mph)	15		9	15		9	15		9	9	15	
Number of Detectors	1	1		1	1		1	1		1	1	1
Detector Template												
Leading Detector (ft)	50	50		50	50		50	50		50	50	50
Trailing Detector (ft)	0	0		0	0		0	0		0	0	0
Detector 1 Position(ft)	0	0		0	0		0	0		0	0	0
Detector 1 Size(ft)	50	50		50	50		50	50		50	50	50
Detector 1 Type	Cl+Ex	Cl+Ex		Cl+Ex	Cl+Ex		Cl+Ex	Cl+Ex		Cl+Ex	Cl+Ex	Cl+Ex
Detector 1 Channel												
Detector 1 Extend (s)	0.0	0.0		0.0	0.0		0.0	0.0		0.0	0.0	0.0
Detector 1 Queue (s)	0.0	0.0		0.0	0.0		0.0	0.0		0.0	0.0	0.0
Detector 1 Delay (s)	0.0	0.0		0.0	0.0		0.0	0.0		0.0	0.0	0.0
Turn Type	Prot	NA		Prot	NA		Prot	NA		Prot	Prot	NA
Protected Phases	3	8		7	4		1	6		5	5	2
Permitted Phases												
Detector Phase	3	8		7	4		1	6		5	5	2
Switch Phase												
Minimum Initial (s)	6.0	12.0		3.0	12.0		3.0	13.0		3.0	3.0	18.0
Minimum Split (s)	11.0	27.5		11.0	27.5		11.0	28.0		11.0	11.0	28.0
Total Split (s)	15.0	43.0		16.0	44.0		13.0	71.0		30.0	30.0	88.0



Pepper Square TIA  
Lanes, Volumes, Timings

Phase 1 - 2026 - Background - AM  
1371: Preston & Spring Valley

Lane Group	SBR
Link Configurations	
Traffic Volume (vph)	176
Future Volume (vph)	176
Ideal Flow (vphpl)	1900
Storage Length (ft)	0
Storage Lanes	0
Taper Length (ft)	
Lane Util. Factor	0.91
Frnt	
Fit Protected	
Satd. Flow (prot)	0
Fit Permitted	
Satd. Flow (perm)	0
Right Turn on Red	Yes
Satd. Flow (RTOR)	
Link Speed (mph)	
Link Distance (ft)	
Travel Time (s)	
Peak Hour Factor	0.96
Adj. Flow (vph)	183
Shared Lane Traffic (%)	
Lane Group Flow (vph)	0
Enter Blocked Intersection	No
Lane Alignment	Right
Median Width(ft)	
Link Offset(ft)	
Crosswalk Width(ft)	
Two way Left Turn Lane	
Headway Factor	1.00
Turning Speed (mph)	9
Number of Detectors	
Detector Template	
Leading Detector (ft)	
Trailing Detector (ft)	
Detector 1 Position(ft)	
Detector 1 Size(ft)	
Detector 1 Type	
Detector 1 Channel	
Detector 1 Extend (s)	
Detector 1 Queue (s)	
Detector 1 Delay (s)	
Turn Type	
Protected Phases	
Permitted Phases	
Detector Phase	
Switch Phase	
Minimum Initial (s)	
Minimum Split (s)	
Total Split (s)	

Pepper Square TIA  
Lanes, Volumes, Timings

Phase 1 - 2026 - Background - AM  
1371: Preston & Spring Valley

Lane Group	EBL	EBT	EBR	WBL	WBT	WBR	NBL	NBT	NBR	SBU	SBL	SBT
Total Split (%)	9.4%	26.9%		10.0%	27.5%		8.1%	44.4%		18.8%	18.8%	55.0%
Maximum Green (s)	10.0	37.5		11.0	38.5		8.0	65.0		25.0	25.0	82.0
Yellow Time (s)	3.0	4.0		3.0	4.0		3.0	4.5		3.0	3.0	4.5
All-Red Time (s)	2.0	1.5		2.0	1.5		2.0	1.5		2.0	2.0	1.5
Lost Time Adjust (s)	-1.0	-1.5		-1.0	-1.5		-1.0	-2.0			-1.0	-2.0
Total Lost Time (s)	4.0	4.0		4.0	4.0		4.0	4.0			4.0	4.0
Lead/Lag	Lead	Lead		Lag	Lag		Lead	Lead		Lag	Lag	Lag
Lead-Lag Optimize?	Yes	Yes		Yes	Yes		Yes	Yes		Yes	Yes	Yes
Vehicle Extension (s)	0.8	2.0		0.8	2.0		0.8	2.5		0.8	0.8	2.4
Recall Mode	None	None		None	None		None	None		None	None	C-Max
Walk Time (s)		4.0			4.0			4.0				4.0
Flash Dont Walk (s)		18.0			18.0			18.0				18.0
Pedestrian Calls (#/hr)		0			0			0				0
Act Effect Green (s)	10.1	24.3		20.7	34.8		9.0	65.7			33.4	90.1
Actuated g/C Ratio	0.06	0.15		0.13	0.22		0.06	0.41			0.21	0.56
v/c Ratio	0.70	0.79		0.21	0.83		0.62	0.82			0.21	0.79
Control Delay	81.3	58.8		63.2	59.6		90.6	48.9			67.5	41.2
Queue Delay	0.0	0.0		0.0	0.0		0.0	0.0			0.0	0.0
Total Delay	81.3	58.8		63.2	59.6		90.6	48.9			67.5	41.2
LOS	F	E		E	E		F	D			E	D
Approach Delay		63.1			60.0			51.7				42.8
Approach LOS		E			E			D				D
Queue Length 50th (ft)	80	214		48	344		65	469			76	825
Queue Length 95th (ft)	121	250		m45	m319		m102	480			m110	929
Internal Link Dist (ft)		3179			5408			2059				1128
Turn Bay Length (ft)	225			225			225				275	
Base Capacity (vph)	236	1241		443	1258		205	2118			717	2834
Starvation Cap Reductn	0	0		0	0		0	0			0	0
Spillback Cap Reductn	0	0		0	0		0	0			0	0
Storage Cap Reductn	0	0		0	0		0	0			0	0
Reduced v/c Ratio	0.64	0.51		0.21	0.72		0.58	0.80			0.21	0.79

Intersection Summary

Area Type: Other  
 Cycle Length: 160  
 Actuated Cycle Length: 160  
 Offset: 156 (98%), Referenced to phase 2:SBT, Start of Yellow  
 Natural Cycle: 90  
 Control Type: Actuated-Coordinated  
 Maximum v/c Ratio: 0.83  
 Intersection Signal Delay: 51.0 Intersection LOS: D  
 Intersection Capacity Utilization 80.9% ICU Level of Service D  
 Analysis Period (min) 15  
 m Volume for 95th percentile queue is metered by upstream signal.

Splits and Phases: 1371: Preston & Spring Valley

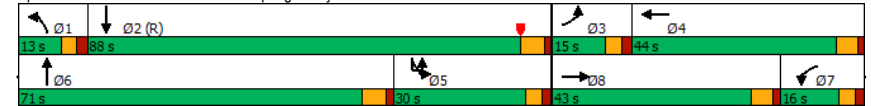

Pepper Square TIA  
Lanes, Volumes, Timings

Phase 1 - 2026 - Background - AM  
1371: Preston & Spring Valley

Lane Group	SBR
Total Split (%)	
Maximum Green (s)	
Yellow Time (s)	
All-Red Time (s)	
Lost Time Adjust (s)	
Total Lost Time (s)	
Lead/Lag	
Lead-Lag Optimize?	
Vehicle Extension (s)	
Recall Mode	
Walk Time (s)	
Flash Dont Walk (s)	
Pedestrian Calls (#/hr)	
Act Effect Green (s)	
Actuated g/C Ratio	
v/c Ratio	
Control Delay	
Queue Delay	
Total Delay	
LOS	
Approach Delay	
Approach LOS	
Queue Length 50th (ft)	
Queue Length 95th (ft)	
Internal Link Dist (ft)	
Turn Bay Length (ft)	
Base Capacity (vph)	
Starvation Cap Reductn	
Spillback Cap Reductn	
Storage Cap Reductn	
Reduced v/c Ratio	
Intersection Summary	

Pepper Square TIA  
Lanes, Volumes, Timings

Phase 1 - 2026 - Background - AM  
1405: Prestonwood & Belt Line

Lane Group	EBU	EBL	EBT	EBR	WBL	WBT	WBR	NBL	NBT	NBR	SBL	SBT
Lane Configurations		↕ ↕ ↕	↕ ↕ ↕		↕ ↕ ↕	↕ ↕ ↕		↕ ↕ ↕	↕ ↕ ↕		↕ ↕ ↕	↕ ↕ ↕
Traffic Volume (vph)	4	41	728	3	4	1400	48	1	0	5	39	1
Future Volume (vph)	4	41	728	3	4	1400	48	1	0	5	39	1
Ideal Flow (vphpl)	1900	1900	1900	1900	1900	1900	1900	1900	1900	1900	1900	1900
Storage Length (ft)		200		0	200		0	0		0	300	
Storage Lanes		1		0	1		0	0		0	2	
Taper Length (ft)		25			25			25			25	
Lane Util. Factor	0.91	1.00	0.91	0.91	1.00	0.91	0.91	1.00	1.00	1.00	0.97	0.95
Fit			0.999			0.995			0.887			0.854
Fit Protected		0.950			0.950				0.992			0.950
Satd. Flow (prot)	0	1770	5080	0	1770	5060	0	0	1639	0	3433	1511
Fit Permitted		0.142			0.346				0.992			0.950
Satd. Flow (perm)	0	265	5080	0	645	5060	0	0	1639	0	3433	1511
Right Turn on Red			Yes			Yes			Yes			
Satd. Flow (RTOR)			1			7			131			33
Link Speed (mph)			42			42			30			30
Link Distance (ft)			1445			2036			315			868
Travel Time (s)			23.5			33.1			7.2			19.7
Peak Hour Factor	0.95	0.95	0.95	0.95	0.95	0.95	0.95	0.95	0.95	0.95	0.95	0.95
Adj. Flow (vph)	4	43	766	3	4	1474	51	1	0	5	41	1
Shared Lane Traffic (%)												
Lane Group Flow (vph)	0	47	769	0	4	1525	0	0	6	0	41	34
Enter Blocked Intersection	No	No	No	No	No	No	No	No	No	No	No	No
Lane Alignment	R NA	Left	Left	Right	Left	Left	Right	Left	Left	Right	Left	Left
Median Width(ft)			24			24			24			24
Link Offset(ft)			0			0			0			0
Crosswalk Width(ft)			16			16			16			16
Two way Left Turn Lane												
Headway Factor	1.00	1.00	1.00	1.00	1.00	1.00	1.00	1.00	1.00	1.00	1.00	1.00
Turning Speed (mph)	9	15		9	15		9	15		9	15	
Number of Detectors	1	1	1		1	1		1	1		1	1
Detector Template												
Leading Detector (ft)	50	50	50		50	50		50	50		50	50
Trailing Detector (ft)	0	0	0		0	0		0	0		0	0
Detector 1 Position(ft)	0	0	0		0	0		0	0		0	0
Detector 1 Size(ft)	50	50	50		50	50		50	50		50	50
Detector 1 Type	CI+Ex	CI+Ex	CI+Ex		CI+Ex	CI+Ex		CI+Ex	CI+Ex		CI+Ex	CI+Ex
Detector 1 Channel												
Detector 1 Extend (s)	0.0	0.0	0.0		0.0	0.0		0.0	0.0		0.0	0.0
Detector 1 Queue (s)	0.0	0.0	0.0		0.0	0.0		0.0	0.0		0.0	0.0
Detector 1 Delay (s)	0.0	0.0	0.0		0.0	0.0		0.0	0.0		0.0	0.0
Turn Type	custom	D,P+P	NA		D,P+P	NA		Split	NA		Split	NA
Permitted Phases		1	6		5	2		3	3		4	4
Permitted Phases	1	2			6							
Detector Phase	1	1	6		5	2		3	3		4	4
Switch Phase												
Minimum Initial (s)	3.0	3.0	15.0		3.0	15.0		5.0	5.0		7.0	7.0
Minimum Split (s)	8.0	8.0	22.0		8.0	24.0		23.0	23.0		23.2	23.2
Total Split (s)	15.0	15.0	109.0		15.0	109.0		18.0	18.0		18.0	18.0

Pepper Square TIA  
Lanes, Volumes, Timings

Phase 1 - 2026 - Background - AM  
1405: Prestonwood & Belt Line

Lane Group	SBR
Lane Configurations	↑
Traffic Volume (vph)	64
Future Volume (vph)	64
Ideal Flow (vphpl)	1900
Storage Length (ft)	0
Storage Lanes	1
Taper Length (ft)	
Lane Util. Factor	0.95
Frt	0.850
Fit Protected	
Satd. Flow (prot)	1504
Fit Permitted	
Satd. Flow (perm)	1504
Right Turn on Red	Yes
Satd. Flow (RTOR)	89
Link Speed (mph)	
Link Distance (ft)	
Travel Time (s)	
Peak Hour Factor	0.95
Adj. Flow (vph)	67
Shared Lane Traffic (%)	49%
Lane Group Flow (vph)	34
Enter Blocked Intersection	No
Lane Alignment	Right
Median Width(ft)	
Link Offset(ft)	
Crosswalk Width(ft)	
Two way Left Turn Lane	
Headway Factor	1.00
Turning Speed (mph)	9
Number of Detectors	1
Detector Template	
Leading Detector (ft)	50
Trailing Detector (ft)	0
Detector 1 Position(ft)	0
Detector 1 Size(ft)	50
Detector 1 Type	CI+Ex
Detector 1 Channel	
Detector 1 Extend (s)	0.0
Detector 1 Queue (s)	0.0
Detector 1 Delay (s)	0.0
Turn Type	custom
Protected Phases	
Permitted Phases	1 4
Detector Phase	1 4
Switch Phase	
Minimum Initial (s)	
Minimum Split (s)	
Total Split (s)	

Pepper Square TIA  
Lanes, Volumes, Timings

Phase 1 - 2026 - Background - AM  
1405: Prestonwood & Belt Line

Lane Group	EBU	EBL	EBT	EBR	WBL	WBT	WBR	NBL	NBT	NBR	SBL	SBT
Total Split (%)	9.4%	9.4%	68.1%		9.4%	68.1%		11.3%	11.3%		11.3%	11.3%
Maximum Green (s)	10.0	10.0	103.0		10.0	103.0		13.0	13.0		12.8	12.8
Yellow Time (s)	3.0	3.0	4.5		3.0	4.5		3.0	3.0		3.2	3.2
All-Red Time (s)	2.0	2.0	1.5		2.0	1.5		2.0	2.0		2.0	2.0
Lost Time Adjust (s)		-1.0	-2.0		-1.0	-2.0		-1.0			-1.2	-1.2
Total Lost Time (s)		4.0	4.0		4.0	4.0		4.0			4.0	4.0
Lead/Lag	Lag	Lag	Lag		Lead	Lead		Lead	Lead		Lag	Lag
Lead-Lag Optimize?	Yes	Yes	Yes		Yes	Yes		Yes	Yes		Yes	Yes
Vehicle Extension (s)	1.0	1.0	2.5		1.0	2.5		1.5	1.5		1.5	1.5
Recall Mode	None	None	C-Max		None	Max		None	None		None	None
Walk Time (s)			5.0		4.0			4.0	4.0		4.0	4.0
Flash Dont Walk (s)			10.0		14.0			14.0	14.0		14.0	14.0
Pedestrian Calls (#/hr)			0		0			0	0		0	0
Act Effect Green (s)		141.7	143.1		143.3	132.9		6.0			8.4	8.4
Actuated g/C Ratio		0.89	0.89		0.90	0.83		0.04			0.05	0.05
v/c Ratio		0.14	0.17		0.01	0.36		0.03			0.23	0.31
Control Delay		3.6	1.5		0.8	1.8		0.3			75.9	29.8
Queue Delay		0.0	0.0		0.0	0.0		0.0			0.0	0.0
Total Delay		3.6	1.5		0.8	1.8		0.3			75.9	29.8
LOS		A	A		A	A		A			E	C
Approach Delay			1.6			1.8		0.3				38.2
Approach LOS			A			A		A				D
Queue Length 50th (ft)		3	20		0	52		0			21	1
Queue Length 95th (ft)		12	58		m1	75		0			43	41
Internal Link Dist (ft)			1365			1956		235				788
Turn Bay Length (ft)		200			200						300	
Base Capacity (vph)		337	4544		658	4203		262			300	162
Starvation Cap Reductn		0	0		0	0		0			0	0
Spillback Cap Reductn		0	0		0	0		0			0	0
Storage Cap Reductn		0	0		0	0		0			0	0
Reduced v/c Ratio		0.14	0.17		0.01	0.36		0.02			0.14	0.21

Intersection Summary

Area Type: Other  
 Cycle Length: 160  
 Actuated Cycle Length: 160  
 Offset: 73 (46%), Referenced to phase 6:EBWB, Start of Yellow  
 Natural Cycle: 80  
 Control Type: Actuated-Coordinated  
 Maximum v/c Ratio: 0.36  
 Intersection Signal Delay: 3.4  
 Intersection Capacity Utilization 52.3%  
 Analysis Period (min) 15  
 m Volume for 95th percentile queue is metered by upstream signal.

Splits and Phases: 1405: Prestonwood & Belt Line



Lane Group	SBR
Total Split (%)	
Maximum Green (s)	
Yellow Time (s)	
All-Red Time (s)	
Lost Time Adjust (s)	
Total Lost Time (s)	
Lead/Lag	
Lead-Lag Optimize?	
Vehicle Extension (s)	
Recall Mode	
Walk Time (s)	
Flash Dont Walk (s)	
Pedestrian Calls (#/hr)	
Act Effect Green (s)	20.5
Actuated g/C Ratio	0.13
v/c Ratio	0.13
Control Delay	1.0
Queue Delay	0.0
Total Delay	1.0
LOS	A
Approach Delay	
Approach LOS	
Queue Length 50th (ft)	0
Queue Length 95th (ft)	0
Internal Link Dist (ft)	
Turn Bay Length (ft)	
Base Capacity (vph)	338
Starvation Cap Reductn	0
Spillback Cap Reductn	0
Storage Cap Reductn	0
Reduced v/c Ratio	0.10
Intersection Summary	

Pepper Square TIA  
HCM 6th TWSC

Phase 1 - 2026 - Background - AM  
2: Ladera Drive & Belt Line

Intersection												
Int Delay, s/veh	3.5											
Movement	EBL	EBT	EBR	WBL	WBT	WBR	NBL	NBT	NBR	SBL	SBT	SBR
Lane Configurations	↔ ↑↑↑			↔ ↑↑↑				↕		↕		
Traffic Vol, veh/h	44	715	15	23	1299	16	41	0	65	28	0	94
Future Vol, veh/h	44	715	15	23	1299	16	41	0	65	28	0	94
Conflicting Peds, #/hr	0	0	0	0	0	0	0	0	0	0	0	0
Sign Control	Free	Free	Free	Free	Free	Free	Stop	Stop	Stop	Stop	Stop	Stop
RT Channelized	-	-	None	-	-	None	-	-	None	-	-	None
Storage Length	100	-	-	100	-	-	-	-	0	-	-	0
Veh in Median Storage, #	-	0	-	-	0	-	-	1	-	-	1	-
Grade, %	-	0	-	-	0	-	-	0	-	-	0	-
Peak Hour Factor	91	91	91	91	91	91	91	91	91	91	91	91
Heavy Vehicles, %	2	2	2	2	2	2	2	2	2	2	2	2
Mvmt Flow	48	786	16	25	1427	18	45	0	71	31	0	103

Major/Minor	Major1	Major2	Minor1	Minor2
Conflicting Flow All	1445	0	0	802
Stage 1	-	-	-	-
Stage 2	-	-	-	-
Critical Hdwy	5.34	-	-	5.34
Critical Hdwy Stg 1	-	-	-	-
Critical Hdwy Stg 2	-	-	-	-
Follow-up Hdwy	3.12	-	-	3.12
Pot Cap-1 Maneuver	237	-	-	884
Stage 1	-	-	-	-
Stage 2	-	-	-	-
Platoon blocked, %	-	-	-	-
Mov Cap-1 Maneuver	237	-	-	884
Mov Cap-2 Maneuver	-	-	-	-
Stage 1	-	-	-	-
Stage 2	-	-	-	-

Approach	EB	WB	NB	SB
HCM Control Delay, s	1.4	0.2	18.4	39.8
HCM LOS			C	E

Minor Lane/Major Mvmt	NBLn1	NBLn2	EBL	EBT	EBR	WBL	WBT	WBR	SBLn1	SBLn2
Capacity (veh/h)	181	768	237	-	-	884	-	-	66	316
HCM Lane V/C Ratio	0.249	0.093	0.204	-	-	0.029	-	-	0.466	0.327
HCM Control Delay (s)	31.4	10.2	24	-	-	9.2	-	-	100.3	21.8
HCM Lane LOS	D	B	C	-	-	A	-	-	F	C
HCM 95th %tile Q(veh)	0.9	0.3	0.7	-	-	0.1	-	-	1.8	1.4

Notes  
 ~: Volume exceeds capacity    \$: Delay exceeds 300s    +: Computation Not Defined    \*: All major volume in platoon

Pepper Square TIA  
HCM 6th TWSC

Phase 1 - 2026 - Background - AM  
3: Median Opening East of Preston Rd & Belt Line

Intersection													
Int Delay, s/veh	0.3												
Movement	EBU	EBL	EBT	EBR	WBL	WBT	WBR	NBL	NBT	NBR	SBL	SBT	SBR
Lane Configurations	↔ ↑↑↑			↔ ↑↑↑				↕		↕			
Traffic Vol, veh/h	4	21	507	4	13	1033	17	1	2	0	1	0	3
Future Vol, veh/h	4	21	507	4	13	1033	17	1	2	0	1	0	3
Conflicting Peds, #/hr	0	0	0	0	0	0	0	0	0	0	0	0	0
Sign Control	Free	Free	Free	Free	Free	Free	Free	Stop	Stop	Stop	Stop	Stop	Stop
RT Channelized	-	-	-	None	-	-	None	-	-	None	-	-	None
Storage Length	-	150	-	-	200	-	-	-	-	-	-	-	-
Veh in Median Storage, #	-	-	0	-	-	0	-	-	1	-	-	1	-
Grade, %	-	-	0	-	-	0	-	-	0	-	-	0	-
Peak Hour Factor	96	96	96	96	96	96	96	96	96	96	96	96	96
Heavy Vehicles, %	2	2	2	2	2	2	2	2	2	2	2	2	2
Mvmt Flow	4	22	528	4	14	1076	18	1	2	0	1	0	3

Major/Minor	Major1	Major2	Minor1	Minor2
Conflicting Flow All	798	1094	0	0
Stage 1	-	-	-	-
Stage 2	-	-	-	-
Critical Hdwy	5.64	5.34	-	-
Critical Hdwy Stg 1	-	-	-	-
Critical Hdwy Stg 2	-	-	-	-
Follow-up Hdwy	2.32	3.12	-	-
Pot Cap-1 Maneuver	*1161	*864	-	-
Stage 1	-	-	-	-
Stage 2	-	-	-	-
Platoon blocked, %	1	1	-	-
Mov Cap-1 Maneuver	*900	*900	-	-
Mov Cap-2 Maneuver	-	-	-	-
Stage 1	-	-	-	-
Stage 2	-	-	-	-

Approach	EB	WB	NB	SB
HCM Control Delay, s	0.4	0.1	13.8	10.8
HCM LOS			B	B

Minor Lane/Major Mvmt	NBLn1	EBL	EBT	EBR	WBL	WBT	WBR	SBLn1
Capacity (veh/h)	411	*900	-	-	654	-	-	628
HCM Lane V/C Ratio	0.008	0.029	-	-	0.021	-	-	0.007
HCM Control Delay (s)	13.8	9.1	-	-	10.6	-	-	10.8
HCM Lane LOS	B	A	-	-	B	-	-	B
HCM 95th %tile Q(veh)	0	0.1	-	-	0.1	-	-	0

Notes  
 ~: Volume exceeds capacity    \$: Delay exceeds 300s    +: Computation Not Defined    \*: All major volume in platoon

Pepper Square TIA  
HCM 6th TWSC

Phase 1 - 2026 - Background - AM  
5: Belt Line & Median between Berry Trail and Alexis Dr

Intersection												
Int Delay, s/veh	0.2											
Movement	EBL	EBT	EBR	WBL	WBT	WBR	NBL	NBT	NBR	SBL	SBT	SBR
Lane Configurations	↕ ↑↑↔			↕ ↑↑↔			↔			↔		
Traffic Vol, veh/h	5	542	0	11	1029	11	1	0	0	6	1	7
Future Vol, veh/h	5	542	0	11	1029	11	1	0	0	6	1	7
Conflicting Peds, #/hr	0	0	0	0	0	0	0	0	0	0	0	0
Sign Control	Free	Free	Free	Free	Free	Stop	Stop	Stop	Stop	Stop	Stop	Stop
RT Channelized	-	-	None	-	-	None	-	-	None	-	-	None
Storage Length	150	-	-	150	-	-	-	-	-	-	-	-
Veh in Median Storage, #	-	0	-	-	0	-	-	1	-	-	1	-
Grade, %	-	0	-	-	0	-	-	0	-	-	0	-
Peak Hour Factor	88	88	88	88	88	88	88	88	88	88	88	88
Heavy Vehicles, %	2	2	2	2	2	2	2	2	2	2	2	2
Mvmt Flow	6	616	0	13	1169	13	1	0	0	7	1	8

Major/Minor	Major1	Major2	Minor1	Minor2
Conflicting Flow All	1182	0	0	616
Stage 1	-	-	-	-
Stage 2	-	-	-	-
Critical Hdwy	5.34	-	-	5.34
Critical Hdwy Stg 1	-	-	-	-
Critical Hdwy Stg 2	-	-	-	-
Follow-up Hdwy	3.12	-	-	3.12
Pot Cap-1 Maneuver	802	-	-	956
Stage 1	-	-	-	-
Stage 2	-	-	-	-
Platoon blocked, %	1	-	-	1
Mov Cap-1 Maneuver	802	-	-	956
Mov Cap-2 Maneuver	-	-	-	-
Stage 1	-	-	-	-
Stage 2	-	-	-	-

Approach	EB	WB	NB	SB
HCM Control Delay, s	0.1	0.1	11.2	11.1
HCM LOS			B	B

Minor Lane/Major Mvmt	NBLn1	EBL	EBT	EBR	WBL	WBT	WBR	SBLn1
Capacity (veh/h)	585	802	-	-	956	-	-	604
HCM Lane V/C Ratio	0.002	0.007	-	-	0.013	-	-	0.026
HCM Control Delay (s)	11.2	9.5	-	-	8.8	-	-	11.1
HCM Lane LOS	B	A	-	-	A	-	-	B
HCM 95th %tile Q(veh)	0	0	-	-	0	-	-	0.1

Notes  
 ~: Volume exceeds capacity    \$: Delay exceeds 300s    +: Computation Not Defined    \*: All major volume in platoon

Pepper Square TIA  
HCM 6th TWSC

Phase 1 - 2026 - Background - AM  
6: Alexis Drive & Belt Line

Intersection						
Int Delay, s/veh	1.7					
Movement	EBT	EBR	WBL	WBT	NBL	NBR
Lane Configurations	↑↑↔		↕ ↑↑↔		↕ ↗	
Traffic Vol, veh/h	544	4	154	1029	8	144
Future Vol, veh/h	544	4	154	1029	8	144
Conflicting Peds, #/hr	0	0	0	0	0	0
Sign Control	Free	Free	Free	Free	Stop	Stop
RT Channelized	-	None	-	None	-	Yield
Storage Length	-	-	150	-	0	0
Veh in Median Storage, #	0	-	-	0	1	-
Grade, %	0	-	-	0	0	-
Peak Hour Factor	86	86	86	86	86	86
Heavy Vehicles, %	2	2	2	2	2	2
Mvmt Flow	633	5	179	1197	9	167

Major/Minor	Major1	Major2	Minor1
Conflicting Flow All	0	0	638
Stage 1	-	-	-
Stage 2	-	-	-
Critical Hdwy	-	-	5.34
Critical Hdwy Stg 1	-	-	-
Critical Hdwy Stg 2	-	-	-
Follow-up Hdwy	-	-	3.12
Pot Cap-1 Maneuver	-	-	931
Stage 1	-	-	-
Stage 2	-	-	-
Platoon blocked, %	-	-	1
Mov Cap-1 Maneuver	-	-	931
Mov Cap-2 Maneuver	-	-	-
Stage 1	-	-	-
Stage 2	-	-	-

Approach	EB	WB	NB
HCM Control Delay, s	0	1.3	10.8
HCM LOS			B

Minor Lane/Major Mvmt	NBLn1	NBLn2	EBT	EBR	WBL	WBT
Capacity (veh/h)	497	800	-	-	931	-
HCM Lane V/C Ratio	0.019	0.209	-	-	0.192	-
HCM Control Delay (s)	12.4	10.7	-	-	9.8	-
HCM Lane LOS	B	B	-	-	A	-
HCM 95th %tile Q(veh)	0.1	0.8	-	-	0.7	-

Notes  
 ~: Volume exceeds capacity    \$: Delay exceeds 300s    +: Computation Not Defined    \*: All major volume in platoon

Intersection													
Int Delay, s/veh	1.2												
Movement	EBL	EBT	EBR	WBL	WBT	WBR	NBL	NBT	NBR	SBL	SBT	SBR	
Lane Configurations	↔			↔			↕ ↕ ↕			↕ ↕ ↕			
Traffic Vol, veh/h	10	3	26	7	1	8	1	51	1820	18	1	15	1976
Future Vol, veh/h	10	3	26	7	1	8	1	51	1820	18	1	15	1976
Conflicting Peds, #/hr	0	0	0	0	0	0	0	0	0	0	0	0	0
Sign Control	Stop	Stop	Stop	Stop	Stop	Free	Free	Free	Free	Free	Free	Free	Free
RT Channelized	-	-	None	-	-	None	-	-	None	-	-	-	None
Storage Length	-	-	-	-	-	-	-	150	-	-	-	150	-
Veh in Median Storage, #	-	1	-	-	1	-	-	-	0	-	-	-	0
Grade, %	-	0	-	-	0	-	-	-	0	-	-	-	0
Peak Hour Factor	89	89	89	89	89	89	89	89	89	89	89	89	89
Heavy Vehicles, %	2	2	2	2	2	2	2	2	2	2	2	2	2
Mvmt Flow	11	3	29	8	1	9	1	57	2045	20	1	17	2220

Major/Minor	Minor2	Minor1	Major1	Major2
Conflicting Flow All	3229	4475	1148	3097
Stage 1	2294	2294	-	2171
Stage 2	935	2181	-	926
Critical Hdwy	6.44	6.54	7.14	6.44
Critical Hdwy Stg 1	7.34	5.54	-	7.34
Critical Hdwy Stg 2	6.74	5.54	-	6.74
Follow-up Hdwy	3.82	4.02	3.92	3.82
Pot Cap-1 Maneuver	33	-1	*460	*49
Stage 1	403	405	-	*29
Stage 2	258	83	-	*472
Platoon blocked, %	1	1	1	1
Mov Cap-1 Maneuver	26	0	*460	*37
Mov Cap-2 Maneuver	127	44	-	*23
Stage 1	358	344	-	*26
Stage 2	215	74	-	*372

Approach	EB	WB	NB	SB
HCM Control Delay, s	29.2	134.7	0.4	0.3
HCM LOS	D	F		

Minor Lane/Major Mvmt	NBL	NBT	NBR	EBLn1	WBLn1	SBL	SBT	SBR
Capacity (veh/h)	519	-	-	192	44	120	-	-
HCM Lane V/C Ratio	0.113	-	-	0.228	0.409	0.15	-	-
HCM Control Delay (s)	12.8	-	-	29.2	134.7	40.4	-	-
HCM Lane LOS	B	-	-	D	F	E	-	-
HCM 95th %tile Q(veh)	0.4	-	-	0.8	1.4	0.5	-	-

Notes  
 ~: Volume exceeds capacity    \$: Delay exceeds 300s    +: Computation Not Defined    \*: All major volume in platoon

Intersection						
Int Delay, s/veh	0					
Movement	WBL	WBR	NBT	NBR	SBL	SBT
Lane Configurations	↕ ↕ ↕			↕ ↕ ↕		
Traffic Vol, veh/h	0	2	1804	0	0	2065
Future Vol, veh/h	0	2	1804	0	0	2065
Conflicting Peds, #/hr	0	0	0	0	0	0
Sign Control	Stop	Stop	Free	Free	Free	Free
RT Channelized	-	None	-	None	-	None
Storage Length	-	0	-	-	-	-
Veh in Median Storage, #	0	-	0	-	-	0
Grade, %	0	-	0	-	-	0
Peak Hour Factor	92	92	92	92	92	92
Heavy Vehicles, %	2	2	2	2	2	2
Mvmt Flow	0	2	1961	0	0	2245

Major/Minor	Minor1	Major1	Major2
Conflicting Flow All	-	981	0
Stage 1	-	-	-
Stage 2	-	-	-
Critical Hdwy	-	7.14	-
Critical Hdwy Stg 1	-	-	-
Critical Hdwy Stg 2	-	-	-
Follow-up Hdwy	-	3.92	-
Pot Cap-1 Maneuver	0	214	-
Stage 1	0	-	-
Stage 2	0	-	-
Platoon blocked, %	-	-	-
Mov Cap-1 Maneuver	-	214	-
Mov Cap-2 Maneuver	-	-	-
Stage 1	-	-	-
Stage 2	-	-	-

Approach	WB	NB	SB
HCM Control Delay, s	22	0	0
HCM LOS	C		

Minor Lane/Major Mvmt	NBT	NBR	WBLn1	SBT
Capacity (veh/h)	-	-	214	-
HCM Lane V/C Ratio	-	-	0.01	-
HCM Control Delay (s)	-	-	22	-
HCM Lane LOS	-	-	C	-
HCM 95th %tile Q(veh)	-	-	0	-

Pepper Square TIA  
HCM 6th TWSC

Phase 1 - 2026 - Background - AM  
21: Preston & Drive 1

Intersection						
Int Delay, s/veh	0					
Movement	WBL	WBR	NBT	NBR	SBL	SBT
Lane Configurations		↑↑↑	↑↑↑			↑↑↑
Traffic Vol, veh/h	0	0	1890	0	0	2008
Future Vol, veh/h	0	0	1890	0	0	2008
Conflicting Peds, #/hr	0	0	0	0	0	0
Sign Control	Stop	Stop	Free	Free	Free	Free
RT Channelized	-	None	-	None	-	None
Storage Length	-	0	-	-	-	-
Veh in Median Storage, #	0	-	0	-	0	0
Grade, %	0	-	0	-	0	0
Peak Hour Factor	92	92	92	92	92	92
Heavy Vehicles, %	2	2	2	2	2	2
Mvmt Flow	0	0	2054	0	0	2183

Major/Minor	Minor1	Major1	Major2		
Conflicting Flow All	-	1027	0	0	-
Stage 1	-	-	-	-	-
Stage 2	-	-	-	-	-
Critical Hdwy	-	7.14	-	-	-
Critical Hdwy Stg 1	-	-	-	-	-
Critical Hdwy Stg 2	-	-	-	-	-
Follow-up Hdwy	-	3.92	-	-	-
Pot Cap-1 Maneuver	0	199	-	0	-
Stage 1	0	-	-	0	-
Stage 2	0	-	-	0	-
Platoon blocked, %	-	-	-	-	-
Mov Cap-1 Maneuver	-	199	-	-	-
Mov Cap-2 Maneuver	-	-	-	-	-
Stage 1	-	-	-	-	-
Stage 2	-	-	-	-	-

Approach	WB	NB	SB
HCM Control Delay, s	0	0	0
HCM LOS	A		

Minor Lane/Major Mvmt	NBT	NBRWBLn1	SBT
Capacity (veh/h)	-	-	-
HCM Lane V/C Ratio	-	-	-
HCM Control Delay (s)	-	0	-
HCM Lane LOS	-	A	-
HCM 95th %tile Q(veh)	-	-	-

Pepper Square TIA  
HCM 6th TWSC

Phase 1 - 2026 - Background - AM  
22: Drive 6 & Belt Line

Intersection						
Int Delay, s/veh	0					
Movement	EBT	EBR	WBL	WBT	NBL	NBR
Lane Configurations	↑↑↑			↑↑↑		↑
Traffic Vol, veh/h	507	0	0	1070	0	0
Future Vol, veh/h	507	0	0	1070	0	0
Conflicting Peds, #/hr	0	0	0	0	0	0
Sign Control	Free	Free	Free	Free	Stop	Stop
RT Channelized	-	None	-	None	-	None
Storage Length	-	-	-	-	-	0
Veh in Median Storage, #	0	-	-	0	0	-
Grade, %	0	-	-	0	0	-
Peak Hour Factor	96	96	96	96	96	96
Heavy Vehicles, %	2	2	2	2	2	2
Mvmt Flow	528	0	0	1115	0	0

Major/Minor	Major1	Major2	Minor1		
Conflicting Flow All	0	0	-	-	264
Stage 1	-	-	-	-	-
Stage 2	-	-	-	-	-
Critical Hdwy	-	-	-	-	7.14
Critical Hdwy Stg 1	-	-	-	-	-
Critical Hdwy Stg 2	-	-	-	-	-
Follow-up Hdwy	-	-	-	-	3.92
Pot Cap-1 Maneuver	-	0	-	0	626
Stage 1	-	0	-	0	-
Stage 2	-	0	-	0	-
Platoon blocked, %	-	-	-	-	-
Mov Cap-1 Maneuver	-	-	-	-	626
Mov Cap-2 Maneuver	-	-	-	-	-
Stage 1	-	-	-	-	-
Stage 2	-	-	-	-	-

Approach	EB	WB	NB
HCM Control Delay, s	0	0	0
HCM LOS			A

Minor Lane/Major Mvmt	NBLn1	EBT	EBR	WBT
Capacity (veh/h)	-	-	-	-
HCM Lane V/C Ratio	-	-	-	-
HCM Control Delay (s)	0	-	-	-
HCM Lane LOS	A	-	-	-
HCM 95th %tile Q(veh)	-	-	-	-



Pepper Square TIA  
HCM 6th TWSC

Phase 1 - 2026 - Background - AM  
24: Drive 5 & Belt Line

Intersection						
Int Delay, s/veh	0					
Movement	EBT	EBR	WBL	WBT	NBL	NBR
Lane Configurations	↑↑↑			↑↑↑		↑
Traffic Vol, veh/h	537	0	0	1022	0	0
Future Vol, veh/h	537	0	0	1022	0	0
Conflicting Peds, #/hr	0	0	0	0	0	0
Sign Control	Free	Free	Free	Free	Stop	Stop
RT Channelized	-	None	-	None	-	None
Storage Length	-	-	-	-	-	0
Veh in Median Storage, #	0	-	-	0	0	-
Grade, %	0	-	-	0	0	-
Peak Hour Factor	96	96	96	96	96	96
Heavy Vehicles, %	2	2	2	2	2	2
Mvmt Flow	559	0	0	1065	0	0

Major/Minor	Major1	Major2	Minor1
Conflicting Flow All	0	0	- 280
Stage 1	-	-	-
Stage 2	-	-	-
Critical Hdwy	-	-	- 7.14
Critical Hdwy Stg 1	-	-	-
Critical Hdwy Stg 2	-	-	-
Follow-up Hdwy	-	-	- 3.92
Pot Cap-1 Maneuver	-	0	- 0 611
Stage 1	-	0	- 0
Stage 2	-	0	- 0
Platoon blocked, %	-	-	-
Mov Cap-1 Maneuver	-	-	- 611
Mov Cap-2 Maneuver	-	-	-
Stage 1	-	-	-
Stage 2	-	-	-

Approach	EB	WB	NB
HCM Control Delay, s	0	0	0
HCM LOS			A

Minor Lane/Major Mvmt	NBLn1	EBT	EBR	WBT
Capacity (veh/h)	-	-	-	-
HCM Lane V/C Ratio	-	-	-	-
HCM Control Delay (s)	0	-	-	-
HCM Lane LOS	A	-	-	-
HCM 95th %tile Q(veh)	-	-	-	-

Pepper Square TIA  
HCM 6th TWSC

Phase 1 - 2026 - Background - AM  
25: Preston & Drive 4

Intersection						
Int Delay, s/veh	0					
Movement	WBL	WBR	NBT	NBR	SBL	SBT
Lane Configurations		↑↑↑	↑↑↑			↑↑↑
Traffic Vol, veh/h	0	5	1840	3	0	2065
Future Vol, veh/h	0	5	1840	3	0	2065
Conflicting Peds, #/hr	0	0	0	0	0	0
Sign Control	Stop	Stop	Free	Free	Free	Free
RT Channelized	-	None	-	None	-	None
Storage Length	-	0	-	-	-	-
Veh in Median Storage, #	0	-	0	-	-	0
Grade, %	0	-	0	-	-	0
Peak Hour Factor	92	92	92	92	92	92
Heavy Vehicles, %	2	2	2	2	2	2
Mvmt Flow	0	5	2000	3	0	2245

Major/Minor	Minor1	Major1	Major2
Conflicting Flow All	- 1002	0	0 -
Stage 1	-	-	-
Stage 2	-	-	-
Critical Hdwy	- 7.14	-	-
Critical Hdwy Stg 1	-	-	-
Critical Hdwy Stg 2	-	-	-
Follow-up Hdwy	- 3.92	-	-
Pot Cap-1 Maneuver	0 207	-	- 0 -
Stage 1	0	-	- 0 -
Stage 2	0	-	- 0 -
Platoon blocked, %	-	-	-
Mov Cap-1 Maneuver	- 207	-	-
Mov Cap-2 Maneuver	-	-	-
Stage 1	-	-	-
Stage 2	-	-	-

Approach	WB	NB	SB
HCM Control Delay, s	22.9	0	0
HCM LOS	C		

Minor Lane/Major Mvmt	NBT	NBRWBLn1	SBT
Capacity (veh/h)	-	- 207	-
HCM Lane V/C Ratio	-	- 0.026	-
HCM Control Delay (s)	-	- 22.9	-
HCM Lane LOS	-	- C	-
HCM 95th %tile Q(veh)	-	- 0.1	-

Intersection						
Int Delay, s/veh	0					
Movement	WBL	WBR	NBT	NBR	SBL	SBT
Lane Configurations			↑ ↑ ↑			↑ ↑ ↑
Traffic Vol, veh/h	0	3	1840	0	0	2065
Future Vol, veh/h	0	3	1840	0	0	2065
Conflicting Peds, #/hr	0	0	0	0	0	0
Sign Control	Stop	Stop	Free	Free	Free	Free
RT Channelized	-	None	-	None	-	None
Storage Length	-	0	-	-	-	-
Veh in Median Storage, #	0	-	0	-	-	0
Grade, %	0	-	0	-	-	0
Peak Hour Factor	92	92	92	92	92	92
Heavy Vehicles, %	2	2	2	2	2	2
Mvmt Flow	0	3	2000	0	0	2245

Major/Minor	Minor1	Major1	Major2		
Conflicting Flow All	-	1000	0	0	-
Stage 1	-	-	-	-	-
Stage 2	-	-	-	-	-
Critical Hdwy	-	7.14	-	-	-
Critical Hdwy Stg 1	-	-	-	-	-
Critical Hdwy Stg 2	-	-	-	-	-
Follow-up Hdwy	-	3.92	-	-	-
Pot Cap-1 Maneuver	0	207	-	-	0
Stage 1	0	-	-	-	0
Stage 2	0	-	-	-	0
Platoon blocked, %	-	-	-	-	-
Mov Cap-1 Maneuver	-	207	-	-	-
Mov Cap-2 Maneuver	-	-	-	-	-
Stage 1	-	-	-	-	-
Stage 2	-	-	-	-	-

Approach	WB	NB	SB
HCM Control Delay, s	22.7	0	0
HCM LOS	C		

Minor Lane/Major Mvmt	NBT	NBRWBLn1	SBT
Capacity (veh/h)	-	-	207
HCM Lane V/C Ratio	-	-	0.016
HCM Control Delay (s)	-	-	22.7
HCM Lane LOS	-	-	C
HCM 95th %tile Q(veh)	-	-	0



Pepper Square TIA  
Lanes, Volumes, Timings

Phase 1 - 2026 - Background - PM  
4: Berry Trail & Belt Line

Splits and Phases: 4: Berry Trail & Belt Line

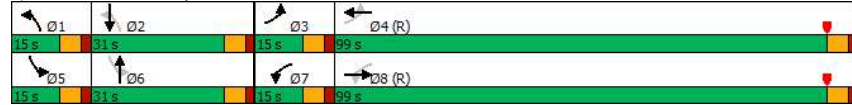

Pepper Square TIA  
Lanes, Volumes, Timings

Phase 1 - 2026 - Background - PM  
1335: Meadow Creek & Belt Line

	EBL	EBT	EBR	WBL	WBT	WBR	NBL	NBT	NBR	SBL	SBT	SBR
Lane Configurations	↑↑↑↑											
Traffic Volume (vph)	88	1336	44	7	1015	18	18	11	9	12	5	60
Future Volume (vph)	88	1336	44	7	1015	18	18	11	9	12	5	60
Ideal Flow (vphpl)	1900	1900	1900	1900	1900	1900	1900	1900	1900	1900	1900	1900
Storage Length (ft)	150		0	150		0	0		0	0		0
Storage Lanes	1		0	1		0	0		0	0		0
Taper Length (ft)	25			25			25			25		
Lane Util. Factor	1.00	0.91	0.91	1.00	0.91	0.91	1.00	1.00	1.00	1.00	1.00	1.00
Frt		0.995			0.997			0.970				0.895
Fit Protected	0.950			0.950				0.977				0.992
Satd. Flow (prot)	1770	5060	0	1770	5070	0	0	1765	0	0	1654	0
Fit Permitted	0.249			0.167				0.528				0.945
Satd. Flow (perm)	464	5060	0	311	5070	0	0	954	0	0	1575	0
Right Turn on Red			Yes			Yes			Yes			Yes
Satd. Flow (RTOR)		6			3			9				63
Link Speed (mph)	42			42			30					30
Link Distance (ft)		1673			2404			392				423
Travel Time (s)		27.2			39.0			8.9				9.6
Peak Hour Factor	0.95	0.95	0.95	0.95	0.95	0.95	0.95	0.95	0.95	0.95	0.95	0.95
Adj. Flow (vph)	93	1406	46	7	1068	19	19	12	9	13	5	63
Shared Lane Traffic (%)												
Lane Group Flow (vph)	93	1452	0	7	1087	0	0	40	0	0	81	0
Enter Blocked Intersection	No	No	No	No	No	No	No	No	No	No	No	No
Lane Alignment	Left	Left	Right	Left	Left	Right	Left	Left	Right	Left	Left	Right
Median Width(ft)	12			12			0			0		0
Link Offset(ft)	0			0			0			0		0
Crosswalk Width(ft)	16			16			16			16		16
Two way Left Turn Lane												
Headway Factor	1.00	1.00	1.00	1.00	1.00	1.00	1.00	1.00	1.00	1.00	1.00	1.00
Turning Speed (mph)	15		9	15		9	15		9	15		9
Number of Detectors	1	1		1	1		1	1		1	1	1
Detector Template												
Leading Detector (ft)	50	50		50	50		50	50		50	50	50
Trailing Detector (ft)	0	0		0	0		0	0		0	0	0
Detector 1 Position(ft)	0	0		0	0		0	0		0	0	0
Detector 1 Size(ft)	50	50		50	50		50	50		50	50	50
Detector 1 Type	Cl+Ex	Cl+Ex		Cl+Ex	Cl+Ex		Cl+Ex	Cl+Ex		Cl+Ex	Cl+Ex	Cl+Ex
Detector 1 Channel												
Detector 1 Extend (s)	0.0	0.0		0.0	0.0		0.0	0.0		0.0	0.0	0.0
Detector 1 Queue (s)	0.0	0.0		0.0	0.0		0.0	0.0		0.0	0.0	0.0
Detector 1 Delay (s)	0.0	0.0		0.0	0.0		0.0	0.0		0.0	0.0	0.0
Turn Type	Perm	NA		Perm	NA		Perm	NA		Perm	NA	NA
Protected Phases		6			2			4			4	4
Permitted Phases	6			2			4			4		4
Detector Phase	6	6		2	2		4	4		4	4	4
Switch Phase												
Minimum Initial (s)	12.0	12.0		12.0	12.0		6.0	6.0		6.0	6.0	6.0
Minimum Split (s)	17.0	17.0		17.0	17.0		23.5	23.5		23.5	23.5	23.5
Total Split (s)	110.0	110.0		110.0	110.0		50.0	50.0		50.0	50.0	50.0



Pepper Square TIA  
Lanes, Volumes, Timings

Phase 1 - 2026 - Background - PM  
1365: Preston & Arapaho

Lane Group	SBL	SBT	SBR
Lane Configurations	↑↑	↑↑↑	
Traffic Volume (vph)	213	1374	183
Future Volume (vph)	213	1374	183
Ideal Flow (vphpl)	1900	1900	1900
Storage Length (ft)	250		0
Storage Lanes	2		0
Taper Length (ft)	25		
Lane Util. Factor	0.97	0.91	0.91
Frt		0.982	
Fit Protected	0.950		
Satd. Flow (prot)	3433	4994	0
Fit Permitted	0.950		
Satd. Flow (perm)	3433	4994	0
Right Turn on Red			Yes
Satd. Flow (RTOR)		18	
Link Speed (mph)		48	
Link Distance (ft)		5087	
Travel Time (s)		72.3	
Peak Hour Factor	0.93	0.93	0.93
Adj. Flow (vph)	229	1477	197
Shared Lane Traffic (%)			
Lane Group Flow (vph)	234	1674	0
Enter Blocked Intersection	No	No	No
Lane Alignment	Left	Left	Right
Median Width(ft)		24	
Link Offset(ft)		0	
Crosswalk Width(ft)		16	
Two way Left Turn Lane			
Headway Factor	1.00	1.00	1.00
Turning Speed (mph)	15		9
Number of Detectors	1	1	
Detector Template			
Leading Detector (ft)	50	50	
Trailing Detector (ft)	0	0	
Detector 1 Position(ft)	0	0	
Detector 1 Size(ft)	50	50	
Detector 1 Type	CI+Ex	CI+Ex	
Detector 1 Channel			
Detector 1 Extend (s)	0.0	0.0	
Detector 1 Queue (s)	0.0	0.0	
Detector 1 Delay (s)	0.0	0.0	
Turn Type	Prot	NA	
Protected Phases	5	2	
Permitted Phases			
Detector Phase	5	2	
Switch Phase			
Minimum Initial (s)	3.0	18.0	
Minimum Split (s)	10.0	37.7	
Total Split (s)	18.0	70.0	

09/22/2022 10:16 am  
Kimley-Horn

Synchro 11 Report  
Page 7

Pepper Square TIA  
Lanes, Volumes, Timings

Phase 1 - 2026 - Background - PM  
1365: Preston & Arapaho

Lane Group	EBU	EBL	EBT	EBR	WBL	WBT	WBR	NBU	NBL	NBT	NBR	SBU
Total Split (%)	18.8%	18.8%	33.1%		8.1%	22.5%		15.0%	15.0%	47.5%		11.3%
Maximum Green (s)	24.5	24.5	47.7		7.5	30.7		18.5	18.5	70.3		12.5
Yellow Time (s)	3.0	3.0	4.3		3.0	4.3		3.0	3.0	4.7		3.0
All-Red Time (s)	2.5	2.5	1.0		2.5	1.0		2.5	2.5	1.0		2.5
Lost Time Adjust (s)		-1.0	-1.4		-1.0	-1.0			-1.0	-1.7		
Total Lost Time (s)		4.5	3.9		4.5	4.3			4.5	4.0		
Lead/Lag	Lead	Lead	Lead		Lag	Lag		Lead	Lead	Lead		Lag
Lead-Lag Optimize?	Yes	Yes	Yes		Yes	Yes		Yes	Yes	Yes		Yes
Vehicle Extension (s)	0.8	0.8	2.5		0.8	1.8		1.5	1.5	1.7		1.5
Recall Mode	None	None	Max		None	None		None	None	Max		None
Walk Time (s)			4.0			4.0				4.0		
Flash Dont Walk (s)			27.0			27.0				26.0		
Pedestrian Calls (#/hr)			0			0				0		
Act Effect Green (s)		17.9	49.1		8.5	39.3			14.6	72.0		
Actuated g/C Ratio		0.11	0.31		0.05	0.25			0.09	0.45		
v/c Ratio		0.76	0.79		0.98	0.64			0.67	0.94		
Control Delay		81.2	53.2		126.5	49.6			97.2	26.3		
Queue Delay		0.0	0.0		0.0	0.0			0.0	0.0		
Total Delay		81.2	53.2		126.5	49.6			97.2	26.3		
LOS		F	D		F	D			F	C		
Approach Delay			58.6			63.8				32.6		
Approach LOS			E			E				C		
Queue Length 50th (ft)			155		97	237			101	182		
Queue Length 95th (ft)			203		#182	269			m118	m200		
Internal Link Dist (ft)			1592			1862				2974		
Turn Bay Length (ft)		150			150				300			
Base Capacity (vph)		547	1539		182	1237			418	2260		
Starvation Cap Reductn		0	0		0	0			0	0		
Spillback Cap Reductn		0	0		0	0			0	0		
Storage Cap Reductn		0	0		0	0			0	0		
Reduced v/c Ratio		0.54	0.79		0.98	0.64			0.50	0.94		

Intersection Summary

Area Type: Other  
 Cycle Length: 160  
 Actuated Cycle Length: 160  
 Offset: 120 (75%), Referenced to phase 2:SBT, Start of Yellow  
 Natural Cycle: 130  
 Control Type: Actuated-Coordinated  
 Maximum v/c Ratio: 0.98  
 Intersection Signal Delay: 45.0  
 Intersection LOS: D  
 Intersection Capacity Utilization 86.1%  
 ICU Level of Service E  
 Analysis Period (min) 15  
 # 95th percentile volume exceeds capacity, queue may be longer.  
 Queue shown is maximum after two cycles.  
 m Volume for 95th percentile queue is metered by upstream signal.

Splits and Phases: 1365: Preston & Arapaho

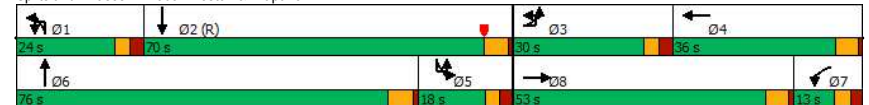

Pepper Square TIA  
Lanes, Volumes, Timings

Phase 1 - 2026 - Background - PM  
1365: Preston & Arapaho

Lane Group	SBL	SBT	SBR
Total Split (%)	11.3%	43.8%	
Maximum Green (s)	12.5	64.3	
Yellow Time (s)	3.0	4.7	
All-Red Time (s)	2.5	1.0	
Lost Time Adjust (s)	-1.0	-1.7	
Total Lost Time (s)	4.5	4.0	
Lead/Lag	Lag	Lag	
Lead-Lag Optimize?	Yes	Yes	
Vehicle Extension (s)	1.5	1.5	
Recall Mode	None	C-Max	
Walk Time (s)		4.0	
Flash Dont Walk (s)		28.0	
Pedestrian Calls (#/hr)		0	
Act Effect Green (s)	13.5	70.9	
Actuated g/C Ratio	0.08	0.44	
v/c Ratio	0.81	0.75	
Control Delay	79.5	34.2	
Queue Delay	0.0	0.0	
Total Delay	79.5	34.2	
LOS	E	C	
Approach Delay		39.8	
Approach LOS		D	
Queue Length 50th (ft)	126	536	
Queue Length 95th (ft)	m152	592	
Internal Link Dist (ft)		5007	
Turn Bay Length (ft)	250		
Base Capacity (vph)	289	2224	
Starvation Cap Reductn	0	0	
Spillback Cap Reductn	0	0	
Storage Cap Reductn	0	0	
Reduced v/c Ratio	0.81	0.75	

Intersection Summary

Pepper Square TIA  
Lanes, Volumes, Timings

Phase 1 - 2026 - Background - PM  
1367: Preston & Belt Line

Lane Group	EBU	EBL	EBT	EBR	WBU	WBL	WBT	WBR	NBL	NBT	NBR	SBU
Lane Configurations		↔↔	↕↕↕	↔		↔	↕↕↕	↔	↔↔	↕↕↕	↔	
Traffic Volume (vph)	45	351	1000	366	1	91	640	105	469	1847	62	2
Future Volume (vph)	45	351	1000	366	1	91	640	105	469	1847	62	2
Ideal Flow (vphpl)	1900	1900	1900	1900	1900	1900	1900	1900	1900	1900	1900	1900
Storage Length (ft)		150		150		200		0	250		0	
Storage Lanes		2		1		1		0	2		0	
Taper Length (ft)		25				25			25			
Lane Util. Factor	0.91	0.97	0.91	1.00	0.91	1.00	0.91	0.91	0.97	0.91	0.91	0.91
Fit			0.850				0.979		0.995			
Fit Protected		0.950				0.950			0.950			
Satd. Flow (prot)	0	3433	5085	1583	0	1770	4979	0	3433	5060	0	0
Fit Permitted		0.950				0.950			0.950			
Satd. Flow (perm)	0	3433	5085	1583	0	1770	4979	0	3433	5060	0	0
Right Turn on Red				Yes			Yes			Yes		Yes
Satd. Flow (RTOR)				220			16			4		
Link Speed (mph)			42				42			42		
Link Distance (ft)			925				394			261		
Travel Time (s)			15.0				6.4			4.2		
Peak Hour Factor	0.96	0.96	0.96	0.96	0.96	0.96	0.96	0.96	0.96	0.96	0.96	0.96
Adj. Flow (vph)	47	366	1042	381	1	95	667	109	489	1924	65	2
Shared Lane Traffic (%)												
Lane Group Flow (vph)	0	413	1042	381	0	96	776	0	489	1989	0	0
Enter Blocked Intersection	No	No	No	No	No	No	No	No	No	No	No	No
Lane Alignment	R NA	Left	Left	Right	R NA	Left	Left	Right	Left	Left	Right	R NA
Median Width(ft)			24				24			24		
Link Offset(ft)			0				0			0		
Crosswalk Width(ft)			16				16			16		
Two way Left Turn Lane												
Headway Factor	1.00	1.00	1.00	1.00	1.00	1.00	1.00	1.00	1.00	1.00	1.00	1.00
Turning Speed (mph)	9	15		9	9	15		9	15		9	9
Number of Detectors	1	1	1	1	1	1	1	1	1	1	1	1
Detector Template												
Leading Detector (ft)	50	50	50	50	50	50	50		50	50		50
Trailing Detector (ft)	0	0	0	0	0	0	0		0	0		0
Detector 1 Position(ft)	0	0	0	0	0	0	0		0	0		0
Detector 1 Size(ft)	50	50	50	50	50	50	50		50	50		50
Detector 1 Type	CI+Ex	CI+Ex	CI+Ex	CI+Ex	CI+Ex	CI+Ex	CI+Ex		CI+Ex	CI+Ex		CI+Ex
Detector 1 Channel												
Detector 1 Extend (s)	0.0	0.0	0.0	0.0	0.0	0.0	0.0		0.0	0.0		0.0
Detector 1 Queue (s)	0.0	0.0	0.0	0.0	0.0	0.0	0.0		0.0	0.0		0.0
Detector 1 Delay (s)	0.0	0.0	0.0	0.0	0.0	0.0	0.0		0.0	0.0		0.0
Turn Type	Prot	Prot	NA	Perm	Prot	Prot	NA		Prot	NA		Prot
Permitted Phases	3 13	3 13	8		17	17	4		1 11	6		5
Detector Phase	3 13	3 13	8	8	17	17	4		1 11	6		5
Switch Phase												
Minimum Initial (s)			18.0	18.0	3.0	3.0	18.0			18.0		3.0
Minimum Split (s)			32.5	32.5	8.0	8.0	32.5			33.0		11.0
Total Split (s)			50.0	50.0	14.0	14.0	27.0			77.0		19.0

Pepper Square TIA  
Lanes, Volumes, Timings

Phase 1 - 2026 - Background - PM  
1367: Preston & Belt Line

Lane Group	SBL	SBT	SBR	Ø1	Ø3	Ø11	Ø13
Lane Configurations							
Traffic Volume (vph)	138	1382	256				
Future Volume (vph)	138	1382	256				
Ideal Flow (vphpl)	1900	1900	1900				
Storage Length (ft)	200		300				
Storage Lanes	1		1				
Taper Length (ft)	25						
Lane Util. Factor	1.00	0.91	1.00				
Frnt			0.850				
Fit Protected	0.950						
Satd. Flow (prot)	1770	5085	1583				
Fit Permitted	0.950						
Satd. Flow (perm)	1770	5085	1583				
Right Turn on Red			Yes				
Satd. Flow (RTOR)			227				
Link Speed (mph)		40					
Link Distance (ft)		3054					
Travel Time (s)		52.1					
Peak Hour Factor	0.96	0.96	0.96				
Adj. Flow (vph)	144	1440	267				
Shared Lane Traffic (%)							
Lane Group Flow (vph)	146	1440	267				
Enter Blocked Intersection	No	No	No				
Lane Alignment	Left	Left	Right				
Median Width(ft)		24					
Link Offset(ft)		0					
Crosswalk Width(ft)		16					
Two way Left Turn Lane							
Headway Factor	1.00	1.00	1.00				
Turning Speed (mph)	15		9				
Number of Detectors	1	1	1				
Detector Template							
Leading Detector (ft)	50	50	50				
Trailing Detector (ft)	0	0	0				
Detector 1 Position(ft)	0	0	0				
Detector 1 Size(ft)	50	50	50				
Detector 1 Type	CI+Ex	CI+Ex	CI+Ex				
Detector 1 Channel							
Detector 1 Extend (s)	0.0	0.0	0.0				
Detector 1 Queue (s)	0.0	0.0	0.0				
Detector 1 Delay (s)	0.0	0.0	0.0				
Turn Type	Prot	NA	Perm				
Protected Phases	5	2		1	3	11	13
Permitted Phases			2				
Detector Phase	5	2	2				
Switch Phase							
Minimum Initial (s)	3.0	18.0	18.0	3.0	3.0	3.0	3.0
Minimum Split (s)	11.0	33.0	33.0	8.0	11.0	8.0	11.0
Total Split (s)	19.0	60.0	60.0	16.0	20.0	20.0	17.0

Pepper Square TIA  
Lanes, Volumes, Timings

Phase 1 - 2026 - Background - PM  
1367: Preston & Belt Line

Lane Group	EBU	EBL	EBT	EBR	WBU	WBL	WBT	WBR	NBL	NBT	NBR	SBU
Total Split (%)			31.3%	31.3%	8.8%	8.8%	16.9%			48.1%		11.9%
Maximum Green (s)			44.5	44.5	9.0	9.0	21.5			71.0		14.0
Yellow Time (s)			4.0	4.0	3.0	3.0	4.0			4.4		3.0
All-Red Time (s)			1.5	1.5	2.0	2.0	1.5			1.6		2.0
Lost Time Adjust (s)			-1.5	-1.5		-1.0	-1.5			-1.7		
Total Lost Time (s)			4.0	4.0		4.0	4.0			4.3		
Lead/Lag									Lag	Lag		Lead
Lead-Lag Optimize?									Yes	Yes		Yes
Vehicle Extension (s)			1.3	1.3	3.0	3.0	1.3			2.0		1.5
Recall Mode			Min	Min	None	None	Min			C-Max		None
Walk Time (s)			7.0	7.0			7.0			7.0		
Flash Dont Walk (s)			20.0	20.0			20.0			20.0		
Pedestrian Calls (/hr)			0	0			0			0		
Act Effect Green (s)			27.3	39.0	39.0		15.7	23.3		31.6		73.8
Actuated g/C Ratio			0.17	0.24	0.24		0.10	0.15		0.20		0.46
v/c Ratio			0.70	0.84	0.69		0.55	1.05		0.72		0.85
Control Delay			58.5	68.8	36.2		57.0	75.2		43.9		21.4
Queue Delay			0.0	0.0	0.0		0.0	0.0		0.0		0.9
Total Delay			58.5	68.8	36.2		57.0	75.2		43.9		22.3
LOS			E	E	D		E	E		D		C
Approach Delay				59.7				73.2				26.6
Approach LOS				E				E				C
Queue Length 50th (ft)			174	401	184		105	~308		202		648
Queue Length 95th (ft)			245	444	324		#216	#403		269		605
Internal Link Dist (ft)				845				314				181
Turn Bay Length (ft)			150		150		200			250		
Base Capacity (vph)			622	1461	611		173	740		677		2335
Starvation Cap Reductn			0	0	0		0	0		0		139
Spillback Cap Reductn			0	0	0		0	0		0		0
Storage Cap Reductn			0	0	0		0	0		0		0
Reduced v/c Ratio			0.66	0.71	0.62		0.55	1.05		0.72		0.91
<b>Intersection Summary</b>												
Area Type:	Other											
Cycle Length:	160											
Actuated Cycle Length:	160											
Offset:	56 (35%), Referenced to phase 6:NBT, Start of Yellow											
Natural Cycle:	115											
Control Type:	Actuated-Coordinated											
Maximum v/c Ratio:	1.05											
Intersection Signal Delay:	45.3											
Intersection Capacity Utilization:	84.7%											
Intersection LOS:	D											
ICU Level of Service:	E											
Analysis Period (min):	15											
~	Volume exceeds capacity, queue is theoretically infinite. Queue shown is maximum after two cycles.											
#	95th percentile volume exceeds capacity, queue may be longer. Queue shown is maximum after two cycles.											
m	Volume for 95th percentile queue is metered by upstream signal.											



Pepper Square TIA  
Lanes, Volumes, Timings

Phase 1 - 2026 - Background - PM  
1367: Preston & Belt Line

Splits and Phases: 1367: Preston & Belt Line

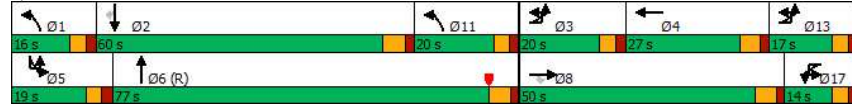

Pepper Square TIA  
Lanes, Volumes, Timings

Phase 1 - 2026 - Background - PM  
1367: Preston & Belt Line

Lane Group	SBL	SBT	SBR	Ø1	Ø3	Ø11	Ø13
Total Split (%)	11.9%	37.5%	37.5%	10%	13%	13%	11%
Maximum Green (s)	14.0	54.0	54.0	11.0	15.0	15.0	12.0
Yellow Time (s)	3.0	4.4	4.4	3.0	3.0	3.0	3.0
All-Red Time (s)	2.0	1.6	1.6	2.0	2.0	2.0	2.0
Lost Time Adjust (s)	-1.0	-1.7	-1.7				
Total Lost Time (s)	4.0	4.3	4.3				
Lead/Lag	Lead	Lag	Lag	Lead	Lead		
Lead-Lag Optimize?	Yes	Yes	Yes	Yes	Yes		
Vehicle Extension (s)	1.5	2.5	2.5	1.6	1.3	3.0	3.0
Recall Mode	None	Ped	Ped	None	None	None	None
Walk Time (s)		7.0	7.0				
Flash Dont Walk (s)		20.0	20.0				
Pedestrian Calls (#/hr)		0	0				
Act Effect Green (s)	15.3	53.5	53.5				
Actuated g/C Ratio	0.10	0.33	0.33				
v/c Ratio	0.87	0.85	0.39				
Control Delay	85.5	44.5	11.1				
Queue Delay	0.0	0.0	0.0				
Total Delay	85.5	44.5	11.1				
LOS	F	D	B				
Approach Delay		42.9					
Approach LOS		D					
Queue Length 50th (ft)	137	556	138				
Queue Length 95th (ft)	m#221	m609	m163				
Internal Link Dist (ft)		2974					
Turn Bay Length (ft)	200		300				
Base Capacity (vph)	171	1770	699				
Starvation Cap Reductn	0	0	0				
Spillback Cap Reductn	0	0	0				
Storage Cap Reductn	0	0	0				
Reduced v/c Ratio	0.85	0.81	0.38				
<b>Intersection Summary</b>							

Pepper Square TIA  
Lanes, Volumes, Timings

Phase 1 - 2026 - Background - PM  
1368: Preston & Alexis

Lane Group	EBL	EBT	EBR	WBL	WBT	WBR	NBU	NBL	NBT	NBR	SBL	SBT
Lane Configurations	↔	↔	↔	↔	↔	↔	↔	↔	↔	↔	↔	↔
Traffic Volume (vph)	66	24	64	223	24	74	7	43	2272	236	149	1607
Future Volume (vph)	66	24	64	223	24	74	7	43	2272	236	149	1607
Ideal Flow (vphpl)	1900	1900	1900	1900	1900	1900	1900	1900	1900	1900	1900	1900
Storage Length (ft)	0	0	175		0		150		150		150	
Storage Lanes	1	1	2		1		1		1		1	
Taper Length (ft)	25		25				25				25	
Lane Util. Factor	0.91	0.91	1.00	0.97	1.00	1.00	0.91	1.00	0.91	1.00	1.00	0.91
Frt			0.850			0.850					0.850	
Fit Protected	0.950	0.972		0.950				0.950			0.950	
Satd. Flow (prot)	1610	3295	1583	3433	1863	1583	0	1770	5085	1583	1770	5085
Fit Permitted	0.950	0.972		0.950				0.109			0.040	
Satd. Flow (perm)	1610	3295	1583	3433	1863	1583	0	203	5085	1583	75	5085
Right Turn on Red			Yes			Yes				Yes		
Satd. Flow (RTOR)			125			85				100		
Link Speed (mph)	30			30					43			42
Link Distance (ft)	660			627					2867			173
Travel Time (s)	15.0			14.3					45.5			2.8
Peak Hour Factor	0.95	0.95	0.95	0.95	0.95	0.95	0.95	0.95	0.95	0.95	0.95	0.95
Adj. Flow (vph)	69	25	67	235	25	78	7	45	2392	248	157	1692
Shared Lane Traffic (%)	50%											
Lane Group Flow (vph)	34	60	67	235	25	78	0	52	2392	248	157	1692
Enter Blocked Intersection	No	No	No	No	No	No	No	No	No	No	No	No
Lane Alignment	Left	Left	Right	Left	Left	Right	R NA	Left	Left	Right	Left	Left
Median Width(ft)	24			24					12			12
Link Offset(ft)	0			0					0			0
Crosswalk Width(ft)	16			16					16			16
Two way Left Turn Lane												
Headway Factor	1.00	1.00	1.00	1.00	1.00	1.00	1.00	1.00	1.00	1.00	1.00	1.00
Turning Speed (mph)	15		9	15		9	9	15		9	15	
Number of Detectors	1	1	1	1	1	1	1	1	1	1	1	1
Detector Template												
Leading Detector (ft)	50	50	50	50	50	50	50	50	50	50	50	50
Trailing Detector (ft)	0	0	0	0	0	0	0	0	0	0	0	0
Detector 1 Position(ft)	0	0	0	0	0	0	0	0	0	0	0	0
Detector 1 Size(ft)	50	50	50	50	50	50	50	50	50	50	50	50
Detector 1 Type	Cl+Ex	Cl+Ex	Cl+Ex	Cl+Ex	Cl+Ex	Cl+Ex	Cl+Ex	Cl+Ex	Cl+Ex	Cl+Ex	Cl+Ex	Cl+Ex
Detector 1 Channel												
Detector 1 Extend (s)	0.0	0.0	0.0	0.0	0.0	0.0	0.0	0.0	0.0	0.0	0.0	0.0
Detector 1 Queue (s)	0.0	0.0	0.0	0.0	0.0	0.0	0.0	0.0	0.0	0.0	0.0	0.0
Detector 1 Delay (s)	0.0	0.0	0.0	0.0	0.0	0.0	0.0	0.0	0.0	0.0	0.0	0.0
Turn Type	Split	NA	Perm	Split	NA	pm+ov	D.P+P	D.P+P	NA	Perm	D.P+P	NA
Protected Phases	3	3		4	4	5	1	1	6		5	2
Permitted Phases			3			4	2	2		6	6	
Detector Phase	3	3	3	4	4	5	1	1	6	6	5	2
Switch Phase												
Minimum Initial (s)	6.0	6.0	6.0	8.0	8.0	3.0	3.0	3.0	14.0	14.0	3.0	14.0
Minimum Split (s)	27.0	27.0	27.0	27.0	27.0	8.4	8.4	8.4	24.0	24.0	8.4	24.0
Total Split (s)	23.0	23.0	23.0	22.0	22.0	20.0	15.0	15.0	95.0	95.0	20.0	100.0

Pepper Square TIA  
Lanes, Volumes, Timings

Phase 1 - 2026 - Background - PM  
1368: Preston & Alexis

Lane Group	SBR
Lane Configurations	↔
Traffic Volume (vph)	23
Future Volume (vph)	23
Ideal Flow (vphpl)	1900
Storage Length (ft)	150
Storage Lanes	1
Taper Length (ft)	
Lane Util. Factor	1.00
Frt	0.850
Fit Protected	
Satd. Flow (prot)	1583
Fit Permitted	
Satd. Flow (perm)	1583
Right Turn on Red	Yes
Satd. Flow (RTOR)	78
Link Speed (mph)	
Link Distance (ft)	
Travel Time (s)	
Peak Hour Factor	0.95
Adj. Flow (vph)	24
Shared Lane Traffic (%)	
Lane Group Flow (vph)	24
Enter Blocked Intersection	No
Lane Alignment	Right
Median Width(ft)	
Link Offset(ft)	
Crosswalk Width(ft)	
Two way Left Turn Lane	
Headway Factor	1.00
Turning Speed (mph)	9
Number of Detectors	1
Detector Template	
Leading Detector (ft)	50
Trailing Detector (ft)	0
Detector 1 Position(ft)	0
Detector 1 Size(ft)	50
Detector 1 Type	Cl+Ex
Detector 1 Channel	
Detector 1 Extend (s)	0.0
Detector 1 Queue (s)	0.0
Detector 1 Delay (s)	0.0
Turn Type	Perm
Protected Phases	
Permitted Phases	2
Detector Phase	2
Switch Phase	
Minimum Initial (s)	14.0
Minimum Split (s)	24.0
Total Split (s)	100.0

Pepper Square TIA  
Lanes, Volumes, Timings

Phase 1 - 2026 - Background - PM  
1368: Preston & Alexis

Lane Group	EBL	EBT	EBR	WBL	WBT	WBR	NBU	NBL	NBT	NBR	SBL	SBT
Total Split (%)	14.4%	14.4%	14.4%	13.8%	13.8%	12.5%	9.4%	9.4%	59.4%	59.4%	12.5%	62.5%
Maximum Green (s)	18.0	18.0	18.0	17.0	17.0	15.6	10.6	10.6	89.0	89.0	15.6	94.0
Yellow Time (s)	4.0	4.0	4.0	4.0	4.0	3.4	3.4	3.4	4.5	4.5	3.4	4.5
All-Red Time (s)	1.0	1.0	1.0	1.0	1.0	1.0	1.0	1.0	1.5	1.5	1.0	1.5
Lost Time Adjust (s)	-1.0	-1.0	0.0	-1.0	-1.0	0.0			-1.0	-2.0	0.0	-2.0
Total Lost Time (s)	4.0	4.0	5.0	4.0	4.0	4.4			3.4	4.0	6.0	3.4
Lead/Lag	Lag	Lag	Lag	Lead	Lead	Lag	Lead	Lead	Lead	Lead	Lag	Lag
Lead-Lag Optimize?	Yes	Yes	Yes	Yes	Yes	Yes	Yes	Yes	Yes	Yes	Yes	Yes
Vehicle Extension (s)	2.0	2.0	2.0	2.0	2.0	1.2	1.2	1.2	2.5	2.5	1.2	2.5
Recall Mode	None	None	None	None	None	None	None	None	Max	Max	None	C-Max
Walk Time (s)	4.0	4.0	4.0	4.0	4.0				4.0	4.0		4.0
Flash Dont Walk (s)	18.0	18.0	18.0	18.0	18.0				14.0	14.0		14.0
Pedestrian Calls (#/hr)	0	0	0	0	0				0	0		0
Act Effect Green (s)	9.1	9.1	8.1	15.8	15.8	35.4			121.0	103.1	101.1	120.3
Actuated g/C Ratio	0.06	0.06	0.05	0.10	0.10	0.22			0.76	0.64	0.63	0.75
v/c Ratio	0.37	0.32	0.34	0.70	0.14	0.19			0.25	0.73	0.24	0.68
Control Delay	83.4	76.3	4.5	80.8	66.5	8.6			7.3	17.4	6.2	38.8
Queue Delay	0.0	0.0	0.0	0.0	0.0	0.0			0.0	0.0	0.0	0.0
Total Delay	83.4	76.3	4.5	80.8	66.5	8.6			7.3	17.4	6.2	38.8
LOS	F	E	A	F	E	A			A	B	A	D
Approach Delay		47.9			63.1				16.2			6.1
Approach LOS		D			E				B			A
Queue Length 50th (ft)	38	34	0	124	24	0			10	484	40	114
Queue Length 95th (ft)	80	60	0	171	57	39			20	672	69	#200
Internal Link Dist (ft)		580			547				2787			93
Turn Bay Length (ft)				175					150		150	
Base Capacity (vph)	191	391	289	386	209	416			270	3276	1036	232
Starvation Cap Reductn	0	0	0	0	0	0			0	0	0	0
Spillback Cap Reductn	0	0	0	0	0	0			0	0	0	0
Storage Cap Reductn	0	0	0	0	0	0			0	0	0	0
Reduced v/c Ratio	0.18	0.15	0.23	0.61	0.12	0.19			0.19	0.73	0.24	0.68

Intersection Summary

Area Type: Other  
 Cycle Length: 160  
 Actuated Cycle Length: 160  
 Offset: 63 (39%), Referenced to phase 2:NBSB, Start of Yellow  
 Natural Cycle: 130  
 Control Type: Actuated-Coordinated  
 Maximum v/c Ratio: 0.73  
 Intersection Signal Delay: 16.6 Intersection LOS: B  
 Intersection Capacity Utilization 75.2% ICU Level of Service D  
 Analysis Period (min) 15  
 # 95th percentile volume exceeds capacity, queue may be longer.  
 Queue shown is maximum after two cycles.  
 m Volume for 95th percentile queue is metered by upstream signal.

Splits and Phases: 1368: Preston & Alexis

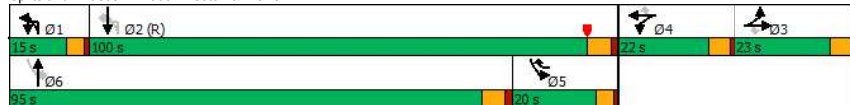

Pepper Square TIA  
Lanes, Volumes, Timings

Phase 1 - 2026 - Background - PM  
1368: Preston & Alexis

Lane Group	SBR
Total Split (%)	62.5%
Maximum Green (s)	94.0
Yellow Time (s)	4.5
All-Red Time (s)	1.5
Lost Time Adjust (s)	0.0
Total Lost Time (s)	6.0
Lead/Lag	Lag
Lead-Lag Optimize?	Yes
Vehicle Extension (s)	2.5
Recall Mode	C-Max
Walk Time (s)	4.0
Flash Dont Walk (s)	14.0
Pedestrian Calls (#/hr)	0
Act Effect Green (s)	113.5
Actuated g/C Ratio	0.71
v/c Ratio	0.02
Control Delay	0.0
Queue Delay	0.0
Total Delay	0.0
LOS	A
Approach Delay	
Approach LOS	
Queue Length 50th (ft)	0
Queue Length 95th (ft)	m0
Internal Link Dist (ft)	
Turn Bay Length (ft)	150
Base Capacity (vph)	1145
Starvation Cap Reductn	0
Spillback Cap Reductn	0
Storage Cap Reductn	0
Reduced v/c Ratio	0.02

Intersection Summary

Area Type: Other  
 Cycle Length: 160  
 Actuated Cycle Length: 160  
 Offset: 63 (39%), Referenced to phase 2:NBSB, Start of Yellow  
 Natural Cycle: 130  
 Control Type: Actuated-Coordinated  
 Maximum v/c Ratio: 0.73  
 Intersection Signal Delay: 16.6 Intersection LOS: B  
 Intersection Capacity Utilization 75.2% ICU Level of Service D  
 Analysis Period (min) 15  
 # 95th percentile volume exceeds capacity, queue may be longer.  
 Queue shown is maximum after two cycles.  
 m Volume for 95th percentile queue is metered by upstream signal.

Pepper Square TIA  
Lanes, Volumes, Timings

Phase 1 - 2026 - Background - PM  
1369: Preston & Belt Line Village Driveway



Lane Group	EBL	EBT	EBR	WBL	WBT	WBR	NBU	NBL	NBT	NBR	SBU	SBL
Lane Configurations		↑↑			↑↑			↑↑	↑↑↑			↑
Traffic Volume (vph)	79	5	53	25	6	18	1	67	2213	12	8	57
Future Volume (vph)	79	5	53	25	6	18	1	67	2213	12	8	57
Ideal Flow (vphpl)	1900	1900	1900	1900	1900	1900	1900	1900	1900	1900	1900	1900
Storage Length (ft)	0	0	0	0	0	0	0	100	0	0	0	100
Storage Lanes	0	0	0	0	0	0	0	1	0	0	0	1
Taper Length (ft)	25			25				25				25
Lane Util. Factor	0.95	0.95	0.95	1.00	1.00	1.00	0.91	1.00	0.91	0.91	0.91	1.00
Frt		0.941			0.950			0.999				
Fit Protected		0.972			0.975			0.950				0.950
Satd. Flow (prot)	0	3237	0	0	1725	0	0	1770	5080	0	0	1770
Fit Permitted		0.763			0.809			0.083				0.049
Satd. Flow (perm)	0	2541	0	0	1432	0	0	155	5080	0	0	91
Right Turn on Red			Yes			Yes				Yes		
Satd. Flow (RTOR)		55			18				1			
Link Speed (mph)		30			30				42			
Link Distance (ft)		303			249				252			
Travel Time (s)		6.9			5.7				4.1			
Peak Hour Factor	0.97	0.97	0.97	0.97	0.97	0.97	0.97	0.97	0.97	0.97	0.97	0.97
Adj. Flow (vph)	81	5	55	26	6	19	1	69	2281	12	8	59
Shared Lane Traffic (%)												
Lane Group Flow (vph)	0	141	0	0	51	0	0	70	2293	0	0	67
Enter Blocked Intersection	No	No	No	No	No	No	No	No	No	No	No	No
Lane Alignment	Left	Left	Right	Left	Left	Right	R NA	Left	Left	Right	R NA	Left
Median Width(ft)		0			0				12			
Link Offset(ft)		0			0				0			
Crosswalk Width(ft)		16			16				16			
Two way Left Turn Lane												
Headway Factor	1.00	1.00	1.00	1.00	1.00	1.00	1.00	1.00	1.00	1.00	1.00	1.00
Turning Speed (mph)	15		9	15		9	9	15		9	9	15
Number of Detectors	1	1		1	1		1	1	1		1	1
Detector Template												
Leading Detector (ft)	50	50		50	50		50	50	50		50	50
Trailing Detector (ft)	0	0		0	0		0	0	0		0	0
Detector 1 Position(ft)	0	0		0	0		0	0	0		0	0
Detector 1 Size(ft)	50	50		50	50		50	50	50		50	50
Detector 1 Type	Cl+Ex	Cl+Ex		Cl+Ex	Cl+Ex		Cl+Ex	Cl+Ex	Cl+Ex		Cl+Ex	Cl+Ex
Detector 1 Channel												
Detector 1 Extend (s)	0.0	0.0		0.0	0.0		0.0	0.0	0.0		0.0	0.0
Detector 1 Queue (s)	0.0	0.0		0.0	0.0		0.0	0.0	0.0		0.0	0.0
Detector 1 Delay (s)	0.0	0.0		0.0	0.0		0.0	0.0	0.0		0.0	0.0
Turn Type	Perm	NA		Perm	NA		custom	D.P+P	NA		custom	D.P+P
Protected Phases		8			4			1	2			5
Permitted Phases	8			4			1	2			5	6
Detector Phase	8	8		4	4		1	1	6		5	5
Switch Phase												
Minimum Initial (s)	20.0	20.0		20.0	20.0		5.0	5.0	20.0		5.0	5.0
Minimum Split (s)	25.0	25.0		25.0	25.0		10.0	10.0	26.0		10.0	10.0
Total Split (s)	47.0	47.0		47.0	47.0		20.0	20.0	98.0		15.0	15.0

Pepper Square TIA  
Lanes, Volumes, Timings

Phase 1 - 2026 - Background - PM  
1369: Preston & Belt Line Village Driveway



Lane Group	SBT	SBR
Lane Configurations	↑↑↑	
Traffic Volume (vph)	1849	26
Future Volume (vph)	1849	26
Ideal Flow (vphpl)	1900	1900
Storage Length (ft)	0	0
Storage Lanes	0	0
Taper Length (ft)		
Lane Util. Factor	0.91	0.91
Frt	0.998	
Fit Protected		
Satd. Flow (prot)	5075	0
Fit Permitted		
Satd. Flow (perm)	5075	0
Right Turn on Red		Yes
Satd. Flow (RTOR)	2	
Link Speed (mph)	38	
Link Distance (ft)	191	
Travel Time (s)	3.4	
Peak Hour Factor	0.97	0.97
Adj. Flow (vph)	1906	27
Shared Lane Traffic (%)		
Lane Group Flow (vph)	1933	0
Enter Blocked Intersection	No	No
Lane Alignment	Left	Right
Median Width(ft)	12	
Link Offset(ft)	0	
Crosswalk Width(ft)	16	
Two way Left Turn Lane		
Headway Factor	1.00	1.00
Turning Speed (mph)		9
Number of Detectors	1	
Detector Template		
Leading Detector (ft)	50	
Trailing Detector (ft)	0	
Detector 1 Position(ft)	0	
Detector 1 Size(ft)	50	
Detector 1 Type	Cl+Ex	
Detector 1 Channel		
Detector 1 Extend (s)	0.0	
Detector 1 Queue (s)	0.0	
Detector 1 Delay (s)	0.0	
Turn Type	NA	
Protected Phases	2	
Permitted Phases		
Detector Phase	2	
Switch Phase		
Minimum Initial (s)	20.0	
Minimum Split (s)	26.0	
Total Split (s)	93.0	

Pepper Square TIA  
Lanes, Volumes, Timings

Phase 1 - 2026 - Background - PM  
1369: Preston & Belt Line Village Driveway



Lane Group	EBL	EBT	EBR	WBL	WBT	WBR	NBU	NBL	NBT	NBR	SBU	SBL
Total Split (%)	29.4%	29.4%		29.4%	29.4%		12.5%	12.5%	61.3%		9.4%	9.4%
Maximum Green (s)	42.3	42.3		42.3	42.3		15.0	15.0	93.7		10.0	10.0
Yellow Time (s)	3.0	3.0		3.0	3.0		3.0	3.0	3.0		3.0	3.0
All-Red Time (s)	1.7	1.7		1.7	1.7		2.0	2.0	1.3		2.0	2.0
Lost Time Adjust (s)		-1.0			-1.0			-1.0	-2.0			-1.0
Total Lost Time (s)		3.7			3.7			4.0	2.3			4.0
Lead/Lag							Lead	Lead	Lead		Lag	Lag
Lead-Lag Optimize?							Yes	Yes	Yes		Yes	Yes
Vehicle Extension (s)	2.0	2.0		2.0	2.0		1.5	1.5	3.0		1.5	1.5
Recall Mode	None	None		None	None		None	None	Max		None	None
Walk Time (s)	5.0	5.0		5.0	5.0				7.0			
Flash Dont Walk (s)	15.0	15.0		15.0	15.0				8.0			
Pedestrian Calls (#/hr)	0	0		0	0				0			
Act Effect Green (s)		21.0			21.0		127.3	118.0				127.3
Actuated g/C Ratio		0.13			0.13		0.80	0.74				0.80
v/c Ratio		0.37			0.25		0.35	0.61				0.36
Control Delay		41.4			46.1		11.8	2.2				25.6
Queue Delay		0.0			0.0		0.0	0.2				0.0
Total Delay		41.4			46.1		11.8	2.4				25.6
LOS		D			D		B	A				C
Approach Delay		41.4			46.1			2.6				
Approach LOS		D			D			A				
Queue Length 50th (ft)		43			31		3	42				24
Queue Length 95th (ft)		81			77		m15	43				m39
Internal Link Dist (ft)		223			169			172				
Turn Bay Length (ft)							100					100
Base Capacity (vph)		727			400		288	3746				187
Starvation Cap Reductn		0			0		0	555				0
Spillback Cap Reductn		2			0		0	423				0
Storage Cap Reductn		0			0		0	0				0
Reduced v/c Ratio		0.19			0.13		0.24	0.72				0.36

Intersection Summary

Area Type: Other  
 Cycle Length: 160  
 Actuated Cycle Length: 160  
 Offset: 86 (54%), Referenced to phase 2:NBSB, Start of Yellow  
 Natural Cycle: 70  
 Control Type: Actuated-Coordinated  
 Maximum v/c Ratio: 0.61  
 Intersection Signal Delay: 4.9 Intersection LOS: A  
 Intersection Capacity Utilization 73.9% ICU Level of Service D  
 Analysis Period (min) 15  
 m Volume for 95th percentile queue is metered by upstream signal.

Splits and Phases: 1369: Preston & Belt Line Village Driveway

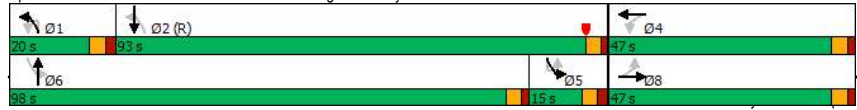

Pepper Square TIA  
Lanes, Volumes, Timings

Phase 1 - 2026 - Background - PM  
1369: Preston & Belt Line Village Driveway



Lane Group	SBT	SBR
Total Split (%)	58.1%	
Maximum Green (s)	88.7	
Yellow Time (s)	3.0	
All-Red Time (s)	1.3	
Lost Time Adjust (s)	-2.0	
Total Lost Time (s)	2.3	
Lead/Lag	Lag	
Lead-Lag Optimize?	Yes	
Vehicle Extension (s)	3.3	
Recall Mode	C-Max	
Walk Time (s)	7.0	
Flash Dont Walk (s)	8.0	
Pedestrian Calls (#/hr)	0	
Act Effect Green (s)	121.6	
Actuated g/C Ratio	0.76	
v/c Ratio	0.50	
Control Delay	3.0	
Queue Delay	0.3	
Total Delay	3.3	
LOS	A	
Approach Delay	4.0	
Approach LOS	A	
Queue Length 50th (ft)	83	
Queue Length 95th (ft)	120	
Internal Link Dist (ft)	111	
Turn Bay Length (ft)		
Base Capacity (vph)	3856	
Starvation Cap Reductn	1043	
Spillback Cap Reductn	0	
Storage Cap Reductn	0	
Reduced v/c Ratio	0.69	

Intersection Summary

Area Type: Other  
 Cycle Length: 160  
 Actuated Cycle Length: 160  
 Offset: 86 (54%), Referenced to phase 2:NBSB, Start of Yellow  
 Natural Cycle: 70  
 Control Type: Actuated-Coordinated  
 Maximum v/c Ratio: 0.61  
 Intersection Signal Delay: 4.9 Intersection LOS: A  
 Intersection Capacity Utilization 73.9% ICU Level of Service D  
 Analysis Period (min) 15  
 m Volume for 95th percentile queue is metered by upstream signal.

Pepper Square TIA  
Lanes, Volumes, Timings

Phase 1 - 2026 - Background - PM  
1371: Preston & Spring Valley

Lane Group	EBL	EBT	EBR	WBL	WBT	WBR	NBU	NBT	NBR	SBU	SBL
Lane Configurations	↑↑	↑↑↑		↑↑	↑↑↑			↑↑	↑↑↑		↑↑
Traffic Volume (vph)	295	779	222	103	479	156	1	189	2176	196	6
Future Volume (vph)	295	779	222	103	479	156	1	189	2176	196	6
Ideal Flow (vphpl)	1900	1900	1900	1900	1900	1900	1900	1900	1900	1900	1900
Storage Length (ft)	225		0	225		0		225		0	275
Storage Lanes	2		0	2		0		2		0	2
Taper Length (ft)	25			25				25			25
Lane Util. Factor	0.97	0.91	0.91	0.97	0.91	0.91	0.91	0.97	0.91	0.91	0.97
Frt		0.967			0.963				0.988		
Fit Protected	0.950			0.950				0.950			0.950
Satd. Flow (prot)	3433	4917	0	3433	4897	0	0	3433	5024	0	3433
Fit Permitted	0.950			0.950				0.950			0.950
Satd. Flow (perm)	3433	4917	0	3433	4897	0	0	3433	5024	0	3433
Right Turn on Red			Yes			Yes				Yes	
Satd. Flow (RTOR)		45			42				13		
Link Speed (mph)	38				42				41		
Link Distance (ft)		3259			5488				2139		
Travel Time (s)		58.5			89.1				35.6		
Peak Hour Factor	0.94	0.94	0.94	0.94	0.94	0.94	0.94	0.94	0.94	0.94	0.94
Adj. Flow (vph)	314	829	236	110	510	166	1	201	2315	209	6
Shared Lane Traffic (%)											
Lane Group Flow (vph)	314	1065	0	110	676	0	0	202	2524	0	169
Enter Blocked Intersection	No	No	No	No	No	No	No	No	No	No	No
Lane Alignment	Left	Left	Right	Left	Left	Right	R NA	Left	Left	Right	R NA
Median Width(ft)		24			24				24		
Link Offset(ft)		0			0				0		
Crosswalk Width(ft)		16			16				16		
Two way Left Turn Lane											
Headway Factor	1.00	1.00	1.00	1.00	1.00	1.00	1.00	1.00	1.00	1.00	1.00
Turning Speed (mph)	15		9	15		9	9	15		9	15
Number of Detectors	1	1		1	1		1	1	1	1	1
Detector Template											
Leading Detector (ft)	50	50		50	50		50	50	50		50
Trailing Detector (ft)	0	0		0	0		0	0	0		0
Detector 1 Position(ft)	0	0		0	0		0	0	0		0
Detector 1 Size(ft)	50	50		50	50		50	50	50		50
Detector 1 Type	Cl+Ex	Cl+Ex		Cl+Ex	Cl+Ex		Cl+Ex	Cl+Ex	Cl+Ex		Cl+Ex
Detector 1 Channel											
Detector 1 Extend (s)	0.0	0.0		0.0	0.0		0.0	0.0	0.0		0.0
Detector 1 Queue (s)	0.0	0.0		0.0	0.0		0.0	0.0	0.0		0.0
Detector 1 Delay (s)	0.0	0.0		0.0	0.0		0.0	0.0	0.0		0.0
Turn Type	Prot	NA		Prot	NA		Prot	Prot	NA		Prot
Protected Phases	3	8		7	4		1	1	6		5
Permitted Phases											
Detector Phase	3	8		7	4		1	1	6		5
Switch Phase											
Minimum Initial (s)	6.0	12.0		3.0	12.0		3.0	3.0	13.0		3.0
Minimum Split (s)	11.0	27.5		11.0	27.5		11.0	11.0	28.0		11.0
Total Split (s)	40.0	50.0		13.0	23.0		22.0	22.0	82.0		15.0

Pepper Square TIA  
Lanes, Volumes, Timings

Phase 1 - 2026 - Background - PM  
1371: Preston & Spring Valley

Lane Group	SBT	SBR
Lane Configurations	↑↑↑	
Traffic Volume (vph)	1542	181
Future Volume (vph)	1542	181
Ideal Flow (vphpl)	1900	1900
Storage Length (ft)		0
Storage Lanes		0
Taper Length (ft)		
Lane Util. Factor	0.91	0.91
Frt	0.984	
Fit Protected		
Satd. Flow (prot)	5004	0
Fit Permitted		
Satd. Flow (perm)	5004	0
Right Turn on Red		Yes
Satd. Flow (RTOR)	16	
Link Speed (mph)	38	
Link Distance (ft)	1208	
Travel Time (s)	21.7	
Peak Hour Factor	0.94	0.94
Adj. Flow (vph)	1640	193
Shared Lane Traffic (%)		
Lane Group Flow (vph)	1833	0
Enter Blocked Intersection	No	No
Lane Alignment	Left	Right
Median Width(ft)	24	
Link Offset(ft)	0	
Crosswalk Width(ft)	16	
Two way Left Turn Lane		
Headway Factor	1.00	1.00
Turning Speed (mph)		9
Number of Detectors	1	
Detector Template		
Leading Detector (ft)	50	
Trailing Detector (ft)	0	
Detector 1 Position(ft)	0	
Detector 1 Size(ft)	50	
Detector 1 Type	Cl+Ex	
Detector 1 Channel		
Detector 1 Extend (s)	0.0	
Detector 1 Queue (s)	0.0	
Detector 1 Delay (s)	0.0	
Turn Type	NA	
Protected Phases	2	
Permitted Phases		
Detector Phase	2	
Switch Phase		
Minimum Initial (s)	18.0	
Minimum Split (s)	28.0	
Total Split (s)	75.0	

Pepper Square TIA  
Lanes, Volumes, Timings

Phase 1 - 2026 - Background - PM  
1371: Preston & Spring Valley

Lane Group	EBL	EBT	EBR	WBL	WBT	WBR	NBU	NBL	NBT	NBR	SBU	SBL
Total Split (%)	25.0%	31.3%	8.1%	14.4%	13.8%	13.8%	51.3%	9.4%	9.4%			
Maximum Green (s)	35.0	44.5	8.0	17.5	17.0	17.0	76.0	10.0	10.0			
Yellow Time (s)	3.0	4.0	3.0	4.0	3.0	3.0	4.5	3.0	3.0			
All-Red Time (s)	2.0	1.5	2.0	1.5	2.0	2.0	1.5	2.0	2.0			
Lost Time Adjust (s)	-1.0	-1.5	-1.0	-1.5	-1.0	-2.0	-1.0	-2.0	-1.0			
Total Lost Time (s)	4.0	4.0	4.0	4.0	4.0	4.0	4.0	4.0	4.0			
Lead/Lag	Lead	Lead	Lag	Lag	Lead	Lead	Lead	Lag	Lag			
Lead-Lag Optimize?	Yes	Yes	Yes	Yes	Yes	Yes	Yes	Yes	Yes			
Vehicle Extension (s)	0.8	2.0	0.8	2.0	0.8	0.8	2.5	0.8	0.8			
Recall Mode	None	Max	None	Max	None	None	None	None	None			
Walk Time (s)		4.0		4.0			4.0					
Flash Dont Walk (s)		18.0		18.0			18.0					
Pedestrian Calls (#/hr)		0		0			0					
Act Effect Green (s)	19.0	46.0	9.0	36.0			13.6	78.0				11.0
Actuated g/C Ratio	0.12	0.29	0.06	0.22			0.08	0.49				0.07
v/c Ratio	0.77	0.74	0.57	0.60			0.69	1.03				0.72
Control Delay	76.4	51.2	70.9	48.6			82.8	67.7				72.3
Queue Delay	0.0	0.0	0.0	0.0			0.0	0.0				0.0
Total Delay	76.4	51.2	70.9	48.6			82.8	67.7				72.3
LOS	E	D	E	D			F	E				E
Approach Delay		56.9		51.7			68.8					
Approach LOS		E		D			E					
Queue Length 50th (ft)	164	372	60	226			111	-800				90
Queue Length 95th (ft)	214	417	m57	m231			m155	#1080				m121
Internal Link Dist (ft)		3179		5408			2059					
Turn Bay Length (ft)	225		225				225					275
Base Capacity (vph)	772	1445	193	1134			386	2455				236
Starvation Cap Reductn	0	0	0	0			0	0				0
Spillback Cap Reductn	0	0	0	0			0	0				0
Storage Cap Reductn	0	0	0	0			0	0				0
Reduced v/c Ratio	0.41	0.74	0.57	0.60			0.52	1.03				0.72

Intersection Summary

Area Type:	Other
Cycle Length:	160
Actuated Cycle Length:	160
Offset:	135 (84%), Referenced to phase 2:SBT, Start of Yellow
Natural Cycle:	110
Control Type:	Actuated-Coordinated
Maximum v/c Ratio:	1.03
Intersection Signal Delay:	52.9
Intersection LOS:	D
Intersection Capacity Utilization:	87.6%
ICU Level of Service:	E
Analysis Period (min):	15
~	Volume exceeds capacity, queue is theoretically infinite. Queue shown is maximum after two cycles.
#	95th percentile volume exceeds capacity, queue may be longer. Queue shown is maximum after two cycles.
m	Volume for 95th percentile queue is metered by upstream signal.

Pepper Square TIA  
Lanes, Volumes, Timings

Phase 1 - 2026 - Background - PM  
1371: Preston & Spring Valley

Splits and Phases: 1371: Preston & Spring Valley

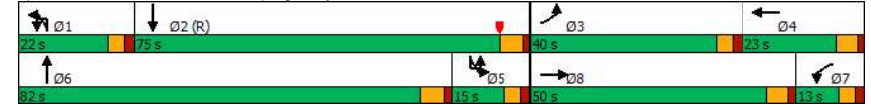

Pepper Square TIA  
Lanes, Volumes, Timings

Phase 1 - 2026 - Background - PM  
1371: Preston & Spring Valley

Lane Group	SBT	SBR
Total Split (%)	46.9%	
Maximum Green (s)	69.0	
Yellow Time (s)	4.5	
All-Red Time (s)	1.5	
Lost Time Adjust (s)	-2.0	
Total Lost Time (s)	4.0	
Lead/Lag	Lag	
Lead-Lag Optimize?	Yes	
Vehicle Extension (s)	2.4	
Recall Mode	C-Max	
Walk Time (s)	4.0	
Flash Dont Walk (s)	18.0	
Pedestrian Calls (#/hr)	0	
Act Effect Green (s)	75.4	
Actuated g/C Ratio	0.47	
v/c Ratio	0.78	
Control Delay	24.9	
Queue Delay	0.0	
Total Delay	24.9	
LOS	C	
Approach Delay	28.9	
Approach LOS	C	
Queue Length 50th (ft)	234	
Queue Length 95th (ft)	526	
Internal Link Dist (ft)	1128	
Turn Bay Length (ft)		
Base Capacity (vph)	2365	
Starvation Cap Reductn	0	
Spillback Cap Reductn	0	
Storage Cap Reductn	0	
Reduced v/c Ratio	0.78	
<b>Intersection Summary</b>		

Pepper Square TIA  
Lanes, Volumes, Timings

Phase 1 - 2026 - Background - PM  
1405: Prestonwood & Belt Line

Lane Group	EBU	EBL	EBT	EBR	WBU	WBL	WBT	WBR	NBL	NBT	NBR	SBL
Lane Configurations		↔	↔↔↔			↔	↔↔↔			↔	↔	↔↔
Traffic Volume (vph)	7	79	1588	7	3	2	1280	105	6	1	2	150
Future Volume (vph)	7	79	1588	7	3	2	1280	105	6	1	2	150
Ideal Flow (vphpl)	1900	1900	1900	1900	1900	1900	1900	1900	1900	1900	1900	1900
Storage Length (ft)		200		0		200		0	0		0	300
Storage Lanes		1		0		1		0	0		0	2
Taper Length (ft)		25				25		25				25
Lane Util. Factor	0.91	1.00	0.91	0.91	0.91	1.00	0.91	0.91	1.00	1.00	1.00	0.97
Fit			0.999				0.989			0.970		
Fit Protected		0.950				0.950				0.968		0.950
Satd. Flow (prot)	0	1770	5080	0	0	1770	5029	0	0	1749	0	3433
Fit Permitted		0.078				0.120				0.968		0.950
Satd. Flow (perm)	0	145	5080	0	0	224	5029	0	0	1749	0	3433
Right Turn on Red			Yes				Yes			Yes		Yes
Satd. Flow (RTOR)			1				13			2		
Link Speed (mph)			42				42			30		
Link Distance (ft)			1445				2036			315		
Travel Time (s)			23.5				33.1			7.2		
Peak Hour Factor	0.95	0.95	0.95	0.95	0.95	0.95	0.95	0.95	0.95	0.95	0.95	0.95
Adj. Flow (vph)	7	83	1672	7	3	2	1347	111	6	1	2	158
Shared Lane Traffic (%)												
Lane Group Flow (vph)	0	90	1679	0	0	5	1458	0	0	9	0	158
Enter Blocked Intersection	No	No	No	No	No	No	No	No	No	No	No	No
Lane Alignment	R NA	Left	Left	Right	R NA	Left	Left	Right	Left	Left	Right	Left
Median Width(ft)			24				24			24		
Link Offset(ft)			0				0			0		
Crosswalk Width(ft)			16				16			16		
Two way Left Turn Lane												
Headway Factor	1.00	1.00	1.00	1.00	1.00	1.00	1.00	1.00	1.00	1.00	1.00	1.00
Turning Speed (mph)	9	15		9	9	15		9	15		9	15
Number of Detectors	1	1	1		1	1	1		1	1		1
Detector Template												
Leading Detector (ft)	50	50	50		50	50	50		50	50		50
Trailing Detector (ft)	0	0	0		0	0	0		0	0		0
Detector 1 Position(ft)	0	0	0		0	0	0		0	0		0
Detector 1 Size(ft)	50	50	50		50	50	50		50	50		50
Detector 1 Type	CI+Ex	CI+Ex	CI+Ex		CI+Ex	CI+Ex	CI+Ex		CI+Ex	CI+Ex		CI+Ex
Detector 1 Channel												
Detector 1 Extend (s)	0.0	0.0	0.0		0.0	0.0	0.0		0.0	0.0		0.0
Detector 1 Queue (s)	0.0	0.0	0.0		0.0	0.0	0.0		0.0	0.0		0.0
Detector 1 Delay (s)	0.0	0.0	0.0		0.0	0.0	0.0		0.0	0.0		0.0
Turn Type	D,P+P	D,P+P	NA		custom	D,P+P	NA		Split	NA		Split
Protected Phases	1	1	6			5	2		3	3		4
Permitted Phases	2	2			5	6						
Detector Phase	1	1	6		5	5	2		3	3		4
Switch Phase												
Minimum Initial (s)	3.0	3.0	15.0		3.0	3.0	15.0		5.0	5.0		7.0
Minimum Split (s)	8.0	8.0	22.0		8.0	8.0	24.0		23.0	23.0		23.2
Total Split (s)	25.0	25.0	99.0		15.0	15.0	89.0		18.0	18.0		28.0



Pepper Square TIA  
Lanes, Volumes, Timings

Phase 1 - 2026 - Background - PM  
1405: Prestonwood & Belt Line

Lane Group	SBT	SBR
Lane Configurations	↓	↑
Traffic Volume (vph)	2	82
Future Volume (vph)	2	82
Ideal Flow (vphpl)	1900	1900
Storage Length (ft)		0
Storage Lanes		1
Taper Length (ft)		
Lane Util. Factor	0.95	0.95
Frt	0.857	0.850
Fit Protected		
Satd. Flow (prot)	1517	1504
Fit Permitted		
Satd. Flow (perm)	1517	1504
Right Turn on Red		Yes
Satd. Flow (RTOR)	42	89
Link Speed (mph)	30	
Link Distance (ft)	868	
Travel Time (s)	19.7	
Peak Hour Factor	0.95	0.95
Adj. Flow (vph)	2	86
Shared Lane Traffic (%)		49%
Lane Group Flow (vph)	44	44
Enter Blocked Intersection	No	No
Lane Alignment	Left	Right
Median Width(ft)	24	
Link Offset(ft)	0	
Crosswalk Width(ft)	16	
Two way Left Turn Lane		
Headway Factor	1.00	1.00
Turning Speed (mph)		9
Number of Detectors	1	1
Detector Template		
Leading Detector (ft)	50	50
Trailing Detector (ft)	0	0
Detector 1 Position(ft)	0	0
Detector 1 Size(ft)	50	50
Detector 1 Type	CI+Ex	CI+Ex
Detector 1 Channel		
Detector 1 Extend (s)	0.0	0.0
Detector 1 Queue (s)	0.0	0.0
Detector 1 Delay (s)	0.0	0.0
Turn Type	NA	custom
Protected Phases	4	
Permitted Phases		1 4
Detector Phase	4	1 4
Switch Phase		
Minimum Initial (s)	7.0	
Minimum Split (s)	23.2	
Total Split (s)	28.0	

Pepper Square TIA  
Lanes, Volumes, Timings

Phase 1 - 2026 - Background - PM  
1405: Prestonwood & Belt Line

Lane Group	EBU	EBL	EBT	EBR	WBU	WBL	WBT	WBR	NBL	NBT	NBR	SBL
Total Split (%)	15.6%	15.6%	61.9%		9.4%	9.4%	55.6%		11.3%	11.3%		17.5%
Maximum Green (s)	20.0	20.0	93.0		10.0	10.0	83.0		13.0	13.0		22.8
Yellow Time (s)	3.0	3.0	4.5		3.0	3.0	4.5		3.0	3.0		3.2
All-Red Time (s)	2.0	2.0	1.5		2.0	2.0	1.5		2.0	2.0		2.0
Lost Time Adjust (s)		-1.0	-2.0			-1.0	-2.0			-1.0		-1.2
Total Lost Time (s)		4.0	4.0			4.0	4.0			4.0		4.0
Lead/Lag	Lag	Lag	Lag		Lead	Lead	Lead		Lead	Lead		Lag
Lead-Lag Optimize?	Yes	Yes	Yes		Yes	Yes	Yes		Yes	Yes		Yes
Vehicle Extension (s)	1.0	1.0	2.5		1.0	1.0	2.5		1.5	1.5		1.5
Recall Mode	None	None	C-Max		None	None	None		None	None		None
Walk Time (s)			5.0				4.0		4.0	4.0		4.0
Flash Dont Walk (s)			10.0				14.0		14.0	14.0		14.0
Pedestrian Calls (#/hr)			0				0		0	0		0
Act Effect Green (s)		131.3	133.5			134.5	73.8			6.3		12.5
Actuated g/C Ratio		0.82	0.83			0.84	0.46			0.04		0.08
v/c Ratio		0.13	0.40			0.02	0.63			0.13		0.59
Control Delay		16.0	4.7			0.8	21.2			67.0		80.2
Queue Delay		0.0	0.0			0.0	0.0			0.0		0.0
Total Delay		16.0	4.7			0.8	21.2			67.0		80.2
LOS		B	A			A	C			E		F
Approach Delay			5.2				21.1			67.0		
Approach LOS			A				C			E		
Queue Length 50th (ft)		10	43			0	161			7		84
Queue Length 95th (ft)		52	390			m1	m309			28		121
Internal Link Dist (ft)			1365				1956			235		
Turn Bay Length (ft)		200				200						300
Base Capacity (vph)		701	4238			295	2677			154		514
Starvation Cap Reductn		0	0			0	0			0		0
Spillback Cap Reductn		0	0			0	0			0		0
Storage Cap Reductn		0	0			0	0			0		0
Reduced v/c Ratio		0.13	0.40			0.02	0.54			0.06		0.31

**Intersection Summary**  
 Area Type: Other  
 Cycle Length: 160  
 Actuated Cycle Length: 160  
 Offset: 60 (38%), Referenced to phase 6:EBWB, Start of Yellow  
 Natural Cycle: 90  
 Control Type: Actuated-Coordinated  
 Maximum v/c Ratio: 0.63  
 Intersection Signal Delay: 15.6  
 Intersection LOS: B  
 Intersection Capacity Utilization 52.7%  
 ICU Level of Service A  
 Analysis Period (min) 15  
 m Volume for 95th percentile queue is metered by upstream signal.

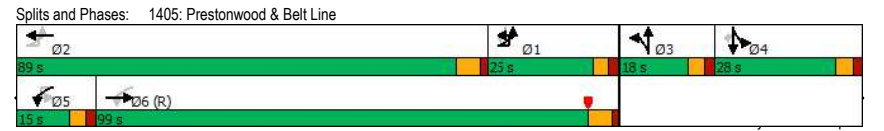

Pepper Square TIA  
Lanes, Volumes, Timings

Phase 1 - 2026 - Background - PM  
1405: Prestonwood & Belt Line



Lane Group	SBT	SBR
Total Split (%)	17.5%	
Maximum Green (s)	22.8	
Yellow Time (s)	3.2	
All-Red Time (s)	2.0	
Lost Time Adjust (s)	-1.2	
Total Lost Time (s)	4.0	
Lead/Lag	Lag	
Lead-Lag Optimize?	Yes	
Vehicle Extension (s)	1.5	
Recall Mode	None	
Walk Time (s)	4.0	
Flash Dont Walk (s)	14.0	
Pedestrian Calls (#/hr)	0	
Act Effect Green (s)	12.5	72.3
Actuated g/C Ratio	0.08	0.45
v/c Ratio	0.28	0.06
Control Delay	23.6	0.2
Queue Delay	0.0	0.0
Total Delay	23.6	0.2
LOS	C	A
Approach Delay	55.8	
Approach LOS	E	
Queue Length 50th (ft)	2	0
Queue Length 95th (ft)	46	0
Internal Link Dist (ft)	788	
Turn Bay Length (ft)		
Base Capacity (vph)	263	830
Starvation Cap Reductn	0	0
Spillback Cap Reductn	0	0
Storage Cap Reductn	0	0
Reduced v/c Ratio	0.17	0.05
<b>Intersection Summary</b>		

Pepper Square TIA  
HCM 6th TWSC

Phase 1 - 2026 - Background - PM  
2: Ladera Drive & Belt Line

Intersection												
Int Delay, s/veh	4.9											
Movement	EBL	EBT	EBR	WBL	WBT	WBR	NBL	NBT	NBR	SBL	SBT	SBR
Lane Configurations	↔ ↑↑↑			↔ ↑↑↑			↔ ↑↑			↔ ↑↑		
Traffic Vol, veh/h	115	1622	56	76	1272	63	16	1	48	26	1	71
Future Vol, veh/h	115	1622	56	76	1272	63	16	1	48	26	1	71
Conflicting Peds, #/hr	0	0	0	0	0	0	0	0	0	0	0	0
Sign Control	Free	Free	Free	Free	Free	Stop	Stop	Stop	Stop	Stop	Stop	Stop
RT Channelized	-	-	None	-	-	None	-	-	None	-	-	None
Storage Length	100	-	-	100	-	-	-	-	0	-	-	0
Veh in Median Storage, #	-	0	-	-	0	-	-	-	1	-	-	1
Grade, %	-	0	-	-	0	-	-	-	0	-	-	0
Peak Hour Factor	96	96	96	96	96	96	96	96	96	96	96	96
Heavy Vehicles, %	2	2	2	2	2	2	2	2	2	2	2	2
Mvmt Flow	120	1690	58	79	1325	66	17	1	50	27	1	74

Major/Minor	Major1	Major2	Minor1	Minor2
Conflicting Flow All	1391	0	0	1748
Stage 1	-	-	-	-
Stage 2	-	-	-	-
Critical Hdwy	5.34	-	-	5.34
Critical Hdwy Stg 1	-	-	-	-
Critical Hdwy Stg 2	-	-	-	-
Follow-up Hdwy	3.12	-	-	3.12
Pot Cap-1 Maneuver	252	-	-	*681
Stage 1	-	-	-	-
Stage 2	-	-	-	-
Platoon blocked, %	-	-	-	-
Mov Cap-1 Maneuver	252	-	-	*681
Mov Cap-2 Maneuver	-	-	-	-
Stage 1	-	-	-	-
Stage 2	-	-	-	-

Approach	EB	WB	NB	SB
HCM Control Delay, s	2	0.6	25.4	106.5
HCM LOS			D	F

Minor Lane/Major Mvmt	NBLn1	NBLn2	EBL	EBT	EBR	WBL	WBT	WBR	SBLn1	SBLn2
Capacity (veh/h)	80	541	252	-	-	*681	-	-	30	329
HCM Lane V/C Ratio	0.221	0.092	0.475	-	-	0.116	-	-	0.938	0.225
HCM Control Delay (s)	62.4	12.3	31.6	-	-	11	-	-	\$336.4	19.1
HCM Lane LOS	F	B	D	-	-	B	-	-	F	C
HCM 95th %tile Q(veh)	0.8	0.3	2.4	-	-	0.4	-	-	3.1	0.8

Notes  
 ~: Volume exceeds capacity    \$: Delay exceeds 300s    +: Computation Not Defined    \*: All major volume in platoon

Pepper Square TIA  
HCM 6th TWSC

Phase 1 - 2026 - Background - PM  
3: Median Opening East of Preston Rd & Belt Line

Intersection															
Int Delay, s/veh	0.5														
Movement	EBU	EBL	EBT	EBR	WBU	WBL	WBT	WBR	NBL	NBT	NBR	SBL	SBT	SBR	
Lane Configurations	↔ ↑↑↑			↔ ↑↑↑			↔ ↑↑			↔ ↑↑			↔ ↑↑		
Traffic Vol, veh/h	6	6	1179	12	1	13	869	5	2	0	2	21	1	22	
Future Vol, veh/h	6	6	1179	12	1	13	869	5	2	0	2	21	1	22	
Conflicting Peds, #/hr	0	0	0	0	0	0	0	0	0	0	0	0	0	0	
Sign Control	Free	Free	Free	Free	Free	Free	Free	Free	Stop	Stop	Stop	Stop	Stop	Stop	
RT Channelized	-	-	-	None	-	-	-	None	-	-	None	-	-	None	
Storage Length	-	150	-	-	-	200	-	-	-	-	-	-	-	-	
Veh in Median Storage, #	-	-	0	-	-	0	-	-	-	-	1	-	-	1	
Grade, %	-	-	0	-	-	0	-	-	-	-	0	-	-	0	
Peak Hour Factor	93	93	93	93	93	93	93	93	93	93	93	93	93	93	
Heavy Vehicles, %	2	2	2	2	2	2	2	2	2	2	2	2	2	2	
Mvmt Flow	6	6	1268	13	1	14	934	5	2	0	2	23	1	24	

Major/Minor	Major1	Major2	Minor1	Minor2
Conflicting Flow All	686	939	0	0
Stage 1	-	-	-	-
Stage 2	-	-	-	-
Critical Hdwy	5.64	5.34	-	-
Critical Hdwy Stg 1	-	-	-	-
Critical Hdwy Stg 2	-	-	-	-
Follow-up Hdwy	2.32	3.12	-	-
Pot Cap-1 Maneuver	*1216	*904	-	-
Stage 1	-	-	-	-
Stage 2	-	-	-	-
Platoon blocked, %	1	1	-	-
Mov Cap-1 Maneuver	*1023	*1023	-	-
Mov Cap-2 Maneuver	-	-	-	-
Stage 1	-	-	-	-
Stage 2	-	-	-	-

Approach	EB	WB	NB	SB
HCM Control Delay, s	0.1	0.3	29.5	13.6
HCM LOS			D	B

Minor Lane/Major Mvmt	NBLn1	EBL	EBT	EBR	WBL	WBT	WBR	SBLn1
Capacity (veh/h)	151	*1023	-	-	294	-	-	468
HCM Lane V/C Ratio	0.028	0.013	-	-	0.051	-	-	0.101
HCM Control Delay (s)	29.5	8.6	-	-	17.9	-	-	13.6
HCM Lane LOS	D	A	-	-	C	-	-	B
HCM 95th %tile Q(veh)	0.1	0	-	-	0.2	-	-	0.3

Notes  
 ~: Volume exceeds capacity    \$: Delay exceeds 300s    +: Computation Not Defined    \*: All major volume in platoon

Pepper Square TIA  
HCM 6th TWSC

Phase 1 - 2026 - Background - PM  
5: Belt Line & Median between Berry Trail and Alexis Dr

Intersection												
Int Delay, s/veh	0.3											
Movement	EBL	EBT	EBR	WBL	WBT	WBR	NBL	NBT	NBR	SBL	SBT	SBR
Lane Configurations	↔ ↑↑↔			↔ ↑↑↔			↔			↔		
Traffic Vol, veh/h	8	1234	2	27	876	12	3	4	11	4	1	7
Future Vol, veh/h	8	1234	2	27	876	12	3	4	11	4	1	7
Conflicting Peds, #/hr	0	0	0	0	0	0	0	0	0	0	0	0
Sign Control	Free	Free	Free	Free	Free	Stop	Stop	Stop	Stop	Stop	Stop	Stop
RT Channelized	-	-	None	-	-	None	-	-	None	-	-	None
Storage Length	150	-	-	150	-	-	-	-	-	-	-	-
Veh in Median Storage, #	-	0	-	-	0	-	-	1	-	-	1	-
Grade, %	-	0	-	-	0	-	-	0	-	-	0	-
Peak Hour Factor	94	94	94	94	94	94	94	94	94	94	94	94
Heavy Vehicles, %	2	2	2	2	2	2	2	2	2	2	2	2
Mvmt Flow	9	1313	2	29	932	13	3	4	12	4	1	7

Major/Minor	Major1	Major2	Minor1	Minor2
Conflicting Flow All	945	0	0	1315
Stage 1	-	-	-	-
Stage 2	-	-	-	-
Critical Hdwy	5.34	-	-	5.34
Critical Hdwy Stg 1	-	-	-	-
Critical Hdwy Stg 2	-	-	-	-
Follow-up Hdwy	3.12	-	-	3.12
Pot Cap-1 Maneuver	*904	-	-	*803
Stage 1	-	-	-	-
Stage 2	-	-	-	-
Platoon blocked, %	1	-	-	1
Mov Cap-1 Maneuver	*904	-	-	*803
Mov Cap-2 Maneuver	-	-	-	-
Stage 1	-	-	-	-
Stage 2	-	-	-	-

Approach	EB	WB	NB	SB
HCM Control Delay, s	0.1	0.3	11.7	11.2
HCM LOS			B	B

Minor Lane/Major Mvmt	NBLn1	EBL	EBT	EBR	WBL	WBT	WBR	SBLn1
Capacity (veh/h)	556	*904	-	-	*803	-	-	597
HCM Lane V/C Ratio	0.034	0.009	-	-	0.036	-	-	0.021
HCM Control Delay (s)	11.7	9	-	-	9.6	-	-	11.2
HCM Lane LOS	B	A	-	-	A	-	-	B
HCM 95th %tile Q(veh)	0.1	0	-	-	0.1	-	-	0.1

Notes  
 ~: Volume exceeds capacity    \$: Delay exceeds 300s    +: Computation Not Defined    \*: All major volume in platoon

Pepper Square TIA  
HCM 6th TWSC

Phase 1 - 2026 - Background - PM  
6: Alexis Drive & Belt Line

Intersection						
Int Delay, s/veh	2.8					
Movement	EBT	EBR	WBL	WBT	NBL	NBR
Lane Configurations	↑↑↔		↔ ↑↑↔		↔	
Traffic Vol, veh/h	1220	15	217	904	3	302
Future Vol, veh/h	1220	15	217	904	3	302
Conflicting Peds, #/hr	0	0	0	0	0	0
Sign Control	Free	Free	Free	Free	Stop	Stop
RT Channelized	-	None	-	None	-	Yield
Storage Length	-	-	150	-	0	0
Veh in Median Storage, #	0	-	-	0	1	-
Grade, %	0	-	-	0	0	-
Peak Hour Factor	95	95	95	95	95	95
Heavy Vehicles, %	2	2	2	2	2	2
Mvmt Flow	1284	16	228	952	3	318

Major/Minor	Major1	Major2	Minor1
Conflicting Flow All	0	0	1300
Stage 1	-	-	-
Stage 2	-	-	-
Critical Hdwy	-	-	5.34
Critical Hdwy Stg 1	-	-	-
Critical Hdwy Stg 2	-	-	-
Follow-up Hdwy	-	-	3.12
Pot Cap-1 Maneuver	-	-	*803
Stage 1	-	-	-
Stage 2	-	-	-
Platoon blocked, %	-	-	1
Mov Cap-1 Maneuver	-	-	*803
Mov Cap-2 Maneuver	-	-	-
Stage 1	-	-	-
Stage 2	-	-	-

Approach	EB	WB	NB
HCM Control Delay, s	0	2.2	16.1
HCM LOS			C

Minor Lane/Major Mvmt	NBLn1	NBLn2	EBT	EBR	WBL	WBT
Capacity (veh/h)	411	638	-	-	*803	-
HCM Lane V/C Ratio	0.008	0.498	-	-	0.284	-
HCM Control Delay (s)	13.8	16.1	-	-	11.3	-
HCM Lane LOS	B	C	-	-	B	-
HCM 95th %tile Q(veh)	0	2.8	-	-	1.2	-

Notes  
 ~: Volume exceeds capacity    \$: Delay exceeds 300s    +: Computation Not Defined    \*: All major volume in platoon

Intersection														
Int Delay, s/veh	6.5													
Movement	EBL	EBT	EBR	WBL	WBT	WBR	NBL	NBT	NBR	SBL	SBT	SBR		
Lane Configurations	↔			↔			↕↕↕			↕↕↕				
Traffic Vol, veh/h	11	5	60	9	2	53	4	94	2245	34	6	24	1757	69
Future Vol, veh/h	11	5	60	9	2	53	4	94	2245	34	6	24	1757	69
Conflicting Peds, #/hr	0	0	0	0	0	0	0	0	0	0	0	0	0	0
Sign Control	Stop	Stop	Stop	Stop	Stop	Free	Free	Free	Free	Free	Free	Free	Free	Free
RT Channelized	-	-	None	-	-	None	-	-	None	-	-	-	None	-
Storage Length	-	-	-	-	-	-	-	150	-	-	-	150	-	-
Veh in Median Storage, #	-	1	-	-	1	-	-	0	-	-	-	0	-	-
Grade, %	-	0	-	-	0	-	-	0	-	-	-	0	-	-
Peak Hour Factor	97	97	97	97	97	97	97	97	97	97	97	97	97	97
Heavy Vehicles, %	2	2	2	2	2	2	2	2	2	2	2	2	2	2
Mvmt Flow	11	5	62	9	2	55	4	97	2314	35	6	25	1811	71

Major/Minor	Minor2	Minor1	Major1	Major2		
Conflicting Flow All	3038	4460	941	3323	4478	1175 1374 1882
Stage 1	1909	1909	-	2534	2534	-
Stage 2	1129	2551	-	789	1944	-
Critical Hdwy	6.44	6.54	7.14	6.44	6.54	7.14 5.64 5.34
Critical Hdwy Stg 1	7.34	5.54	-	7.34	5.54	-
Critical Hdwy Stg 2	6.74	5.54	-	6.74	5.54	-
Follow-up Hdwy	3.82	4.02	3.92	3.82	4.02	3.92 2.32 3.12
Pot Cap-1 Maneuver	*40	*1	*525	*19	*1	158 *888 *660
Stage 1	*539	*512	-	*16	55	-
Stage 2	*195	*53	-	*539	495	-
Platoon blocked, %	1	1	1	1	1	1
Mov Cap-1 Maneuver	*17	*0	*525	*11	*0	158 *664 *664
Mov Cap-2 Maneuver	*60	*12	-	*13	35	-
Stage 1	*457	*332	-	*14	47	-
Stage 2	*103	*45	-	*303	321	-

Approach	EB	WB	NB	SB
HCM Control Delay, s	101.7	269.9	0.5	1.1
HCM LOS	F	F		

Minor Lane/Major Mvmt	NBL	NBT	NBR	EBLn1	WBLn1	SBL	SBT	SBR
Capacity (veh/h)	*664	-	-	106	59	88	-	-
HCM Lane V/C Ratio	0.152	-	-	0.739	1.118	0.351	-	-
HCM Control Delay (s)	11.4	-	-	101.7	269.9	66.6	-	-
HCM Lane LOS	B	-	-	F	F	F	-	-
HCM 95th %tile Q(veh)	0.5	-	-	4	5.4	1.4	-	-

Notes  
 ~: Volume exceeds capacity \$: Delay exceeds 300s +: Computation Not Defined \*: All major volume in platoon

Intersection						
Int Delay, s/veh	0.1					
Movement	WBL	WBR	NBT	NBR	SBL	SBT
Lane Configurations	↕↕↕		↕↕↕		↕↕↕	
Traffic Vol, veh/h	0	14	2293	8	0	1941
Future Vol, veh/h	0	14	2293	8	0	1941
Conflicting Peds, #/hr	0	0	0	0	0	0
Sign Control	Stop	Stop	Free	Free	Free	Free
RT Channelized	-	None	-	None	-	None
Storage Length	-	0	-	-	-	-
Veh in Median Storage, #	0	-	0	-	-	0
Grade, %	0	-	0	-	-	0
Peak Hour Factor	95	95	95	95	95	95
Heavy Vehicles, %	2	2	2	2	2	2
Mvmt Flow	0	15	2414	8	0	2043

Major/Minor	Minor1	Major1	Major2		
Conflicting Flow All	-	1211	0	0	-
Stage 1	-	-	-	-	-
Stage 2	-	-	-	-	-
Critical Hdwy	-	7.14	-	-	-
Critical Hdwy Stg 1	-	-	-	-	-
Critical Hdwy Stg 2	-	-	-	-	-
Follow-up Hdwy	-	3.92	-	-	-
Pot Cap-1 Maneuver	0	150	-	0	-
Stage 1	0	-	-	0	-
Stage 2	0	-	-	0	-
Platoon blocked, %	-	-	-	-	-
Mov Cap-1 Maneuver	-	150	-	-	-
Mov Cap-2 Maneuver	-	-	-	-	-
Stage 1	-	-	-	-	-
Stage 2	-	-	-	-	-

Approach	WB	NB	SB
HCM Control Delay, s	31.6	0	0
HCM LOS	D		

Minor Lane/Major Mvmt	NBT	NBR	WBLn1	SBT
Capacity (veh/h)	-	-	150	-
HCM Lane V/C Ratio	-	-	0.098	-
HCM Control Delay (s)	-	-	31.6	-
HCM Lane LOS	-	-	D	-
HCM 95th %tile Q(veh)	-	-	0.3	-

Pepper Square TIA  
HCM 6th TWSC

Phase 1 - 2026 - Background - PM  
21: Preston & Drive 1

Intersection						
Int Delay, s/veh	0					
Movement	WBL	WBR	NBT	NBR	SBL	SBT
Lane Configurations		↑↑↑	↑↑↑			↑↑↑
Traffic Vol, veh/h	0	2	2378	2	0	1779
Future Vol, veh/h	0	2	2378	2	0	1779
Conflicting Peds, #/hr	0	0	0	0	0	0
Sign Control	Stop	Stop	Free	Free	Free	Free
RT Channelized	-	None	-	None	-	None
Storage Length	-	0	-	-	-	-
Veh in Median Storage, #	0	-	0	-	0	0
Grade, %	0	-	0	-	0	0
Peak Hour Factor	95	95	95	95	95	95
Heavy Vehicles, %	2	2	2	2	2	2
Mvmt Flow	0	2	2503	2	0	1873

Major/Minor	Minor1	Major1	Major2		
Conflicting Flow All	-	1253	0	0	-
Stage 1	-	-	-	-	-
Stage 2	-	-	-	-	-
Critical Hdwy	-	7.14	-	-	-
Critical Hdwy Stg 1	-	-	-	-	-
Critical Hdwy Stg 2	-	-	-	-	-
Follow-up Hdwy	-	3.92	-	-	-
Pot Cap-1 Maneuver	0	140	-	0	-
Stage 1	0	-	-	0	-
Stage 2	0	-	-	0	-
Platoon blocked, %	-	-	-	-	-
Mov Cap-1 Maneuver	-	140	-	-	-
Mov Cap-2 Maneuver	-	-	-	-	-
Stage 1	-	-	-	-	-
Stage 2	-	-	-	-	-

Approach	WB	NB	SB
HCM Control Delay, s	31.1	0	0
HCM LOS	D		

Minor Lane/Major Mvmt	NBT	NBRWBLn1	SBT
Capacity (veh/h)	-	140	-
HCM Lane V/C Ratio	-	0.015	-
HCM Control Delay (s)	-	31.1	-
HCM Lane LOS	-	D	-
HCM 95th %tile Q(veh)	-	0	-

Pepper Square TIA  
HCM 6th TWSC

Phase 1 - 2026 - Background - PM  
22: Drive 6 & Belt Line

Intersection						
Int Delay, s/veh	0.1					
Movement	EBT	EBR	WBL	WBT	NBL	NBR
Lane Configurations	↑↑↑			↑↑↑		↑
Traffic Vol, veh/h	1225	8	0	883	0	8
Future Vol, veh/h	1225	8	0	883	0	8
Conflicting Peds, #/hr	0	0	0	0	0	0
Sign Control	Free	Free	Free	Free	Stop	Stop
RT Channelized	-	None	-	None	-	None
Storage Length	-	-	-	-	-	0
Veh in Median Storage, #	0	-	-	0	0	-
Grade, %	0	-	-	0	0	-
Peak Hour Factor	93	93	93	93	93	93
Heavy Vehicles, %	2	2	2	2	2	2
Mvmt Flow	1317	9	0	949	0	9

Major/Minor	Major1	Major2	Minor1		
Conflicting Flow All	0	0	-	-	663
Stage 1	-	-	-	-	-
Stage 2	-	-	-	-	-
Critical Hdwy	-	-	-	-	7.14
Critical Hdwy Stg 1	-	-	-	-	-
Critical Hdwy Stg 2	-	-	-	-	-
Follow-up Hdwy	-	-	-	-	3.92
Pot Cap-1 Maneuver	-	0	-	0	346
Stage 1	-	0	-	0	-
Stage 2	-	0	-	0	-
Platoon blocked, %	-	-	-	-	-
Mov Cap-1 Maneuver	-	-	-	-	346
Mov Cap-2 Maneuver	-	-	-	-	-
Stage 1	-	-	-	-	-
Stage 2	-	-	-	-	-

Approach	EB	WB	NB
HCM Control Delay, s	0	0	15.7
HCM LOS			C

Minor Lane/Major Mvmt	NBLn1	EBT	EBR	WBT
Capacity (veh/h)	346	-	-	-
HCM Lane V/C Ratio	0.025	-	-	-
HCM Control Delay (s)	15.7	-	-	-
HCM Lane LOS	C	-	-	-
HCM 95th %tile Q(veh)	0.1	-	-	-

Pepper Square TIA  
HCM 6th TWSC

Phase 1 - 2026 - Background - PM  
24: Drive 5 & Belt Line

Intersection						
Int Delay, s/veh	0					
Movement	EBT	EBR	WBL	WBT	NBL	NBR
Lane Configurations	↑↑↑			↑↑↑		↑
Traffic Vol, veh/h	1207	0	0	839	0	5
Future Vol, veh/h	1207	0	0	839	0	5
Conflicting Peds, #/hr	0	0	0	0	0	0
Sign Control	Free	Free	Free	Free	Stop	Stop
RT Channelized	-	None	-	None	-	None
Storage Length	-	-	-	-	-	0
Veh in Median Storage, #	0	-	-	0	0	-
Grade, %	0	-	-	0	0	-
Peak Hour Factor	93	93	93	93	93	93
Heavy Vehicles, %	2	2	2	2	2	2
Mvmt Flow	1298	0	0	902	0	5

Major/Minor	Major1	Major2	Minor1
Conflicting Flow All	0	0	- 649
Stage 1	-	-	-
Stage 2	-	-	-
Critical Hdwy	-	-	- 7.14
Critical Hdwy Stg 1	-	-	-
Critical Hdwy Stg 2	-	-	-
Follow-up Hdwy	-	-	- 3.92
Pot Cap-1 Maneuver	-	0	- 0 354
Stage 1	-	0	- 0
Stage 2	-	0	- 0
Platoon blocked, %	-	-	-
Mov Cap-1 Maneuver	-	-	- 354
Mov Cap-2 Maneuver	-	-	-
Stage 1	-	-	-
Stage 2	-	-	-

Approach	EB	WB	NB
HCM Control Delay, s	0	0	15.3
HCM LOS			C

Minor Lane/Major Mvmt	NBLn1	EBT	EBR	WBT
Capacity (veh/h)	354	-	-	-
HCM Lane V/C Ratio	0.015	-	-	-
HCM Control Delay (s)	15.3	-	-	-
HCM Lane LOS	C	-	-	-
HCM 95th %tile Q(veh)	0	-	-	-

Pepper Square TIA  
HCM 6th TWSC

Phase 1 - 2026 - Background - PM  
25: Preston & Drive 4

Intersection						
Int Delay, s/veh	0.1					
Movement	WBL	WBR	NBT	NBR	SBL	SBT
Lane Configurations		↑↑↑	↑↑↑			↑↑↑
Traffic Vol, veh/h	0	10	2379	9	0	1941
Future Vol, veh/h	0	10	2379	9	0	1941
Conflicting Peds, #/hr	0	0	0	0	0	0
Sign Control	Stop	Stop	Free	Free	Free	Free
RT Channelized	-	None	-	None	-	None
Storage Length	-	0	-	-	-	-
Veh in Median Storage, #	0	-	0	-	-	0
Grade, %	0	-	0	-	-	0
Peak Hour Factor	95	95	95	95	95	95
Heavy Vehicles, %	2	2	2	2	2	2
Mvmt Flow	0	11	2504	9	0	2043

Major/Minor	Minor1	Major1	Major2
Conflicting Flow All	- 1257	0	0 - -
Stage 1	-	-	- - -
Stage 2	-	-	- - -
Critical Hdwy	- 7.14	-	- - -
Critical Hdwy Stg 1	-	-	- - -
Critical Hdwy Stg 2	-	-	- - -
Follow-up Hdwy	- 3.92	-	- - -
Pot Cap-1 Maneuver	0 139	-	- 0 -
Stage 1	0	-	- 0 -
Stage 2	0	-	- 0 -
Platoon blocked, %	-	-	- - -
Mov Cap-1 Maneuver	- 139	-	- - -
Mov Cap-2 Maneuver	-	-	- - -
Stage 1	-	-	- - -
Stage 2	-	-	- - -

Approach	WB	NB	SB
HCM Control Delay, s	33	0	0
HCM LOS	D		

Minor Lane/Major Mvmt	NBT	NBRWBLn1	SBT
Capacity (veh/h)	-	- 139	-
HCM Lane V/C Ratio	-	- 0.076	-
HCM Control Delay (s)	-	- 33	-
HCM Lane LOS	-	- D	-
HCM 95th %tile Q(veh)	-	- 0.2	-

**Intersection**

Int Delay, s/veh 0.3

Movement	WBL	WBR	NBT	NBR	SBL	SBT
Lane Configurations			↑↑↑			↑↑↑
Traffic Vol, veh/h	0	30	2379	17	0	1941
Future Vol, veh/h	0	30	2379	17	0	1941
Conflicting Peds, #/hr	0	0	0	0	0	0
Sign Control	Stop	Stop	Free	Free	Free	Free
RT Channelized	-	None	-	None	-	None
Storage Length	-	0	-	-	-	-
Veh in Median Storage, #	0	-	0	-	-	0
Grade, %	0	-	0	-	-	0
Peak Hour Factor	95	95	95	95	95	95
Heavy Vehicles, %	2	2	2	2	2	2
Mvmt Flow	0	32	2504	18	0	2043

**Major/Minor**

	Minor1	Major1	Major2		
Conflicting Flow All	-	1261	0	0	-
Stage 1	-	-	-	-	-
Stage 2	-	-	-	-	-
Critical Hdwy	-	7.14	-	-	-
Critical Hdwy Stg 1	-	-	-	-	-
Critical Hdwy Stg 2	-	-	-	-	-
Follow-up Hdwy	-	3.92	-	-	-
Pot Cap-1 Maneuver	0	138	-	-	0
Stage 1	0	-	-	-	0
Stage 2	0	-	-	-	0
Platoon blocked, %	-	-	-	-	-
Mov Cap-1 Maneuver	-	138	-	-	-
Mov Cap-2 Maneuver	-	-	-	-	-
Stage 1	-	-	-	-	-
Stage 2	-	-	-	-	-

**Approach**

	WB	NB	SB
HCM Control Delay, s	38.7	0	0
HCM LOS	E		

**Minor Lane/Major Mvmt**

	NBT	NBRWBLn1	SBT
Capacity (veh/h)	-	-	138
HCM Lane V/C Ratio	-	-	0.229
HCM Control Delay (s)	-	-	38.7
HCM Lane LOS	-	-	E
HCM 95th %tile Q(veh)	-	-	0.8





## **Synchro™ Output - 2026 Background Plus Site-Generated Traffic – Phase 1**

Pepper Square TIA  
Lanes, Volumes, Timings

Phase 1 - 2026 Background + Site - AM  
4: Berry Trail & Belt Line

	←	→	↖	↗	←	→	↖	↗	←	→	↖	↗
Lane Group	EBL	EBT	EBR	WBL	WBT	WBR	NBL	NBT	NBR	SBL	SBT	SBR
Lane Configurations	↑↑↑		↑↑		↑↑↑↑		↑↑		↑		↑↑	
Traffic Volume (vph)	13	496	17	16	1014	22	47	1	26	35	7	63
Future Volume (vph)	13	496	17	16	1014	22	47	1	26	35	7	63
Ideal Flow (vphpl)	1900	1900	1900	1900	1900	1900	1900	1900	1900	1900	1900	1900
Storage Length (ft)	150	0	150	0	0	0	0	0	0	0	0	0
Storage Lanes	1	0	1	0	1	0	1	0	1	0	1	0
Taper Length (ft)	25		25		25		25		25		25	
Lane Util. Factor	1.00	0.91	0.91	1.00	0.91	0.91	1.00	1.00	1.00	1.00	1.00	1.00
Frt		0.995			0.997			0.855				0.865
Fit Protected	0.950			0.950			0.950			0.950		
Satd. Flow (prot)	1770	5060	0	1770	5070	0	1770	1593	0	1770	1611	0
Fit Permitted	0.206			0.413			0.690			0.736		
Satd. Flow (perm)	384	5060	0	769	5070	0	1285	1593	0	1371	1611	0
Right Turn on Red		Yes			Yes			Yes				Yes
Satd. Flow (RTOR)		5			3			31				74
Link Speed (mph)	42			42			30			30		
Link Distance (ft)	234			493			277			236		
Travel Time (s)	3.8			8.0			6.3			5.4		
Peak Hour Factor	0.85	0.85	0.85	0.85	0.85	0.85	0.85	0.85	0.85	0.85	0.85	0.85
Adj. Flow (vph)	15	584	20	19	1193	26	55	1	31	41	8	74
Shared Lane Traffic (%)												
Lane Group Flow (vph)	15	604	0	19	1219	0	55	32	0	41	82	0
Enter Blocked Intersection	No	No	No	No	No	No	No	No	No	No	No	No
Lane Alignment	Left	Left	Right	Left	Left	Right	Left	Left	Right	Left	Left	Right
Median Width(ft)	12			12			12			12		
Link Offset(ft)	0			0			0			0		
Crosswalk Width(ft)	16			16			16			16		
Two way Left Turn Lane												
Headway Factor	1.00	1.00	1.00	1.00	1.00	1.00	1.00	1.00	1.00	1.00	1.00	1.00
Turning Speed (mph)	15		9	15		9	15		9	15		9
Number of Detectors	1	2		1	2		1	2		1	2	
Detector Template	Left	Thru		Left	Thru		Left	Thru		Left	Thru	
Leading Detector (ft)	20	100		20	100		20	100		20	100	
Trailing Detector (ft)	0	0		0	0		0	0		0	0	
Detector 1 Position(ft)	0	0		0	0		0	0		0	0	
Detector 1 Size(ft)	20	6		20	6		20	6		20	6	
Detector 1 Type	Cl+Ex	Cl+Ex		Cl+Ex	Cl+Ex		Cl+Ex	Cl+Ex		Cl+Ex	Cl+Ex	
Detector 1 Channel												
Detector 1 Extend (s)	0.0	0.0		0.0	0.0		0.0	0.0		0.0	0.0	
Detector 1 Queue (s)	0.0	0.0		0.0	0.0		0.0	0.0		0.0	0.0	
Detector 1 Delay (s)	0.0	0.0		0.0	0.0		0.0	0.0		0.0	0.0	
Detector 2 Position(ft)		94			94			94			94	
Detector 2 Size(ft)		6			6			6			6	
Detector 2 Type		Cl+Ex			Cl+Ex			Cl+Ex			Cl+Ex	
Detector 2 Channel												
Detector 2 Extend (s)		0.0			0.0			0.0			0.0	
Turn Type	D,P+P	NA		D,P+P	NA		D,P+P	NA		D,P+P	NA	
Protected Phases	3	8		7	4		1	6		5	2	
Permitted Phases	4			8			2			6		

Pepper Square TIA  
Lanes, Volumes, Timings

Phase 1 - 2026 Background + Site - AM  
4: Berry Trail & Belt Line

	←	→	↖	↗	←	→	↖	↗	←	→	↖	↗
Lane Group	EBL	EBT	EBR	WBL	WBT	WBR	NBL	NBT	NBR	SBL	SBT	SBR
Detector Phase	3	8		7	4		1	6		5	2	
Switch Phase												
Minimum Initial (s)	4.0	4.0		4.0	4.0		4.0	4.0		4.0	4.0	
Minimum Split (s)	10.0	24.0		10.0	24.0		10.0	31.0		10.0	31.0	
Total Split (s)	15.0	99.0		15.0	99.0		25.0	31.0		15.0	21.0	
Total Split (%)	9.4%	61.9%		9.4%	61.9%		15.6%	19.4%		9.4%	13.1%	
Maximum Green (s)	9.0	93.0		9.0	93.0		19.0	25.0		9.0	15.0	
Yellow Time (s)	4.0	4.0		4.0	4.0		4.0	4.0		4.0	4.0	
All-Red Time (s)	2.0	2.0		2.0	2.0		2.0	2.0		2.0	2.0	
Lost Time Adjust (s)	0.0	0.0		0.0	0.0		0.0	0.0		0.0	0.0	
Total Lost Time (s)	6.0	6.0		6.0	6.0		6.0	6.0		6.0	6.0	
Lead/Lag		Lead	Lag		Lead	Lag		Lead	Lag		Lead	Lag
Lead-Lag Optimize?	Yes	Yes		Yes	Yes		Yes	Yes		Yes	Yes	
Vehicle Extension (s)	1.0	1.0		1.0	1.0		1.0	1.0		1.0	1.0	
Recall Mode	None	C-Max		None	C-Max		None	None		None	None	
Walk Time (s)		4.0			4.0			4.0			4.0	
Flash Dont Walk (s)		14.0			14.0			21.0			21.0	
Pedestrian Calls (#/hr)		0			0			0			0	
Act Effct Green (s)	127.9	124.2		126.7	126.3		12.9	7.0		12.9	5.8	
Actuated g/C Ratio	0.80	0.78		0.79	0.79		0.08	0.04		0.08	0.04	
v/c Ratio	0.04	0.15		0.03	0.30		0.43	0.32		0.32	0.64	
Control Delay	6.1	6.7		1.4	1.7		72.5	30.7		67.8	39.7	
Queue Delay	0.0	0.0		0.0	0.0		0.0	0.0		0.0	0.0	
Total Delay	6.1	6.7		1.4	1.7		72.5	30.7		67.8	39.7	
LOS	A	A		A	A		E	C		E	D	
Approach Delay		6.7			1.7			57.1			49.1	
Approach LOS		A			A			E			D	
Queue Length 50th (ft)	3	50		1	27		54	1		40	8	
Queue Length 95th (ft)	m8	63		3	57		89	34		71	58	
Internal Link Dist (ft)		154			413			197			156	
Turn Bay Length (ft)	150			150								
Base Capacity (vph)	389	3929		679	4001		229	275		152	218	
Starvation Cap Reductn	0	0		0	0		0	0		0	0	
Spillback Cap Reductn	0	0		0	0		0	0		0	0	
Storage Cap Reductn	0	0		0	0		0	0		0	0	
Reduced v/c Ratio	0.04	0.15		0.03	0.30		0.24	0.12		0.27	0.38	
Intersection Summary												
Area Type:	Other											
Cycle Length:	160											
Actuated Cycle Length:	160											
Offset:	11 (7%), Referenced to phase 4:EBWB and 8:EBWB, Start of Yellow											
Natural Cycle:	75											
Control Type:	Actuated-Coordinated											
Maximum v/c Ratio:	0.64											
Intersection Signal Delay:	8.4						Intersection LOS: A					
Intersection Capacity Utilization:	39.4%						ICU Level of Service A					
Analysis Period (min)	15											
m Volume for 95th percentile queue is metered by upstream signal.												

Pepper Square TIA  
Lanes, Volumes, Timings

Phase 1 - 2026 Background + Site - AM  
4: Berry Trail & Belt Line

Splits and Phases: 4: Berry Trail & Belt Line

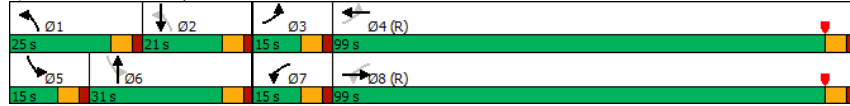

Pepper Square TIA  
Lanes, Volumes, Timings

Phase 1 - 2026 Background + Site - AM  
1335: Meadow Creek & Belt Line

	EBL	EBT	EBR	WBL	WBT	WBR	NBL	NBT	NBR	SBL	SBT	SBR
Lane Configurations	↑↑↑↑											
Traffic Volume (vph)	29	667	15	3	1078	17	21	3	6	8	9	81
Future Volume (vph)	29	667	15	3	1078	17	21	3	6	8	9	81
Ideal Flow (vphpl)	1900	1900	1900	1900	1900	1900	1900	1900	1900	1900	1900	1900
Storage Length (ft)	150		0	150		0	0		0	0		0
Storage Lanes	1		0	1		0	0		0	0		0
Taper Length (ft)	25			25			25			25		
Lane Util. Factor	1.00	0.91	0.91	1.00	0.91	0.91	1.00	1.00	1.00	1.00	1.00	1.00
Frt		0.997			0.998			0.975			0.889	
Fit Protected	0.950			0.950				0.965			0.996	
Satd. Flow (prot)	1770	5070	0	1770	5075	0	0	1753	0	0	1649	0
Fit Permitted	0.213			0.353				0.708			0.978	
Satd. Flow (perm)	397	5070	0	658	5075	0	0	1286	0	0	1620	0
Right Turn on Red			Yes			Yes			Yes			Yes
Satd. Flow (RTOR)		5			3			6			87	
Link Speed (mph)	42			42			30			30		
Link Distance (ft)		1673			2404		392			423		
Travel Time (s)		27.2			39.0		8.9			9.6		
Peak Hour Factor	0.93	0.93	0.93	0.93	0.93	0.93	0.93	0.93	0.93	0.93	0.93	0.93
Adj. Flow (vph)	31	717	16	3	1159	18	23	3	6	9	10	87
Shared Lane Traffic (%)												
Lane Group Flow (vph)	31	733	0	3	1177	0	0	32	0	0	106	0
Enter Blocked Intersection	No	No	No	No	No	No	No	No	No	No	No	No
Lane Alignment	Left	Left	Right	Left	Left	Right	Left	Left	Right	Left	Left	Right
Median Width(ft)	12			12			0			0		
Link Offset(ft)	0			0			0			0		
Crosswalk Width(ft)	16			16			16			16		
Two way Left Turn Lane												
Headway Factor	1.00	1.00	1.00	1.00	1.00	1.00	1.00	1.00	1.00	1.00	1.00	1.00
Turning Speed (mph)	15		9	15		9	15		9	15		9
Number of Detectors	1	1		1	1		1	1		1	1	
Detector Template												
Leading Detector (ft)	50	50		50	50		50	50		50	50	
Trailing Detector (ft)	0	0		0	0		0	0		0	0	
Detector 1 Position(ft)	0	0		0	0		0	0		0	0	
Detector 1 Size(ft)	50	50		50	50		50	50		50	50	
Detector 1 Type	Cl+Ex	Cl+Ex		Cl+Ex	Cl+Ex		Cl+Ex	Cl+Ex		Cl+Ex	Cl+Ex	
Detector 1 Channel												
Detector 1 Extend (s)	0.0	0.0		0.0	0.0		0.0	0.0		0.0	0.0	
Detector 1 Queue (s)	0.0	0.0		0.0	0.0		0.0	0.0		0.0	0.0	
Detector 1 Delay (s)	0.0	0.0		0.0	0.0		0.0	0.0		0.0	0.0	
Turn Type	Perm	NA		Perm	NA		Perm	NA		Perm	NA	
Protected Phases		6 14			2 10			4 12			4 12	
Permitted Phases	6 14			2 10		4 12				4 12		
Detector Phase	6 14	6 14		2 10	2 10		4 12	4 12		4 12	4 12	
Switch Phase												
Minimum Initial (s)												
Minimum Split (s)												
Total Split (s)												

Pepper Square TIA  
Lanes, Volumes, Timings

Phase 1 - 2026 Background + Site - AM  
1335: Meadow Creek & Belt Line

Lane Group	Ø2	Ø4	Ø6	Ø10	Ø12	Ø14
Lane Configurations						
Traffic Volume (vph)						
Future Volume (vph)						
Ideal Flow (vphpl)						
Storage Length (ft)						
Storage Lanes						
Taper Length (ft)						
Lane Util. Factor						
Frt						
Fit Protected						
Satd. Flow (prot)						
Fit Permitted						
Satd. Flow (perm)						
Right Turn on Red						
Satd. Flow (RTOR)						
Link Speed (mph)						
Link Distance (ft)						
Travel Time (s)						
Peak Hour Factor						
Adj. Flow (vph)						
Shared Lane Traffic (%)						
Lane Group Flow (vph)						
Enter Blocked Intersection						
Lane Alignment						
Median Width(ft)						
Link Offset(ft)						
Crosswalk Width(ft)						
Two way Left Turn Lane						
Headway Factor						
Turning Speed (mph)						
Number of Detectors						
Detector Template						
Leading Detector (ft)						
Trailing Detector (ft)						
Detector 1 Position(ft)						
Detector 1 Size(ft)						
Detector 1 Type						
Detector 1 Channel						
Detector 1 Extend (s)						
Detector 1 Queue (s)						
Detector 1 Delay (s)						
Turn Type						
Protected Phases	2	4	6	10	12	14
Permitted Phases						
Detector Phase						
Switch Phase						
Minimum Initial (s)	12.0	6.0	12.0	12.0	12.0	6.0
Minimum Split (s)	17.0	23.5	17.0	20.0	23.0	20.0
Total Split (s)	96.0	22.0	96.0	22.0	20.0	22.0

Pepper Square TIA  
Lanes, Volumes, Timings

Phase 1 - 2026 Background + Site - AM  
1335: Meadow Creek & Belt Line

Lane Group	EBL	EBT	EBR	WBL	WBT	WBR	NBL	NBT	NBR	SBL	SBT	SBR
Total Split (%)												
Maximum Green (s)												
Yellow Time (s)												
All-Red Time (s)												
Lost Time Adjust (s)												
Total Lost Time (s)												
Lead/Lag												
Lead-Lag Optimize?												
Vehicle Extension (s)												
Recall Mode												
Walk Time (s)												
Flash Dont Walk (s)												
Pedestrian Calls (#/hr)												
Act Effect Green (s)	122.1	122.1		122.1	122.1			21.9				21.9
Actuated g/C Ratio	0.76	0.76		0.76	0.76			0.14				0.14
v/c Ratio	0.10	0.19		0.01	0.30			0.18				0.36
Control Delay	1.8	1.3		0.3	0.3			39.9				15.5
Queue Delay	0.0	0.0		0.0	0.0			0.0				0.0
Total Delay	1.8	1.3		0.3	0.3			39.9				15.5
LOS	A	A		A	A			D				B
Approach Delay		1.3			0.3			39.9				15.5
Approach LOS		A			A			D				B
Queue Length 50th (ft)	1	12		0	5			21				15
Queue Length 95th (ft)	3	13		m0	m5			48				62
Internal Link Dist (ft)		1593			2324			312				343
Turn Bay Length (ft)	150			150								
Base Capacity (vph)	314	4015		521	4019			278				412
Starvation Cap Reductn	0	0		0	0			0				0
Spillback Cap Reductn	0	0		0	0			0				0
Storage Cap Reductn	0	0		0	0			0				0
Reduced v/c Ratio	0.10	0.18		0.01	0.29			0.12				0.26

Intersection Summary

Area Type: Other  
 Cycle Length: 160  
 Actuated Cycle Length: 160  
 Offset: 82 (51%), Referenced to phase 2:WBTl and 6:EBTL, Start of Yellow  
 Natural Cycle: 85  
 Control Type: Actuated-Coordinated  
 Maximum v/c Ratio: 0.36  
 Intersection Signal Delay: 2.0 Intersection LOS: A  
 Intersection Capacity Utilization 39.1% ICU Level of Service A  
 Analysis Period (min) 15  
 m Volume for 95th percentile queue is metered by upstream signal.

Splits and Phases: 1335: Meadow Creek & Belt Line

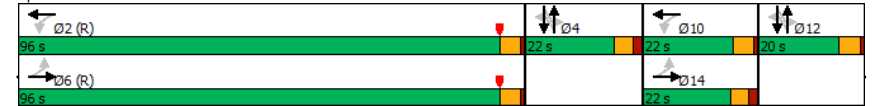

Pepper Square TIA  
Lanes, Volumes, Timings

Phase 1 - 2026 Background + Site - AM  
1335: Meadow Creek & Belt Line

Lane Group	Ø2	Ø4	Ø6	Ø10	Ø12	Ø14
Total Split (%)	60%	14%	60%	14%	13%	14%
Maximum Green (s)	91.0	16.5	91.0	17.0	15.0	16.5
Yellow Time (s)	4.0	3.7	4.0	4.0	4.0	3.7
All-Red Time (s)	1.0	1.8	1.0	1.0	1.0	1.8
Lost Time Adjust (s)						
Total Lost Time (s)						
Lead/Lag						
Lead-Lag Optimize?						
Vehicle Extension (s)	2.0	1.8	2.0	2.0	1.8	2.0
Recall Mode	C-Max	None	C-Min	None	None	None
Walk Time (s)	4.0	4.0	4.0	4.0	4.0	4.0
Flash Dont Walk (s)	8.0	14.0	8.0	8.0	14.0	8.0
Pedestrian Calls (#/hr)	0	0	0	0	0	0
Act Effect Green (s)						
Actuated g/C Ratio						
v/c Ratio						
Control Delay						
Queue Delay						
Total Delay						
LOS						
Approach Delay						
Approach LOS						
Queue Length 50th (ft)						
Queue Length 95th (ft)						
Internal Link Dist (ft)						
Turn Bay Length (ft)						
Base Capacity (vph)						
Starvation Cap Reductn						
Spillback Cap Reductn						
Storage Cap Reductn						
Reduced v/c Ratio						
<b>Intersection Summary</b>						

Pepper Square TIA  
Lanes, Volumes, Timings

Phase 1 - 2026 Background + Site - AM  
1365: Preston & Arapahoe

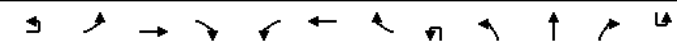

Lane Group	EBU	EBL	EBT	EBR	WBL	WBT	WBR	NBU	NBL	NBT	NBR	SBU
Lane Configurations		↔	↔		↔	↔		↔	↔	↔		
Traffic Volume (vph)	3	134	261	145	120	731	168	1	125	1690	96	4
Future Volume (vph)	3	134	261	145	120	731	168	1	125	1690	96	4
Ideal Flow (vphpl)	1900	1900	1900	1900	1900	1900	1900	1900	1900	1900	1900	1900
Storage Length (ft)		150		0	150		0		300		0	
Storage Lanes		2		0	2		0		2		0	
Taper Length (ft)		25			25				25			
Lane Util. Factor	0.91	0.97	0.91	0.91	0.97	0.91	0.91	0.91	0.97	0.91	0.91	0.91
Frt			0.946			0.972				0.992		
Fit Protected		0.950			0.950				0.950			
Satd. Flow (prot)	0	3433	4811	0	3433	4943	0	0	3433	5045	0	0
Fit Permitted		0.950			0.950				0.950			
Satd. Flow (perm)	0	3433	4811	0	3433	4943	0	0	3433	5045	0	0
Right Turn on Red			Yes			Yes				Yes		
Satd. Flow (RTOR)			84			33				7		
Link Speed (mph)		42			42				42			
Link Distance (ft)		1672			1942				3054			
Travel Time (s)		27.1			31.5				49.6			
Peak Hour Factor	0.95	0.95	0.95	0.95	0.95	0.95	0.95	0.95	0.95	0.95	0.95	0.95
Adj. Flow (vph)	3	141	275	153	126	769	177	1	132	1779	101	4
Shared Lane Traffic (%)												
Lane Group Flow (vph)	0	144	428	0	126	946	0	0	133	1880	0	0
Enter Blocked Intersection	No	No	No	No	No	No	No	No	No	No	No	No
Lane Alignment	R NA	Left	Left	Right	Left	Left	Right	R NA	Left	Left	Right	R NA
Median Width(ft)		24			24				24			
Link Offset(ft)		0			0				0			
Crosswalk Width(ft)			16			16				16		
Two way Left Turn Lane												
Headway Factor	1.00	1.00	1.00	1.00	1.00	1.00	1.00	1.00	1.00	1.00	1.00	1.00
Turning Speed (mph)	9	15		9	15		9	15		9	15	9
Number of Detectors	1	1	1		1	1		1	1	1		1
Detector Template												
Leading Detector (ft)	50	50	50		50	50		50	50	50		50
Trailing Detector (ft)	0	0	0		0	0		0	0	0		0
Detector 1 Position(ft)	0	0	0		0	0		0	0	0		0
Detector 1 Size(ft)	50	50	50		50	50		50	50	50		50
Detector 1 Type	CI+Ex	CI+Ex	CI+Ex		CI+Ex	CI+Ex		CI+Ex	CI+Ex	CI+Ex		CI+Ex
Detector 1 Channel												
Detector 1 Extend (s)	0.0	0.0	0.0		0.0	0.0		0.0	0.0	0.0		0.0
Detector 1 Queue (s)	0.0	0.0	0.0		0.0	0.0		0.0	0.0	0.0		0.0
Detector 1 Delay (s)	0.0	0.0	0.0		0.0	0.0		0.0	0.0	0.0		0.0
Turn Type	Prot	Prot	NA		Prot	NA		Prot	Prot	NA		Prot
Protected Phases	3	3	8		7	4		1	1	6		5
Permitted Phases												
Detector Phase	3	3	8		7	4		1	1	6		5
Switch Phase												
Minimum Initial (s)	3.0	3.0	18.0		3.0	18.0		3.0	3.0	18.0		3.0
Minimum Split (s)	10.0	10.0	36.7		21.0	36.3		10.0	10.0	35.7		10.0
Total Split (s)	13.0	13.0	44.0		18.0	49.0		14.0	14.0	78.0		20.0

Pepper Square TIA  
Lanes, Volumes, Timings

Phase 1 - 2026 Background + Site - AM  
1365: Preston & Arapaho

Lane Group	SBL	SBT	SBR
Lane Configurations	↑↑	↑↑↑	
Traffic Volume (vph)	100	1824	216
Future Volume (vph)	100	1824	216
Ideal Flow (vphpl)	1900	1900	1900
Storage Length (ft)	250		0
Storage Lanes	2		0
Taper Length (ft)	25		
Lane Util. Factor	0.97	0.91	0.91
Frt		0.984	
Fit Protected	0.950		
Satd. Flow (prot)	3433	5004	0
Fit Permitted	0.950		
Satd. Flow (perm)	3433	5004	0
Right Turn on Red			Yes
Satd. Flow (RTOR)		18	
Link Speed (mph)		48	
Link Distance (ft)		5087	
Travel Time (s)		72.3	
Peak Hour Factor	0.95	0.95	0.95
Adj. Flow (vph)	105	1920	227
Shared Lane Traffic (%)			
Lane Group Flow (vph)	109	2147	0
Enter Blocked Intersection	No	No	No
Lane Alignment	Left	Left	Right
Median Width(ft)		24	
Link Offset(ft)		0	
Crosswalk Width(ft)		16	
Two way Left Turn Lane			
Headway Factor	1.00	1.00	1.00
Turning Speed (mph)	15		9
Number of Detectors	1	1	
Detector Template			
Leading Detector (ft)	50	50	
Trailing Detector (ft)	0	0	
Detector 1 Position(ft)	0	0	
Detector 1 Size(ft)	50	50	
Detector 1 Type	CI+Ex	CI+Ex	
Detector 1 Channel			
Detector 1 Extend (s)	0.0	0.0	
Detector 1 Queue (s)	0.0	0.0	
Detector 1 Delay (s)	0.0	0.0	
Turn Type	Prot	NA	
Protected Phases	5	2	
Permitted Phases			
Detector Phase	5	2	
Switch Phase			
Minimum Initial (s)	3.0	18.0	
Minimum Split (s)	10.0	37.7	
Total Split (s)	20.0	84.0	

Pepper Square TIA  
Lanes, Volumes, Timings

Phase 1 - 2026 Background + Site - AM  
1365: Preston & Arapaho

Lane Group	EBU	EBL	EBT	EBR	WBL	WBT	WBR	NBU	NBL	NBT	NBR	SBU
Total Split (%)	8.1%	8.1%	27.5%		11.3%	30.6%		8.8%	8.8%	48.8%		12.5%
Maximum Green (s)	7.5	7.5	38.7		12.5	43.7		8.5	8.5	72.3		14.5
Yellow Time (s)	3.0	3.0	4.3		3.0	4.3		3.0	3.0	4.7		3.0
All-Red Time (s)	2.5	2.5	1.0		2.5	1.0		2.5	2.5	1.0		2.5
Lost Time Adjust (s)		-1.0	-1.4		-1.0	-1.0			-1.0	-1.7		
Total Lost Time (s)		4.5	3.9		4.5	4.3			4.5	4.0		
Lead/Lag	Lead	Lead	Lag		Lead	Lag		Lead	Lead	Lead		Lag
Lead-Lag Optimize?	Yes	Yes	Yes		Yes	Yes		Yes	Yes	Yes		Yes
Vehicle Extension (s)	0.8	0.8	2.5		0.8	1.8		1.5	1.5	1.7		1.5
Recall Mode	None	None	Max		None	None		None	None	Max		None
Walk Time (s)			4.0			4.0				4.0		
Flash Dont Walk (s)			27.0			27.0				26.0		
Pedestrian Calls (#/hr)			0			0				0		
Act Effect Green (s)		8.4	43.5		10.1	44.8			9.2	74.0		
Actuated g/C Ratio		0.05	0.27		0.06	0.28			0.06	0.46		
v/c Ratio		0.80	0.31		0.58	0.67			0.68	0.80		
Control Delay		102.0	37.2		78.7	61.9			85.6	25.4		
Queue Delay		0.0	0.0		0.0	0.0			0.0	0.0		
Total Delay		102.0	37.2		78.7	61.9			85.6	25.4		
LOS		F	D		E	E			F	C		
Approach Delay			53.5			63.9				29.3		
Approach LOS			D			E				C		
Queue Length 50th (ft)		77	105		67	352			63	674		
Queue Length 95th (ft)		#137	139		103	414			m94	744		
Internal Link Dist (ft)			1592			1862				2974		
Turn Bay Length (ft)		150			150				300			
Base Capacity (vph)		182	1369		289	1407			203	2337		
Starvation Cap Reductn		0	0		0	0			0	0		
Spillback Cap Reductn		0	0		0	0			0	0		
Storage Cap Reductn		0	0		0	0			0	0		
Reduced v/c Ratio		0.79	0.31		0.44	0.67			0.66	0.80		

Intersection Summary

Area Type: Other  
 Cycle Length: 160  
 Actuated Cycle Length: 160  
 Offset: 11 (7%), Referenced to phase 2:SBT, Start of Yellow  
 Natural Cycle: 120  
 Control Type: Actuated-Coordinated  
 Maximum v/c Ratio: 0.85  
 Intersection Signal Delay: 44.8  
 Intersection LOS: D  
 Intersection Capacity Utilization 79.8%  
 ICU Level of Service D  
 Analysis Period (min) 15  
 # 95th percentile volume exceeds capacity, queue may be longer.  
 Queue shown is maximum after two cycles.  
 m Volume for 95th percentile queue is metered by upstream signal.

Splits and Phases: 1365: Preston & Arapaho

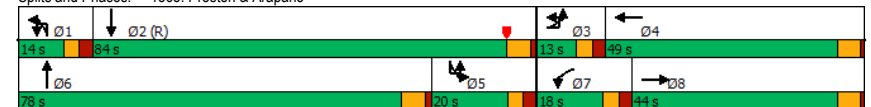

Pepper Square TIA  
Lanes, Volumes, Timings

Phase 1 - 2026 Background + Site - AM  
1365: Preston & Arapaho

Lane Group	SBL	SBT	SBR
Total Split (%)	12.5%	52.5%	
Maximum Green (s)	14.5	78.3	
Yellow Time (s)	3.0	4.7	
All-Red Time (s)	2.5	1.0	
Lost Time Adjust (s)	-1.0	-1.7	
Total Lost Time (s)	4.5	4.0	
Lead/Lag	Lag	Lag	
Lead-Lag Optimize?	Yes	Yes	
Vehicle Extension (s)	1.5	1.5	
Recall Mode	None	C-Max	
Walk Time (s)		4.0	
Flash Dont Walk (s)		28.0	
Pedestrian Calls (#/hr)		0	
Act Effect Green (s)	15.5	80.3	
Actuated g/C Ratio	0.10	0.50	
v/c Ratio	0.33	0.85	
Control Delay	79.2	45.6	
Queue Delay	0.0	0.0	
Total Delay	79.2	45.6	
LOS	E	D	
Approach Delay		47.3	
Approach LOS		D	
Queue Length 50th (ft)	55	758	
Queue Length 95th (ft)	m69	849	
Internal Link Dist (ft)		5007	
Turn Bay Length (ft)	250		
Base Capacity (vph)	332	2521	
Starvation Cap Reductn	0	0	
Spillback Cap Reductn	0	0	
Storage Cap Reductn	0	0	
Reduced v/c Ratio	0.33	0.85	

Intersection Summary

Pepper Square TIA  
Lanes, Volumes, Timings

Phase 1 - 2026 Background + Site - AM  
1367: Preston & Belt Line

Lane Group	EBU	EBL	EBT	EBR	WBL	WBT	WBR	NBL	NBT	NBR	SBU	SBL
Lane Configurations		↑↑	↑↑↑	↑	↑	↑↑↑	↑	↑↑	↑↑↑	↑		↑
Traffic Volume (vph)	10	148	400	215	81	854	139	256	1577	22	2	137
Future Volume (vph)	10	148	400	215	81	854	139	256	1577	22	2	137
Ideal Flow (vphpl)	1900	1900	1900	1900	1900	1900	1900	1900	1900	1900	1900	1900
Storage Length (ft)		150		150	200		0	250		0		200
Storage Lanes		2		1	1		0	2		0		1
Taper Length (ft)		25			25			25				25
Lane Util. Factor	0.91	0.97	0.91	1.00	1.00	0.91	0.91	0.97	0.91	0.91	0.91	1.00
Fit			0.850		0.979			0.998				
Fit Protected		0.950		0.950		0.950		0.950				0.950
Satd. Flow (prot)	0	3433	5085	1583	1770	4979	0	3433	5075	0	0	1770
Fit Permitted		0.950		0.950		0.950		0.950				0.950
Satd. Flow (perm)	0	3433	5085	1583	1770	4979	0	3433	5075	0	0	1770
Right Turn on Red				Yes		Yes			Yes		Yes	
Satd. Flow (RTOR)				196		19			2			
Link Speed (mph)			42			42			42			
Link Distance (ft)			925			394			261			
Travel Time (s)			15.0			6.4			4.2			
Peak Hour Factor	0.95	0.95	0.95	0.95	0.95	0.95	0.95	0.95	0.95	0.95	0.95	0.95
Adj. Flow (vph)	11	156	421	226	85	899	146	269	1660	23	2	144
Shared Lane Traffic (%)												
Lane Group Flow (vph)	0	167	421	226	85	1045	0	269	1683	0	0	146
Enter Blocked Intersection	No	No	No	No	No	No	No	No	No	No	No	No
Lane Alignment	R NA	Left	Left	Right	Left	Left	Right	Left	Left	Right	R NA	Left
Median Width(ft)			24			24			24			
Link Offset(ft)			0			0			0			
Crosswalk Width(ft)				16		16			16			
Two way Left Turn Lane												
Headway Factor	1.00	1.00	1.00	1.00	1.00	1.00	1.00	1.00	1.00	1.00	1.00	1.00
Turning Speed (mph)	9	15		9	15		9	15		9	9	15
Number of Detectors	1	1	1	1	1	1	1	1	1	1	1	1
Detector Template												
Leading Detector (ft)	50	50	50	50	50	50		50	50		50	50
Trailing Detector (ft)	0	0	0	0	0	0		0	0		0	0
Detector 1 Position(ft)	0	0	0	0	0	0		0	0		0	0
Detector 1 Size(ft)	50	50	50	50	50	50		50	50		50	50
Detector 1 Type	Cl+Ex	Cl+Ex	Cl+Ex	Cl+Ex	Cl+Ex	Cl+Ex		Cl+Ex	Cl+Ex		Cl+Ex	Cl+Ex
Detector 1 Channel												
Detector 1 Extend (s)	0.0	0.0	0.0	0.0	0.0	0.0		0.0	0.0		0.0	0.0
Detector 1 Queue (s)	0.0	0.0	0.0	0.0	0.0	0.0		0.0	0.0		0.0	0.0
Detector 1 Delay (s)	0.0	0.0	0.0	0.0	0.0	0.0		0.0	0.0		0.0	0.0
Turn Type	Prot	Prot	NA	Perm	Prot	NA		Prot	NA		Prot	Prot
Protected Phases	3	3	8		7	4		1	6		5	5
Permitted Phases				8								
Detector Phase	3	3	8	8	7	4		1	6		5	5
Switch Phase												
Minimum Initial (s)	3.0	3.0	18.0	18.0	3.0	18.0		3.0	18.0		3.0	3.0
Minimum Split (s)	11.0	11.0	32.5	32.5	8.0	32.5		8.0	33.0		11.0	11.0
Total Split (s)	16.0	16.0	42.0	42.0	20.0	46.0		18.0	76.0		22.0	22.0

Pepper Square TIA  
Lanes, Volumes, Timings

Phase 1 - 2026 Background + Site - AM  
1367: Preston & Belt Line

Lane Group	SBT	SBR
Lane Configurations	↑↑↑	↑
Traffic Volume (vph)	1752	241
Future Volume (vph)	1752	241
Ideal Flow (vphpl)	1900	1900
Storage Length (ft)	300	
Storage Lanes	1	
Taper Length (ft)		
Lane Util. Factor	0.91	1.00
Frt	0.850	
Fit Protected		
Satd. Flow (prot)	5085	1583
Fit Permitted		
Satd. Flow (perm)	5085	1583
Right Turn on Red	Yes	
Satd. Flow (RTOR)	181	
Link Speed (mph)	40	
Link Distance (ft)	3054	
Travel Time (s)	52.1	
Peak Hour Factor	0.95	0.95
Adj. Flow (vph)	1844	254
Shared Lane Traffic (%)		
Lane Group Flow (vph)	1844	254
Enter Blocked Intersection	No	No
Lane Alignment	Left	Right
Median Width(ft)	24	
Link Offset(ft)	0	
Crosswalk Width(ft)	16	
Two way Left Turn Lane		
Headway Factor	1.00	1.00
Turning Speed (mph)	9	
Number of Detectors	1	1
Detector Template		
Leading Detector (ft)	50	50
Trailing Detector (ft)	0	0
Detector 1 Position(ft)	0	0
Detector 1 Size(ft)	50	50
Detector 1 Type	CI+Ex	CI+Ex
Detector 1 Channel		
Detector 1 Extend (s)	0.0	0.0
Detector 1 Queue (s)	0.0	0.0
Detector 1 Delay (s)	0.0	0.0
Turn Type	NA	Perm
Protected Phases	2	
Permitted Phases	2	
Detector Phase	2	2
Switch Phase		
Minimum Initial (s)	18.0	18.0
Minimum Split (s)	33.0	33.0
Total Split (s)	80.0	80.0

09/22/2022 11:11 am  
Kimley-Horn

Synchro 11 Report  
Page 13

Pepper Square TIA  
Lanes, Volumes, Timings

Phase 1 - 2026 Background + Site - AM  
1367: Preston & Belt Line

Lane Group	EBU	EBL	EBT	EBR	WBL	WBT	WBR	NBL	NBT	NBR	SBU	SBL
Total Split (%)	10.0%	10.0%	26.3%	26.3%	12.5%	28.8%		11.3%	47.5%		13.8%	13.8%
Maximum Green (s)	11.0	11.0	36.5	36.5	15.0	40.5		13.0	70.0		17.0	17.0
Yellow Time (s)	3.0	3.0	4.0	4.0	3.0	4.0		3.0	4.4		3.0	3.0
All-Red Time (s)	2.0	2.0	1.5	1.5	2.0	1.5		2.0	1.6		2.0	2.0
Lost Time Adjust (s)		-1.0	-1.5	-1.5	-1.0	-1.5		-1.0	-1.7			-1.0
Total Lost Time (s)		4.0	4.0	4.0	4.0	4.0		4.0	4.3			4.0
Lead/Lag	Lead	Lead	Lead	Lead	Lag	Lag		Lag	Lag		Lead	Lead
Lead-Lag Optimize?	Yes	Yes	Yes	Yes	Yes	Yes		Yes	Yes		Yes	Yes
Vehicle Extension (s)	1.3	1.3	1.3	1.3	1.0	1.3		1.6	2.0		1.5	1.5
Recall Mode	None	None	Max	Max	None	Max		None	C-Max		None	None
Walk Time (s)			7.0	7.0		7.0			7.0			
Flash Dont Walk (s)			20.0	20.0		20.0			20.0			
Pedestrian Calls (#/hr)			0	0		0			0			
Act Effect Green (s)		11.2	38.0	38.0	16.0	42.8		14.0	73.3			16.4
Actuated g/C Ratio		0.07	0.24	0.24	0.10	0.27		0.09	0.46			0.10
v/c Ratio		0.70	0.35	0.43	0.48	0.78		0.90	0.72			0.81
Control Delay		74.2	41.3	10.4	49.7	29.9		90.4	26.2			104.7
Queue Delay		0.0	0.0	0.0	0.0	0.0		0.0	0.8			0.0
Total Delay		74.2	41.3	10.4	49.7	29.9		90.4	27.0			104.7
LOS		E	D	B	D	C		F	C			F
Approach Delay			39.4			31.4			35.7			
Approach LOS			D			C			D			
Queue Length 50th (ft)		89	141	81	84	331		151	521			136
Queue Length 95th (ft)		132	179	143	153	424		#237	716			m177
Internal Link Dist (ft)			845			314			181			
Turn Bay Length (ft)		150		150	200			250				200
Base Capacity (vph)		257	1207	525	177	1347		300	2327			199
Starvation Cap Reductn		0	0	0	0	0		0	327			0
Spillback Cap Reductn		0	0	0	0	0		0	0			0
Storage Cap Reductn		0	0	0	0	0		0	0			0
Reduced v/c Ratio		0.65	0.35	0.43	0.48	0.78		0.90	0.84			0.73

Intersection Summary

Area Type: Other  
 Cycle Length: 160  
 Actuated Cycle Length: 160  
 Offset: 81 (51%), Referenced to phase 6:NBT, Start of Yellow  
 Natural Cycle: 90  
 Control Type: Actuated-Coordinated  
 Maximum v/c Ratio: 0.90  
 Intersection Signal Delay: 29.0  
 Intersection LOS: C  
 Intersection Capacity Utilization 78.8%  
 ICU Level of Service D  
 Analysis Period (min) 15  
 # 95th percentile volume exceeds capacity, queue may be longer.  
 Queue shown is maximum after two cycles.  
 m Volume for 95th percentile queue is metered by upstream signal.

Splits and Phases: 1367: Preston & Belt Line

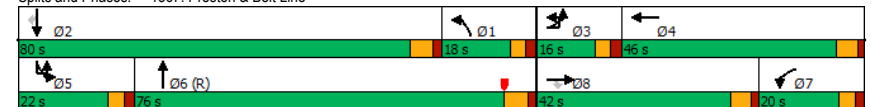



Pepper Square TIA  
Lanes, Volumes, Timings

Phase 1 - 2026 Background + Site - AM  
1367: Preston & Belt Line

Lane Group	SBT	SBR
Total Split (%)	50.0%	50.0%
Maximum Green (s)	74.0	74.0
Yellow Time (s)	4.4	4.4
All-Red Time (s)	1.6	1.6
Lost Time Adjust (s)	-1.7	-1.7
Total Lost Time (s)	4.3	4.3
Lead/Lag	Lead	Lead
Lead-Lag Optimize?	Yes	Yes
Vehicle Extension (s)	2.5	2.5
Recall Mode	Max	Max
Walk Time (s)	7.0	7.0
Flash Dont Walk (s)	20.0	20.0
Pedestrian Calls (#/hr)	0	0
Act Effect Green (s)	75.7	75.7
Actuated g/C Ratio	0.47	0.47
v/c Ratio	0.77	0.30
Control Delay	13.8	0.9
Queue Delay	0.0	0.0
Total Delay	13.8	0.9
LOS	B	A
Approach Delay	18.3	
Approach LOS	B	
Queue Length 50th (ft)	312	0
Queue Length 95th (ft)	293	m3
Internal Link Dist (ft)	2974	
Turn Bay Length (ft)		300
Base Capacity (vph)	2405	844
Starvation Cap Reductn	0	0
Spillback Cap Reductn	0	0
Storage Cap Reductn	0	0
Reduced v/c Ratio	0.77	0.30

Intersection Summary

Pepper Square TIA  
Lanes, Volumes, Timings

Phase 1 - 2026 Background + Site - AM  
1368: Preston & Alexis

Lane Group	EBL	EBT	EBR	WBL	WBT	WBR	NBU	NBL	NBT	NBR	SBL	SBT
Lane Configurations												
Traffic Volume (vph)	15	5	28	189	22	66	3	21	1835	108	88	1917
Future Volume (vph)	15	5	28	189	22	66	3	21	1835	108	88	1917
Ideal Flow (vphpl)	1900	1900	1900	1900	1900	1900	1900	1900	1900	1900	1900	1900
Storage Length (ft)	0		0	175		0		150		150	150	
Storage Lanes	1		1	2		1		1		1	1	
Taper Length (ft)	25			25				25			25	
Lane Util. Factor	0.91	0.91	1.00	0.97	1.00	1.00	0.91	1.00	0.91	1.00	1.00	0.91
Frt			0.850			0.850				0.850		
Fit Protected	0.950	0.970		0.950				0.950			0.950	
Satd. Flow (prot)	1610	3288	1583	3433	1863	1583	0	1770	5085	1583	1770	5085
Fit Permitted	0.950	0.970		0.950				0.068			0.069	
Satd. Flow (perm)	1610	3288	1583	3433	1863	1583	0	127	5085	1583	129	5085
Right Turn on Red			Yes			Yes			Yes			Yes
Satd. Flow (RTOR)			125			85					89	
Link Speed (mph)		30			30			43				42
Link Distance (ft)		660			627			2867				173
Travel Time (s)		15.0			14.3			45.5				2.8
Peak Hour Factor	0.92	0.92	0.92	0.92	0.92	0.92	0.92	0.92	0.92	0.92	0.92	0.92
Adj. Flow (vph)	16	5	30	205	24	72	3	23	1995	117	96	2084
Shared Lane Traffic (%)		50%										
Lane Group Flow (vph)	8	13	30	205	24	72	0	26	1995	117	96	2084
Enter Blocked Intersection	No	No	No	No	No	No	No	No	No	No	No	No
Lane Alignment	Left	Left	Right	Left	Left	Right	R NA	Left	Left	Right	Left	Left
Median Width(ft)		24			24			12				12
Link Offset(ft)		0			0			0				0
Crosswalk Width(ft)		16			16			16				16
Two way Left Turn Lane												
Headway Factor	1.00	1.00	1.00	1.00	1.00	1.00	1.00	1.00	1.00	1.00	1.00	1.00
Turning Speed (mph)	15		9	15		9	9	15		9	15	
Number of Detectors	1	1	1	1	1	1	1	1	1	1	1	1
Detector Template												
Leading Detector (ft)	50	50	50	50	50	50	50	50	50	50	50	50
Trailing Detector (ft)	0	0	0	0	0	0	0	0	0	0	0	0
Detector 1 Position(ft)	0	0	0	0	0	0	0	0	0	0	0	0
Detector 1 Size(ft)	50	50	50	50	50	50	50	50	50	50	50	50
Detector 1 Type	CI+Ex	CI+Ex	CI+Ex	CI+Ex	CI+Ex	CI+Ex	CI+Ex	CI+Ex	CI+Ex	CI+Ex	CI+Ex	CI+Ex
Detector 1 Channel												
Detector 1 Extend (s)	0.0	0.0	0.0	0.0	0.0	0.0	0.0	0.0	0.0	0.0	0.0	0.0
Detector 1 Queue (s)	0.0	0.0	0.0	0.0	0.0	0.0	0.0	0.0	0.0	0.0	0.0	0.0
Detector 1 Delay (s)	0.0	0.0	0.0	0.0	0.0	0.0	0.0	0.0	0.0	0.0	0.0	0.0
Turn Type	Split	NA	Perm	Split	NA	pm+ov	custom	D,P+P	NA	Perm	D,P+P	NA
Protected Phases	3	3		4	4	5		1	6		5	2
Permitted Phases			3			4	1	2		6		6
Detector Phase	3	3	3	4	4	5	1	1	6	6	5	2
Switch Phase												
Minimum Initial (s)	6.0	6.0	6.0	8.0	8.0	3.0	3.0	3.0	14.0	14.0	3.0	14.0
Minimum Split (s)	27.0	27.0	27.0	27.0	27.0	8.4	8.4	8.4	24.0	24.0	8.4	24.0
Total Split (s)	13.0	13.0	13.0	29.0	29.0	15.0	18.0	18.0	103.0	103.0	15.0	100.0

Pepper Square TIA  
Lanes, Volumes, Timings

Phase 1 - 2026 Background + Site - AM  
1368: Preston & Alexis

Lane Group	SBR
Link Configurations	↖ ↗ ↘ ↙ ↕
Traffic Volume (vph)	23
Future Volume (vph)	23
Ideal Flow (vphpl)	1900
Storage Length (ft)	150
Storage Lanes	1
Taper Length (ft)	
Lane Util. Factor	1.00
Frt	0.850
Fit Protected	
Satd. Flow (prot)	1583
Fit Permitted	
Satd. Flow (perm)	1583
Right Turn on Red	Yes
Satd. Flow (RTOR)	78
Link Speed (mph)	
Link Distance (ft)	
Travel Time (s)	
Peak Hour Factor	0.92
Adj. Flow (vph)	25
Shared Lane Traffic (%)	
Lane Group Flow (vph)	25
Enter Blocked Intersection	No
Lane Alignment	Right
Median Width(ft)	
Link Offset(ft)	
Crosswalk Width(ft)	
Two way Left Turn Lane	
Headway Factor	1.00
Turning Speed (mph)	9
Number of Detectors	1
Detector Template	
Leading Detector (ft)	50
Trailing Detector (ft)	0
Detector 1 Position(ft)	0
Detector 1 Size(ft)	50
Detector 1 Type	CI+Ex
Detector 1 Channel	
Detector 1 Extend (s)	0.0
Detector 1 Queue (s)	0.0
Detector 1 Delay (s)	0.0
Turn Type	Perm
Protected Phases	
Permitted Phases	2
Detector Phase	2
Switch Phase	
Minimum Initial (s)	14.0
Minimum Split (s)	24.0
Total Split (s)	100.0

Pepper Square TIA  
Lanes, Volumes, Timings

Phase 1 - 2026 Background + Site - AM  
1368: Preston & Alexis

Lane Group	EBL	EBT	EBR	WBL	WBT	WBR	NBU	NBL	NBT	NBR	SBL	SBT
Total Split (%)	8.1%	8.1%	8.1%	18.1%	18.1%	9.4%	11.3%	11.3%	64.4%	64.4%	9.4%	62.5%
Maximum Green (s)	8.0	8.0	8.0	24.0	24.0	10.6	13.6	13.6	97.0	97.0	10.6	94.0
Yellow Time (s)	4.0	4.0	4.0	4.0	4.0	3.4	3.4	3.4	4.5	4.5	3.4	4.5
All-Red Time (s)	1.0	1.0	1.0	1.0	1.0	1.0	1.0	1.0	1.5	1.5	1.0	1.5
Lost Time Adjust (s)	-1.0	-1.0	0.0	-1.0	-1.0	0.0			-1.0	-2.0	0.0	-1.0
Total Lost Time (s)	4.0	4.0	5.0	4.0	4.0	4.4			3.4	4.0	6.0	3.4
Lead/Lag	Lead	Lead	Lead	Lag	Lag	Lag	Lead	Lead	Lead	Lead	Lag	Lag
Lead-Lag Optimize?	Yes	Yes	Yes	Yes	Yes	Yes	Yes	Yes	Yes	Yes	Yes	Yes
Vehicle Extension (s)	2.0	2.0	2.0	2.0	2.0	1.2	1.2	1.2	2.5	2.5	1.2	2.5
Recall Mode	None	None	None	None	None	None	None	None	Max	Max	None	C-Max
Walk Time (s)	4.0	4.0	4.0	4.0	4.0				4.0	4.0		4.0
Flash Dont Walk (s)	18.0	18.0	18.0	18.0	18.0				14.0	14.0		14.0
Pedestrian Calls (#/hr)	0	0	0	0	0				0	0		0
Act Effect Green (s)	7.2	7.2	6.2	14.9	14.9	26.0		126.7	113.1	111.1	125.3	122.8
Actuated g/C Ratio	0.04	0.04	0.04	0.09	0.09	0.16		0.79	0.71	0.69	0.78	0.77
v/c Ratio	0.11	0.09	0.17	0.64	0.14	0.22		0.17	0.56	0.10	0.44	0.53
Control Delay	76.7	74.5	2.0	79.1	67.0	7.2		4.5	6.0	0.5	17.2	1.2
Queue Delay	0.0	0.0	0.0	0.0	0.0	0.0		0.0	0.0	0.0	0.0	0.0
Total Delay	76.7	74.5	2.0	79.1	67.0	7.2		4.5	6.0	0.5	17.2	1.2
LOS	E	E	A	E	E	A		A	A	A	B	A
Approach Delay		32.2			60.9				5.7			1.9
Approach LOS		C			E				A			A
Queue Length 50th (ft)	8	7	0	108	24	0		2	231	0	27	23
Queue Length 95th (ft)	30	20	0	150	54	30		6	210	0	73	29
Internal Link Dist (ft)		580			547				2787			93
Turn Bay Length (ft)				175				150		150		
Base Capacity (vph)	90	184	197	536	291	328		252	3594	1126	220	3902
Starvation Cap Reductn	0	0	0	0	0	0		0	0	0	0	215
Spillback Cap Reductn	0	0	0	0	0	0		0	0	0	0	0
Storage Cap Reductn	0	0	0	0	0	0		0	0	0	0	0
Reduced v/c Ratio	0.09	0.07	0.15	0.38	0.08	0.22		0.10	0.56	0.10	0.44	0.57

Intersection Summary

Area Type: Other  
 Cycle Length: 160  
 Actuated Cycle Length: 160  
 Offset: 89 (56%), Referenced to phase 2:NBSB, Start of Yellow  
 Natural Cycle: 110  
 Control Type: Actuated-Coordinated  
 Maximum v/c Ratio: 0.64  
 Intersection Signal Delay: 7.8 Intersection LOS: A  
 Intersection Capacity Utilization 66.2% ICU Level of Service C  
 Analysis Period (min) 15  
 m Volume for 95th percentile queue is metered by upstream signal.

Splits and Phases: 1368: Preston & Alexis

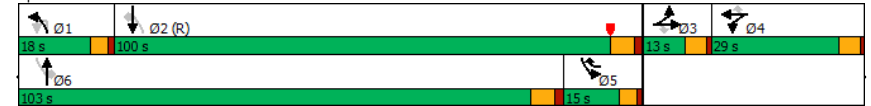

Pepper Square TIA  
Lanes, Volumes, Timings

Phase 1 - 2026 Background + Site - AM  
1368: Preston & Alexis

Lane Group	SBR
Total Split (%)	62.5%
Maximum Green (s)	94.0
Yellow Time (s)	4.5
All-Red Time (s)	1.5
Lost Time Adjust (s)	0.0
Total Lost Time (s)	6.0
Lead/Lag	Lag
Lead-Lag Optimize?	Yes
Vehicle Extension (s)	2.5
Recall Mode	C-Max
Walk Time (s)	4.0
Flash Dont Walk (s)	14.0
Pedestrian Calls (#/hr)	0
Act Effect Green (s)	120.8
Actuated g/C Ratio	0.76
v/c Ratio	0.02
Control Delay	0.0
Queue Delay	0.0
Total Delay	0.0
LOS	A
Approach Delay	
Approach LOS	
Queue Length 50th (ft)	0
Queue Length 95th (ft)	m0
Internal Link Dist (ft)	
Turn Bay Length (ft)	150
Base Capacity (vph)	1214
Starvation Cap Reductn	0
Spillback Cap Reductn	0
Storage Cap Reductn	0
Reduced v/c Ratio	0.02

Intersection Summary

Pepper Square TIA  
Lanes, Volumes, Timings

Phase 1 - 2026 Background + Site - AM  
1369: Preston & Bell Line Village Driveway

Lane Group	EBL	EBT	EBR	WBL	WBT	WBR	NBL	NBT	NBR	SBU	SBL	SBT
Lane Configurations		↕↕		↕	↕		↕↕↕	↕↕↕			↕	↕↕↕
Traffic Volume (vph)	40	1	28	4	2	0	25	1789	3	3	8	2045
Future Volume (vph)	40	1	28	4	2	0	25	1789	3	3	8	2045
Ideal Flow (vphpl)	1900	1900	1900	1900	1900	1900	1900	1900	1900	1900	1900	1900
Storage Length (ft)	0		0	0		0	100		0		100	
Storage Lanes	0		0	1		0	1		0		1	
Taper Length (ft)	25			25			25				25	
Lane Util. Factor	0.95	0.95	0.95	1.00	1.00	1.00	1.00	0.91	0.91	0.91	1.00	0.91
Fit		0.939										0.998
Fit Protected		0.972		0.950			0.950				0.950	
Satd. Flow (prot)	0	3230	0	1770	1863	0	1770	5085	0	0	1770	5075
Fit Permitted		0.808		0.705			0.052				0.072	
Satd. Flow (perm)	0	2685	0	1313	1863	0	97	5085	0	0	134	5075
Right Turn on Red			Yes			Yes			Yes			
Satd. Flow (RTOR)		31										2
Link Speed (mph)		30			30			42				38
Link Distance (ft)		303			249			252				191
Travel Time (s)		6.9			5.7			4.1				3.4
Peak Hour Factor	0.90	0.90	0.90	0.90	0.90	0.90	0.90	0.90	0.90	0.90	0.90	0.90
Adj. Flow (vph)	44	1	31	4	2	0	28	1988	3	3	9	2272
Shared Lane Traffic (%)												
Lane Group Flow (vph)	0	76	0	4	2	0	28	1991	0	0	12	2304
Enter Blocked Intersection	No	No	No	No	No	No	No	No	No	No	No	No
Lane Alignment	Left	Left	Right	Left	Left	Right	Left	Left	Right	R NA	Left	Left
Median Width(ft)		12			12			12				12
Link Offset(ft)		0			0			0				0
Crosswalk Width(ft)		16			16			16				16
Two way Left Turn Lane												
Headway Factor	1.00	1.00	1.00	1.00	1.00	1.00	1.00	1.00	1.00	1.00	1.00	1.00
Turning Speed (mph)	15		9	15		9	15		9	9	15	
Number of Detectors	1	1		1	1		1	1		1	1	1
Detector Template												
Leading Detector (ft)	50	50		50	50		50	50		50	50	50
Trailing Detector (ft)	0	0		0	0		0	0		0	0	0
Detector 1 Position(ft)	0	0		0	0		0	0		0	0	0
Detector 1 Size(ft)	50	50		50	50		50	50		50	50	50
Detector 1 Type	CI+Ex	CI+Ex		CI+Ex	CI+Ex		CI+Ex	CI+Ex		CI+Ex	CI+Ex	CI+Ex
Detector 1 Channel												
Detector 1 Extend (s)	0.0	0.0		0.0	0.0		0.0	0.0		0.0	0.0	0.0
Detector 1 Queue (s)	0.0	0.0		0.0	0.0		0.0	0.0		0.0	0.0	0.0
Detector 1 Delay (s)	0.0	0.0		0.0	0.0		0.0	0.0		0.0	0.0	0.0
Turn Type	Perm	NA		Perm	NA		D.P+P	NA		custom	D.P+P	NA
Protected Phases		8			4		1	6			5	2
Permitted Phases	8			4			2			5	6	
Detector Phase	8	8		4	4		1	6		5	5	2
Switch Phase												
Minimum Initial (s)	20.0	20.0		20.0	20.0		5.0	20.0		5.0	5.0	20.0
Minimum Split (s)	25.0	25.0		25.0	25.0		10.0	26.0		10.0	10.0	26.0
Total Split (s)	47.0	47.0		47.0	47.0		20.0	98.0		15.0	15.0	93.0

Pepper Square TIA  
Lanes, Volumes, Timings

Phase 1 - 2026 Background + Site - AM  
1369: Preston & Belt Line Village Driveway

Lane Group	SBR
Link Configurations	
Traffic Volume (vph)	29
Future Volume (vph)	29
Ideal Flow (vphpl)	1900
Storage Length (ft)	0
Storage Lanes	0
Taper Length (ft)	
Lane Util. Factor	0.91
Frnt	
Fit Protected	
Satd. Flow (prot)	0
Fit Permitted	
Satd. Flow (perm)	0
Right Turn on Red	Yes
Satd. Flow (RTOR)	
Link Speed (mph)	
Link Distance (ft)	
Travel Time (s)	
Peak Hour Factor	0.90
Adj. Flow (vph)	32
Shared Lane Traffic (%)	
Lane Group Flow (vph)	0
Enter Blocked Intersection	No
Lane Alignment	Right
Median Width(ft)	
Link Offset(ft)	
Crosswalk Width(ft)	
Two way Left Turn Lane	
Headway Factor	1.00
Turning Speed (mph)	9
Number of Detectors	
Detector Template	
Leading Detector (ft)	
Trailing Detector (ft)	
Detector 1 Position(ft)	
Detector 1 Size(ft)	
Detector 1 Type	
Detector 1 Channel	
Detector 1 Extend (s)	
Detector 1 Queue (s)	
Detector 1 Delay (s)	
Turn Type	
Protected Phases	
Permitted Phases	
Detector Phase	
Switch Phase	
Minimum Initial (s)	
Minimum Split (s)	
Total Split (s)	

Pepper Square TIA  
Lanes, Volumes, Timings

Phase 1 - 2026 Background + Site - AM  
1369: Preston & Belt Line Village Driveway

Lane Group	EBL	EBT	EBR	WBL	WBT	WBR	NBL	NBT	NBR	SBU	SBL	SBT
Total Split (%)	29.4%	29.4%		29.4%	29.4%		12.5%	61.3%		9.4%	9.4%	58.1%
Maximum Green (s)	42.3	42.3		42.3	42.3		15.0	93.7		10.0	10.0	88.7
Yellow Time (s)	3.0	3.0		3.0	3.0		3.0	3.0		3.0	3.0	3.0
All-Red Time (s)	1.7	1.7		1.7	1.7		2.0	1.3		2.0	2.0	1.3
Lost Time Adjust (s)		-1.0		-1.0	-1.0		-1.0	-2.0			-1.0	-2.0
Total Lost Time (s)		3.7		3.7	3.7		4.0	2.3			4.0	2.3
Lead/Lag							Lead	Lead		Lag	Lag	Lag
Lead-Lag Optimize?							Yes	Yes		Yes	Yes	Yes
Vehicle Extension (s)	2.0	2.0		2.0	2.0		1.5	3.0		1.5	1.5	3.3
Recall Mode	None	None		None	None		None	None		None	None	C-Max
Walk Time (s)	5.0	5.0		5.0	5.0		7.0					7.0
Flash Dont Walk (s)	15.0	15.0		15.0	15.0		8.0					8.0
Pedestrian Calls (#/hr)	0	0		0	0		0					0
Act Effect Green (s)		21.0		21.0	21.0		128.9	117.8			129.7	127.0
Actuated g/C Ratio		0.13		0.13	0.13		0.81	0.74			0.81	0.79
v/c Ratio		0.20		0.02	0.01		0.20	0.53			0.04	0.57
Control Delay		39.2		61.2	60.5		5.6	6.5			1.0	2.6
Queue Delay		0.0		0.0	0.0		0.0	0.0			0.0	0.1
Total Delay		39.2		61.2	60.5		5.6	6.6			1.0	2.6
LOS		D		E	E		A	A			A	A
Approach Delay		39.2			61.0			6.6				2.6
Approach LOS		D			E			A				A
Queue Length 50th (ft)		22		4	2		1	24			1	60
Queue Length 95th (ft)		50		17	11		m3	238			m1	69
Internal Link Dist (ft)		223			169			172				111
Turn Bay Length (ft)							100				100	
Base Capacity (vph)		749		355	504		246	3756			314	4027
Starvation Cap Reductn		0		0	0		0	130			0	332
Spillback Cap Reductn		0		0	0		0	198			0	0
Storage Cap Reductn		0		0	0		0	0			0	0
Reduced v/c Ratio		0.10		0.01	0.00		0.11	0.56			0.04	0.62

Intersection Summary

Area Type: Other  
 Cycle Length: 160  
 Actuated Cycle Length: 160  
 Offset: 86 (54%), Referenced to phase 2:NBSB, Start of Yellow  
 Natural Cycle: 70  
 Control Type: Actuated-Coordinated  
 Maximum v/c Ratio: 0.57  
 Intersection Signal Delay: 5.1  
 Intersection LOS: A  
 Intersection Capacity Utilization 63.5%  
 ICU Level of Service B  
 Analysis Period (min) 15  
 m Volume for 95th percentile queue is metered by upstream signal.

Splits and Phases: 1369: Preston & Belt Line Village Driveway



Pepper Square TIA  
Lanes, Volumes, Timings

Phase 1 - 2026 Background + Site - AM  
1369: Preston & Belt Line Village Driveway

Lane Group	SBR
Total Split (%)	
Maximum Green (s)	
Yellow Time (s)	
All-Red Time (s)	
Lost Time Adjust (s)	
Total Lost Time (s)	
Lead/Lag	
Lead-Lag Optimize?	
Vehicle Extension (s)	
Recall Mode	
Walk Time (s)	
Flash Dont Walk (s)	
Pedestrian Calls (#/hr)	
Act Effect Green (s)	
Actuated g/C Ratio	
v/c Ratio	
Control Delay	
Queue Delay	
Total Delay	
LOS	
Approach Delay	
Approach LOS	
Queue Length 50th (ft)	
Queue Length 95th (ft)	
Internal Link Dist (ft)	
Turn Bay Length (ft)	
Base Capacity (vph)	
Starvation Cap Reductn	
Spillback Cap Reductn	
Storage Cap Reductn	
Reduced v/c Ratio	
Intersection Summary	

Pepper Square TIA  
Lanes, Volumes, Timings

Phase 1 - 2026 Background + Site - AM  
1371: Preston & Spring Valley

Lane Group	EBL	EBT	EBR	WBL	WBT	WBR	NBL	NBT	NBR	SBU	SBL	SBT
Lane Configurations	↑↑	↑↑↑		↑↑	↑↑↑		↑↑	↑↑↑			↑↑	↑↑↑
Traffic Volume (vph)	151	362	250	89	729	148	114	1560	75	1	149	1989
Future Volume (vph)	151	362	250	89	729	148	114	1560	75	1	149	1989
Ideal Flow (vphpl)	1900	1900	1900	1900	1900	1900	1900	1900	1900	1900	1900	1900
Storage Length (ft)	225		0	225		0	225		0		275	
Storage Lanes	2		0	2		0	2		0		2	
Taper Length (ft)	25			25			25				25	
Lane Util. Factor	0.97	0.91	0.91	0.97	0.91	0.91	0.97	0.91	0.91	0.91	0.97	0.91
Fr		0.939			0.975			0.993				0.987
Fit Protected	0.950			0.950			0.950				0.950	
Satd. Flow (prot)	3433	4775	0	3433	4958	0	3433	5050	0	0	3433	5019
Fit Permitted	0.950			0.950			0.950				0.950	
Satd. Flow (perm)	3433	4775	0	3433	4958	0	3433	5050	0	0	3433	5019
Right Turn on Red			Yes			Yes			Yes			
Satd. Flow (RTOR)		103			26			6				15
Link Speed (mph)		38			42			41				38
Link Distance (ft)		3259			5488			2139				1208
Travel Time (s)		58.5			89.1			35.6				21.7
Peak Hour Factor	0.96	0.96	0.96	0.96	0.96	0.96	0.96	0.96	0.96	0.96	0.96	0.96
Adj. Flow (vph)	157	377	260	93	759	154	119	1625	78	1	155	2072
Shared Lane Traffic (%)												
Lane Group Flow (vph)	157	637	0	93	913	0	119	1703	0	0	156	2269
Enter Blocked Intersection	No	No	No	No	No	No	No	No	No	No	No	No
Lane Alignment	Left	Left	Right	Left	Left	Right	Left	Left	Right	R NA	Left	Left
Median Width(ft)		24			24			24				24
Link Offset(ft)		0			0			0				0
Crosswalk Width(ft)		16			16			16				16
Two way Left Turn Lane												
Headway Factor	1.00	1.00	1.00	1.00	1.00	1.00	1.00	1.00	1.00	1.00	1.00	1.00
Turning Speed (mph)	15		9	15		9	15		9	9	15	
Number of Detectors	1	1		1	1		1	1		1	1	1
Detector Template												
Leading Detector (ft)	50	50		50	50		50	50		50	50	50
Trailing Detector (ft)	0	0		0	0		0	0		0	0	0
Detector 1 Position(ft)	0	0		0	0		0	0		0	0	0
Detector 1 Size(ft)	50	50		50	50		50	50		50	50	50
Detector 1 Type	CI+Ex	CI+Ex		CI+Ex	CI+Ex		CI+Ex	CI+Ex		CI+Ex	CI+Ex	CI+Ex
Detector 1 Channel												
Detector 1 Extend (s)	0.0	0.0		0.0	0.0		0.0	0.0		0.0	0.0	0.0
Detector 1 Queue (s)	0.0	0.0		0.0	0.0		0.0	0.0		0.0	0.0	0.0
Detector 1 Delay (s)	0.0	0.0		0.0	0.0		0.0	0.0		0.0	0.0	0.0
Turn Type	Prot	NA		Prot	NA		Prot	NA		Prot	Prot	NA
Protected Phases	3	8		7	4		1	6		5	5	2
Permitted Phases												
Detector Phase	3	8		7	4		1	6		5	5	2
Switch Phase												
Minimum Initial (s)	6.0	12.0		3.0	12.0		3.0	13.0		3.0	3.0	18.0
Minimum Split (s)	11.0	27.5		11.0	27.5		11.0	28.0		11.0	11.0	28.0
Total Split (s)	15.0	43.0		16.0	44.0		13.0	71.0		30.0	30.0	88.0

Pepper Square TIA  
Lanes, Volumes, Timings

Phase 1 - 2026 Background + Site - AM  
1371: Preston & Spring Valley

Lane Group	SBR
Link Configurations	
Traffic Volume (vph)	189
Future Volume (vph)	189
Ideal Flow (vphpl)	1900
Storage Length (ft)	0
Storage Lanes	0
Taper Length (ft)	
Lane Util. Factor	0.91
Frnt	
Fit Protected	
Satd. Flow (prot)	0
Fit Permitted	
Satd. Flow (perm)	0
Right Turn on Red	Yes
Satd. Flow (RTOR)	
Link Speed (mph)	
Link Distance (ft)	
Travel Time (s)	
Peak Hour Factor	0.96
Adj. Flow (vph)	197
Shared Lane Traffic (%)	
Lane Group Flow (vph)	0
Enter Blocked Intersection	No
Lane Alignment	Right
Median Width(ft)	
Link Offset(ft)	
Crosswalk Width(ft)	
Two way Left Turn Lane	
Headway Factor	1.00
Turning Speed (mph)	9
Number of Detectors	
Detector Template	
Leading Detector (ft)	
Trailing Detector (ft)	
Detector 1 Position(ft)	
Detector 1 Size(ft)	
Detector 1 Type	
Detector 1 Channel	
Detector 1 Extend (s)	
Detector 1 Queue (s)	
Detector 1 Delay (s)	
Turn Type	
Protected Phases	
Permitted Phases	
Detector Phase	
Switch Phase	
Minimum Initial (s)	
Minimum Split (s)	
Total Split (s)	

Pepper Square TIA  
Lanes, Volumes, Timings

Phase 1 - 2026 Background + Site - AM  
1371: Preston & Spring Valley

Lane Group	EBL	EBT	EBR	WBL	WBT	WBR	NBL	NBT	NBR	SBU	SBL	SBT
Total Split (%)	9.4%	26.9%		10.0%	27.5%		8.1%	44.4%		18.8%	18.8%	55.0%
Maximum Green (s)	10.0	37.5		11.0	38.5		8.0	65.0		25.0	25.0	82.0
Yellow Time (s)	3.0	4.0		3.0	4.0		3.0	4.5		3.0	3.0	4.5
All-Red Time (s)	2.0	1.5		2.0	1.5		2.0	1.5		2.0	2.0	1.5
Lost Time Adjust (s)	-1.0	-1.5		-1.0	-1.5		-1.0	-2.0			-1.0	-2.0
Total Lost Time (s)	4.0	4.0		4.0	4.0		4.0	4.0			4.0	4.0
Lead/Lag	Lead	Lead		Lag	Lag		Lead	Lead		Lag	Lag	Lag
Lead-Lag Optimize?	Yes	Yes		Yes	Yes		Yes	Yes		Yes	Yes	Yes
Vehicle Extension (s)	0.8	2.0		0.8	2.0		0.8	2.5		0.8	0.8	2.4
Recall Mode	None	None		None	None		None	None		None	None	C-Max
Walk Time (s)		4.0			4.0			4.0				4.0
Flash Dont Walk (s)		18.0			18.0			18.0				18.0
Pedestrian Calls (#/hr)		0			0			0				0
Act Effect Green (s)	10.2	24.3		20.8	34.8		9.0	65.7			33.2	89.9
Actuated g/C Ratio	0.06	0.15		0.13	0.22		0.06	0.41			0.21	0.56
v/c Ratio	0.72	0.79		0.21	0.83		0.62	0.82			0.22	0.80
Control Delay	82.8	58.8		63.1	59.6		90.7	48.6			68.0	42.0
Queue Delay	0.0	0.0		0.0	0.0		0.0	0.0			0.0	0.0
Total Delay	82.8	58.8		63.1	59.6		90.7	48.6			68.0	42.0
LOS	F	E		E	E		F	D			E	D
Approach Delay		63.6			59.9			51.4				43.7
Approach LOS		E			E			D				D
Queue Length 50th (ft)	84	214		48	345		66	469			80	843
Queue Length 95th (ft)	125	252		m45	m320		m102	483			m115	946
Internal Link Dist (ft)		3179			5408			2059				1128
Turn Bay Length (ft)	225			225			225				275	
Base Capacity (vph)	236	1241		446	1259		205	2119			712	2827
Starvation Cap Reductn	0	0		0	0		0	0			0	0
Spillback Cap Reductn	0	0		0	0		0	0			0	0
Storage Cap Reductn	0	0		0	0		0	0			0	0
Reduced v/c Ratio	0.67	0.51		0.21	0.73		0.58	0.80			0.22	0.80

Intersection Summary

Area Type: Other  
 Cycle Length: 160  
 Actuated Cycle Length: 160  
 Offset: 156 (98%), Referenced to phase 2:SBT, Start of Yellow  
 Natural Cycle: 90  
 Control Type: Actuated-Coordinated  
 Maximum v/c Ratio: 0.83  
 Intersection Signal Delay: 51.3  
 Intersection LOS: D  
 Intersection Capacity Utilization 81.7%  
 ICU Level of Service D  
 Analysis Period (min) 15  
 m Volume for 95th percentile queue is metered by upstream signal.

Splits and Phases: 1371: Preston & Spring Valley

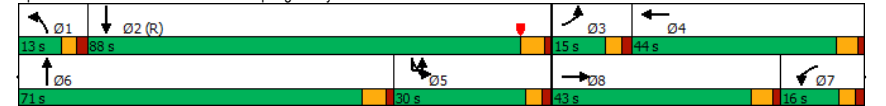

Pepper Square TIA  
Lanes, Volumes, Timings

Phase 1 - 2026 Background + Site - AM  
1371: Preston & Spring Valley

Lane Group	SBR
Total Split (%)	
Maximum Green (s)	
Yellow Time (s)	
All-Red Time (s)	
Lost Time Adjust (s)	
Total Lost Time (s)	
Lead/Lag	
Lead-Lag Optimize?	
Vehicle Extension (s)	
Recall Mode	
Walk Time (s)	
Flash Dont Walk (s)	
Pedestrian Calls (#/hr)	
Act Effect Green (s)	
Actuated g/C Ratio	
v/c Ratio	
Control Delay	
Queue Delay	
Total Delay	
LOS	
Approach Delay	
Approach LOS	
Queue Length 50th (ft)	
Queue Length 95th (ft)	
Internal Link Dist (ft)	
Turn Bay Length (ft)	
Base Capacity (vph)	
Starvation Cap Reductn	
Spillback Cap Reductn	
Storage Cap Reductn	
Reduced v/c Ratio	
Intersection Summary	

Pepper Square TIA  
Lanes, Volumes, Timings

Phase 1 - 2026 Background + Site - AM  
1405: Prestonwood & Belt Line

Lane Group	EBU	EBL	EBT	EBR	WBL	WBT	WBR	NBL	NBT	NBR	SBL	SBT
Lane Configurations		↕	↕↕		↕	↕↕			↕		↕↕	↕
Traffic Volume (vph)	4	41	741	3	4	1426	48	1	0	5	39	1
Future Volume (vph)	4	41	741	3	4	1426	48	1	0	5	39	1
Ideal Flow (vphpl)	1900	1900	1900	1900	1900	1900	1900	1900	1900	1900	1900	1900
Storage Length (ft)		200		0	200		0	0		0	300	
Storage Lanes		1		0	1		0	0		0	2	
Taper Length (ft)		25			25			25			25	
Lane Util. Factor	0.91	1.00	0.91	0.91	1.00	0.91	0.91	1.00	1.00	1.00	0.97	0.95
Fit			0.999			0.995			0.887		0.854	
Fit Protected		0.950		0.950				0.992		0.950		
Satd. Flow (prot)	0	1770	5080	0	1770	5060	0	0	1639	0	3433	1511
Fit Permitted		0.137		0.341				0.992		0.950		
Satd. Flow (perm)	0	255	5080	0	635	5060	0	0	1639	0	3433	1511
Right Turn on Red			Yes			Yes			Yes			
Satd. Flow (RTOR)			1			6			131			33
Link Speed (mph)			42			42			30			30
Link Distance (ft)			1445			2036			315			868
Travel Time (s)			23.5			33.1			7.2			19.7
Peak Hour Factor	0.95	0.95	0.95	0.95	0.95	0.95	0.95	0.95	0.95	0.95	0.95	0.95
Adj. Flow (vph)	4	43	780	3	4	1501	51	1	0	5	41	1
Shared Lane Traffic (%)												
Lane Group Flow (vph)	0	47	783	0	4	1552	0	0	6	0	41	34
Enter Blocked Intersection	No	No	No	No	No	No	No	No	No	No	No	No
Lane Alignment	R NA	Left	Left	Right	Left	Left	Right	Left	Left	Right	Left	Left
Median Width(ft)			24			24			24			24
Link Offset(ft)			0			0			0			0
Crosswalk Width(ft)			16			16			16			16
Two way Left Turn Lane												
Headway Factor	1.00	1.00	1.00	1.00	1.00	1.00	1.00	1.00	1.00	1.00	1.00	1.00
Turning Speed (mph)	9	15		9	15		9	15		9	15	
Number of Detectors	1	1	1		1	1		1	1		1	1
Detector Template												
Leading Detector (ft)	50	50	50		50	50		50	50		50	50
Trailing Detector (ft)	0	0	0		0	0		0	0		0	0
Detector 1 Position(ft)	0	0	0		0	0		0	0		0	0
Detector 1 Size(ft)	50	50	50		50	50		50	50		50	50
Detector 1 Type	CI+Ex	CI+Ex	CI+Ex		CI+Ex	CI+Ex		CI+Ex	CI+Ex		CI+Ex	CI+Ex
Detector 1 Channel												
Detector 1 Extend (s)	0.0	0.0	0.0		0.0	0.0		0.0	0.0		0.0	0.0
Detector 1 Queue (s)	0.0	0.0	0.0		0.0	0.0		0.0	0.0		0.0	0.0
Detector 1 Delay (s)	0.0	0.0	0.0		0.0	0.0		0.0	0.0		0.0	0.0
Turn Type	custom	D,P+P	NA		D,P+P	NA		Split	NA		Split	NA
Permitted Phases		1	6		5	2		3	3		4	4
Permitted Phases	1	2			6							
Detector Phase	1	1	6		5	2		3	3		4	4
Switch Phase												
Minimum Initial (s)	3.0	3.0	15.0		3.0	15.0		5.0	5.0		7.0	7.0
Minimum Split (s)	8.0	8.0	22.0		8.0	24.0		23.0	23.0		23.2	23.2
Total Split (s)	15.0	15.0	109.0		15.0	109.0		18.0	18.0		18.0	18.0

Pepper Square TIA  
Lanes, Volumes, Timings

Phase 1 - 2026 Background + Site - AM  
1405: Prestonwood & Belt Line

Lane Group	SBR
Lane Configurations	↑
Traffic Volume (vph)	64
Future Volume (vph)	64
Ideal Flow (vphpl)	1900
Storage Length (ft)	0
Storage Lanes	1
Taper Length (ft)	
Lane Util. Factor	0.95
Frt	0.850
Fit Protected	
Satd. Flow (prot)	1504
Fit Permitted	
Satd. Flow (perm)	1504
Right Turn on Red	Yes
Satd. Flow (RTOR)	89
Link Speed (mph)	
Link Distance (ft)	
Travel Time (s)	
Peak Hour Factor	0.95
Adj. Flow (vph)	67
Shared Lane Traffic (%)	49%
Lane Group Flow (vph)	34
Enter Blocked Intersection	No
Lane Alignment	Right
Median Width(ft)	
Link Offset(ft)	
Crosswalk Width(ft)	
Two way Left Turn Lane	
Headway Factor	1.00
Turning Speed (mph)	9
Number of Detectors	1
Detector Template	
Leading Detector (ft)	50
Trailing Detector (ft)	0
Detector 1 Position(ft)	0
Detector 1 Size(ft)	50
Detector 1 Type	CI+Ex
Detector 1 Channel	
Detector 1 Extend (s)	0.0
Detector 1 Queue (s)	0.0
Detector 1 Delay (s)	0.0
Turn Type	custom
Protected Phases	
Permitted Phases	1 4
Detector Phase	1 4
Switch Phase	
Minimum Initial (s)	
Minimum Split (s)	
Total Split (s)	

Pepper Square TIA  
Lanes, Volumes, Timings

Phase 1 - 2026 Background + Site - AM  
1405: Prestonwood & Belt Line

Lane Group	EBU	EBL	EBT	EBR	WBL	WBT	WBR	NBL	NBT	NBR	SBL	SBT
Total Split (%)	9.4%	9.4%	68.1%		9.4%	68.1%		11.3%	11.3%		11.3%	11.3%
Maximum Green (s)	10.0	10.0	103.0		10.0	103.0		13.0	13.0		12.8	12.8
Yellow Time (s)	3.0	3.0	4.5		3.0	4.5		3.0	3.0		3.2	3.2
All-Red Time (s)	2.0	2.0	1.5		2.0	1.5		2.0	2.0		2.0	2.0
Lost Time Adjust (s)		-1.0	-2.0		-1.0	-2.0		-1.0			-1.2	-1.2
Total Lost Time (s)		4.0	4.0		4.0	4.0		4.0			4.0	4.0
Lead/Lag	Lag	Lag	Lag		Lead	Lead		Lead	Lead		Lag	Lag
Lead-Lag Optimize?	Yes	Yes	Yes		Yes	Yes		Yes	Yes		Yes	Yes
Vehicle Extension (s)	1.0	1.0	2.5		1.0	2.5		1.5	1.5		1.5	1.5
Recall Mode	None	None	C-Max		None	Max		None	None		None	None
Walk Time (s)			5.0		4.0			4.0	4.0		4.0	4.0
Flash Dont Walk (s)			10.0		14.0			14.0	14.0		14.0	14.0
Pedestrian Calls (#/hr)			0		0			0	0		0	0
Act Effect Green (s)		141.7	143.1		143.3	132.9		6.0			8.4	8.4
Actuated g/C Ratio		0.89	0.89		0.90	0.83		0.04			0.05	0.05
v/c Ratio		0.15	0.17		0.01	0.37		0.03			0.23	0.31
Control Delay		3.8	1.5		0.8	1.8		0.3			75.9	29.8
Queue Delay		0.0	0.0		0.0	0.0		0.0			0.0	0.0
Total Delay		3.8	1.5		0.8	1.8		0.3			75.9	29.8
LOS		A	A		A	A		A			E	C
Approach Delay			1.6			1.8		0.3				38.2
Approach LOS			A			A		A				D
Queue Length 50th (ft)		3	21		0	52		0			21	1
Queue Length 95th (ft)		12	59		m1	75		0			43	41
Internal Link Dist (ft)			1365			1956		235				788
Turn Bay Length (ft)		200			200						300	
Base Capacity (vph)		328	4544		649	4203		262			300	162
Starvation Cap Reductn		0	0		0	0		0			0	0
Spillback Cap Reductn		0	0		0	0		0			0	0
Storage Cap Reductn		0	0		0	0		0			0	0
Reduced v/c Ratio		0.14	0.17		0.01	0.37		0.02			0.14	0.21

**Intersection Summary**  
 Area Type: Other  
 Cycle Length: 160  
 Actuated Cycle Length: 160  
 Offset: 73 (46%), Referenced to phase 6:EBWB, Start of Yellow  
 Natural Cycle: 80  
 Control Type: Actuated-Coordinated  
 Maximum v/c Ratio: 0.37  
 Intersection Signal Delay: 3.3  
 Intersection Capacity Utilization 52.8%  
 Analysis Period (min) 15  
 m Volume for 95th percentile queue is metered by upstream signal.

Splits and Phases: 1405: Prestonwood & Belt Line





Lane Group	SBR
Total Split (%)	
Maximum Green (s)	
Yellow Time (s)	
All-Red Time (s)	
Lost Time Adjust (s)	
Total Lost Time (s)	
Lead/Lag	
Lead-Lag Optimize?	
Vehicle Extension (s)	
Recall Mode	
Walk Time (s)	
Flash Dont Walk (s)	
Pedestrian Calls (#/hr)	
Act Effect Green (s)	20.5
Actuated g/C Ratio	0.13
v/c Ratio	0.13
Control Delay	1.0
Queue Delay	0.0
Total Delay	1.0
LOS	A
Approach Delay	
Approach LOS	
Queue Length 50th (ft)	0
Queue Length 95th (ft)	0
Internal Link Dist (ft)	
Turn Bay Length (ft)	
Base Capacity (vph)	338
Starvation Cap Reductn	0
Spillback Cap Reductn	0
Storage Cap Reductn	0
Reduced v/c Ratio	0.10
Intersection Summary	

Pepper Square TIA  
HCM 6th TWSC

Phase 1 - 2026 Background + Site - AM  
2: Ladera Drive & Belt Line

Intersection												
Int Delay, s/veh	3.7											
Movement	EBL	EBT	EBR	WBL	WBT	WBR	NBL	NBT	NBR	SBL	SBT	SBR
Lane Configurations	↔ ↗ ↘			↔ ↗ ↘				↕	↕		↕	↕
Traffic Vol, veh/h	44	728	15	23	1325	16	41	0	65	28	0	94
Future Vol, veh/h	44	728	15	23	1325	16	41	0	65	28	0	94
Conflicting Peds, #/hr	0	0	0	0	0	0	0	0	0	0	0	0
Sign Control	Free	Free	Free	Free	Free	Free	Stop	Stop	Stop	Stop	Stop	Stop
RT Channelized	-	-	None	-	-	None	-	-	None	-	-	None
Storage Length	100	-	-	100	-	-	-	-	0	-	-	0
Veh in Median Storage, #	-	0	-	-	0	-	-	1	-	-	1	-
Grade, %	-	0	-	-	0	-	-	0	-	-	0	-
Peak Hour Factor	91	91	91	91	91	91	91	91	91	91	91	91
Heavy Vehicles, %	2	2	2	2	2	2	2	2	2	2	2	2
Mvmt Flow	48	800	16	25	1456	18	45	0	71	31	0	103

Major/Minor	Major1	Major2	Minor1	Minor2
Conflicting Flow All	1474	0	0	816
Stage 1	-	-	-	-
Stage 2	-	-	-	-
Critical Hdwy	5.34	-	-	5.34
Critical Hdwy Stg 1	-	-	-	-
Critical Hdwy Stg 2	-	-	-	-
Follow-up Hdwy	3.12	-	-	3.12
Pot Cap-1 Maneuver	230	-	-	940
Stage 1	-	-	-	-
Stage 2	-	-	-	-
Platoon blocked, %	-	-	1	-
Mov Cap-1 Maneuver	230	-	-	940
Mov Cap-2 Maneuver	-	-	-	-
Stage 1	-	-	-	-
Stage 2	-	-	-	-

Approach	EB	WB	NB	SB
HCM Control Delay, s	1.4	0.2	18.5	43.9
HCM LOS			C	E

Minor Lane/Major Mvmt	NBLn1	NBLn2	EBL	EBT	EBR	WBL	WBT	WBR	SBLn1	SBLn2
Capacity (veh/h)	180	752	230	-	-	940	-	-	60	310
HCM Lane V/C Ratio	0.25	0.095	0.21	-	-	0.027	-	-	0.513	0.333
HCM Control Delay (s)	31.6	10.3	24.8	-	-	8.9	-	-	116.2	22.3
HCM Lane LOS	D	B	C	-	-	A	-	-	F	C
HCM 95th %tile Q(veh)	0.9	0.3	0.8	-	-	0.1	-	-	2	1.4

Notes  
~: Volume exceeds capacity \$: Delay exceeds 300s +: Computation Not Defined \*: All major volume in platoon

Pepper Square TIA  
HCM 6th TWSC

Phase 1 - 2026 Background + Site - AM  
3: Median Opening East of Preston Rd & Belt Line

Intersection													
Int Delay, s/veh	0.3												
Movement	EBU	EBL	EBT	EBR	WBL	WBT	WBR	NBL	NBT	NBR	SBL	SBT	SBR
Lane Configurations	↔ ↗ ↘			↔ ↗ ↘					↕	↕		↕	↕
Traffic Vol, veh/h	4	21	526	4	13	1085	17	1	2	0	1	0	3
Future Vol, veh/h	4	21	526	4	13	1085	17	1	2	0	1	0	3
Conflicting Peds, #/hr	0	0	0	0	0	0	0	0	0	0	0	0	0
Sign Control	Free	Free	Free	Free	Free	Free	Stop	Stop	Stop	Stop	Stop	Stop	
RT Channelized	-	-	-	None	-	-	None	-	-	None	-	-	None
Storage Length	-	150	-	-	200	-	-	-	-	-	-	-	
Veh in Median Storage, #	-	-	0	-	0	-	-	1	-	-	1	-	
Grade, %	-	-	0	-	0	-	-	0	-	-	0	-	
Peak Hour Factor	96	96	96	96	96	96	96	96	96	96	96	96	
Heavy Vehicles, %	2	2	2	2	2	2	2	2	2	2	2	2	
Mvmt Flow	4	22	548	4	14	1130	18	1	2	0	1	0	3

Major/Minor	Major1	Major2	Minor1	Minor2
Conflicting Flow All	838	1148	0	0
Stage 1	-	-	-	-
Stage 2	-	-	-	-
Critical Hdwy	5.64	5.34	-	-
Critical Hdwy Stg 1	-	-	-	-
Critical Hdwy Stg 2	-	-	-	-
Follow-up Hdwy	2.32	3.12	-	-
Pot Cap-1 Maneuver	*1134	*843	-	-
Stage 1	-	-	-	-
Stage 2	-	-	-	-
Platoon blocked, %	1	1	-	-
Mov Cap-1 Maneuver	*879	*879	-	-
Mov Cap-2 Maneuver	-	-	-	-
Stage 1	-	-	-	-
Stage 2	-	-	-	-

Approach	EB	WB	NB	SB
HCM Control Delay, s	0.4	0.1	14.1	10.9
HCM LOS			B	B

Minor Lane/Major Mvmt	NBLn1	EBL	EBT	EBR	WBL	WBT	WBR	SBLn1
Capacity (veh/h)	399	* 879	-	-	640	-	-	615
HCM Lane V/C Ratio	0.008	0.03	-	-	0.021	-	-	0.007
HCM Control Delay (s)	14.1	9.2	-	-	10.7	-	-	10.9
HCM Lane LOS	B	A	-	-	B	-	-	B
HCM 95th %tile Q(veh)	0	0.1	-	-	0.1	-	-	0

Notes  
~: Volume exceeds capacity \$: Delay exceeds 300s +: Computation Not Defined \*: All major volume in platoon

Pepper Square TIA  
HCM 6th TWSC

Phase 1 - 2026 Background + Site - AM  
5: Belt Line & Median between Berry Trail and Alexis Dr

Intersection												
Int Delay, s/veh	0.3											
Movement	EBL	EBT	EBR	WBL	WBT	WBR	NBL	NBT	NBR	SBL	SBT	SBR
Lane Configurations	↔ ↕ ↔			↔ ↕ ↔			↔			↔		
Traffic Vol, veh/h	5	568	6	17	1042	11	8	0	13	6	1	7
Future Vol, veh/h	5	568	6	17	1042	11	8	0	13	6	1	7
Conflicting Peds, #/hr	0	0	0	0	0	0	0	0	0	0	0	0
Sign Control	Free	Free	Free	Free	Free	Stop	Stop	Stop	Stop	Stop	Stop	Stop
RT Channelized	-	-	None	-	-	None	-	-	None	-	-	None
Storage Length	150	-	-	150	-	-	-	-	-	-	-	-
Veh in Median Storage, #	-	0	-	-	0	-	-	1	-	-	1	-
Grade, %	-	0	-	-	0	-	-	0	-	-	0	-
Peak Hour Factor	88	88	88	88	88	88	88	88	88	88	88	88
Heavy Vehicles, %	2	2	2	2	2	2	2	2	2	2	2	2
Mvmt Flow	6	645	7	19	1184	13	9	0	15	7	1	8

Major/Minor	Major1	Major2	Minor1	Minor2
Conflicting Flow All	1197	0	0	652
Stage 1	-	-	-	-
Stage 2	-	-	-	-
Critical Hdwy	5.34	-	-	5.34
Critical Hdwy Stg 1	-	-	-	-
Critical Hdwy Stg 2	-	-	-	-
Follow-up Hdwy	3.12	-	-	3.12
Pot Cap-1 Maneuver	786	-	-	915
Stage 1	-	-	-	-
Stage 2	-	-	-	-
Platoon blocked, %	1	-	-	1
Mov Cap-1 Maneuver	786	-	-	915
Mov Cap-2 Maneuver	-	-	-	-
Stage 1	-	-	-	-
Stage 2	-	-	-	-

Approach	EB	WB	NB	SB
HCM Control Delay, s	0.1	0.1	10.4	11.3
HCM LOS			B	B

Minor Lane/Major Mvmt	NBLn1	EBL	EBT	EBR	WBL	WBT	WBR	SBLn1
Capacity (veh/h)	696	786	-	-	915	-	-	584
HCM Lane V/C Ratio	0.034	0.007	-	-	0.021	-	-	0.027
HCM Control Delay (s)	10.4	9.6	-	-	9	-	-	11.3
HCM Lane LOS	B	A	-	-	A	-	-	B
HCM 95th %tile Q(veh)	0.1	0	-	-	0.1	-	-	0.1

Notes  
 ~: Volume exceeds capacity    \$: Delay exceeds 300s    +: Computation Not Defined    \*: All major volume in platoon

Pepper Square TIA  
HCM 6th TWSC

Phase 1 - 2026 Background + Site - AM  
6: Alexis Drive & Belt Line

Intersection						
Int Delay, s/veh	1.7					
Movement	EBT	EBR	WBL	WBT	NBL	NBR
Lane Configurations	↔ ↕		↔ ↕ ↔		↔ ↕	
Traffic Vol, veh/h	583	4	154	1048	8	144
Future Vol, veh/h	583	4	154	1048	8	144
Conflicting Peds, #/hr	0	0	0	0	0	0
Sign Control	Free	Free	Free	Free	Stop	Stop
RT Channelized	-	None	-	None	-	Yield
Storage Length	-	-	150	-	0	0
Veh in Median Storage, #	0	-	-	0	1	-
Grade, %	0	-	-	0	0	-
Peak Hour Factor	86	86	86	86	86	86
Heavy Vehicles, %	2	2	2	2	2	2
Mvmt Flow	678	5	179	1219	9	167

Major/Minor	Major1	Major2	Minor1
Conflicting Flow All	0	0	683
Stage 1	-	-	-
Stage 2	-	-	-
Critical Hdwy	-	-	5.34
Critical Hdwy Stg 1	-	-	-
Critical Hdwy Stg 2	-	-	-
Follow-up Hdwy	-	-	3.12
Pot Cap-1 Maneuver	-	-	881
Stage 1	-	-	-
Stage 2	-	-	-
Platoon blocked, %	-	-	1
Mov Cap-1 Maneuver	-	-	881
Mov Cap-2 Maneuver	-	-	-
Stage 1	-	-	-
Stage 2	-	-	-

Approach	EB	WB	NB
HCM Control Delay, s	0	1.3	10.8
HCM LOS			B

Minor Lane/Major Mvmt	NBLn1	NBLn2	EBT	EBR	WBL	WBT
Capacity (veh/h)	487	800	-	-	881	-
HCM Lane V/C Ratio	0.019	0.209	-	-	0.203	-
HCM Control Delay (s)	12.5	10.7	-	-	10.1	-
HCM Lane LOS	B	B	-	-	B	-
HCM 95th %tile Q(veh)	0.1	0.8	-	-	0.8	-

Notes  
 ~: Volume exceeds capacity    \$: Delay exceeds 300s    +: Computation Not Defined    \*: All major volume in platoon

Pepper Square TIA  
HCM 6th TWSC

Phase 1 - 2026 Background + Site - AM  
10: Preston & Pepper Square Driveway

Intersection														
Int Delay, s/veh	1.2													
Movement	EBL	EBT	EBR	WBL	WBT	WBR	NBU	NBL	NBT	NBR	SBU	SBL	SBT	SBR
Lane Configurations		↔			↔	↔			↔	↔			↔	↔
Traffic Vol, veh/h	10	3	26	7	1	15	1	51	1827	21	1	15	1995	68
Future Vol, veh/h	10	3	26	7	1	15	1	51	1827	21	1	15	1995	68
Conflicting Peds, #/hr	0	0	0	0	0	0	0	0	0	0	0	0	0	0
Sign Control	Stop	Stop	Stop	Stop	Stop	Free	Free	Free	Free	Free	Free	Free	Free	Free
RT Channelized	-	-	None	-	-	None	-	-	None	-	-	-	-	None
Storage Length	-	-	-	-	-	0	-	150	-	-	-	150	-	-
Veh in Median Storage, #	-	1	-	-	1	-	-	-	0	-	-	-	0	-
Grade, %	-	0	-	-	0	-	-	-	0	-	-	-	0	-
Peak Hour Factor	89	89	89	89	89	89	89	89	89	89	89	89	89	89
Heavy Vehicles, %	2	2	2	2	2	2	2	2	2	2	2	2	2	2
Mvmt Flow	11	3	29	8	1	17	1	57	2053	24	1	17	2242	76

Major/Minor	Minor2	Minor1	Major1	Major2
Conflicting Flow All	3254	4509	1159	3115
Stage 1	2316	2316	-	2181
Stage 2	938	2193	-	934
Critical Hdwy	6.44	6.54	7.14	6.44
Critical Hdwy Stg 1	7.34	5.54	-	7.34
Critical Hdwy Stg 2	6.74	5.54	-	6.74
Follow-up Hdwy	3.82	4.02	3.92	3.82
Pot Cap-1 Maneuver	31	~1	*460	*46
Stage 1	377	388	-	*28
Stage 2	257	82	-	*472
Platoon blocked, %	1	1	1	1
Mov Cap-1 Maneuver	23	0	*460	*35
Mov Cap-2 Maneuver	119	42	-	*22
Stage 1	333	329	-	*25
Stage 2	204	72	-	*371

Approach	EB	WB	NB	SB
HCM Control Delay, s	30.6	95.3	0.4	0.3
HCM LOS	D	F		

Minor Lane/Major Mvmt	NBL	NBT	NBR	EBLn1	WBLn1	WBLn2	SBL	SBT	SBR
Capacity (veh/h)	496	-	-	184	24	195	117	-	-
HCM Lane V/C Ratio	0.118	-	-	0.238	0.375	0.086	0.154	-	-
HCM Control Delay (s)	13.2	-	-	30.6	226.6	25.2	41.2	-	-
HCM Lane LOS	B	-	-	D	F	D	E	-	-
HCM 95th %tile Q(veh)	0.4	-	-	0.9	1.1	0.3	0.5	-	-

Notes  
 ~: Volume exceeds capacity    \$: Delay exceeds 300s    +: Computation Not Defined    \*: All major volume in platoon

Pepper Square TIA  
HCM 6th TWSC

Phase 1 - 2026 Background + Site - AM  
20: Preston & Drive 2

Intersection						
Int Delay, s/veh	0					
Movement	WBL	WBR	NBT	NBR	SBL	SBT
Lane Configurations		↔	↔	↔		↔
Traffic Vol, veh/h	0	2	1817	0	0	2084
Future Vol, veh/h	0	2	1817	0	0	2084
Conflicting Peds, #/hr	0	0	0	0	0	0
Sign Control	Stop	Stop	Free	Free	Free	Free
RT Channelized	-	None	-	None	-	None
Storage Length	-	0	-	-	-	-
Veh in Median Storage, #	0	-	0	-	-	0
Grade, %	0	-	0	-	-	0
Peak Hour Factor	92	92	92	92	92	92
Heavy Vehicles, %	2	2	2	2	2	2
Mvmt Flow	0	2	1975	0	0	2265

Major/Minor	Minor1	Major1	Major2
Conflicting Flow All	-	988	0
Stage 1	-	-	-
Stage 2	-	-	-
Critical Hdwy	-	7.14	-
Critical Hdwy Stg 1	-	-	-
Critical Hdwy Stg 2	-	-	-
Follow-up Hdwy	-	3.92	-
Pot Cap-1 Maneuver	0	211	-
Stage 1	0	-	-
Stage 2	0	-	-
Platoon blocked, %	-	-	-
Mov Cap-1 Maneuver	-	211	-
Mov Cap-2 Maneuver	-	-	-
Stage 1	-	-	-
Stage 2	-	-	-

Approach	WB	NB	SB
HCM Control Delay, s	22.2	0	0
HCM LOS	C		

Minor Lane/Major Mvmt	NBT	NBR	WBLn1	SBT
Capacity (veh/h)	-	-	211	-
HCM Lane V/C Ratio	-	-	0.01	-
HCM Control Delay (s)	-	-	22.2	-
HCM Lane LOS	-	-	C	-
HCM 95th %tile Q(veh)	-	-	0	-

Pepper Square TIA  
HCM 6th TWSC

Phase 1 - 2026 Background + Site - AM  
21: Preston & Drive 1

Intersection						
Int Delay, s/veh	0					
Movement	WBL	WBR	NBT	NBR	SBL	SBT
Lane Configurations		↑↑↑	↑↑↑			↑↑↑
Traffic Vol, veh/h	0	0	1900	0	0	2027
Future Vol, veh/h	0	0	1900	0	0	2027
Conflicting Peds, #/hr	0	0	0	0	0	0
Sign Control	Stop	Stop	Free	Free	Free	Free
RT Channelized	-	None	-	None	-	None
Storage Length	-	0	-	-	-	-
Veh in Median Storage, #	0	-	0	-	0	0
Grade, %	0	-	0	-	0	0
Peak Hour Factor	92	92	92	92	92	92
Heavy Vehicles, %	2	2	2	2	2	2
Mvmt Flow	0	0	2065	0	0	2203

Major/Minor	Minor1	Major1	Major2		
Conflicting Flow All	-	1033	0	0	-
Stage 1	-	-	-	-	-
Stage 2	-	-	-	-	-
Critical Hdwy	-	7.14	-	-	-
Critical Hdwy Stg 1	-	-	-	-	-
Critical Hdwy Stg 2	-	-	-	-	-
Follow-up Hdwy	-	3.92	-	-	-
Pot Cap-1 Maneuver	0	197	-	0	-
Stage 1	0	-	-	0	-
Stage 2	0	-	-	0	-
Platoon blocked, %	-	-	-	-	-
Mov Cap-1 Maneuver	-	197	-	-	-
Mov Cap-2 Maneuver	-	-	-	-	-
Stage 1	-	-	-	-	-
Stage 2	-	-	-	-	-

Approach	WB	NB	SB
HCM Control Delay, s	0	0	0
HCM LOS	A		

Minor Lane/Major Mvmt	NBT	NBRWBLn1	SBT
Capacity (veh/h)	-	-	-
HCM Lane V/C Ratio	-	-	-
HCM Control Delay (s)	-	0	-
HCM Lane LOS	-	A	-
HCM 95th %tile Q(veh)	-	-	-

Pepper Square TIA  
HCM 6th TWSC

Phase 1 - 2026 Background + Site - AM  
22: Drive 6 & Belt Line

Intersection						
Int Delay, s/veh	0					
Movement	EBT	EBR	WBL	WBT	NBL	NBR
Lane Configurations	↑↑↑			↑↑↑		↑
Traffic Vol, veh/h	526	0	0	1122	0	0
Future Vol, veh/h	526	0	0	1122	0	0
Conflicting Peds, #/hr	0	0	0	0	0	0
Sign Control	Free	Free	Free	Free	Stop	Stop
RT Channelized	-	None	-	None	-	None
Storage Length	-	-	-	-	-	0
Veh in Median Storage, #	0	-	-	0	0	-
Grade, %	0	-	-	0	0	-
Peak Hour Factor	96	96	96	96	96	96
Heavy Vehicles, %	2	2	2	2	2	2
Mvmt Flow	548	0	0	1169	0	0

Major/Minor	Major1	Major2	Minor1		
Conflicting Flow All	0	0	-	-	274
Stage 1	-	-	-	-	-
Stage 2	-	-	-	-	-
Critical Hdwy	-	-	-	-	7.14
Critical Hdwy Stg 1	-	-	-	-	-
Critical Hdwy Stg 2	-	-	-	-	-
Follow-up Hdwy	-	-	-	-	3.92
Pot Cap-1 Maneuver	-	0	-	0	617
Stage 1	-	0	-	0	-
Stage 2	-	0	-	0	-
Platoon blocked, %	-	-	-	-	-
Mov Cap-1 Maneuver	-	-	-	-	617
Mov Cap-2 Maneuver	-	-	-	-	-
Stage 1	-	-	-	-	-
Stage 2	-	-	-	-	-

Approach	EB	WB	NB
HCM Control Delay, s	0	0	0
HCM LOS			A

Minor Lane/Major Mvmt	NBLn1	EBT	EBR	WBT
Capacity (veh/h)	-	-	-	-
HCM Lane V/C Ratio	-	-	-	-
HCM Control Delay (s)	0	-	-	-
HCM Lane LOS	A	-	-	-
HCM 95th %tile Q(veh)	-	-	-	-

Pepper Square TIA  
HCM 6th TWSC

Phase 1 - 2026 Background + Site - AM  
24: Drive 5 & Belt Line

Intersection						
Int Delay, s/veh	0					
Movement	EBT	EBR	WBL	WBT	NBL	NBR
Lane Configurations	↑↑↑			↑↑↑		↑
Traffic Vol, veh/h	556	0	0	1074	0	0
Future Vol, veh/h	556	0	0	1074	0	0
Conflicting Peds, #/hr	0	0	0	0	0	0
Sign Control	Free	Free	Free	Free	Stop	Stop
RT Channelized	-	None	-	None	-	None
Storage Length	-	-	-	-	-	0
Veh in Median Storage, #	0	-	-	0	0	-
Grade, %	0	-	-	0	0	-
Peak Hour Factor	96	96	96	96	96	96
Heavy Vehicles, %	2	2	2	2	2	2
Mvmt Flow	579	0	0	1119	0	0

Major/Minor	Major1	Major2	Minor1
Conflicting Flow All	0	0	- 290
Stage 1	-	-	-
Stage 2	-	-	-
Critical Hdwy	-	-	- 7.14
Critical Hdwy Stg 1	-	-	-
Critical Hdwy Stg 2	-	-	-
Follow-up Hdwy	-	-	- 3.92
Pot Cap-1 Maneuver	-	0	- 0 603
Stage 1	-	0	- 0
Stage 2	-	0	- 0
Platoon blocked, %	-	-	-
Mov Cap-1 Maneuver	-	-	- 603
Mov Cap-2 Maneuver	-	-	-
Stage 1	-	-	-
Stage 2	-	-	-

Approach	EB	WB	NB
HCM Control Delay, s	0	0	0
HCM LOS			A

Minor Lane/Major Mvmt	NBLn1	EBT	EBR	WBT
Capacity (veh/h)	-	-	-	-
HCM Lane V/C Ratio	-	-	-	-
HCM Control Delay (s)	0	-	-	-
HCM Lane LOS	A	-	-	-
HCM 95th %tile Q(veh)	-	-	-	-

Pepper Square TIA  
HCM 6th TWSC

Phase 1 - 2026 Background + Site - AM  
25: Preston & Drive 4

Intersection						
Int Delay, s/veh	0					
Movement	WBL	WBR	NBT	NBR	SBL	SBT
Lane Configurations		↑	↑↑↑			↑↑↑
Traffic Vol, veh/h	0	5	1853	3	0	2084
Future Vol, veh/h	0	5	1853	3	0	2084
Conflicting Peds, #/hr	0	0	0	0	0	0
Sign Control	Stop	Stop	Free	Free	Free	Free
RT Channelized	-	None	-	None	-	None
Storage Length	-	0	-	-	-	-
Veh in Median Storage, #	0	-	0	-	-	0
Grade, %	0	-	0	-	-	0
Peak Hour Factor	92	92	92	92	92	92
Heavy Vehicles, %	2	2	2	2	2	2
Mvmt Flow	0	5	2014	3	0	2265

Major/Minor	Minor1	Major1	Major2
Conflicting Flow All	- 1009	0	0 - -
Stage 1	-	-	- - -
Stage 2	-	-	- - -
Critical Hdwy	- 7.14	-	- - -
Critical Hdwy Stg 1	-	-	- - -
Critical Hdwy Stg 2	-	-	- - -
Follow-up Hdwy	- 3.92	-	- - -
Pot Cap-1 Maneuver	0 205	-	- 0 -
Stage 1	0	-	- 0 -
Stage 2	0	-	- 0 -
Platoon blocked, %	-	-	- - -
Mov Cap-1 Maneuver	- 205	-	- - -
Mov Cap-2 Maneuver	-	-	- - -
Stage 1	-	-	- - -
Stage 2	-	-	- - -

Approach	WB	NB	SB
HCM Control Delay, s	23	0	0
HCM LOS	C		

Minor Lane/Major Mvmt	NBT	NBRWBLn1	SBT
Capacity (veh/h)	-	- 205	-
HCM Lane V/C Ratio	-	- 0.027	-
HCM Control Delay (s)	-	- 23	-
HCM Lane LOS	-	- C	-
HCM 95th %tile Q(veh)	-	- 0.1	-

Intersection						
Int Delay, s/veh	0					
Movement	WBL	WBR	NBT	NBR	SBL	SBT
Lane Configurations			↑↑↑			↑↑↑
Traffic Vol, veh/h	0	3	1853	0	0	2084
Future Vol, veh/h	0	3	1853	0	0	2084
Conflicting Peds, #/hr	0	0	0	0	0	0
Sign Control	Stop	Stop	Free	Free	Free	Free
RT Channelized	-	None	-	None	-	None
Storage Length	-	0	-	-	-	-
Veh in Median Storage, #	0	-	0	-	-	0
Grade, %	0	-	0	-	-	0
Peak Hour Factor	92	92	92	92	92	92
Heavy Vehicles, %	2	2	2	2	2	2
Mvmt Flow	0	3	2014	0	0	2265
Major/Minor	Minor1	Major1	Major2			
Conflicting Flow All	-	1007	0	0	-	-
Stage 1	-	-	-	-	-	-
Stage 2	-	-	-	-	-	-
Critical Hdwy	-	7.14	-	-	-	-
Critical Hdwy Stg 1	-	-	-	-	-	-
Critical Hdwy Stg 2	-	-	-	-	-	-
Follow-up Hdwy	-	3.92	-	-	-	-
Pot Cap-1 Maneuver	0	205	-	-	0	-
Stage 1	0	-	-	-	0	-
Stage 2	0	-	-	-	0	-
Platoon blocked, %	-	-	-	-	-	-
Mov Cap-1 Maneuver	-	205	-	-	-	-
Mov Cap-2 Maneuver	-	-	-	-	-	-
Stage 1	-	-	-	-	-	-
Stage 2	-	-	-	-	-	-
Approach	WB	NB	SB			
HCM Control Delay, s	22.8	0	0			
HCM LOS	C					
Minor Lane/Major Mvmt	NBT	NBRWBLn1	SBT			
Capacity (veh/h)	-	-	205			
HCM Lane V/C Ratio	-	-	0.016			
HCM Control Delay (s)	-	-	22.8			
HCM Lane LOS	-	-	C			
HCM 95th %tile Q(veh)	-	-	0			

Pepper Square TIA  
Lanes, Volumes, Timings

Phase 1 - 2026 Background + Site - PM  
4: Berry Trail & Belt Line

Lane Group	EBL	EBT	EBR	WBL	WBT	WBR	NBL	NBT	NBR	SBL	SBT	SBR
Lane Configurations												
Traffic Volume (vph)	40	1167	31	33	846	32	40	9	27	27	6	34
Future Volume (vph)	40	1167	31	33	846	32	40	9	27	27	6	34
Ideal Flow (vphpl)	1900	1900	1900	1900	1900	1900	1900	1900	1900	1900	1900	1900
Storage Length (ft)	150		0	150		0	0		0	0		0
Storage Lanes	1		0	1		0	1		0	1		0
Taper Length (ft)	25			25			25			25		
Lane Util. Factor	1.00	0.91	0.91	1.00	0.91	0.91	1.00	1.00	1.00	1.00	1.00	1.00
Frt		0.996			0.995			0.888			0.871	
Flt Protected	0.950			0.950			0.950			0.950		
Satd. Flow (prot)	1770	5065	0	1770	5060	0	1770	1654	0	1770	1622	0
Flt Permitted	0.287			0.194			0.909			0.741		
Satd. Flow (perm)	535	5065	0	361	5060	0	1693	1654	0	1380	1622	0
Right Turn on Red		Yes			Yes			Yes			Yes	
Satd. Flow (RTOR)		4			6			29			36	
Link Speed (mph)	42			42			30			30		
Link Distance (ft)	234			493			277			236		
Travel Time (s)	3.8			8.0			6.3			5.4		
Peak Hour Factor	0.94	0.94	0.94	0.94	0.94	0.94	0.94	0.94	0.94	0.94	0.94	0.94
Adj. Flow (vph)	43	1241	33	35	900	34	43	10	29	29	6	36
Shared Lane Traffic (%)												
Lane Group Flow (vph)	43	1274	0	35	934	0	43	39	0	29	42	0
Enter Blocked Intersection	No	No	No	No	No	No	No	No	No	No	No	No
Lane Alignment	Left	Left	Right	Left	Left	Right	Left	Left	Right	Left	Left	Right
Median Width(ft)	12			12			12			12		
Link Offset(ft)	0			0			0			0		
Crosswalk Width(ft)	16			16			16			16		
Two way Left Turn Lane												
Headway Factor	1.00	1.00	1.00	1.00	1.00	1.00	1.00	1.00	1.00	1.00	1.00	1.00
Turning Speed (mph)	15		9	15		9	15		9	15		9
Number of Detectors	1	2		1	2		1	2		1	2	
Detector Template	Left	Thru		Left	Thru		Left	Thru		Left	Thru	
Leading Detector (ft)	20	100		20	100		20	100		20	100	
Trailing Detector (ft)	0	0		0	0		0	0		0	0	
Detector 1 Position(ft)	0	0		0	0		0	0		0	0	
Detector 1 Size(ft)	20	6		20	6		20	6		20	6	
Detector 1 Type	Cl+Ex	Cl+Ex		Cl+Ex	Cl+Ex		Cl+Ex	Cl+Ex		Cl+Ex	Cl+Ex	
Detector 1 Channel												
Detector 1 Extend (s)	0.0	0.0		0.0	0.0		0.0	0.0		0.0	0.0	
Detector 1 Queue (s)	0.0	0.0		0.0	0.0		0.0	0.0		0.0	0.0	
Detector 1 Delay (s)	0.0	0.0		0.0	0.0		0.0	0.0		0.0	0.0	
Detector 2 Position(ft)		94			94			94			94	
Detector 2 Size(ft)		6			6			6			6	
Detector 2 Type		Cl+Ex			Cl+Ex			Cl+Ex			Cl+Ex	
Detector 2 Channel												
Detector 2 Extend (s)		0.0			0.0			0.0			0.0	
Turn Type	D,P+P	NA		D,P+P	NA		D,P+P	NA		D,P+P	NA	
Protected Phases	3	8		7	4		1	6		5	2	
Permitted Phases	4			8			2			6		

Pepper Square TIA  
Lanes, Volumes, Timings

Phase 1 - 2026 Background + Site - PM  
4: Berry Trail & Belt Line

Lane Group	EBL	EBT	EBR	WBL	WBT	WBR	NBL	NBT	NBR	SBL	SBT	SBR
Detector Phase	3	8		7	4		1	6		5	2	
Switch Phase												
Minimum Initial (s)	4.0	4.0		4.0	4.0		4.0	4.0		4.0	4.0	
Minimum Split (s)	10.0	24.0		10.0	24.0		10.0	31.0		10.0	31.0	
Total Split (s)	15.0	99.0		15.0	99.0		20.0	31.0		15.0	26.0	
Total Split (%)	9.4%	61.9%		9.4%	61.9%		12.5%	19.4%		9.4%	16.3%	
Maximum Green (s)	9.0	93.0		9.0	93.0		14.0	25.0		9.0	20.0	
Yellow Time (s)	4.0	4.0		4.0	4.0		4.0	4.0		4.0	4.0	
All-Red Time (s)	2.0	2.0		2.0	2.0		2.0	2.0		2.0	2.0	
Lost Time Adjust (s)	0.0	0.0		0.0	0.0		0.0	0.0		0.0	0.0	
Total Lost Time (s)	6.0	6.0		6.0	6.0		6.0	6.0		6.0	6.0	
Lead/Lag	Lead	Lag		Lead	Lag		Lead	Lag		Lead	Lag	
Lead-Lag Optimize?	Yes	Yes		Yes	Yes		Yes	Yes		Yes	Yes	
Vehicle Extension (s)	1.0	1.0		1.0	1.0		1.0	1.0		1.0	1.0	
Recall Mode	None	C-Max		None	C-Max		None	None		None	None	
Walk Time (s)		4.0			4.0			4.0			4.0	
Flash Dont Walk (s)		14.0			14.0			21.0			21.0	
Pedestrian Calls (#/hr)		0			0			0			0	
Act Effct Green (s)	129.0	126.7		129.0	126.6		11.4	6.2		11.4	5.2	
Actuated g/C Ratio	0.81	0.79		0.81	0.79		0.07	0.04		0.07	0.03	
v/c Ratio	0.09	0.32		0.11	0.23		0.35	0.42		0.26	0.48	
Control Delay	2.2	2.4		1.6	1.7		70.8	45.5		67.8	44.2	
Queue Delay	0.0	0.0		0.0	0.0		0.0	0.0		0.0	0.0	
Total Delay	2.2	2.4		1.6	1.7		70.8	45.5		67.8	44.2	
LOS	A	A		A	A		E	D		E	D	
Approach Delay		2.4			1.7			58.8			53.8	
Approach LOS		A			A			E			D	
Queue Length 50th (ft)	3	43		1	26		42	10		28	6	
Queue Length 95th (ft)	m5	m55		3	61		80	52		60	50	
Internal Link Dist (ft)		154			413			197			156	
Turn Bay Length (ft)	150			150								
Base Capacity (vph)	513	4012		378	4005		193	282		146	234	
Starvation Cap Reductn	0	0		0	0		0	0		0	0	
Spillback Cap Reductn	0	0		0	0		0	0		0	0	
Storage Cap Reductn	0	0		0	0		0	0		0	0	
Reduced v/c Ratio	0.08	0.32		0.09	0.23		0.22	0.14		0.20	0.18	
Intersection Summary												
Area Type:	Other											
Cycle Length:	160											
Actuated Cycle Length:	160											
Offset:	153 (96%), Referenced to phase 4:EBWB and 8:EBWB, Start of Yellow											
Natural Cycle:	75											
Control Type:	Actuated-Coordinated											
Maximum v/c Ratio:	0.48											
Intersection Signal Delay:	5.5						Intersection LOS: A					
Intersection Capacity Utilization:	50.5%						ICU Level of Service A					
Analysis Period (min):	15											
m	Volume for 95th percentile queue is metered by upstream signal.											



Pepper Square TIA  
Lanes, Volumes, Timings

Phase 1 - 2026 Background + Site - PM  
4: Berry Trail & Belt Line

Splits and Phases: 4: Berry Trail & Belt Line

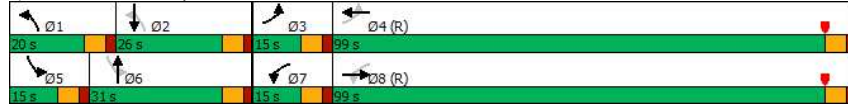

Pepper Square TIA  
Lanes, Volumes, Timings

Phase 1 - 2026 Background + Site - PM  
1335: Meadow Creek & Belt Line

Lane Group	EBL	EBT	EBR	WBL	WBT	WBR	NBL	NBT	NBR	SBL	SBT	SBR
Lane Configurations												
Traffic Volume (vph)	88	1365	44	7	1030	18	18	11	9	12	5	60
Future Volume (vph)	88	1365	44	7	1030	18	18	11	9	12	5	60
Ideal Flow (vphpl)	1900	1900	1900	1900	1900	1900	1900	1900	1900	1900	1900	1900
Storage Length (ft)	150		0	150		0	0		0	0		0
Storage Lanes	1		0	1		0	0		0	0		0
Taper Length (ft)	25			25			25			25		
Lane Util. Factor	1.00	0.91	0.91	1.00	0.91	0.91	1.00	1.00	1.00	1.00	1.00	1.00
Frt		0.995			0.997			0.970				0.895
Flt Protected	0.950			0.950				0.977				0.992
Satd. Flow (prot)	1770	5060	0	1770	5070	0	0	1765	0	0	1654	0
Flt Permitted	0.245			0.161				0.528				0.945
Satd. Flow (perm)	456	5060	0	300	5070	0	0	954	0	0	1575	0
Right Turn on Red			Yes			Yes			Yes			Yes
Satd. Flow (RTOR)		6			3			9				63
Link Speed (mph)	42			42			30					30
Link Distance (ft)		1673			2404		392					423
Travel Time (s)		27.2			39.0		8.9					9.6
Peak Hour Factor	0.95	0.95	0.95	0.95	0.95	0.95	0.95	0.95	0.95	0.95	0.95	0.95
Adj. Flow (vph)	93	1437	46	7	1084	19	19	12	9	13	5	63
Shared Lane Traffic (%)												
Lane Group Flow (vph)	93	1483	0	7	1103	0	0	40	0	0	81	0
Enter Blocked Intersection	No	No	No	No	No	No	No	No	No	No	No	No
Lane Alignment	Left	Left	Right	Left	Left	Right	Left	Left	Right	Left	Left	Right
Median Width(ft)	12			12			0					0
Link Offset(ft)	0			0			0					0
Crosswalk Width(ft)	16			16			16					16
Two way Left Turn Lane												
Headway Factor	1.00	1.00	1.00	1.00	1.00	1.00	1.00	1.00	1.00	1.00	1.00	1.00
Turning Speed (mph)	15		9	15		9	15		9	15		9
Number of Detectors	1	1		1	1		1	1		1		1
Detector Template												
Leading Detector (ft)	50	50		50	50		50	50		50		50
Trailing Detector (ft)	0	0		0	0		0	0		0		0
Detector 1 Position(ft)	0	0		0	0		0	0		0		0
Detector 1 Size(ft)	50	50		50	50		50	50		50		50
Detector 1 Type	CI+Ex	CI+Ex		CI+Ex	CI+Ex		CI+Ex	CI+Ex		CI+Ex		CI+Ex
Detector 1 Channel												
Detector 1 Extend (s)	0.0	0.0		0.0	0.0		0.0	0.0		0.0		0.0
Detector 1 Queue (s)	0.0	0.0		0.0	0.0		0.0	0.0		0.0		0.0
Detector 1 Delay (s)	0.0	0.0		0.0	0.0		0.0	0.0		0.0		0.0
Turn Type	Perm	NA		Perm	NA		Perm	NA		Perm		NA
Protected Phases		6			2			4				4
Permitted Phases	6			2			4			4		
Detector Phase	6	6		2	2		4	4		4		4
Switch Phase												
Minimum Initial (s)	12.0	12.0		12.0	12.0		6.0	6.0		6.0		6.0
Minimum Split (s)	17.0	17.0		17.0	17.0		23.5	23.5		23.5		23.5
Total Split (s)	110.0	110.0		110.0	110.0		50.0	50.0		50.0		50.0

Pepper Square TIA  
Lanes, Volumes, Timings

Phase 1 - 2026 Background + Site - PM  
1335: Meadow Creek & Belt Line



Lane Group	EBL	EBT	EBR	WBL	WBT	WBR	NBL	NBT	NBR	SBL	SBT	SBR
Total Split (%)	68.8%	68.8%		68.8%	68.8%		31.3%	31.3%		31.3%	31.3%	
Maximum Green (s)	105.0	105.0		105.0	105.0		44.5	44.5		44.5	44.5	
Yellow Time (s)	4.0	4.0		4.0	4.0		3.7	3.7		3.7	3.7	
All-Red Time (s)	1.0	1.0		1.0	1.0		1.8	1.8		1.8	1.8	
Lost Time Adjust (s)	-1.0	-1.0		-1.0	-1.0		-1.5	-1.5		-1.5	-1.5	
Total Lost Time (s)	4.0	4.0		4.0	4.0		4.0	4.0		4.0	4.0	
Lead/Lag												
Lead-Lag Optimize?												
Vehicle Extension (s)	2.0	2.0		2.0	2.0		1.8	1.8		1.8	1.8	
Recall Mode	Min	Min		C-Max	C-Max		None	None		None	None	
Walk Time (s)	4.0	4.0		4.0	4.0		4.0	4.0		4.0	4.0	
Flash Dont Walk (s)	8.0	8.0		8.0	8.0		14.0	14.0		14.0	14.0	
Pedestrian Calls (#/hr)	0	0		0	0		0	0		0	0	
Act Effect Green (s)	142.5	142.5		142.5	142.5		9.5	9.5		9.5	9.5	
Actuated g/C Ratio	0.89	0.89		0.89	0.89		0.06	0.06		0.06	0.06	
v/c Ratio	0.23	0.33		0.03	0.24		0.62	0.62		0.53	0.53	
Control Delay	2.2	1.1		0.1	0.1		95.8	95.8		35.6	35.6	
Queue Delay	0.0	0.0		0.0	0.0		0.0	0.0		0.0	0.0	
Total Delay	2.2	1.1		0.1	0.1		95.8	95.8		35.6	35.6	
LOS	A	A		A	A		F	F		D	D	
Approach Delay		1.1			0.1		95.8	95.8		35.6	35.6	
Approach LOS		A			A		F	F		D	D	
Queue Length 50th (ft)	9	57		0	4		32	32		18	18	
Queue Length 95th (ft)	18	70		m0	m5		75	75		75	75	
Internal Link Dist (ft)		1593			2324		312	312		343	343	
Turn Bay Length (ft)	150			150								
Base Capacity (vph)	405	4506		267	4514		280	280		497	497	
Starvation Cap Reductn	0	0		0	0		0	0		0	0	
Spillback Cap Reductn	0	0		0	0		0	0		0	0	
Storage Cap Reductn	0	0		0	0		0	0		0	0	
Reduced v/c Ratio	0.23	0.33		0.03	0.24		0.14	0.14		0.16	0.16	

Intersection Summary

Area Type: Other  
 Cycle Length: 160  
 Actuated Cycle Length: 160  
 Offset: 73 (46%), Referenced to phase 2:WBTL, Start of Yellow  
 Natural Cycle: 60  
 Control Type: Actuated-Coordinated  
 Maximum v/c Ratio: 0.62  
 Intersection Signal Delay: 3.1 Intersection LOS: A  
 Intersection Capacity Utilization 52.5% ICU Level of Service A  
 Analysis Period (min) 15  
 m Volume for 95th percentile queue is metered by upstream signal.

Splits and Phases: 1335: Meadow Creek & Belt Line



Kimley-Horn

Page 5

Pepper Square TIA  
Lanes, Volumes, Timings

Phase 1 - 2026 Background + Site - PM  
1365: Preston & Arapahoe

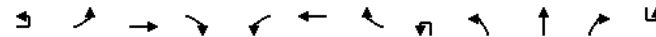

Lane Group	EBU	EBL	EBT	EBR	WBL	WBT	WBR	NBU	NBL	NBT	NBR	SBU
Lane Configurations		T	T		T	T			T	T		
Traffic Volume (vph)	1	272	940	187	168	581	150	3	196	1777	209	5
Future Volume (vph)	1	272	940	187	168	581	150	3	196	1777	209	5
Ideal Flow (vphpl)	1900	1900	1900	1900	1900	1900	1900	1900	1900	1900	1900	1900
Storage Length (ft)		150		0	150		0		300		0	
Storage Lanes		2		0	2		0		2		0	
Taper Length (ft)		25			25				25			
Lane Util. Factor	0.91	0.97	0.91	0.91	0.97	0.91	0.91	0.91	0.97	0.91	0.91	0.91
Frt			0.975			0.969				0.984		
Fit Protected		0.950			0.950				0.950			
Satd. Flow (prot)	0	3433	4958	0	3433	4928	0	0	3433	5004	0	0
Fit Permitted		0.950			0.950				0.950			
Satd. Flow (perm)	0	3433	4958	0	3433	4928	0	0	3433	5004	0	0
Right Turn on Red				Yes			Yes				Yes	
Satd. Flow (RTOR)			27			36					17	
Link Speed (mph)			42			42					42	
Link Distance (ft)			1672			1942					3054	
Travel Time (s)			27.1			31.5					49.6	
Peak Hour Factor	0.93	0.93	0.93	0.93	0.93	0.93	0.93	0.93	0.93	0.93	0.93	0.93
Adj. Flow (vph)	1	292	1011	201	181	625	161	3	211	1911	225	5
Shared Lane Traffic (%)												
Lane Group Flow (vph)	0	293	1212	0	181	786	0	0	214	2136	0	0
Enter Blocked Intersection	No	No	No	No	No	No	No	No	No	No	No	No
Lane Alignment	R NA	Left	Left	Right	Left	Left	Right	R NA	Left	Left	Right	R NA
Median Width(ft)			24			24					24	
Link Offset(ft)			0			0					0	
Crosswalk Width(ft)				16		16					16	
Two way Left Turn Lane												
Headway Factor	1.00	1.00	1.00	1.00	1.00	1.00	1.00	1.00	1.00	1.00	1.00	1.00
Turning Speed (mph)	9	15			9	15			9	15		9
Number of Detectors	1	1	1		1	1			1	1	1	1
Detector Template												
Leading Detector (ft)	50	50	50		50	50			50	50	50	50
Trailing Detector (ft)	0	0	0		0	0			0	0	0	0
Detector 1 Position(ft)	0	0	0		0	0			0	0	0	0
Detector 1 Size(ft)	50	50	50		50	50			50	50	50	50
Detector 1 Type	CI+Ex	CI+Ex	CI+Ex		CI+Ex	CI+Ex			CI+Ex	CI+Ex	CI+Ex	CI+Ex
Detector 1 Channel												
Detector 1 Extend (s)	0.0	0.0	0.0		0.0	0.0			0.0	0.0	0.0	0.0
Detector 1 Queue (s)	0.0	0.0	0.0		0.0	0.0			0.0	0.0	0.0	0.0
Detector 1 Delay (s)	0.0	0.0	0.0		0.0	0.0			0.0	0.0	0.0	0.0
Turn Type	Prot	Prot	NA		Prot	NA			Prot	Prot	NA	Prot
Protected Phases	3	3	8		7	4			1	1	6	5
Permitted Phases												
Detector Phase	3	3	8		7	4			1	1	6	5
Switch Phase												
Minimum Initial (s)	3.0	3.0	18.0		3.0	18.0			3.0	3.0	18.0	3.0
Minimum Split (s)	10.0	10.0	36.7		21.0	36.3			10.0	10.0	35.7	10.0
Total Split (s)	30.0	30.0	53.0		13.0	36.0			24.0	24.0	76.0	18.0

09/22/2022 11:11 am  
Kimley-Horn

Synchro 11 Report  
Page 6

Pepper Square TIA  
Lanes, Volumes, Timings

Phase 1 - 2026 Background + Site - PM  
1365: Preston & Arapaho

Lane Group	SBL	SBT	SBR
Lane Configurations			
Traffic Volume (vph)	213	1379	183
Future Volume (vph)	213	1379	183
Ideal Flow (vphpl)	1900	1900	1900
Storage Length (ft)	250		0
Storage Lanes	2		0
Taper Length (ft)	25		
Lane Util. Factor	0.97	0.91	0.91
Frt		0.982	
Fit Protected	0.950		
Satd. Flow (prot)	3433	4994	0
Fit Permitted	0.950		
Satd. Flow (perm)	3433	4994	0
Right Turn on Red			Yes
Satd. Flow (RTOR)		18	
Link Speed (mph)		48	
Link Distance (ft)		5087	
Travel Time (s)		72.3	
Peak Hour Factor	0.93	0.93	0.93
Adj. Flow (vph)	229	1483	197
Shared Lane Traffic (%)			
Lane Group Flow (vph)	234	1680	0
Enter Blocked Intersection	No	No	No
Lane Alignment	Left	Left	Right
Median Width(ft)		24	
Link Offset(ft)		0	
Crosswalk Width(ft)		16	
Two way Left Turn Lane			
Headway Factor	1.00	1.00	1.00
Turning Speed (mph)	15		9
Number of Detectors	1	1	
Detector Template			
Leading Detector (ft)	50	50	
Trailing Detector (ft)	0	0	
Detector 1 Position(ft)	0	0	
Detector 1 Size(ft)	50	50	
Detector 1 Type	CI+Ex	CI+Ex	
Detector 1 Channel			
Detector 1 Extend (s)	0.0	0.0	
Detector 1 Queue (s)	0.0	0.0	
Detector 1 Delay (s)	0.0	0.0	
Turn Type	Prot	NA	
Protected Phases	5	2	
Permitted Phases			
Detector Phase	5	2	
Switch Phase			
Minimum Initial (s)	3.0	18.0	
Minimum Split (s)	10.0	37.7	
Total Split (s)	18.0	70.0	

Pepper Square TIA  
Lanes, Volumes, Timings

Phase 1 - 2026 Background + Site - PM  
1365: Preston & Arapaho

Lane Group	EBU	EBL	EBT	EBR	WBL	WBT	WBR	NBU	NBL	NBT	NBR	SBU
Total Split (%)	18.8%	18.8%	33.1%		8.1%	22.5%		15.0%	15.0%	47.5%		11.3%
Maximum Green (s)	24.5	24.5	47.7		7.5	30.7		18.5	18.5	70.3		12.5
Yellow Time (s)	3.0	3.0	4.3		3.0	4.3		3.0	3.0	4.7		3.0
All-Red Time (s)	2.5	2.5	1.0		2.5	1.0		2.5	2.5	1.0		2.5
Lost Time Adjust (s)		-1.0	-1.4		-1.0	-1.0			-1.0	-1.7		
Total Lost Time (s)		4.5	3.9		4.5	4.3		4.5	4.0			
Lead/Lag	Lead	Lead	Lead		Lag	Lag		Lead	Lead	Lead		Lag
Lead-Lag Optimize?	Yes	Yes	Yes		Yes	Yes		Yes	Yes	Yes		Yes
Vehicle Extension (s)	0.8	0.8	2.5		0.8	1.8		1.5	1.5	1.7		1.5
Recall Mode	None	None	Max		None	None		None	None	Max		None
Walk Time (s)			4.0			4.0				4.0		
Flash Dont Walk (s)			27.0			27.0				26.0		
Pedestrian Calls (#/hr)			0			0				0		
Act Effect Green (s)		17.9	49.1		8.5	39.3			14.8	72.0		
Actuated g/C Ratio		0.11	0.31		0.05	0.25			0.09	0.45		
v/c Ratio		0.76	0.79		0.99	0.64			0.67	0.94		
Control Delay		81.2	53.1		130.5	49.6			97.4	26.5		
Queue Delay		0.0	0.0		0.0	0.0			0.0	0.0		
Total Delay		81.2	53.1		130.5	49.6			97.4	26.5		
LOS		F	D		F	D			F	C		
Approach Delay			58.6			64.8				33.0		
Approach LOS			E			E				C		
Queue Length 50th (ft)			156		100	237			103	187		
Queue Length 95th (ft)			203		#186	269			m119	m206		
Internal Link Dist (ft)			1592			1862				2974		
Turn Bay Length (ft)		150			150				300			
Base Capacity (vph)		547	1540		182	1237			418	2261		
Starvation Cap Reductn		0	0		0	0			0	0		
Spillback Cap Reductn		0	0		0	0			0	0		
Storage Cap Reductn		0	0		0	0			0	0		
Reduced v/c Ratio		0.54	0.79		0.99	0.64			0.51	0.94		

Intersection Summary	
Area Type:	Other
Cycle Length:	160
Actuated Cycle Length:	160
Offset:	120 (75%), Referenced to phase 2:SBT, Start of Yellow
Natural Cycle:	130
Control Type:	Actuated-Coordinated
Maximum v/c Ratio:	0.99
Intersection Signal Delay:	45.3
Intersection LOS:	D
Intersection Capacity Utilization:	86.5%
ICU Level of Service:	E
Analysis Period (min):	15
#	95th percentile volume exceeds capacity, queue may be longer.
	Queue shown is maximum after two cycles.
m	Volume for 95th percentile queue is metered by upstream signal.

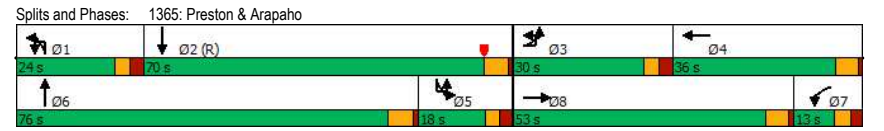

Pepper Square TIA  
Lanes, Volumes, Timings

Phase 1 - 2026 Background + Site - PM  
1365: Preston & Arapaho

Lane Group	SBL	SBT	SBR
Total Split (%)	11.3%	43.8%	
Maximum Green (s)	12.5	64.3	
Yellow Time (s)	3.0	4.7	
All-Red Time (s)	2.5	1.0	
Lost Time Adjust (s)	-1.0	-1.7	
Total Lost Time (s)	4.5	4.0	
Lead/Lag	Lag	Lag	
Lead-Lag Optimize?	Yes	Yes	
Vehicle Extension (s)	1.5	1.5	
Recall Mode	None	C-Max	
Walk Time (s)		4.0	
Flash Dont Walk (s)		28.0	
Pedestrian Calls (#/hr)		0	
Act Effect Green (s)	13.5	70.7	
Actuated g/C Ratio	0.08	0.44	
v/c Ratio	0.81	0.76	
Control Delay	79.5	34.6	
Queue Delay	0.0	0.0	
Total Delay	79.5	34.6	
LOS	E	C	
Approach Delay		40.1	
Approach LOS		D	
Queue Length 50th (ft)	126	541	
Queue Length 95th (ft)	m152	598	
Internal Link Dist (ft)		5007	
Turn Bay Length (ft)	250		
Base Capacity (vph)	289	2215	
Starvation Cap Reductn	0	0	
Spillback Cap Reductn	0	0	
Storage Cap Reductn	0	0	
Reduced v/c Ratio	0.81	0.76	

Intersection Summary

Pepper Square TIA  
Lanes, Volumes, Timings

Phase 1 - 2026 Background + Site - PM  
1367: Preston & Belt Line

Lane Group	EBU	EBL	EBT	EBR	WBU	WBL	WBT	WBR	NBL	NBT	NBR	SBU
Lane Configurations		↔	↔	↔		↔	↔	↔	↔	↔	↔	
Traffic Volume (vph)	45	351	1007	368	1	101	654	119	474	1852	62	2
Future Volume (vph)	45	351	1007	368	1	101	654	119	474	1852	62	2
Ideal Flow (vphpl)	1900	1900	1900	1900	1900	1900	1900	1900	1900	1900	1900	1900
Storage Length (ft)		150		150		200		0	250		0	
Storage Lanes		2		1		1		0	2		0	
Taper Length (ft)		25				25			25			
Lane Util. Factor	0.91	0.97	0.91	1.00	0.91	1.00	0.91	0.91	0.97	0.91	0.91	0.91
Fit				0.850			0.977			0.995		
Fit Protected		0.950				0.950			0.950			
Satd. Flow (prot)	0	3433	5085	1583	0	1770	4968	0	3433	5060	0	0
Fit Permitted		0.950				0.950			0.950			
Satd. Flow (perm)	0	3433	5085	1583	0	1770	4968	0	3433	5060	0	0
Right Turn on Red				Yes			Yes			Yes		Yes
Satd. Flow (RTOR)				220			19			4		
Link Speed (mph)			42				42			42		
Link Distance (ft)			925				394			261		
Travel Time (s)			15.0				6.4			4.2		
Peak Hour Factor	0.96	0.96	0.96	0.96	0.96	0.96	0.96	0.96	0.96	0.96	0.96	0.96
Adj. Flow (vph)	47	366	1049	383	1	105	681	124	494	1929	65	2
Shared Lane Traffic (%)												
Lane Group Flow (vph)	0	413	1049	383	0	106	805	0	494	1994	0	0
Enter Blocked Intersection	No	No	No	No	No	No	No	No	No	No	No	No
Lane Alignment	R NA	Left	Left	Right	R NA	Left	Left	Right	Left	Left	Right	R NA
Median Width(ft)			24				24			24		
Link Offset(ft)			0				0			0		
Crosswalk Width(ft)				16				16			16	
Two way Left Turn Lane												
Headway Factor	1.00	1.00	1.00	1.00	1.00	1.00	1.00	1.00	1.00	1.00	1.00	1.00
Turning Speed (mph)	9	15		9	9	15		9	15		9	9
Number of Detectors	1	1	1	1	1	1	1	1	1	1	1	1
Detector Template												
Leading Detector (ft)	50	50	50	50	50	50	50		50	50		50
Trailing Detector (ft)	0	0	0	0	0	0	0		0	0		0
Detector 1 Position(ft)	0	0	0	0	0	0	0		0	0		0
Detector 1 Size(ft)	50	50	50	50	50	50	50		50	50		50
Detector 1 Type	CI+Ex	CI+Ex	CI+Ex	CI+Ex	CI+Ex	CI+Ex	CI+Ex		CI+Ex	CI+Ex		CI+Ex
Detector 1 Channel												
Detector 1 Extend (s)	0.0	0.0	0.0	0.0	0.0	0.0	0.0		0.0	0.0		0.0
Detector 1 Queue (s)	0.0	0.0	0.0	0.0	0.0	0.0	0.0		0.0	0.0		0.0
Detector 1 Delay (s)	0.0	0.0	0.0	0.0	0.0	0.0	0.0		0.0	0.0		0.0
Turn Type	Prot	Prot	NA	Perm	Prot	Prot	NA		Prot	NA		Prot
Permitted Phases	3 13	3 13	8		17	17	4		1 11	6		5
Detector Phase	3 13	3 13	8	8	17	17	4		1 11	6		5
Switch Phase												
Minimum Initial (s)			18.0	18.0	3.0	3.0	18.0			18.0		3.0
Minimum Split (s)			32.5	32.5	8.0	8.0	32.5			33.0		11.0
Total Split (s)			50.0	50.0	14.0	14.0	27.0			77.0		19.0

Pepper Square TIA  
Lanes, Volumes, Timings

Phase 1 - 2026 Background + Site - PM  
1367: Preston & Belt Line

Lane Group	SBL	SBT	SBR	Ø1	Ø3	Ø11	Ø13
Lane Configurations							
Traffic Volume (vph)	145	1384	256				
Future Volume (vph)	145	1384	256				
Ideal Flow (vphpl)	1900	1900	1900				
Storage Length (ft)	200		300				
Storage Lanes	1		1				
Taper Length (ft)	25						
Lane Util. Factor	1.00	0.91	1.00				
Frt			0.850				
Fit Protected	0.950						
Satd. Flow (prot)	1770	5085	1583				
Fit Permitted	0.950						
Satd. Flow (perm)	1770	5085	1583				
Right Turn on Red			Yes				
Satd. Flow (RTOR)			227				
Link Speed (mph)		40					
Link Distance (ft)		3054					
Travel Time (s)		52.1					
Peak Hour Factor	0.96	0.96	0.96				
Adj. Flow (vph)	151	1442	267				
Shared Lane Traffic (%)							
Lane Group Flow (vph)	153	1442	267				
Enter Blocked Intersection	No	No	No				
Lane Alignment	Left	Left	Right				
Median Width(ft)		24					
Link Offset(ft)		0					
Crosswalk Width(ft)		16					
Two way Left Turn Lane							
Headway Factor	1.00	1.00	1.00				
Turning Speed (mph)	15		9				
Number of Detectors	1	1	1				
Detector Template							
Leading Detector (ft)	50	50	50				
Trailing Detector (ft)	0	0	0				
Detector 1 Position(ft)	0	0	0				
Detector 1 Size(ft)	50	50	50				
Detector 1 Type	Cl+Ex	Cl+Ex	Cl+Ex				
Detector 1 Channel							
Detector 1 Extend (s)	0.0	0.0	0.0				
Detector 1 Queue (s)	0.0	0.0	0.0				
Detector 1 Delay (s)	0.0	0.0	0.0				
Turn Type	Prot	NA	Perm				
Protected Phases	5	2		1	3	11	13
Permitted Phases			2				
Detector Phase	5	2	2				
Switch Phase							
Minimum Initial (s)	3.0	18.0	18.0	3.0	3.0	3.0	3.0
Minimum Split (s)	11.0	33.0	33.0	8.0	11.0	8.0	11.0
Total Split (s)	19.0	60.0	60.0	16.0	20.0	20.0	17.0

Pepper Square TIA  
Lanes, Volumes, Timings

Phase 1 - 2026 Background + Site - PM  
1367: Preston & Belt Line

Lane Group	EBU	EBL	EBT	EBR	WBU	WBL	WBT	WBR	NBL	NBT	NBR	SBU
Total Split (%)			31.3%	31.3%	8.8%	8.8%	16.9%			48.1%		11.9%
Maximum Green (s)			44.5	44.5	9.0	9.0	21.5			71.0		14.0
Yellow Time (s)			4.0	4.0	3.0	3.0	4.0			4.4		3.0
All-Red Time (s)			1.5	1.5	2.0	2.0	1.5			1.6		2.0
Lost Time Adjust (s)			-1.5	-1.5		-1.0	-1.5			-1.7		
Total Lost Time (s)			4.0	4.0		4.0	4.0			4.3		
Lead/Lag									Lag	Lag		Lead
Lead-Lag Optimize?									Yes	Yes		Yes
Vehicle Extension (s)			1.3	1.3	3.0	3.0	1.3			2.0		1.5
Recall Mode			Max	Max	None	None	Max			C-Max		None
Walk Time (s)			7.0	7.0			7.0			7.0		
Flash Dont Walk (s)			20.0	20.0			20.0			20.0		
Pedestrian Calls (#/hr)			0	0			0			0		0
Act Effct Green (s)			28.6	46.0	46.0		10.0	23.4		28.0		72.7
Actuated g/C Ratio			0.18	0.29	0.29		0.06	0.15		0.18		0.45
v/c Ratio			0.67	0.72	0.63		0.96	1.08		0.82		0.87
Control Delay			57.0	61.3	34.2		127.8	87.2		50.5		22.7
Queue Delay			0.0	0.0	0.0		0.0	0.0		0.0		1.3
Total Delay			57.0	61.3	34.2		127.8	87.2		50.5		24.0
LOS			E	E	C		F	F		D		C
Approach Delay				54.7				91.9				29.2
Approach LOS				D				F				C
Queue Length 50th (ft)			173	391	186		117	~331		207		652
Queue Length 95th (ft)			245	445	328		#249	#425		271		610
Internal Link Dist (ft)				845				314				181
Turn Bay Length (ft)			150		150		200			250		
Base Capacity (vph)			622	1461	611		110	743		600		2301
Starvation Cap Reductn			0	0	0		0	0		0		140
Spillback Cap Reductn			0	0	0		0	0		0		0
Storage Cap Reductn			0	0	0		0	0		0		0
Reduced v/c Ratio			0.66	0.72	0.63		0.96	1.08		0.82		0.92
<b>Intersection Summary</b>												
Area Type:	Other											
Cycle Length:	160											
Actuated Cycle Length:	160											
Offset:	56 (35%), Referenced to phase 6:NBT, Start of Yellow											
Natural Cycle:	125											
Control Type:	Actuated-Coordinated											
Maximum v/c Ratio:	1.08											
Intersection Signal Delay:	47.4						Intersection LOS: D					
Intersection Capacity Utilization:	85.5%						ICU Level of Service E					
Analysis Period (min):	15											
~ Volume exceeds capacity, queue is theoretically infinite. Queue shown is maximum after two cycles.												
# 95th percentile volume exceeds capacity, queue may be longer. Queue shown is maximum after two cycles.												
m Volume for 95th percentile queue is metered by upstream signal.												

Pepper Square TIA  
Lanes, Volumes, Timings

Phase 1 - 2026 Background + Site - PM  
1367: Preston & Belt Line

Splits and Phases: 1367: Preston & Belt Line

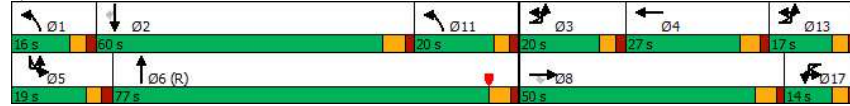

Pepper Square TIA  
Lanes, Volumes, Timings

Phase 1 - 2026 Background + Site - PM  
1367: Preston & Belt Line

Lane Group	SBL	SBT	SBR	Ø1	Ø3	Ø11	Ø13
Total Split (%)	11.9%	37.5%	37.5%	10%	13%	13%	11%
Maximum Green (s)	14.0	54.0	54.0	11.0	15.0	15.0	12.0
Yellow Time (s)	3.0	4.4	4.4	3.0	3.0	3.0	3.0
All-Red Time (s)	2.0	1.6	1.6	2.0	2.0	2.0	2.0
Lost Time Adjust (s)	-1.0	-1.7	-1.7				
Total Lost Time (s)	4.0	4.3	4.3				
Lead/Lag	Lead	Lag	Lag	Lead	Lead		
Lead-Lag Optimize?	Yes	Yes	Yes	Yes	Yes		
Vehicle Extension (s)	1.5	2.5	2.5	1.6	1.3	3.0	3.0
Recall Mode	None	Max	Max	None	None	None	None
Walk Time (s)		7.0	7.0				
Flash Dont Walk (s)		20.0	20.0				
Pedestrian Calls (#/hr)		0	0				
Act Effect Green (s)	15.0	55.7	55.7				
Actuated g/C Ratio	0.09	0.35	0.35				
v/c Ratio	0.93	0.81	0.38				
Control Delay	95.8	42.8	10.9				
Queue Delay	0.0	0.0	0.0				
Total Delay	95.8	42.8	10.9				
LOS	F	D	B				
Approach Delay		42.6					
Approach LOS		D					
Queue Length 50th (ft)	147	556	138				
Queue Length 95th (ft)	m#239	m610	m158				
Internal Link Dist (ft)		2974					
Turn Bay Length (ft)	200		300				
Base Capacity (vph)	165	1770	699				
Starvation Cap Reductn	0	0	0				
Spillback Cap Reductn	0	0	0				
Storage Cap Reductn	0	0	0				
Reduced v/c Ratio	0.93	0.81	0.38				
<b>Intersection Summary</b>							

Pepper Square TIA  
Lanes, Volumes, Timings

Phase 1 - 2026 Background + Site - PM  
1368: Preston & Alexis

Lane Group	EBL	EBT	EBR	WBL	WBT	WBR	NBU	NBL	NBT	NBR	SBL	SBT
Lane Configurations												
Traffic Volume (vph)	66	24	64	242	24	79	7	43	2274	248	154	1617
Future Volume (vph)	66	24	64	242	24	79	7	43	2274	248	154	1617
Ideal Flow (vphpl)	1900	1900	1900	1900	1900	1900	1900	1900	1900	1900	1900	1900
Storage Length (ft)	0	0	175			0		150		150	150	
Storage Lanes	1		1	2		1		1		1	1	
Taper Length (ft)	25			25				25			25	
Lane Util. Factor	0.91	0.91	1.00	0.97	1.00	1.00	0.91	1.00	0.91	1.00	1.00	0.91
Frt			0.850			0.850				0.850		
Fit Protected	0.950	0.972		0.950				0.950			0.950	
Satd. Flow (prot)	1610	3295	1583	3433	1863	1583	0	1770	5085	1583	1770	5085
Fit Permitted	0.950	0.972		0.950				0.107			0.040	
Satd. Flow (perm)	1610	3295	1583	3433	1863	1583	0	199	5085	1583	75	5085
Right Turn on Red			Yes			Yes				Yes		
Satd. Flow (RTOR)			125			85				106		
Link Speed (mph)	30				30				43			42
Link Distance (ft)	660				627				2867			173
Travel Time (s)	15.0				14.3				45.5			2.8
Peak Hour Factor	0.95	0.95	0.95	0.95	0.95	0.95	0.95	0.95	0.95	0.95	0.95	0.95
Adj. Flow (vph)	69	25	67	255	25	83	7	45	2394	261	162	1702
Shared Lane Traffic (%)	50%											
Lane Group Flow (vph)	34	60	67	255	25	83	0	52	2394	261	162	1702
Enter Blocked Intersection	No	No	No	No	No	No	No	No	No	No	No	No
Lane Alignment	Left	Left	Right	Left	Left	Right	R NA	Left	Left	Right	Left	Left
Median Width(ft)	24				24				12			12
Link Offset(ft)	0				0				0			0
Crosswalk Width(ft)	16				16				16			16
Two way Left Turn Lane												
Headway Factor	1.00	1.00	1.00	1.00	1.00	1.00	1.00	1.00	1.00	1.00	1.00	1.00
Turning Speed (mph)	15		9	15		9	9	15		9	15	
Number of Detectors	1	1	1	1	1	1	1	1	1	1	1	1
Detector Template												
Leading Detector (ft)	50	50	50	50	50	50	50	50	50	50	50	50
Trailing Detector (ft)	0	0	0	0	0	0	0	0	0	0	0	0
Detector 1 Position(ft)	0	0	0	0	0	0	0	0	0	0	0	0
Detector 1 Size(ft)	50	50	50	50	50	50	50	50	50	50	50	50
Detector 1 Type	Cl+Ex	Cl+Ex	Cl+Ex	Cl+Ex	Cl+Ex	Cl+Ex	Cl+Ex	Cl+Ex	Cl+Ex	Cl+Ex	Cl+Ex	Cl+Ex
Detector 1 Channel												
Detector 1 Extend (s)	0.0	0.0	0.0	0.0	0.0	0.0	0.0	0.0	0.0	0.0	0.0	0.0
Detector 1 Queue (s)	0.0	0.0	0.0	0.0	0.0	0.0	0.0	0.0	0.0	0.0	0.0	0.0
Detector 1 Delay (s)	0.0	0.0	0.0	0.0	0.0	0.0	0.0	0.0	0.0	0.0	0.0	0.0
Turn Type	Split	NA	Perm	Split	NA	pm+ov	D.P+P	D.P+P	NA	Perm	D.P+P	NA
Protected Phases	3	3		4	4	5	1	1	6		5	2
Permitted Phases			3			4	2	2		6		6
Detector Phase	3	3	3	4	4	5	1	1	6	6	5	2
Switch Phase												
Minimum Initial (s)	6.0	6.0	6.0	8.0	8.0	3.0	3.0	3.0	14.0	14.0	3.0	14.0
Minimum Split (s)	27.0	27.0	27.0	27.0	27.0	8.4	8.4	8.4	24.0	24.0	8.4	24.0
Total Split (s)	23.0	23.0	23.0	22.0	22.0	20.0	15.0	15.0	95.0	95.0	20.0	100.0

Pepper Square TIA  
Lanes, Volumes, Timings

Phase 1 - 2026 Background + Site - PM  
1368: Preston & Alexis

Lane Group	SBR
Lane Configurations	
Traffic Volume (vph)	23
Future Volume (vph)	23
Ideal Flow (vphpl)	1900
Storage Length (ft)	150
Storage Lanes	1
Taper Length (ft)	
Lane Util. Factor	1.00
Frt	0.850
Fit Protected	
Satd. Flow (prot)	1583
Fit Permitted	
Satd. Flow (perm)	1583
Right Turn on Red	Yes
Satd. Flow (RTOR)	78
Link Speed (mph)	
Link Distance (ft)	
Travel Time (s)	
Peak Hour Factor	0.95
Adj. Flow (vph)	24
Shared Lane Traffic (%)	
Lane Group Flow (vph)	24
Enter Blocked Intersection	No
Lane Alignment	Right
Median Width(ft)	
Link Offset(ft)	
Crosswalk Width(ft)	
Two way Left Turn Lane	
Headway Factor	1.00
Turning Speed (mph)	9
Number of Detectors	1
Detector Template	
Leading Detector (ft)	50
Trailing Detector (ft)	0
Detector 1 Position(ft)	0
Detector 1 Size(ft)	50
Detector 1 Type	Cl+Ex
Detector 1 Channel	
Detector 1 Extend (s)	0.0
Detector 1 Queue (s)	0.0
Detector 1 Delay (s)	0.0
Turn Type	Perm
Protected Phases	
Permitted Phases	2
Detector Phase	2
Switch Phase	
Minimum Initial (s)	14.0
Minimum Split (s)	24.0
Total Split (s)	100.0

Pepper Square TIA  
Lanes, Volumes, Timings

Phase 1 - 2026 Background + Site - PM  
1368: Preston & Alexis

Lane Group	EBL	EBT	EBR	WBL	WBT	WBR	NBU	NBL	NBT	NBR	SBL	SBT	
Total Split (%)	14.4%	14.4%	14.4%	13.8%	13.8%	12.5%	9.4%	9.4%	59.4%	59.4%	12.5%	62.5%	
Maximum Green (s)	18.0	18.0	18.0	17.0	17.0	15.6	10.6	10.6	89.0	89.0	15.6	94.0	
Yellow Time (s)	4.0	4.0	4.0	4.0	4.0	3.4	3.4	3.4	4.5	4.5	3.4	4.5	
All-Red Time (s)	1.0	1.0	1.0	1.0	1.0	1.0	1.0	1.0	1.5	1.5	1.0	1.5	
Lost Time Adjust (s)	-1.0	-1.0	0.0	-1.0	-1.0	0.0			-1.0	-2.0	0.0	-1.0	-2.0
Total Lost Time (s)	4.0	4.0	5.0	4.0	4.0	4.4			3.4	4.0	6.0	3.4	4.0
Lead/Lag	Lag	Lag	Lag	Lead	Lead	Lag	Lead	Lead	Lead	Lead	Lag	Lag	
Lead-Lag Optimize?	Yes	Yes	Yes	Yes	Yes	Yes	Yes	Yes	Yes	Yes	Yes	Yes	
Vehicle Extension (s)	2.0	2.0	2.0	2.0	2.0	1.2	1.2	1.2	2.5	2.5	1.2	2.5	
Recall Mode	None	None	None	None	None	None	None	None	Max	Max	None	C-Max	
Walk Time (s)	4.0	4.0	4.0	4.0	4.0				4.0	4.0		4.0	
Flash Dont Walk (s)	18.0	18.0	18.0	18.0	18.0				14.0	14.0		14.0	
Pedestrian Calls (#/hr)	0	0	0	0	0				0	0		0	
Act Effect Green (s)	9.1	9.1	8.1	16.3	16.3	35.9			120.5	102.6	100.6	119.8	115.0
Actuated g/C Ratio	0.06	0.06	0.05	0.10	0.10	0.22			0.75	0.64	0.63	0.75	0.72
v/c Ratio	0.37	0.32	0.34	0.73	0.13	0.20			0.25	0.73	0.25	0.70	0.47
Control Delay	83.4	76.3	4.5	82.4	66.2	9.6			7.5	17.8	6.3	41.0	3.2
Queue Delay	0.0	0.0	0.0	0.0	0.0	0.0			0.0	0.0	0.0	0.0	0.0
Total Delay	83.4	76.3	4.5	82.4	66.2	9.6			7.5	17.8	6.3	41.0	3.2
LOS	F	E	A	F	E	A			A	B	A	D	A
Approach Delay			47.9			64.6					16.5		6.4
Approach LOS			D			E					B		A
Queue Length 50th (ft)	38	34	0	135	24	0			10	508	42	121	94
Queue Length 95th (ft)	80	60	0	185	57	45			20	673	72	#213	91
Internal Link Dist (ft)			580			547					2787		93
Turn Bay Length (ft)					175				150		150		150
Base Capacity (vph)	191	391	289	386	209	420			267	3260	1034	231	3654
Starvation Cap Reductn	0	0	0	0	0	0			0	0	0	0	0
Spillback Cap Reductn	0	0	0	0	0	0			0	0	0	0	0
Storage Cap Reductn	0	0	0	0	0	0			0	0	0	0	0
Reduced v/c Ratio	0.18	0.15	0.23	0.66	0.12	0.20			0.19	0.73	0.25	0.70	0.47

Intersection Summary

Area Type: Other

Cycle Length: 160

Actuated Cycle Length: 160

Offset: 63 (39%), Referenced to phase 2:NBSB, Start of Yellow

Natural Cycle: 130

Control Type: Actuated-Coordinated

Maximum v/c Ratio: 0.73

Intersection Signal Delay: 17.2 Intersection LOS: B

Intersection Capacity Utilization 76.0% ICU Level of Service D

Analysis Period (min) 15

# 95th percentile volume exceeds capacity, queue may be longer.  
Queue shown is maximum after two cycles.

m Volume for 95th percentile queue is metered by upstream signal.

Splits and Phases: 1368: Preston & Alexis

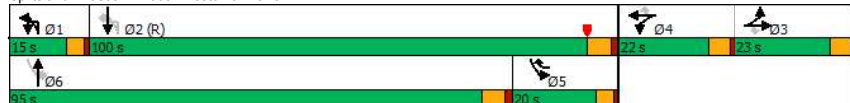

Pepper Square TIA  
Lanes, Volumes, Timings

Phase 1 - 2026 Background + Site - PM  
1368: Preston & Alexis

Lane Group	SBR
Total Split (%)	62.5%
Maximum Green (s)	94.0
Yellow Time (s)	4.5
All-Red Time (s)	1.5
Lost Time Adjust (s)	0.0
Total Lost Time (s)	6.0
Lead/Lag	Lag
Lead-Lag Optimize?	Yes
Vehicle Extension (s)	2.5
Recall Mode	C-Max
Walk Time (s)	4.0
Flash Dont Walk (s)	14.0
Pedestrian Calls (#/hr)	0
Act Effect Green (s)	113.0
Actuated g/C Ratio	0.71
v/c Ratio	0.02
Control Delay	0.0
Queue Delay	0.0
Total Delay	0.0
LOS	A
Approach Delay	
Approach LOS	
Queue Length 50th (ft)	0
Queue Length 95th (ft)	m0
Internal Link Dist (ft)	
Turn Bay Length (ft)	150
Base Capacity (vph)	1141
Starvation Cap Reductn	0
Spillback Cap Reductn	0
Storage Cap Reductn	0
Reduced v/c Ratio	0.02

Intersection Summary

09/22/2022 11:11 am  
Kimley-Horn



Pepper Square TIA  
Lanes, Volumes, Timings

Phase 1 - 2026 Background + Site - PM  
1369: Preston & Belt Line Village Driveway



Lane Group	EBL	EBT	EBR	WBL	WBT	WBR	NBU	NBL	NBT	NBR	SBU	SBL
Lane Configurations		↑↑		↑	↑			↑	↑↑↑			↑
Traffic Volume (vph)	79	5	53	25	6	18	1	67	2223	12	8	57
Future Volume (vph)	79	5	53	25	6	18	1	67	2223	12	8	57
Ideal Flow (vphpl)	1900	1900	1900	1900	1900	1900	1900	1900	1900	1900	1900	1900
Storage Length (ft)	0	0	0	0	0	0	0	100	0	0	0	100
Storage Lanes	0	0	0	1	0	0	0	1	0	0	0	1
Taper Length (ft)	25			25				25				25
Lane Util. Factor	0.95	0.95	0.95	1.00	1.00	1.00	0.91	1.00	0.91	0.91	0.91	1.00
Frt		0.941				0.886			0.999			
Fit Protected		0.972		0.950				0.950				0.950
Satd. Flow (prot)	0	3237	0	1770	1650	0	0	1770	5080	0	0	1770
Fit Permitted		0.789		0.591				0.081				0.048
Satd. Flow (perm)	0	2628	0	1101	1650	0	0	151	5080	0	0	89
Right Turn on Red			Yes		Yes					Yes		
Satd. Flow (RTOR)		55		19				1				
Link Speed (mph)		30		30				42				
Link Distance (ft)		303		249				252				
Travel Time (s)		6.9		5.7				4.1				
Peak Hour Factor	0.97	0.97	0.97	0.97	0.97	0.97	0.97	0.97	0.97	0.97	0.97	0.97
Adj. Flow (vph)	81	5	55	26	6	19	1	69	2292	12	8	59
Shared Lane Traffic (%)												
Lane Group Flow (vph)	0	141	0	26	25	0	0	70	2304	0	0	67
Enter Blocked Intersection	No	No	No	No	No	No	No	No	No	No	No	No
Lane Alignment	Left	Left	Right	Left	Left	Right	R NA	Left	Left	Right	R NA	Left
Median Width(ft)		12		12				12				12
Link Offset(ft)		0		0				0				0
Crosswalk Width(ft)		16		16				16				16
Two way Left Turn Lane												
Headway Factor	1.00	1.00	1.00	1.00	1.00	1.00	1.00	1.00	1.00	1.00	1.00	1.00
Turning Speed (mph)	15		9	15		9	9	15		9	9	15
Number of Detectors	1	1		1	1		1	1	1		1	1
Detector Template												
Leading Detector (ft)	50	50		50	50		50	50	50		50	50
Trailing Detector (ft)	0	0		0	0		0	0	0		0	0
Detector 1 Position(ft)	0	0		0	0		0	0	0		0	0
Detector 1 Size(ft)	50	50		50	50		50	50	50		50	50
Detector 1 Type	CI+Ex	CI+Ex		CI+Ex	CI+Ex		CI+Ex	CI+Ex	CI+Ex		CI+Ex	CI+Ex
Detector 1 Channel												
Detector 1 Extend (s)	0.0	0.0		0.0	0.0		0.0	0.0	0.0		0.0	0.0
Detector 1 Queue (s)	0.0	0.0		0.0	0.0		0.0	0.0	0.0		0.0	0.0
Detector 1 Delay (s)	0.0	0.0		0.0	0.0		0.0	0.0	0.0		0.0	0.0
Turn Type	Perm	NA		Perm	NA		custom	D.P+P	NA		custom	D.P+P
Protected Phases		8		4	4		1	2		6		5
Permitted Phases	8			4			1		2		5	6
Detector Phase	8	8		4	4		1	1	6		5	5
Switch Phase												
Minimum Initial (s)	20.0	20.0		20.0	20.0		5.0	5.0	20.0		5.0	5.0
Minimum Split (s)	25.0	25.0		25.0	25.0		10.0	10.0	26.0		10.0	10.0
Total Split (s)	47.0	47.0		47.0	47.0		20.0	20.0	98.0		15.0	15.0

Pepper Square TIA  
Lanes, Volumes, Timings

Phase 1 - 2026 Background + Site - PM  
1369: Preston & Belt Line Village Driveway



Lane Group	SBT	SBR
Lane Configurations	↑↑↑	
Traffic Volume (vph)	1864	26
Future Volume (vph)	1864	26
Ideal Flow (vphpl)	1900	1900
Storage Length (ft)	0	0
Storage Lanes	0	0
Taper Length (ft)		
Lane Util. Factor	0.91	0.91
Frt	0.998	
Fit Protected		
Satd. Flow (prot)	5075	0
Fit Permitted		
Satd. Flow (perm)	5075	0
Right Turn on Red		Yes
Satd. Flow (RTOR)	2	
Link Speed (mph)	38	
Link Distance (ft)	191	
Travel Time (s)	3.4	
Peak Hour Factor	0.97	0.97
Adj. Flow (vph)	1922	27
Shared Lane Traffic (%)		
Lane Group Flow (vph)	1949	0
Enter Blocked Intersection	No	No
Lane Alignment	Left	Right
Median Width(ft)	12	
Link Offset(ft)	0	
Crosswalk Width(ft)	16	
Two way Left Turn Lane		
Headway Factor	1.00	1.00
Turning Speed (mph)		9
Number of Detectors	1	
Detector Template		
Leading Detector (ft)	50	
Trailing Detector (ft)	0	
Detector 1 Position(ft)	0	
Detector 1 Size(ft)	50	
Detector 1 Type	CI+Ex	
Detector 1 Channel		
Detector 1 Extend (s)	0.0	
Detector 1 Queue (s)	0.0	
Detector 1 Delay (s)	0.0	
Turn Type	NA	
Protected Phases	2	
Permitted Phases		
Detector Phase	2	
Switch Phase		
Minimum Initial (s)	20.0	
Minimum Split (s)	26.0	
Total Split (s)	93.0	

Pepper Square TIA  
Lanes, Volumes, Timings

Phase 1 - 2026 Background + Site - PM  
1369: Preston & Belt Line Village Driveway



Lane Group	EBL	EBT	EBR	WBL	WBT	WBR	NBU	NBL	NBT	NBR	SBU	SBL
Total Split (%)	29.4%	29.4%		29.4%	29.4%		12.5%	12.5%	61.3%		9.4%	9.4%
Maximum Green (s)	42.3	42.3		42.3	42.3		15.0	15.0	93.7		10.0	10.0
Yellow Time (s)	3.0	3.0		3.0	3.0		3.0	3.0	3.0		3.0	3.0
All-Red Time (s)	1.7	1.7		1.7	1.7		2.0	2.0	1.3		2.0	2.0
Lost Time Adjust (s)		-1.0		-1.0	-1.0			-1.0	-2.0			-1.0
Total Lost Time (s)		3.7		3.7	3.7			4.0	2.3			4.0
Lead/Lag							Lead	Lead	Lead		Lag	Lag
Lead-Lag Optimize?							Yes	Yes	Yes		Yes	Yes
Vehicle Extension (s)	2.0	2.0		2.0	2.0		1.5	1.5	3.0		1.5	1.5
Recall Mode	None	None		None	None		None	None	Max		None	None
Walk Time (s)	5.0	5.0		5.0	5.0				7.0			
Flash Dont Walk (s)	15.0	15.0		15.0	15.0				8.0			
Pedestrian Calls (#/hr)	0	0		0	0				0			
Act Effect Green (s)		21.0		21.0	21.0		127.3	118.0				127.3
Actuated g/C Ratio		0.13		0.13	0.13		0.80	0.74				0.80
v/c Ratio		0.36		0.18	0.11		0.36	0.62				0.36
Control Delay		41.1		65.5	29.3		12.3	2.0				25.6
Queue Delay		0.0		0.0	0.0		0.0	0.2				0.0
Total Delay		41.1		65.5	29.3		12.3	2.2				25.6
LOS		D		E	C		B	A				C
Approach Delay		41.1			47.7			2.5				
Approach LOS		D			D			A				
Queue Length 50th (ft)		43		25	6		3	43				24
Queue Length 95th (ft)		81		58	37		m16	43				m39
Internal Link Dist (ft)		223			169			172				
Turn Bay Length (ft)							100					100
Base Capacity (vph)		751		297	460		285	3746				186
Starvation Cap Reductn		0		0	0		0	552				0
Spillback Cap Reductn		2		0	0		0	410				0
Storage Cap Reductn		0		0	0		0	0				0
Reduced v/c Ratio		0.19		0.09	0.05		0.25	0.72				0.36

Intersection Summary

Area Type: Other  
 Cycle Length: 160  
 Actuated Cycle Length: 160  
 Offset: 86 (54%), Referenced to phase 2:NBSB, Start of Yellow  
 Natural Cycle: 70  
 Control Type: Actuated-Coordinated  
 Maximum v/c Ratio: 0.62  
 Intersection Signal Delay: 4.8 Intersection LOS: A  
 Intersection Capacity Utilization 74.1% ICU Level of Service D  
 Analysis Period (min) 15  
 m Volume for 95th percentile queue is metered by upstream signal.

Splits and Phases: 1369: Preston & Belt Line Village Driveway

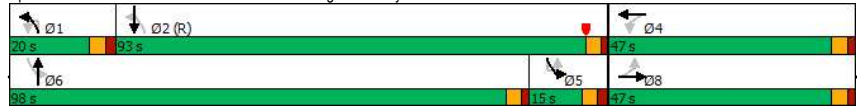

Pepper Square TIA  
Lanes, Volumes, Timings

Phase 1 - 2026 Background + Site - PM  
1369: Preston & Belt Line Village Driveway



Lane Group	SBT	SBR
Total Split (%)	58.1%	
Maximum Green (s)	88.7	
Yellow Time (s)	3.0	
All-Red Time (s)	1.3	
Lost Time Adjust (s)	-2.0	
Total Lost Time (s)	2.3	
Lead/Lag	Lag	
Lead-Lag Optimize?	Yes	
Vehicle Extension (s)	3.3	
Recall Mode	C-Max	
Walk Time (s)	7.0	
Flash Dont Walk (s)	8.0	
Pedestrian Calls (#/hr)	0	
Act Effect Green (s)	121.5	
Actuated g/C Ratio	0.76	
v/c Ratio	0.51	
Control Delay	2.7	
Queue Delay	0.3	
Total Delay	3.0	
LOS	A	
Approach Delay	3.8	
Approach LOS	A	
Queue Length 50th (ft)	47	
Queue Length 95th (ft)	m129	
Internal Link Dist (ft)	111	
Turn Bay Length (ft)		
Base Capacity (vph)	3854	
Starvation Cap Reductn	1029	
Spillback Cap Reductn	0	
Storage Cap Reductn	0	
Reduced v/c Ratio	0.69	

Intersection Summary

Area Type: Other  
 Cycle Length: 160  
 Actuated Cycle Length: 160  
 Offset: 86 (54%), Referenced to phase 2:NBSB, Start of Yellow  
 Natural Cycle: 70  
 Control Type: Actuated-Coordinated  
 Maximum v/c Ratio: 0.62  
 Intersection Signal Delay: 4.8 Intersection LOS: A  
 Intersection Capacity Utilization 74.1% ICU Level of Service D  
 Analysis Period (min) 15  
 m Volume for 95th percentile queue is metered by upstream signal.

Pepper Square TIA  
Lanes, Volumes, Timings

Phase 1 - 2026 Background + Site - PM  
1371: Preston & Spring Valley



Lane Group	EBL	EBT	EBR	WBL	WBT	WBR	NBU	NBL	NBT	NBR	SBU	SBL
Lane Configurations	↑↑	↑↑↑		↑↑	↑↑↑			↑↑	↑↑↑			↑↑
Traffic Volume (vph)	300	779	222	103	479	158	1	189	2183	196	6	158
Future Volume (vph)	300	779	222	103	479	158	1	189	2183	196	6	158
Ideal Flow (vphpl)	1900	1900	1900	1900	1900	1900	1900	1900	1900	1900	1900	1900
Storage Length (ft)	225		0	225		0		225		0		275
Storage Lanes	2		0	2		0		2		0		2
Taper Length (ft)	25			25				25				25
Lane Util. Factor	0.97	0.91	0.91	0.97	0.91	0.91	0.91	0.97	0.91	0.91	0.91	0.97
Frt		0.967			0.963				0.988			
Fit Protected	0.950			0.950				0.950				0.950
Satd. Flow (prot)	3433	4917	0	3433	4897	0	0	3433	5024	0	0	3433
Fit Permitted	0.950			0.950				0.950				0.950
Satd. Flow (perm)	3433	4917	0	3433	4897	0	0	3433	5024	0	0	3433
Right Turn on Red			Yes			Yes				Yes		
Satd. Flow (RTOR)		45			42				13			
Link Speed (mph)		38			42				41			
Link Distance (ft)		3259			5488				2139			
Travel Time (s)		58.5			89.1				35.6			
Peak Hour Factor	0.94	0.94	0.94	0.94	0.94	0.94	0.94	0.94	0.94	0.94	0.94	0.94
Adj. Flow (vph)	319	829	236	110	510	168	1	201	2322	209	6	168
Shared Lane Traffic (%)												
Lane Group Flow (vph)	319	1065	0	110	678	0	0	202	2531	0	0	174
Enter Blocked Intersection	No	No	No	No	No	No	No	No	No	No	No	No
Lane Alignment	Left	Left	Right	Left	Left	Right	R NA	Left	Left	Right	R NA	Left
Median Width(ft)		24			24				24			
Link Offset(ft)		0			0				0			
Crosswalk Width(ft)		16			16				16			
Two way Left Turn Lane												
Headway Factor	1.00	1.00	1.00	1.00	1.00	1.00	1.00	1.00	1.00	1.00	1.00	1.00
Turning Speed (mph)	15		9	15		9	9	15		9	9	15
Number of Detectors	1	1		1	1		1	1	1		1	1
Detector Template												
Leading Detector (ft)	50	50		50	50		50	50	50		50	50
Trailing Detector (ft)	0	0		0	0		0	0	0		0	0
Detector 1 Position(ft)	0	0		0	0		0	0	0		0	0
Detector 1 Size(ft)	50	50		50	50		50	50	50		50	50
Detector 1 Type	Cl+Ex	Cl+Ex		Cl+Ex	Cl+Ex		Cl+Ex	Cl+Ex	Cl+Ex		Cl+Ex	Cl+Ex
Detector 1 Channel												
Detector 1 Extend (s)	0.0	0.0		0.0	0.0		0.0	0.0	0.0		0.0	0.0
Detector 1 Queue (s)	0.0	0.0		0.0	0.0		0.0	0.0	0.0		0.0	0.0
Detector 1 Delay (s)	0.0	0.0		0.0	0.0		0.0	0.0	0.0		0.0	0.0
Turn Type	Prot	NA		Prot	NA		Prot	Prot	NA		Prot	Prot
Protected Phases	3	8		7	4		1	1	6		5	5
Permitted Phases												
Detector Phase	3	8		7	4		1	1	6		5	5
Switch Phase												
Minimum Initial (s)	6.0	12.0		3.0	12.0		3.0	3.0	13.0		3.0	3.0
Minimum Split (s)	11.0	27.5		11.0	27.5		11.0	11.0	28.0		11.0	11.0
Total Split (s)	40.0	50.0		13.0	23.0		22.0	22.0	82.0		15.0	15.0

Pepper Square TIA  
Lanes, Volumes, Timings

Phase 1 - 2026 Background + Site - PM  
1371: Preston & Spring Valley



Lane Group	SBT	SBR
Lane Configurations	↑↑↑	
Traffic Volume (vph)	1556	191
Future Volume (vph)	1556	191
Ideal Flow (vphpl)	1900	1900
Storage Length (ft)		0
Storage Lanes		0
Taper Length (ft)		
Lane Util. Factor	0.91	0.91
Frt	0.984	
Fit Protected		
Satd. Flow (prot)	5004	0
Fit Permitted		
Satd. Flow (perm)	5004	0
Right Turn on Red		Yes
Satd. Flow (RTOR)	17	
Link Speed (mph)	38	
Link Distance (ft)	1208	
Travel Time (s)	21.7	
Peak Hour Factor	0.94	0.94
Adj. Flow (vph)	1655	203
Shared Lane Traffic (%)		
Lane Group Flow (vph)	1858	0
Enter Blocked Intersection	No	No
Lane Alignment	Left	Right
Median Width(ft)	24	
Link Offset(ft)	0	
Crosswalk Width(ft)	16	
Two way Left Turn Lane		
Headway Factor	1.00	1.00
Turning Speed (mph)		9
Number of Detectors	1	
Detector Template		
Leading Detector (ft)	50	
Trailing Detector (ft)	0	
Detector 1 Position(ft)	0	
Detector 1 Size(ft)	50	
Detector 1 Type	Cl+Ex	
Detector 1 Channel		
Detector 1 Extend (s)	0.0	
Detector 1 Queue (s)	0.0	
Detector 1 Delay (s)	0.0	
Turn Type	NA	
Protected Phases	2	
Permitted Phases		
Detector Phase	2	
Switch Phase		
Minimum Initial (s)	18.0	
Minimum Split (s)	28.0	
Total Split (s)	75.0	

Pepper Square TIA  
Lanes, Volumes, Timings

Phase 1 - 2026 Background + Site - PM  
1371: Preston & Spring Valley

Lane Group	EBL	EBT	EBR	WBL	WBT	WBR	NBU	NBL	NBT	NBR	SBU	SBL
Total Split (%)	25.0%	31.3%	8.1%	14.4%			13.8%	13.8%	51.3%		9.4%	9.4%
Maximum Green (s)	35.0	44.5	8.0	17.5			17.0	17.0	76.0		10.0	10.0
Yellow Time (s)	3.0	4.0	3.0	4.0			3.0	3.0	4.5		3.0	3.0
All-Red Time (s)	2.0	1.5	2.0	1.5			2.0	2.0	1.5		2.0	2.0
Lost Time Adjust (s)	-1.0	-1.5	-1.0	-1.5			-1.0	-2.0			-1.0	
Total Lost Time (s)	4.0	4.0	4.0	4.0			4.0	4.0			4.0	
Lead/Lag	Lead	Lead	Lag	Lag			Lead	Lead	Lead		Lag	Lag
Lead-Lag Optimize?	Yes	Yes	Yes	Yes			Yes	Yes	Yes		Yes	Yes
Vehicle Extension (s)	0.8	2.0	0.8	2.0			0.8	0.8	2.5		0.8	0.8
Recall Mode	None	Max	None	Max			None	None	None		None	None
Walk Time (s)		4.0		4.0					4.0			
Flash Dont Walk (s)		18.0		18.0					18.0			
Pedestrian Calls (#/hr)		0		0					0			
Act Effect Green (s)	19.2	46.0	9.0	35.8			13.6	78.0			11.0	
Actuated g/C Ratio	0.12	0.29	0.06	0.22			0.08	0.49			0.07	
v/c Ratio	0.78	0.74	0.57	0.60			0.69	1.03			0.74	
Control Delay	76.5	51.2	70.9	48.9			82.8	68.5			73.3	
Queue Delay	0.0	0.0	0.0	0.0			0.0	0.0			0.0	
Total Delay	76.5	51.2	70.9	48.9			82.8	68.5			73.3	
LOS	E	D	E	D			F	E			E	
Approach Delay		57.0		51.9				69.5				
Approach LOS		E		D				E				
Queue Length 50th (ft)	167	372	60	227			112	~1001			93	
Queue Length 95th (ft)	218	417	m57	m232			m155	#1089			m124	
Internal Link Dist (ft)		3179		5408				2059				
Turn Bay Length (ft)	225		225				225				275	
Base Capacity (vph)	772	1445	193	1128			386	2455			236	
Starvation Cap Reductn	0	0	0	0			0	0			0	
Spillback Cap Reductn	0	0	0	0			0	0			0	
Storage Cap Reductn	0	0	0	0			0	0			0	
Reduced v/c Ratio	0.41	0.74	0.57	0.60			0.52	1.03			0.74	

Intersection Summary

Area Type:	Other
Cycle Length:	160
Actuated Cycle Length:	160
Offset:	135 (84%), Referenced to phase 2:SBT, Start of Yellow
Natural Cycle:	110
Control Type:	Actuated-Coordinated
Maximum v/c Ratio:	1.03
Intersection Signal Delay:	53.3
Intersection LOS:	D
Intersection Capacity Utilization:	87.9%
ICU Level of Service:	E
Analysis Period (min):	15
~	Volume exceeds capacity, queue is theoretically infinite. Queue shown is maximum after two cycles.
#	95th percentile volume exceeds capacity, queue may be longer. Queue shown is maximum after two cycles.
m	Volume for 95th percentile queue is metered by upstream signal.

Pepper Square TIA  
Lanes, Volumes, Timings

Phase 1 - 2026 Background + Site - PM  
1371: Preston & Spring Valley

Splits and Phases: 1371: Preston & Spring Valley

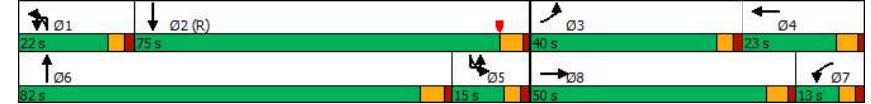

Pepper Square TIA  
Lanes, Volumes, Timings

Phase 1 - 2026 Background + Site - PM  
1371: Preston & Spring Valley

Lane Group	SBT	SBR
Total Split (%)	46.9%	
Maximum Green (s)	69.0	
Yellow Time (s)	4.5	
All-Red Time (s)	1.5	
Lost Time Adjust (s)	-2.0	
Total Lost Time (s)	4.0	
Lead/Lag	Lag	
Lead-Lag Optimize?	Yes	
Vehicle Extension (s)	2.4	
Recall Mode	C-Max	
Walk Time (s)	4.0	
Flash Dont Walk (s)	18.0	
Pedestrian Calls (#/hr)	0	
Act Effect Green (s)	75.4	
Actuated g/C Ratio	0.47	
v/c Ratio	0.79	
Control Delay	25.3	
Queue Delay	0.0	
Total Delay	25.3	
LOS	C	
Approach Delay	29.4	
Approach LOS	C	
Queue Length 50th (ft)	249	
Queue Length 95th (ft)	542	
Internal Link Dist (ft)	1128	
Turn Bay Length (ft)		
Base Capacity (vph)	2366	
Starvation Cap Reductn	0	
Spillback Cap Reductn	0	
Storage Cap Reductn	0	
Reduced v/c Ratio	0.79	
<b>Intersection Summary</b>		

Pepper Square TIA  
Lanes, Volumes, Timings

Phase 1 - 2026 Background + Site - PM  
1405: Prestonwood & Belt Line

Lane Group	EBU	EBL	EBT	EBR	WBU	WBL	WBT	WBR	NBL	NBT	NBR	SBL
Lane Configurations		↑↑	↑↑↑			↑↑	↑↑↑			↑↑		↑↑
Traffic Volume (vph)	7	79	1598	7	3	2	1299	105	6	1	2	150
Future Volume (vph)	7	79	1598	7	3	2	1299	105	6	1	2	150
Ideal Flow (vphpl)	1900	1900	1900	1900	1900	1900	1900	1900	1900	1900	1900	1900
Storage Length (ft)		200		0		200		0	0		0	300
Storage Lanes		1		0		1		0	0		0	2
Taper Length (ft)		25				25			25			25
Lane Util. Factor	0.91	1.00	0.91	0.91	0.91	1.00	0.91	0.91	1.00	1.00	1.00	0.97
Frt			0.999				0.989				0.970	
Fit Protected		0.950				0.950				0.968		0.950
Satd. Flow (prot)	0	1770	5080	0	0	1770	5029	0	0	1749	0	3433
Fit Permitted		0.076				0.118				0.968		0.950
Satd. Flow (perm)	0	142	5080	0	0	220	5029	0	0	1749	0	3433
Right Turn on Red			Yes				Yes			Yes		Yes
Satd. Flow (RTOR)			1				12			2		
Link Speed (mph)			42				42			30		
Link Distance (ft)			1445				2036			315		
Travel Time (s)			23.5				33.1			7.2		
Peak Hour Factor	0.95	0.95	0.95	0.95	0.95	0.95	0.95	0.95	0.95	0.95	0.95	0.95
Adj. Flow (vph)	7	83	1682	7	3	2	1367	111	6	1	2	158
Shared Lane Traffic (%)												
Lane Group Flow (vph)	0	90	1689	0	0	5	1478	0	0	9	0	158
Enter Blocked Intersection	No	No	No	No	No	No	No	No	No	No	No	No
Lane Alignment	R NA	Left	Left	Right	R NA	Left	Left	Right	Left	Left	Right	Left
Median Width(ft)			24				24			24		
Link Offset(ft)			0				0			0		
Crosswalk Width(ft)			16				16			16		
Two way Left Turn Lane												
Headway Factor	1.00	1.00	1.00	1.00	1.00	1.00	1.00	1.00	1.00	1.00	1.00	1.00
Turning Speed (mph)	9	15		9	9	15		9	15		9	15
Number of Detectors	1	1	1		1	1	1		1	1		1
Detector Template												
Leading Detector (ft)	50	50	50		50	50	50		50	50		50
Trailing Detector (ft)	0	0	0		0	0	0		0	0		0
Detector 1 Position(ft)	0	0	0		0	0	0		0	0		0
Detector 1 Size(ft)	50	50	50		50	50	50		50	50		50
Detector 1 Type	CI+Ex	CI+Ex	CI+Ex		CI+Ex	CI+Ex	CI+Ex		CI+Ex	CI+Ex		CI+Ex
Detector 1 Channel												
Detector 1 Extend (s)	0.0	0.0	0.0		0.0	0.0	0.0		0.0	0.0		0.0
Detector 1 Queue (s)	0.0	0.0	0.0		0.0	0.0	0.0		0.0	0.0		0.0
Detector 1 Delay (s)	0.0	0.0	0.0		0.0	0.0	0.0		0.0	0.0		0.0
Turn Type	D,P+P	D,P+P	NA		D,P+P	D,P+P	NA		Split	NA		Split
Protected Phases	1	1	6		5	5	2		3	3		4
Permitted Phases	2	2			6	6						
Detector Phase	1	1	6		5	5	2		3	3		4
Switch Phase												
Minimum Initial (s)	3.0	3.0	15.0		3.0	3.0	15.0		5.0	5.0		7.0
Minimum Split (s)	8.0	8.0	22.0		8.0	8.0	24.0		23.0	23.0		23.2
Total Split (s)	25.0	25.0	99.0		15.0	15.0	89.0		18.0	18.0		28.0

Pepper Square TIA  
Lanes, Volumes, Timings

Phase 1 - 2026 Background + Site - PM  
1405: Prestonwood & Belt Line

Lane Group	SBT	SBR
Lane Configurations	↓	↑
Traffic Volume (vph)	2	82
Future Volume (vph)	2	82
Ideal Flow (vphpl)	1900	1900
Storage Length (ft)		0
Storage Lanes		1
Taper Length (ft)		
Lane Util. Factor	0.95	0.95
Frt	0.857	0.850
Fit Protected		
Satd. Flow (prot)	1517	1504
Fit Permitted		
Satd. Flow (perm)	1517	1504
Right Turn on Red		Yes
Satd. Flow (RTOR)	42	89
Link Speed (mph)	30	
Link Distance (ft)	868	
Travel Time (s)	19.7	
Peak Hour Factor	0.95	0.95
Adj. Flow (vph)	2	86
Shared Lane Traffic (%)		49%
Lane Group Flow (vph)	44	44
Enter Blocked Intersection	No	No
Lane Alignment	Left	Right
Median Width(ft)	24	
Link Offset(ft)	0	
Crosswalk Width(ft)	16	
Two way Left Turn Lane		
Headway Factor	1.00	1.00
Turning Speed (mph)		9
Number of Detectors	1	1
Detector Template		
Leading Detector (ft)	50	50
Trailing Detector (ft)	0	0
Detector 1 Position(ft)	0	0
Detector 1 Size(ft)	50	50
Detector 1 Type	CI+Ex	CI+Ex
Detector 1 Channel		
Detector 1 Extend (s)	0.0	0.0
Detector 1 Queue (s)	0.0	0.0
Detector 1 Delay (s)	0.0	0.0
Turn Type	NA	custom
Protected Phases	4	
Permitted Phases		1 4
Detector Phase	4	1 4
Switch Phase		
Minimum Initial (s)	7.0	
Minimum Split (s)	23.2	
Total Split (s)	28.0	

Pepper Square TIA  
Lanes, Volumes, Timings

Phase 1 - 2026 Background + Site - PM  
1405: Prestonwood & Belt Line

Lane Group	EBU	EBL	EBT	EBR	WBU	WBL	WBT	WBR	NBL	NBT	NBR	SBL
Total Split (%)	15.6%	15.6%	61.9%		9.4%	9.4%	55.6%		11.3%	11.3%		17.5%
Maximum Green (s)	20.0	20.0	93.0		10.0	10.0	83.0		13.0	13.0		22.8
Yellow Time (s)	3.0	3.0	4.5		3.0	3.0	4.5		3.0	3.0		3.2
All-Red Time (s)	2.0	2.0	1.5		2.0	2.0	1.5		2.0	2.0		2.0
Lost Time Adjust (s)		-1.0	-2.0			-1.0	-2.0			-1.0		-1.2
Total Lost Time (s)		4.0	4.0			4.0	4.0			4.0		4.0
Lead/Lag	Lag	Lag	Lag		Lead	Lead	Lead		Lead	Lead		Lag
Lead-Lag Optimize?	Yes	Yes	Yes		Yes	Yes	Yes		Yes	Yes		Yes
Vehicle Extension (s)	1.0	1.0	2.5		1.0	1.0	2.5		1.5	1.5		1.5
Recall Mode	None	None	C-Max		None	None	None		None	None		None
Walk Time (s)			5.0				4.0		4.0	4.0		4.0
Flash Dont Walk (s)			10.0				14.0		14.0	14.0		14.0
Pedestrian Calls (#/hr)			0				0		0	0		0
Act Effect Green (s)		131.3	133.5			134.5	74.4			6.3		12.5
Actuated g/C Ratio		0.82	0.83			0.84	0.46			0.04		0.08
v/c Ratio		0.13	0.40			0.02	0.63			0.13		0.59
Control Delay		16.5	4.7			0.8	20.8			67.0		80.2
Queue Delay		0.0	0.0			0.0	0.0			0.0		0.0
Total Delay		16.5	4.7			0.8	20.8			67.0		80.2
LOS		B	A			A	C			E		F
Approach Delay			5.3				20.8			67.0		
Approach LOS			A				C			E		
Queue Length 50th (ft)		10	43			0	169			7		84
Queue Length 95th (ft)		52	393			m1	m308			28		121
Internal Link Dist (ft)			1365				1956			235		
Turn Bay Length (ft)		200				200						300
Base Capacity (vph)		695	4238			292	2677			154		514
Starvation Cap Reductn		0	0			0	0			0		0
Spillback Cap Reductn		0	0			0	0			0		0
Storage Cap Reductn		0	0			0	0			0		0
Reduced v/c Ratio		0.13	0.40			0.02	0.55			0.06		0.31

**Intersection Summary**  
 Area Type: Other  
 Cycle Length: 160  
 Actuated Cycle Length: 160  
 Offset: 60 (38%), Referenced to phase 6:EBWB, Start of Yellow  
 Natural Cycle: 90  
 Control Type: Actuated-Coordinated  
 Maximum v/c Ratio: 0.63  
 Intersection Signal Delay: 15.5  
 Intersection LOS: B  
 Intersection Capacity Utilization 53.1%  
 ICU Level of Service A  
 Analysis Period (min) 15  
 m Volume for 95th percentile queue is metered by upstream signal.

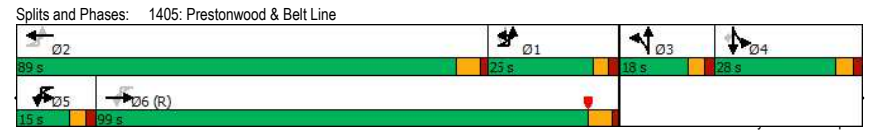

Pepper Square TIA  
Lanes, Volumes, Timings

Phase 1 - 2026 Background + Site - PM  
1405: Prestonwood & Belt Line



Lane Group	SBT	SBR
Total Split (%)	17.5%	
Maximum Green (s)	22.8	
Yellow Time (s)	3.2	
All-Red Time (s)	2.0	
Lost Time Adjust (s)	-1.2	
Total Lost Time (s)	4.0	
Lead/Lag	Lag	
Lead-Lag Optimize?	Yes	
Vehicle Extension (s)	1.5	
Recall Mode	None	
Walk Time (s)	4.0	
Flash Dont Walk (s)	14.0	
Pedestrian Calls (#/hr)	0	
Act Effect Green (s)	12.5	71.8
Actuated g/C Ratio	0.08	0.45
v/c Ratio	0.28	0.06
Control Delay	23.6	0.2
Queue Delay	0.0	0.0
Total Delay	23.6	0.2
LOS	C	A
Approach Delay	55.8	
Approach LOS	E	
Queue Length 50th (ft)	2	0
Queue Length 95th (ft)	46	0
Internal Link Dist (ft)	788	
Turn Bay Length (ft)		
Base Capacity (vph)	263	825
Starvation Cap Reductn	0	0
Spillback Cap Reductn	0	0
Storage Cap Reductn	0	0
Reduced v/c Ratio	0.17	0.05

Intersection Summary

Pepper Square TIA  
HCM 6th TWSC

Phase 1 - 2026 Background + Site - PM  
2: Ladera Drive & Belt Line

Intersection												
Int Delay, s/veh	5											
Movement	EBL	EBT	EBR	WBL	WBT	WBR	NBL	NBT	NBR	SBL	SBT	SBR
Lane Configurations	↔ ↑↑↑			↔ ↑↑↑			↔ ↑↑			↔ ↑↑		
Traffic Vol, veh/h	115	1632	56	76	1291	63	16	1	48	26	1	71
Future Vol, veh/h	115	1632	56	76	1291	63	16	1	48	26	1	71
Conflicting Peds, #/hr	0	0	0	0	0	0	0	0	0	0	0	0
Sign Control	Free	Free	Free	Free	Free	Stop	Stop	Stop	Stop	Stop	Stop	Stop
RT Channelized	-	-	None	-	-	None	-	-	None	-	-	None
Storage Length	100	-	-	100	-	-	-	-	0	-	-	0
Veh in Median Storage, #	-	0	-	-	0	-	-	-	1	-	-	1
Grade, %	-	0	-	-	0	-	-	-	0	-	-	0
Peak Hour Factor	96	96	96	96	96	96	96	96	96	96	96	96
Heavy Vehicles, %	2	2	2	2	2	2	2	2	2	2	2	2
Mvmt Flow	120	1700	58	79	1345	66	17	1	50	27	1	74

Major/Minor	Major1	Major2	Minor1	Minor2
Conflicting Flow All	1411	0	0	1758
Stage 1	-	-	-	-
Stage 2	-	-	-	-
Critical Hdwy	5.34	-	-	5.34
Critical Hdwy Stg 1	-	-	-	-
Critical Hdwy Stg 2	-	-	-	-
Follow-up Hdwy	3.12	-	-	3.12
Pot Cap-1 Maneuver	247	-	-	*681
Stage 1	-	-	-	-
Stage 2	-	-	-	-
Platoon blocked, %	-	-	-	-
Mov Cap-1 Maneuver	247	-	-	*681
Mov Cap-2 Maneuver	-	-	-	-
Stage 1	-	-	-	-
Stage 2	-	-	-	-

Approach	EB	WB	NB	SB
HCM Control Delay, s	2.1	0.6	26.4	106.7
HCM LOS			D	F

Minor Lane/Major Mvmt	NBLn1	NBLn2	EBL	EBT	EBR	WBL	WBT	WBR	SBLn1	SBLn2
Capacity (veh/h)	76	541	247	-	-	*681	-	-	30	324
HCM Lane V/C Ratio	0.233	0.092	0.485	-	-	0.116	-	-	0.938	0.228
HCM Control Delay (s)	66.2	12.3	32.6	-	-	11	-	-	\$336.4	19.4
HCM Lane LOS	F	B	D	-	-	B	-	-	F	C
HCM 95th %tile Q(veh)	0.8	0.3	2.4	-	-	0.4	-	-	3.1	0.9

Notes  
 ~: Volume exceeds capacity    \$: Delay exceeds 300s    +: Computation Not Defined    \*: All major volume in platoon

Pepper Square TIA  
HCM 6th TWSC

Phase 1 - 2026 Background + Site - PM  
3: Median Opening East of Preston Rd & Belt Line

Intersection												
Int Delay, s/veh	0.5											
Movement	EBU	EBL	EBT	EBR	WBU	WBL	WBT	WBR	NBL	NBT	NBR	SBL
Lane Configurations	↔ ↑↑↑			↔ ↑↑↑			↔ ↑↑			↔ ↑↑		
Traffic Vol, veh/h	6	6	1194	12	1	13	907	5	2	0	2	21
Future Vol, veh/h	6	6	1194	12	1	13	907	5	2	0	2	21
Conflicting Peds, #/hr	0	0	0	0	0	0	0	0	0	0	0	0
Sign Control	Free	Free	Free	Free	Free	Free	Free	Free	Stop	Stop	Stop	Stop
RT Channelized	-	-	-	None	-	-	-	None	-	-	None	-
Storage Length	-	150	-	-	-	200	-	-	-	-	-	-
Veh in Median Storage, #	-	-	0	-	-	0	-	-	-	-	1	-
Grade, %	-	-	0	-	-	0	-	-	0	-	0	-
Peak Hour Factor	93	93	93	93	93	93	93	93	93	93	93	93
Heavy Vehicles, %	2	2	2	2	2	2	2	2	2	2	2	2
Mvmt Flow	6	6	1284	13	1	14	975	5	2	0	2	23

Major/Minor	Major1	Major2	Minor1	Minor2
Conflicting Flow All	716	980	0	0
Stage 1	-	-	-	-
Stage 2	-	-	-	-
Critical Hdwy	5.64	5.34	-	-
Critical Hdwy Stg 1	-	-	-	-
Critical Hdwy Stg 2	-	-	-	-
Follow-up Hdwy	2.32	3.12	-	-
Pot Cap-1 Maneuver	*1216	893	-	-
Stage 1	-	-	-	-
Stage 2	-	-	-	-
Platoon blocked, %	1	1	-	-
Mov Cap-1 Maneuver	*1016	1016	-	-
Mov Cap-2 Maneuver	-	-	-	-
Stage 1	-	-	-	-
Stage 2	-	-	-	-

Approach	EB	WB	NB	SB
HCM Control Delay, s	0.1	0.3	29.5	13.8
HCM LOS			D	B

Minor Lane/Major Mvmt	NBLn1	EBL	EBT	EBR	WBL	WBT	WBR	SBLn1
Capacity (veh/h)	151	1016	-	-	289	-	-	455
HCM Lane V/C Ratio	0.028	0.013	-	-	0.052	-	-	0.104
HCM Control Delay (s)	29.5	8.6	-	-	18.1	-	-	13.8
HCM Lane LOS	D	A	-	-	C	-	-	B
HCM 95th %tile Q(veh)	0.1	0	-	-	0.2	-	-	0.3

Notes  
 ~: Volume exceeds capacity    \$: Delay exceeds 300s    +: Computation Not Defined    \*: All major volume in platoon



Pepper Square TIA  
HCM 6th TWSC

Phase 1 - 2026 Background + Site - PM  
5: Belt Line & Median between Berry Trail and Alexis Dr

Intersection												
Int Delay, s/veh	0.4											
Movement	EBL	EBT	EBR	WBL	WBT	WBR	NBL	NBT	NBR	SBL	SBT	SBR
Lane Configurations	↔ ↑↑↔			↔ ↑↑↔				↔			↔	
Traffic Vol, veh/h	8	1249	11	32	886	12	8	4	23	4	1	7
Future Vol, veh/h	8	1249	11	32	886	12	8	4	23	4	1	7
Conflicting Peds, #/hr	0	0	0	0	0	0	0	0	0	0	0	0
Sign Control	Free	Free	Free	Free	Free	Free	Stop	Stop	Stop	Stop	Stop	Stop
RT Channelized	-	-	None	-	-	None	-	-	None	-	-	None
Storage Length	150	-	-	150	-	-	-	-	-	-	-	-
Veh in Median Storage, #	-	0	-	-	0	-	-	1	-	-	1	-
Grade, %	-	0	-	-	0	-	-	0	-	-	0	-
Peak Hour Factor	94	94	94	94	94	94	94	94	94	94	94	94
Heavy Vehicles, %	2	2	2	2	2	2	2	2	2	2	2	2
Mvmt Flow	9	1329	12	34	943	13	9	4	24	4	1	7

Major/Minor	Major1	Major2	Minor1	Minor2
Conflicting Flow All	956	0	0	1341
Stage 1	-	-	-	-
Stage 2	-	-	-	-
Critical Hdwy	5.34	-	-	5.34
Critical Hdwy Stg 1	-	-	-	-
Critical Hdwy Stg 2	-	-	-	-
Follow-up Hdwy	3.12	-	-	3.12
Pot Cap-1 Maneuver	*904	-	-	*803
Stage 1	-	-	-	-
Stage 2	-	-	-	-
Platoon blocked, %	1	-	-	1
Mov Cap-1 Maneuver	*904	-	-	*803
Mov Cap-2 Maneuver	-	-	-	-
Stage 1	-	-	-	-
Stage 2	-	-	-	-

Approach	EB	WB	NB	SB
HCM Control Delay, s	0.1	0.3	11.8	11.3
HCM LOS			B	B

Minor Lane/Major Mvmt	NBLn1	EBL	EBT	EBR	WBL	WBT	WBR	SBLn1
Capacity (veh/h)	570	*904	-	-	*803	-	-	586
HCM Lane V/C Ratio	0.065	0.009	-	-	0.042	-	-	0.022
HCM Control Delay (s)	11.8	9	-	-	9.7	-	-	11.3
HCM Lane LOS	B	A	-	-	A	-	-	B
HCM 95th %tile Q(veh)	0.2	0	-	-	0.1	-	-	0.1

Notes  
 ~: Volume exceeds capacity    \$: Delay exceeds 300s    +: Computation Not Defined    \*: All major volume in platoon

Pepper Square TIA  
HCM 6th TWSC

Phase 1 - 2026 Background + Site - PM  
6: Alexis Drive & Belt Line

Intersection						
Int Delay, s/veh	2.7					
Movement	EBT	EBR	WBL	WBT	NBL	NBR
Lane Configurations	↑↑↔		↔ ↑↑↑		↔	↔
Traffic Vol, veh/h	1249	15	217	919	3	302
Future Vol, veh/h	1249	15	217	919	3	302
Conflicting Peds, #/hr	0	0	0	0	0	0
Sign Control	Free	Free	Free	Free	Stop	Stop
RT Channelized	-	None	-	None	-	Yield
Storage Length	-	-	150	-	0	0
Veh in Median Storage, #	0	-	-	0	1	-
Grade, %	0	-	-	0	0	-
Peak Hour Factor	95	95	95	95	95	95
Heavy Vehicles, %	2	2	2	2	2	2
Mvmt Flow	1315	16	228	967	3	318

Major/Minor	Major1	Major2	Minor1
Conflicting Flow All	0	0	1331
Stage 1	-	-	-
Stage 2	-	-	-
Critical Hdwy	-	-	5.34
Critical Hdwy Stg 1	-	-	-
Critical Hdwy Stg 2	-	-	-
Follow-up Hdwy	-	-	3.12
Pot Cap-1 Maneuver	-	-	*803
Stage 1	-	-	-
Stage 2	-	-	-
Platoon blocked, %	-	-	1
Mov Cap-1 Maneuver	-	-	*803
Mov Cap-2 Maneuver	-	-	-
Stage 1	-	-	-
Stage 2	-	-	-

Approach	EB	WB	NB
HCM Control Delay, s	0	2.2	16.1
HCM LOS			C

Minor Lane/Major Mvmt	NBLn1	NBLn2	EBT	EBR	WBL	WBT
Capacity (veh/h)	411	638	-	-	*803	-
HCM Lane V/C Ratio	0.008	0.498	-	-	0.284	-
HCM Control Delay (s)	13.8	16.1	-	-	11.3	-
HCM Lane LOS	B	C	-	-	B	-
HCM 95th %tile Q(veh)	0	2.8	-	-	1.2	-

Notes  
 ~: Volume exceeds capacity    \$: Delay exceeds 300s    +: Computation Not Defined    \*: All major volume in platoon

Pepper Square TIA  
HCM 6th TWSC

Phase 1 - 2026 Background + Site - PM  
10: Preston & Pepper Square Driveway

Intersection													
Int Delay, s/veh	4.5												
Movement	EBL	EBT	EBR	WBL	WBT	WBR	NBL	NBT	NBR	SBL	SBT	SBR	
Lane Configurations		↔			↔	↔		↔↔↔			↔↔↔		
Traffic Vol, veh/h	11	5	60	9	2	59	4	94	2248	38	6	24	1772
Future Vol, veh/h	11	5	60	9	2	59	4	94	2248	38	6	24	1772
Conflicting Peds, #/hr	0	0	0	0	0	0	0	0	0	0	0	0	0
Sign Control	Stop	Stop	Stop	Stop	Stop	Free	Free	Free	Free	Free	Free	Free	Free
RT Channelized	-	-	None	-	-	None	-	-	None	-	-	-	None
Storage Length	-	-	-	-	-	0	-	150	-	-	150	-	-
Veh in Median Storage, #	-	1	-	-	1	-	-	0	-	-	0	-	0
Grade, %	-	0	-	-	0	-	-	0	-	-	0	-	-
Peak Hour Factor	97	97	97	97	97	97	97	97	97	97	97	97	97
Heavy Vehicles, %	2	2	2	2	2	2	2	2	2	2	2	2	2
Mvmt Flow	11	5	62	9	2	61	4	97	2318	39	6	25	1827

Major/Minor	Minor2	Minor1	Major1	Major2								
Conflicting Flow All	3055	4484	949	3335	4500	1179	1385	1898	0	0	1720	2357
Stage 1	1925	1925	-	2540	2540	-	-	-	-	-	-	-
Stage 2	1130	2559	-	795	1960	-	-	-	-	-	-	-
Critical Hdwy	6.44	6.54	7.14	6.44	6.54	7.14	5.64	5.34	-	-	5.64	5.34
Critical Hdwy Stg 1	7.34	5.54	-	7.34	5.54	-	-	-	-	-	-	-
Critical Hdwy Stg 2	6.74	5.54	-	6.74	5.54	-	-	-	-	-	-	-
Follow-up Hdwy	3.82	4.02	3.92	3.82	4.02	3.92	2.32	3.12	-	-	2.32	3.12
Pot Cap-1 Maneuver	*41	*1	*509	*20	*1	157	*860	*640	-	-	173	82
Stage 1	*522	*497	-	*15	*54	-	-	-	-	-	-	-
Stage 2	*195	*53	-	*522	*497	-	-	-	-	-	-	-
Platoon blocked, %	1	1	1	1	1	1	1	1	-	-	-	-
Mov Cap-1 Maneuver	*16	*0	*509	*11	*0	157	*644	*644	-	-	86	86
Mov Cap-2 Maneuver	*55	*12	-	*12	*35	-	-	-	-	-	-	-
Stage 1	*440	*318	-	*13	*46	-	-	-	-	-	-	-
Stage 2	*96	*45	-	*289	*318	-	-	-	-	-	-	-

Approach	EB	WB	NB	SB
HCM Control Delay, s	108	118.2	0.5	1.1
HCM LOS	F	F		

Minor Lane/Major Mvmt	NBL	NBT	NBR	EBLn1	WBLn1	WBLn2	SBL	SBT	SBR
Capacity (veh/h)	*644	-	-	103	14	157	86	-	-
HCM Lane V/C Ratio	0.157	-	-	0.761	0.81	0.387	0.36	-	-
HCM Control Delay (s)	11.6	-	-	108	528.5	41.7	68.6	-	-
HCM Lane LOS	B	-	-	F	F	E	F	-	-
HCM 95th %tile Q(veh)	0.6	-	-	4.1	1.9	1.7	1.4	-	-

Notes  
 ~: Volume exceeds capacity    \$: Delay exceeds 300s    +: Computation Not Defined    \*: All major volume in platoon

Pepper Square TIA  
HCM 6th TWSC

Phase 1 - 2026 Background + Site - PM  
20: Preston & Drive 2

Intersection						
Int Delay, s/veh	0.1					
Movement	WBL	WBR	NBT	NBR	SBL	SBT
Lane Configurations		↔↔↔			↔↔↔	
Traffic Vol, veh/h	0	14	2303	8	0	1956
Future Vol, veh/h	0	14	2303	8	0	1956
Conflicting Peds, #/hr	0	0	0	0	0	0
Sign Control	Stop	Stop	Free	Free	Free	Free
RT Channelized	-	None	-	None	-	None
Storage Length	-	0	-	-	-	-
Veh in Median Storage, #	0	-	0	-	-	0
Grade, %	0	-	0	-	-	0
Peak Hour Factor	95	95	95	95	95	95
Heavy Vehicles, %	2	2	2	2	2	2
Mvmt Flow	0	15	2424	8	0	2059

Major/Minor	Minor1	Major1	Major2			
Conflicting Flow All	-	1216	0	0	-	-
Stage 1	-	-	-	-	-	-
Stage 2	-	-	-	-	-	-
Critical Hdwy	-	7.14	-	-	-	-
Critical Hdwy Stg 1	-	-	-	-	-	-
Critical Hdwy Stg 2	-	-	-	-	-	-
Follow-up Hdwy	-	3.92	-	-	-	-
Pot Cap-1 Maneuver	0	149	-	-	0	-
Stage 1	0	-	-	-	0	-
Stage 2	0	-	-	-	0	-
Platoon blocked, %	-	-	-	-	-	-
Mov Cap-1 Maneuver	-	149	-	-	-	-
Mov Cap-2 Maneuver	-	-	-	-	-	-
Stage 1	-	-	-	-	-	-
Stage 2	-	-	-	-	-	-

Approach	WB	NB	SB
HCM Control Delay, s	31.8	0	0
HCM LOS	D		

Minor Lane/Major Mvmt	NBT	NBR	WBLn1	SBT
Capacity (veh/h)	-	-	149	-
HCM Lane V/C Ratio	-	-	0.099	-
HCM Control Delay (s)	-	-	31.8	-
HCM Lane LOS	-	-	D	-
HCM 95th %tile Q(veh)	-	-	0.3	-

Pepper Square TIA  
HCM 6th TWSC

Phase 1 - 2026 Background + Site - PM  
21: Preston & Drive 1

Intersection						
Int Delay, s/veh	0					
Movement	WBL	WBR	NBT	NBR	SBL	SBT
Lane Configurations		↑↑↑	↑↑↑			↑↑↑
Traffic Vol, veh/h	0	2	2385	2	0	1794
Future Vol, veh/h	0	2	2385	2	0	1794
Conflicting Peds, #/hr	0	0	0	0	0	0
Sign Control	Stop	Stop	Free	Free	Free	Free
RT Channelized	-	None	-	None	-	None
Storage Length	-	0	-	-	-	-
Veh in Median Storage, #	0	-	0	-	-	0
Grade, %	0	-	0	-	-	0
Peak Hour Factor	95	95	95	95	95	95
Heavy Vehicles, %	2	2	2	2	2	2
Mvmt Flow	0	2	2511	2	0	1888

Major/Minor	Minor1	Major1	Major2		
Conflicting Flow All	-	1257	0	0	-
Stage 1	-	-	-	-	-
Stage 2	-	-	-	-	-
Critical Hdwy	-	7.14	-	-	-
Critical Hdwy Stg 1	-	-	-	-	-
Critical Hdwy Stg 2	-	-	-	-	-
Follow-up Hdwy	-	3.92	-	-	-
Pot Cap-1 Maneuver	0	139	-	-	0
Stage 1	0	-	-	-	0
Stage 2	0	-	-	-	0
Platoon blocked, %	-	-	-	-	-
Mov Cap-1 Maneuver	-	139	-	-	-
Mov Cap-2 Maneuver	-	-	-	-	-
Stage 1	-	-	-	-	-
Stage 2	-	-	-	-	-

Approach	WB	NB	SB
HCM Control Delay, s	31.3	0	0
HCM LOS	D		

Minor Lane/Major Mvmt	NBT	NBRWBLn1	SBT
Capacity (veh/h)	-	-	139
HCM Lane V/C Ratio	-	-	0.015
HCM Control Delay (s)	-	-	31.3
HCM Lane LOS	-	-	D
HCM 95th %tile Q(veh)	-	-	0

Pepper Square TIA  
HCM 6th TWSC

Phase 1 - 2026 Background + Site - PM  
22: Drive 6 & Belt Line

Intersection						
Int Delay, s/veh	0.1					
Movement	EBT	EBR	WBL	WBT	NBL	NBR
Lane Configurations	↑↑↑			↑↑↑		↑
Traffic Vol, veh/h	1240	8	0	921	0	8
Future Vol, veh/h	1240	8	0	921	0	8
Conflicting Peds, #/hr	0	0	0	0	0	0
Sign Control	Free	Free	Free	Free	Stop	Stop
RT Channelized	-	None	-	None	-	None
Storage Length	-	-	-	-	-	0
Veh in Median Storage, #	0	-	-	0	0	-
Grade, %	0	-	-	0	0	-
Peak Hour Factor	93	93	93	93	93	93
Heavy Vehicles, %	2	2	2	2	2	2
Mvmt Flow	1333	9	0	990	0	9

Major/Minor	Major1	Major2	Minor1		
Conflicting Flow All	0	0	-	-	671
Stage 1	-	-	-	-	-
Stage 2	-	-	-	-	-
Critical Hdwy	-	-	-	-	7.14
Critical Hdwy Stg 1	-	-	-	-	-
Critical Hdwy Stg 2	-	-	-	-	-
Follow-up Hdwy	-	-	-	-	3.92
Pot Cap-1 Maneuver	-	-	0	-	0
Stage 1	-	-	0	-	0
Stage 2	-	-	0	-	0
Platoon blocked, %	-	-	-	-	-
Mov Cap-1 Maneuver	-	-	-	-	342
Mov Cap-2 Maneuver	-	-	-	-	-
Stage 1	-	-	-	-	-
Stage 2	-	-	-	-	-

Approach	EB	WB	NB
HCM Control Delay, s	0	0	15.8
HCM LOS			C

Minor Lane/Major Mvmt	NBLn1	EBT	EBR	WBT
Capacity (veh/h)	342	-	-	-
HCM Lane V/C Ratio	0.025	-	-	-
HCM Control Delay (s)	15.8	-	-	-
HCM Lane LOS	C	-	-	-
HCM 95th %tile Q(veh)	0.1	-	-	-

Pepper Square TIA  
HCM 6th TWSC

Phase 1 - 2026 Background + Site - PM  
24: Drive 5 & Belt Line

Intersection						
Int Delay, s/veh	0					
Movement	EBT	EBR	WBL	WBT	NBL	NBR
Lane Configurations	↑↑↑			↑↑↑		↑
Traffic Vol, veh/h	1222	0	0	877	0	5
Future Vol, veh/h	1222	0	0	877	0	5
Conflicting Peds, #/hr	0	0	0	0	0	0
Sign Control	Free	Free	Free	Free	Stop	Stop
RT Channelized	-	None	-	None	-	None
Storage Length	-	-	-	-	-	0
Veh in Median Storage, #	0	-	-	0	0	-
Grade, %	0	-	-	0	0	-
Peak Hour Factor	93	93	93	93	93	93
Heavy Vehicles, %	2	2	2	2	2	2
Mvmt Flow	1314	0	0	943	0	5

Major/Minor	Major1	Major2	Minor1
Conflicting Flow All	0	0	- 657
Stage 1	-	-	-
Stage 2	-	-	-
Critical Hdwy	-	-	- 7.14
Critical Hdwy Stg 1	-	-	-
Critical Hdwy Stg 2	-	-	-
Follow-up Hdwy	-	-	- 3.92
Pot Cap-1 Maneuver	-	0	- 0 349
Stage 1	-	0	- 0
Stage 2	-	0	- 0
Platoon blocked, %	-	-	-
Mov Cap-1 Maneuver	-	-	- 349
Mov Cap-2 Maneuver	-	-	-
Stage 1	-	-	-
Stage 2	-	-	-

Approach	EB	WB	NB
HCM Control Delay, s	0	0	15.5
HCM LOS			C

Minor Lane/Major Mvmt	NBLn1	EBT	EBR	WBT
Capacity (veh/h)	349	-	-	-
HCM Lane V/C Ratio	0.015	-	-	-
HCM Control Delay (s)	15.5	-	-	-
HCM Lane LOS	C	-	-	-
HCM 95th %tile Q(veh)	0	-	-	-

Pepper Square TIA  
HCM 6th TWSC

Phase 1 - 2026 Background + Site - PM  
25: Preston & Drive 4

Intersection						
Int Delay, s/veh	0.1					
Movement	WBL	WBR	NBT	NBR	SBL	SBT
Lane Configurations		↑↑↑	↑↑↑			↑↑↑
Traffic Vol, veh/h	0	10	2389	9	0	1956
Future Vol, veh/h	0	10	2389	9	0	1956
Conflicting Peds, #/hr	0	0	0	0	0	0
Sign Control	Stop	Stop	Free	Free	Free	Free
RT Channelized	-	None	-	None	-	None
Storage Length	-	0	-	-	-	-
Veh in Median Storage, #	0	-	0	-	0	0
Grade, %	0	-	0	-	0	0
Peak Hour Factor	95	95	95	95	95	95
Heavy Vehicles, %	2	2	2	2	2	2
Mvmt Flow	0	11	2515	9	0	2059

Major/Minor	Minor1	Major1	Major2
Conflicting Flow All	- 1262	0	0 -
Stage 1	-	-	-
Stage 2	-	-	-
Critical Hdwy	- 7.14	-	-
Critical Hdwy Stg 1	-	-	-
Critical Hdwy Stg 2	-	-	-
Follow-up Hdwy	- 3.92	-	-
Pot Cap-1 Maneuver	0 138	-	- 0
Stage 1	0	-	- 0
Stage 2	0	-	- 0
Platoon blocked, %	-	-	-
Mov Cap-1 Maneuver	- 138	-	-
Mov Cap-2 Maneuver	-	-	-
Stage 1	-	-	-
Stage 2	-	-	-

Approach	WB	NB	SB
HCM Control Delay, s	33.2	0	0
HCM LOS	D		

Minor Lane/Major Mvmt	NBT	NBRWBLn1	SBT
Capacity (veh/h)	-	- 138	-
HCM Lane V/C Ratio	-	- 0.076	-
HCM Control Delay (s)	-	- 33.2	-
HCM Lane LOS	-	- D	-
HCM 95th %tile Q(veh)	-	- 0.2	-

Intersection						
Int Delay, s/veh	0.3					
Movement	WBL	WBR	NBT	NBR	SBL	SBT
Lane Configurations			↑ ↑ ↑			↑ ↑ ↑
Traffic Vol, veh/h	0	30	2389	17	0	1956
Future Vol, veh/h	0	30	2389	17	0	1956
Conflicting Peds, #/hr	0	0	0	0	0	0
Sign Control	Stop	Stop	Free	Free	Free	Free
RT Channelized	-	None	-	None	-	None
Storage Length	-	0	-	-	-	-
Veh in Median Storage, #	0	-	0	-	-	0
Grade, %	0	-	0	-	-	0
Peak Hour Factor	95	95	95	95	95	95
Heavy Vehicles, %	2	2	2	2	2	2
Mvmt Flow	0	32	2515	18	0	2059

Major/Minor	Minor1	Major1	Major2		
Conflicting Flow All	-	1267	0	0	-
Stage 1	-	-	-	-	-
Stage 2	-	-	-	-	-
Critical Hdwy	-	7.14	-	-	-
Critical Hdwy Stg 1	-	-	-	-	-
Critical Hdwy Stg 2	-	-	-	-	-
Follow-up Hdwy	-	3.92	-	-	-
Pot Cap-1 Maneuver	0	137	-	-	0
Stage 1	0	-	-	-	0
Stage 2	0	-	-	-	0
Platoon blocked, %	-	-	-	-	-
Mov Cap-1 Maneuver	-	137	-	-	-
Mov Cap-2 Maneuver	-	-	-	-	-
Stage 1	-	-	-	-	-
Stage 2	-	-	-	-	-

Approach	WB	NB	SB
HCM Control Delay, s	39	0	0
HCM LOS	E		

Minor Lane/Major Mvmt	NBT	NBRWBLn1	SBT
Capacity (veh/h)	-	-	137
HCM Lane V/C Ratio	-	-	0.231
HCM Control Delay (s)	-	-	39
HCM Lane LOS	-	-	E
HCM 95th %tile Q(veh)	-	-	0.8

**Synchro™ Output - 2028 Background Traffic**

Pepper Square TIA  
Lanes, Volumes, Timings

Phase 1 & P - 2028 Background - AM  
4: Berry Trail & Belt Line

Lane Group	EBL	EBT	EBR	WBL	WBT	WBR	NBL	NBT	NBR	SBL	SBT	SBR
Lane Configurations	←	←←	←	←	←←	←	←	←	←	←	←	←
Traffic Volume (vph)	13	509	4	3	1027	22	1	1	0	35	7	63
Future Volume (vph)	13	509	4	3	1027	22	1	1	0	35	7	63
Ideal Flow (vphpl)	1900	1900	1900	1900	1900	1900	1900	1900	1900	1900	1900	1900
Storage Length (ft)	150	0	150	0	0	0	0	0	0	0	0	0
Storage Lanes	1	0	1	0	1	0	1	0	1	0	1	0
Taper Length (ft)	25		25		25		25		25		25	
Lane Util. Factor	1.00	0.91	0.91	1.00	0.91	0.91	1.00	1.00	1.00	1.00	1.00	1.00
Frt		0.999		0.997						0.865		
Fit Protected	0.950		0.950		0.950		0.950		0.950		0.950	
Satd. Flow (prot)	1770	5080	0	1770	5070	0	1770	1863	0	1770	1611	0
Fit Permitted	0.206		0.413		0.575							
Satd. Flow (perm)	384	5080	0	769	5070	0	1071	1863	0	1863	1611	0
Right Turn on Red		Yes		Yes		Yes		Yes		Yes		Yes
Satd. Flow (RTOR)		1		3		74		74				74
Link Speed (mph)	42		42		30		30		30		30	
Link Distance (ft)	234		493		277		236		236		236	
Travel Time (s)	3.8		8.0		6.3		5.4		5.4		5.4	
Peak Hour Factor	0.85	0.85	0.85	0.85	0.85	0.85	0.85	0.85	0.85	0.85	0.85	0.85
Adj. Flow (vph)	15	599	5	4	1208	26	1	1	0	41	8	74
Shared Lane Traffic (%)												
Lane Group Flow (vph)	15	604	0	4	1234	0	1	1	0	41	82	0
Enter Blocked Intersection	No	No	No	No	No	No	No	No	No	No	No	No
Lane Alignment	Left	Left	Right	Left	Left	Right	Left	Left	Right	Left	Left	Right
Median Width(ft)	12		12		12		12		12		12	
Link Offset(ft)	0		0		0		0		0		0	
Crosswalk Width(ft)	16		16		16		16		16		16	
Two way Left Turn Lane												
Headway Factor	1.00	1.00	1.00	1.00	1.00	1.00	1.00	1.00	1.00	1.00	1.00	1.00
Turning Speed (mph)	15		9	15		9	15		9	15		9
Number of Detectors	1	2		1	2		1	2		1	2	
Detector Template	Left	Thru		Left	Thru		Left	Thru		Left	Thru	
Leading Detector (ft)	20	100		20	100		20	100		20	100	
Trailing Detector (ft)	0	0		0	0		0	0		0	0	
Detector 1 Position(ft)	0	0		0	0		0	0		0	0	
Detector 1 Size(ft)	20	6		20	6		20	6		20	6	
Detector 1 Type	CI+Ex	CI+Ex		CI+Ex	CI+Ex		CI+Ex	CI+Ex		CI+Ex	CI+Ex	
Detector 1 Channel												
Detector 1 Extend (s)	0.0	0.0		0.0	0.0		0.0	0.0		0.0	0.0	
Detector 1 Queue (s)	0.0	0.0		0.0	0.0		0.0	0.0		0.0	0.0	
Detector 1 Delay (s)	0.0	0.0		0.0	0.0		0.0	0.0		0.0	0.0	
Detector 2 Position(ft)	94		94		94		94		94		94	
Detector 2 Size(ft)	6		6		6		6		6		6	
Detector 2 Type	CI+Ex		CI+Ex		CI+Ex		CI+Ex		CI+Ex		CI+Ex	
Detector 2 Channel												
Detector 2 Extend (s)	0.0		0.0		0.0		0.0		0.0		0.0	
Turn Type	D,P+P	NA		D,P+P	NA		D,P+P	NA		D,P+P	NA	
Protected Phases	3	8		7	4		1	6		5	2	
Permitted Phases	4		8		2		6		6			

Pepper Square TIA  
Lanes, Volumes, Timings

Phase 1 & P - 2028 Background - AM  
4: Berry Trail & Belt Line

Lane Group	EBL	EBT	EBR	WBL	WBT	WBR	NBL	NBT	NBR	SBL	SBT	SBR
Detector Phase	3	8		7	4		1	6		5	2	
Switch Phase												
Minimum Initial (s)	4.0	4.0		4.0	4.0		4.0	4.0		4.0	4.0	
Minimum Split (s)	10.0	24.0		10.0	24.0		10.0	31.0		10.0	31.0	
Total Split (s)	15.0	99.0		15.0	99.0		15.0	31.0		15.0	31.0	
Total Split (%)	9.4%	61.9%		9.4%	61.9%		9.4%	19.4%		9.4%	19.4%	
Maximum Green (s)	9.0	93.0		9.0	93.0		9.0	25.0		9.0	25.0	
Yellow Time (s)	4.0	4.0		4.0	4.0		4.0	4.0		4.0	4.0	
All-Red Time (s)	2.0	2.0		2.0	2.0		2.0	2.0		2.0	2.0	
Lost Time Adjust (s)	0.0	0.0		0.0	0.0		0.0	0.0		0.0	0.0	
Total Lost Time (s)	6.0	6.0		6.0	6.0		6.0	6.0		6.0	6.0	
Lead/Lag	Lead	Lag		Lead	Lag		Lead	Lag		Lead	Lag	
Lead-Lag Optimize?	Yes	Yes		Yes	Yes		Yes	Yes		Yes	Yes	
Vehicle Extension (s)	1.0	1.0		1.0	1.0		1.0	1.0		1.0	1.0	
Recall Mode	None	C-Max		None	C-Max		None	None		None	None	
Walk Time (s)		4.0			4.0			4.0			4.0	
Flash Dont Walk (s)		14.0			14.0			21.0			21.0	
Pedestrian Calls (/hr)		0			0			0			0	
Act Effect Green (s)	136.5	136.9		137.7	134.9		7.9	4.2		7.9	7.1	
Actuated g/C Ratio	0.85	0.86		0.86	0.84		0.05	0.03		0.05	0.04	
v/c Ratio	0.04	0.14		0.01	0.29		0.01	0.02		0.47	0.58	
Control Delay	3.8	3.8		0.7	1.0		66.0	76.0		87.2	34.3	
Queue Delay	0.0	0.0		0.0	0.0		0.0	0.0		0.0	0.0	
Total Delay	3.8	3.8		0.7	1.0		66.0	76.0		87.2	34.3	
LOS	A	A		A	A		E	E		F	C	
Approach Delay		3.8			1.0			71.0			51.9	
Approach LOS		A			A			E			D	
Queue Length 50th (ft)	3	43		0	16		1	1		43	8	
Queue Length 95th (ft)	m7	60		m0	40		8	8		75	58	
Internal Link Dist (ft)		154			413			197			156	
Turn Bay Length (ft)	150			150								
Base Capacity (vph)	410	4346		723	4273		112	291		111	314	
Starvation Cap Reductn	0	0		0	0		0	0		0	0	
Spillback Cap Reductn	0	0		0	0		0	0		0	0	
Storage Cap Reductn	0	0		0	0		0	0		0	0	
Reduced v/c Ratio	0.04	0.14		0.01	0.29		0.01	0.00		0.37	0.26	
<b>Intersection Summary</b>												
Area Type: Other												
Cycle Length: 160												
Actuated Cycle Length: 160												
Offset: 11 (7%), Referenced to phase 4:EBWB and 8:EBWB, Start of Yellow												
Natural Cycle: 75												
Control Type: Actuated-Coordinated												
Maximum v/c Ratio: 0.58												
Intersection Signal Delay: 5.1 Intersection LOS: A												
Intersection Capacity Utilization 38.9% ICU Level of Service A												
Analysis Period (min) 15												
m Volume for 95th percentile queue is metered by upstream signal.												

Pepper Square TIA  
Lanes, Volumes, Timings

Phase 1 & P - 2028 Background - AM  
4: Berry Trail & Belt Line

Splits and Phases: 4: Berry Trail & Belt Line

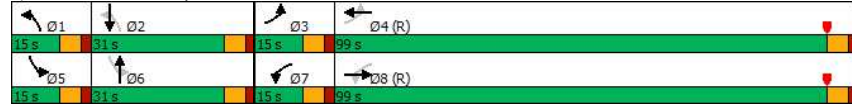

Pepper Square TIA  
Lanes, Volumes, Timings

Phase 1 & P - 2028 Background - AM  
1335: Meadow Creek & Belt Line

Lane Group	EBL	EBT	EBR	WBL	WBT	WBR	NBL	NBT	NBR	SBL	SBT	SBR
Lane Configurations												
Traffic Volume (vph)	29	677	16	3	1080	18	21	3	6	8	9	82
Future Volume (vph)	29	677	16	3	1080	18	21	3	6	8	9	82
Ideal Flow (vphpl)	1900	1900	1900	1900	1900	1900	1900	1900	1900	1900	1900	1900
Storage Length (ft)	150		0	150		0	0		0	0		0
Storage Lanes	1		0	1		0	0		0	0		0
Taper Length (ft)	25			25			25			25		
Lane Util. Factor	1.00	0.91	0.91	1.00	0.91	0.91	1.00	1.00	1.00	1.00	1.00	1.00
Frt		0.997			0.998			0.975				0.889
Fit Protected	0.950			0.950				0.965				0.996
Satd. Flow (prot)	1770	5070	0	1770	5075	0	0	1753	0	0	0	1649
Fit Permitted	0.212			0.349				0.705				0.978
Satd. Flow (perm)	395	5070	0	650	5075	0	0	1280	0	0	0	1620
Right Turn on Red			Yes			Yes			Yes			Yes
Satd. Flow (RTOR)		5			3			6				88
Link Speed (mph)	42			42			30					30
Link Distance (ft)		1673			2404		392					423
Travel Time (s)		27.2			39.0		8.9					9.6
Peak Hour Factor	0.93	0.93	0.93	0.93	0.93	0.93	0.93	0.93	0.93	0.93	0.93	0.93
Adj. Flow (vph)	31	728	17	3	1161	19	23	3	6	9	10	88
Shared Lane Traffic (%)												
Lane Group Flow (vph)	31	745	0	3	1180	0	0	32	0	0	0	107
Enter Blocked Intersection	No	No	No	No	No	No	No	No	No	No	No	No
Lane Alignment	Left	Left	Right	Left	Left	Right	Left	Left	Right	Left	Left	Right
Median Width(ft)	12			12			0					0
Link Offset(ft)	0			0			0					0
Crosswalk Width(ft)	16			16			16					16
Two way Left Turn Lane												
Headway Factor	1.00	1.00	1.00	1.00	1.00	1.00	1.00	1.00	1.00	1.00	1.00	1.00
Turning Speed (mph)	15		9	15		9	15		9	15		9
Number of Detectors	1	1		1	1		1	1		1	1	
Detector Template												
Leading Detector (ft)	50	50		50	50		50	50		50	50	
Trailing Detector (ft)	0	0		0	0		0	0		0	0	
Detector 1 Position(ft)	0	0		0	0		0	0		0	0	
Detector 1 Size(ft)	50	50		50	50		50	50		50	50	
Detector 1 Type	CI+Ex	CI+Ex		CI+Ex	CI+Ex		CI+Ex	CI+Ex		CI+Ex	CI+Ex	
Detector 1 Channel												
Detector 1 Extend (s)	0.0	0.0		0.0	0.0		0.0	0.0		0.0	0.0	
Detector 1 Queue (s)	0.0	0.0		0.0	0.0		0.0	0.0		0.0	0.0	
Detector 1 Delay (s)	0.0	0.0		0.0	0.0		0.0	0.0		0.0	0.0	
Turn Type	Perm	NA		Perm	NA		Perm	NA		Perm	NA	
Protected Phases		6 14			2 10			4 12			4 12	
Permitted Phases	6 14			2 10		4 12			4 12			
Detector Phase	6 14	6 14		2 10	2 10		4 12	4 12		4 12	4 12	
Switch Phase												
Minimum Initial (s)												
Minimum Split (s)												
Total Split (s)												



Pepper Square TIA  
Lanes, Volumes, Timings

Phase 1 & P - 2028 Background - AM  
1335: Meadow Creek & Belt Line

Lane Group	Ø2	Ø4	Ø6	Ø10	Ø12	Ø14
Lane Configurations						
Traffic Volume (vph)						
Future Volume (vph)						
Ideal Flow (vphpl)						
Storage Length (ft)						
Storage Lanes						
Taper Length (ft)						
Lane Util. Factor						
Frt						
Fit Protected						
Satd. Flow (prot)						
Fit Permitted						
Satd. Flow (perm)						
Right Turn on Red						
Satd. Flow (RTOR)						
Link Speed (mph)						
Link Distance (ft)						
Travel Time (s)						
Peak Hour Factor						
Adj. Flow (vph)						
Shared Lane Traffic (%)						
Lane Group Flow (vph)						
Enter Blocked Intersection						
Lane Alignment						
Median Width(ft)						
Link Offset(ft)						
Crosswalk Width(ft)						
Two way Left Turn Lane						
Headway Factor						
Turning Speed (mph)						
Number of Detectors						
Detector Template						
Leading Detector (ft)						
Trailing Detector (ft)						
Detector 1 Position(ft)						
Detector 1 Size(ft)						
Detector 1 Type						
Detector 1 Channel						
Detector 1 Extend (s)						
Detector 1 Queue (s)						
Detector 1 Delay (s)						
Turn Type						
Protected Phases	2	4	6	10	12	14
Permitted Phases						
Detector Phase						
Switch Phase						
Minimum Initial (s)	12.0	6.0	12.0	12.0	12.0	6.0
Minimum Split (s)	17.0	23.5	17.0	20.0	23.0	20.0
Total Split (s)	96.0	22.0	96.0	22.0	20.0	22.0

Pepper Square TIA  
Lanes, Volumes, Timings

Phase 1 & P - 2028 Background - AM  
1335: Meadow Creek & Belt Line

Lane Group	EBL	EBT	EBR	WBL	WBT	WBR	NBL	NBT	NBR	SBL	SBT	SBR
Total Split (%)												
Maximum Green (s)												
Yellow Time (s)												
All-Red Time (s)												
Lost Time Adjust (s)												
Total Lost Time (s)												
Lead/Lag												
Lead-Lag Optimize?												
Vehicle Extension (s)												
Recall Mode												
Walk Time (s)												
Flash Dont Walk (s)												
Pedestrian Calls (#/hr)												
Act Effect Green (s)	122.1	122.1		122.1	122.1			21.9				21.9
Actuated g/C Ratio	0.76	0.76		0.76	0.76			0.14				0.14
v/c Ratio	0.10	0.19		0.01	0.30			0.18				0.36
Control Delay	2.0	1.3		0.3	0.3			39.9				15.4
Queue Delay	0.0	0.0		0.0	0.0			0.0				0.0
Total Delay	2.0	1.3		0.3	0.3			39.9				15.4
LOS	A	A		A	A			D				B
Approach Delay		1.4			0.3			39.9				15.4
Approach LOS		A			A			D				B
Queue Length 50th (ft)	1	12		0	5			21				15
Queue Length 95th (ft)	3	14		m0	m5			48				63
Internal Link Dist (ft)		1593			2324			312				343
Turn Bay Length (ft)	150			150								
Base Capacity (vph)	312	4015		514	4019			276				413
Starvation Cap Reductn	0	0		0	0			0				0
Spillback Cap Reductn	0	0		0	0			0				0
Storage Cap Reductn	0	0		0	0			0				0
Reduced v/c Ratio	0.10	0.19		0.01	0.29			0.12				0.26

**Intersection Summary**  
 Area Type: Other  
 Cycle Length: 160  
 Actuated Cycle Length: 160  
 Offset: 82 (51%), Referenced to phase 2:WBTL and 6:EBTL, Start of Yellow  
 Natural Cycle: 85  
 Control Type: Actuated-Coordinated  
 Maximum v/c Ratio: 0.36  
 Intersection Signal Delay: 2.1 Intersection LOS: A  
 Intersection Capacity Utilization 39.1% ICU Level of Service A  
 Analysis Period (min) 15  
 m Volume for 95th percentile queue is metered by upstream signal.

Splits and Phases: 1335: Meadow Creek & Belt Line

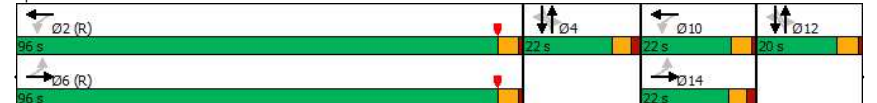

Pepper Square TIA  
Lanes, Volumes, Timings

Phase 1 & P - 2028 Background - AM  
1335: Meadow Creek & Belt Line

Lane Group	Ø2	Ø4	Ø6	Ø10	Ø12	Ø14
Total Split (%)	60%	14%	60%	14%	13%	14%
Maximum Green (s)	91.0	16.5	91.0	17.0	15.0	16.5
Yellow Time (s)	4.0	3.7	4.0	4.0	4.0	3.7
All-Red Time (s)	1.0	1.8	1.0	1.0	1.0	1.8
Lost Time Adjust (s)						
Total Lost Time (s)						
Lead/Lag						
Lead-Lag Optimize?						
Vehicle Extension (s)	2.0	1.8	2.0	2.0	1.8	2.0
Recall Mode	C-Max	None	C-Min	None	None	None
Walk Time (s)	4.0	4.0	4.0	4.0	4.0	4.0
Flash Dont Walk (s)	8.0	14.0	8.0	8.0	14.0	8.0
Pedestrian Calls (#/hr)	0	0	0	0	0	0
Act Effect Green (s)						
Actuated g/C Ratio						
v/c Ratio						
Control Delay						
Queue Delay						
Total Delay						
LOS						
Approach Delay						
Approach LOS						
Queue Length 50th (ft)						
Queue Length 95th (ft)						
Internal Link Dist (ft)						
Turn Bay Length (ft)						
Base Capacity (vph)						
Starvation Cap Reductn						
Spillback Cap Reductn						
Storage Cap Reductn						
Reduced v/c Ratio						
Intersection Summary						

Pepper Square TIA  
Lanes, Volumes, Timings

Phase 1 & P - 2028 Background - AM  
1365: Preston & Arapah

Lane Group	EBU	EBL	EBT	EBR	WBL	WBT	WBR	NBU	NBL	NBT	NBR	SBU
Lane Configurations		↔↔	↕↕		↔↔	↕↕			↔↔	↕↕		
Traffic Volume (vph)	3	138	271	147	120	741	170	1	128	1710	96	4
Future Volume (vph)	3	138	271	147	120	741	170	1	128	1710	96	4
Ideal Flow (vphpl)	1900	1900	1900	1900	1900	1900	1900	1900	1900	1900	1900	1900
Storage Length (ft)		150		0	150		0		300		0	
Storage Lanes		2		0	2		0		2		0	
Taper Length (ft)		25			25				25			
Lane Util. Factor	0.91	0.97	0.91	0.91	0.97	0.91	0.91	0.91	0.97	0.91	0.91	0.91
Frt			0.947			0.972				0.992		
Fit Protected		0.950			0.950				0.950			
Satd. Flow (prot)	0	3433	4816	0	3433	4943	0	0	3433	5045	0	0
Fit Permitted		0.950			0.950				0.950			
Satd. Flow (perm)	0	3433	4816	0	3433	4943	0	0	3433	5045	0	0
Right Turn on Red			Yes			Yes				Yes		
Satd. Flow (RTOR)			82			32				7		
Link Speed (mph)			42			42				42		
Link Distance (ft)			1672			1942				3054		
Travel Time (s)			27.1			31.5				49.6		
Peak Hour Factor	0.95	0.95	0.95	0.95	0.95	0.95	0.95	0.95	0.95	0.95	0.95	0.95
Adj. Flow (vph)	3	145	285	155	126	780	179	1	135	1800	101	4
Shared Lane Traffic (%)												
Lane Group Flow (vph)	0	148	440	0	126	959	0	0	136	1901	0	0
Enter Blocked Intersection	No	No	No	No	No	No	No	No	No	No	No	No
Lane Alignment	R NA	Left	Left	Right	Left	Left	Right	R NA	Left	Left	Right	R NA
Median Width(ft)			24			24				24		
Link Offset(ft)			0			0				0		
Crosswalk Width(ft)			16			16				16		
Two way Left Turn Lane												
Headway Factor	1.00	1.00	1.00	1.00	1.00	1.00	1.00	1.00	1.00	1.00	1.00	1.00
Turning Speed (mph)	9	15		9	15		9	9	15		9	9
Number of Detectors	1	1	1		1	1		1	1	1		1
Detector Template												
Leading Detector (ft)	50	50	50		50	50		50	50	50		50
Trailing Detector (ft)	0	0	0		0	0		0	0	0		0
Detector 1 Position(ft)	0	0	0		0	0		0	0	0		0
Detector 1 Size(ft)	50	50	50		50	50		50	50	50		50
Detector 1 Type	CI+Ex	CI+Ex	CI+Ex		CI+Ex	CI+Ex		CI+Ex	CI+Ex	CI+Ex		CI+Ex
Detector 1 Channel												
Detector 1 Extend (s)	0.0	0.0	0.0		0.0	0.0		0.0	0.0	0.0		0.0
Detector 1 Queue (s)	0.0	0.0	0.0		0.0	0.0		0.0	0.0	0.0		0.0
Detector 1 Delay (s)	0.0	0.0	0.0		0.0	0.0		0.0	0.0	0.0		0.0
Turn Type	Prot	Prot	NA		Prot	NA		Prot	Prot	NA		Prot
Protected Phases	3	3	8		7	4		1	1	6		5
Permitted Phases												
Detector Phase	3	3	8		7	4		1	1	6		5
Switch Phase												
Minimum Initial (s)	3.0	3.0	18.0		3.0	18.0		3.0	3.0	18.0		3.0
Minimum Split (s)	10.0	10.0	36.7		21.0	36.3		10.0	10.0	35.7		10.0
Total Split (s)	13.0	13.0	44.0		18.0	49.0		14.0	14.0	78.0		20.0

Pepper Square TIA  
Lanes, Volumes, Timings

Phase 1 & P - 2028 Background - AM  
1365: Preston & Arapaho

Lane Group	SBL	SBT	SBR
Lane Configurations	↑↑	↑↑↑	
Traffic Volume (vph)	101	1840	219
Future Volume (vph)	101	1840	219
Ideal Flow (vphpl)	1900	1900	1900
Storage Length (ft)	250		0
Storage Lanes	2		0
Taper Length (ft)	25		
Lane Util. Factor	0.97	0.91	0.91
Frt		0.984	
Fit Protected	0.950		
Satd. Flow (prot)	3433	5004	0
Fit Permitted	0.950		
Satd. Flow (perm)	3433	5004	0
Right Turn on Red			Yes
Satd. Flow (RTOR)		18	
Link Speed (mph)		48	
Link Distance (ft)		5087	
Travel Time (s)		72.3	
Peak Hour Factor	0.95	0.95	0.95
Adj. Flow (vph)	106	1937	231
Shared Lane Traffic (%)			
Lane Group Flow (vph)	110	2168	0
Enter Blocked Intersection	No	No	No
Lane Alignment	Left	Left	Right
Median Width(ft)		24	
Link Offset(ft)		0	
Crosswalk Width(ft)		16	
Two way Left Turn Lane			
Headway Factor	1.00	1.00	1.00
Turning Speed (mph)	15		9
Number of Detectors	1	1	
Detector Template			
Leading Detector (ft)	50	50	
Trailing Detector (ft)	0	0	
Detector 1 Position(ft)	0	0	
Detector 1 Size(ft)	50	50	
Detector 1 Type	CI+Ex	CI+Ex	
Detector 1 Channel			
Detector 1 Extend (s)	0.0	0.0	
Detector 1 Queue (s)	0.0	0.0	
Detector 1 Delay (s)	0.0	0.0	
Turn Type	Prot	NA	
Protected Phases	5	2	
Permitted Phases			
Detector Phase	5	2	
Switch Phase			
Minimum Initial (s)	3.0	18.0	
Minimum Split (s)	10.0	37.7	
Total Split (s)	20.0	84.0	

09/26/2022 4:33 pm  
Kimley-Horn

Synchro 11 Report  
Page 9

Pepper Square TIA  
Lanes, Volumes, Timings

Phase 1 & P - 2028 Background - AM  
1365: Preston & Arapaho

Lane Group	EBU	EBL	EBT	EBR	WBL	WBT	WBR	NBU	NBL	NBT	NBR	SBU
Total Split (%)	8.1%	8.1%	27.5%		11.3%	30.6%		8.8%	8.8%	48.8%		12.5%
Maximum Green (s)	7.5	7.5	38.7		12.5	43.7		8.5	8.5	72.3		14.5
Yellow Time (s)	3.0	3.0	4.3		3.0	4.3		3.0	3.0	4.7		3.0
All-Red Time (s)	2.5	2.5	1.0		2.5	1.0		2.5	2.5	1.0		2.5
Lost Time Adjust (s)		-1.0	-1.4		-1.0	-1.0			-1.0	-1.7		
Total Lost Time (s)		4.5	3.9		4.5	4.3			4.5	4.0		
Lead/Lag	Lead	Lead	Lag		Lead	Lag		Lead	Lead	Lead		Lag
Lead-Lag Optimize?	Yes	Yes	Yes		Yes	Yes		Yes	Yes	Yes		Yes
Vehicle Extension (s)	0.8	0.8	2.5		0.8	1.8		1.5	1.5	1.7		1.5
Recall Mode	None	None	Max		None	None		None	None	Max		None
Walk Time (s)			4.0			4.0				4.0		
Flash Dont Walk (s)			27.0			27.0				26.0		
Pedestrian Calls (#/hr)			0			0				0		
Act Effect Green (s)		8.4	43.5		10.1	44.8			9.2	74.0		
Actuated g/C Ratio		0.05	0.27		0.06	0.28			0.06	0.46		
v/c Ratio		0.82	0.32		0.58	0.68			0.69	0.81		
Control Delay		104.3	37.8		78.7	62.3			86.9	24.7		
Queue Delay		0.0	0.0		0.0	0.0			0.0	0.0		
Total Delay		104.3	37.8		78.7	62.3			86.9	24.7		
LOS		F	D		E	E			F	C		
Approach Delay			54.5			64.2				28.9		
Approach LOS			D			E				C		
Queue Length 50th (ft)		80	109		67	359			65	684		
Queue Length 95th (ft)		#142	144		103	423			m94	751		
Internal Link Dist (ft)			1592			1862				2974		
Turn Bay Length (ft)		150			150				300			
Base Capacity (vph)		182	1369		289	1406			203	2337		
Starvation Cap Reductn		0	0		0	0			0	0		
Spillback Cap Reductn		0	0		0	0			0	0		
Storage Cap Reductn		0	0		0	0			0	0		
Reduced v/c Ratio		0.81	0.32		0.44	0.68			0.67	0.81		

Intersection Summary

Area Type: Other  
 Cycle Length: 160  
 Actuated Cycle Length: 160  
 Offset: 11 (7%), Referenced to phase 2:SBT, Start of Yellow  
 Natural Cycle: 120  
 Control Type: Actuated-Coordinated  
 Maximum v/c Ratio: 0.86  
 Intersection Signal Delay: 44.9  
 Intersection LOS: D  
 Intersection Capacity Utilization 80.7%  
 ICU Level of Service D  
 Analysis Period (min) 15  
 # 95th percentile volume exceeds capacity, queue may be longer.  
 Queue shown is maximum after two cycles.  
 m Volume for 95th percentile queue is metered by upstream signal.

Splits and Phases: 1365: Preston & Arapaho

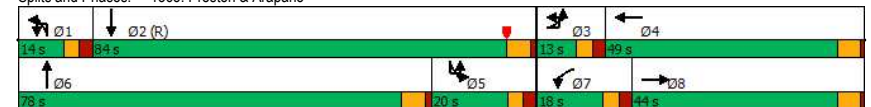

Pepper Square TIA  
Lanes, Volumes, Timings

Phase 1 & P - 2028 Background - AM  
1365: Preston & Arapaho

Lane Group	SBL	SBT	SBR
Total Split (%)	12.5%	52.5%	
Maximum Green (s)	14.5	78.3	
Yellow Time (s)	3.0	4.7	
All-Red Time (s)	2.5	1.0	
Lost Time Adjust (s)	-1.0	-1.7	
Total Lost Time (s)	4.5	4.0	
Lead/Lag	Lag	Lag	
Lead-Lag Optimize?	Yes	Yes	
Vehicle Extension (s)	1.5	1.5	
Recall Mode	None	C-Max	
Walk Time (s)		4.0	
Flash Dont Walk (s)		28.0	
Pedestrian Calls (#/hr)		0	
Act Effect Green (s)	15.5	80.3	
Actuated g/C Ratio	0.10	0.50	
v/c Ratio	0.33	0.86	
Control Delay	79.1	46.1	
Queue Delay	0.0	0.0	
Total Delay	79.1	46.1	
LOS	E	D	
Approach Delay		47.6	
Approach LOS		D	
Queue Length 50th (ft)	56	769	
Queue Length 95th (ft)	m70	858	
Internal Link Dist (ft)		5007	
Turn Bay Length (ft)	250		
Base Capacity (vph)	332	2520	
Starvation Cap Reductn	0	0	
Spillback Cap Reductn	0	0	
Storage Cap Reductn	0	0	
Reduced v/c Ratio	0.33	0.86	

Intersection Summary

Pepper Square TIA  
Lanes, Volumes, Timings

Phase 1 & P - 2028 Background - AM  
1367: Preston & Belt Line

Lane Group	EBU	EBL	EBT	EBR	WBL	WBT	WBR	NBL	NBT	NBR	SBU	SBL
Lane Configurations		↑↑	↑↑↑	↑	↑	↑↑↑	↑	↑↑	↑↑↑	↑		↑
Traffic Volume (vph)	10	154	404	222	68	851	124	270	1611	22	2	135
Future Volume (vph)	10	154	404	222	68	851	124	270	1611	22	2	135
Ideal Flow (vphpl)	1900	1900	1900	1900	1900	1900	1900	1900	1900	1900	1900	1900
Storage Length (ft)		150		150	200		0	250		0		200
Storage Lanes		2		1	1		0	2		0		1
Taper Length (ft)		25			25			25				25
Lane Util. Factor	0.91	0.97	0.91	1.00	1.00	0.91	0.91	0.97	0.91	0.91	0.91	1.00
Frt				0.850				0.981		0.998		
Fit Protected		0.950			0.950			0.950				0.950
Satd. Flow (prot)	0	3433	5085	1583	1770	4989	0	3433	5075	0	0	1770
Fit Permitted		0.950			0.950			0.950				0.950
Satd. Flow (perm)	0	3433	5085	1583	1770	4989	0	3433	5075	0	0	1770
Right Turn on Red				Yes		Yes			Yes			Yes
Satd. Flow (RTOR)				206		16			2			
Link Speed (mph)			42			42			42			
Link Distance (ft)			925			394			261			
Travel Time (s)			15.0			6.4			4.2			
Peak Hour Factor	0.95	0.95	0.95	0.95	0.95	0.95	0.95	0.95	0.95	0.95	0.95	0.95
Adj. Flow (vph)	11	162	425	234	72	896	131	284	1696	23	2	142
Shared Lane Traffic (%)												
Lane Group Flow (vph)	0	173	425	234	72	1027	0	284	1719	0	0	144
Enter Blocked Intersection	No	No	No	No	No	No	No	No	No	No	No	No
Lane Alignment	R NA	Left	Left	Right	Left	Left	Right	Left	Left	Right	R NA	Left
Median Width(ft)			24			24			24			
Link Offset(ft)			0			0			0			
Crosswalk Width(ft)				16		16			16			
Two way Left Turn Lane												
Headway Factor	1.00	1.00	1.00	1.00	1.00	1.00	1.00	1.00	1.00	1.00	1.00	1.00
Turning Speed (mph)	9	15		9	15		9	15		9	9	15
Number of Detectors	1	1	1	1	1	1	1	1	1	1	1	1
Detector Template												
Leading Detector (ft)	50	50	50	50	50	50		50	50		50	50
Trailing Detector (ft)	0	0	0	0	0	0		0	0		0	0
Detector 1 Position(ft)	0	0	0	0	0	0		0	0		0	0
Detector 1 Size(ft)	50	50	50	50	50	50		50	50		50	50
Detector 1 Type	CI+Ex	CI+Ex	CI+Ex	CI+Ex	CI+Ex	CI+Ex		CI+Ex	CI+Ex		CI+Ex	CI+Ex
Detector 1 Channel												
Detector 1 Extend (s)	0.0	0.0	0.0	0.0	0.0	0.0		0.0	0.0		0.0	0.0
Detector 1 Queue (s)	0.0	0.0	0.0	0.0	0.0	0.0		0.0	0.0		0.0	0.0
Detector 1 Delay (s)	0.0	0.0	0.0	0.0	0.0	0.0		0.0	0.0		0.0	0.0
Turn Type	Prot	Prot	NA	Perm	Prot	NA		Prot	NA		Prot	Prot
Protected Phases	3	3	8		7	4		1	6		5	5
Permitted Phases				8								
Detector Phase	3	3	8	8	7	4		1	6		5	5
Switch Phase												
Minimum Initial (s)	3.0	3.0	18.0	18.0	3.0	18.0		3.0	18.0		3.0	3.0
Minimum Split (s)	11.0	11.0	32.5	32.5	8.0	32.5		8.0	33.0		11.0	11.0
Total Split (s)	16.0	16.0	42.0	42.0	20.0	46.0		18.0	76.0		22.0	22.0

Pepper Square TIA  
Lanes, Volumes, Timings

Phase 1 & P - 2028 Background - AM  
1367: Preston & Belt Line

Lane Group	SBT	SBR
Lane Configurations	↑↑↑	↑
Traffic Volume (vph)	1787	252
Future Volume (vph)	1787	252
Ideal Flow (vphpl)	1900	1900
Storage Length (ft)	300	
Storage Lanes	1	
Taper Length (ft)		
Lane Util. Factor	0.91	1.00
Frt	0.850	
Fit Protected		
Satd. Flow (prot)	5085	1583
Fit Permitted		
Satd. Flow (perm)	5085	1583
Right Turn on Red	Yes	
Satd. Flow (RTOR)	180	
Link Speed (mph)	40	
Link Distance (ft)	3054	
Travel Time (s)	52.1	
Peak Hour Factor	0.95	0.95
Adj. Flow (vph)	1881	265
Shared Lane Traffic (%)		
Lane Group Flow (vph)	1881	265
Enter Blocked Intersection	No	No
Lane Alignment	Left	Right
Median Width(ft)	24	
Link Offset(ft)	0	
Crosswalk Width(ft)	16	
Two way Left Turn Lane		
Headway Factor	1.00	1.00
Turning Speed (mph)	9	
Number of Detectors	1	1
Detector Template		
Leading Detector (ft)	50	50
Trailing Detector (ft)	0	0
Detector 1 Position(ft)	0	0
Detector 1 Size(ft)	50	50
Detector 1 Type	CI+Ex	CI+Ex
Detector 1 Channel		
Detector 1 Extend (s)	0.0	0.0
Detector 1 Queue (s)	0.0	0.0
Detector 1 Delay (s)	0.0	0.0
Turn Type	NA	Perm
Protected Phases	2	
Permitted Phases	2	
Detector Phase	2	2
Switch Phase		
Minimum Initial (s)	18.0	18.0
Minimum Split (s)	33.0	33.0
Total Split (s)	80.0	80.0

09/26/2022 4:33 pm  
Kimley-Horn

Synchro 11 Report  
Page 13

Pepper Square TIA  
Lanes, Volumes, Timings

Phase 1 & P - 2028 Background - AM  
1367: Preston & Belt Line

Lane Group	EBU	EBL	EBT	EBR	WBL	WBT	WBR	NBL	NBT	NBR	SBU	SBL
Total Split (%)	10.0%	10.0%	26.3%	26.3%	12.5%	28.8%		11.3%	47.5%		13.8%	13.8%
Maximum Green (s)	11.0	11.0	36.5	36.5	15.0	40.5		13.0	70.0		17.0	17.0
Yellow Time (s)	3.0	3.0	4.0	4.0	3.0	4.0		3.0	4.4		3.0	3.0
All-Red Time (s)	2.0	2.0	1.5	1.5	2.0	1.5		2.0	1.6		2.0	2.0
Lost Time Adjust (s)		-1.0	-1.5	-1.5	-1.0	-1.5		-1.0	-1.7			-1.0
Total Lost Time (s)		4.0	4.0	4.0	4.0	4.0		4.0	4.3			4.0
Lead/Lag	Lead	Lead	Lead	Lead	Lag	Lag		Lag	Lag		Lead	Lead
Lead-Lag Optimize?	Yes	Yes	Yes	Yes	Yes	Yes		Yes	Yes		Yes	Yes
Vehicle Extension (s)	1.3	1.3	1.3	1.3	1.0	1.3		1.6	2.0		1.5	1.5
Recall Mode	None	None	Max	Max	None	Max		None	C-Max		None	None
Walk Time (s)			7.0	7.0		7.0			7.0			
Flash Dont Walk (s)			20.0	20.0		20.0			20.0			
Pedestrian Calls (#/hr)			0	0		0			0			
Act Effect Green (s)		11.3	38.0	38.0	16.0	42.7		14.0	73.4			16.3
Actuated g/C Ratio		0.07	0.24	0.24	0.10	0.27		0.09	0.46			0.10
v/c Ratio		0.72	0.35	0.44	0.41	0.76		0.95	0.74			0.80
Control Delay		75.5	41.5	10.3	45.7	28.1		98.4	26.3			104.4
Queue Delay		0.0	0.0	0.0	0.0	0.0		0.0	0.9			0.0
Total Delay		75.5	41.5	10.3	45.7	28.1		98.4	27.2			104.4
LOS		E	D	B	D	C		F	C			F
Approach Delay			39.8			29.3			37.3			
Approach LOS			D			C			D			
Queue Length 50th (ft)		93	142	82	69	312		159	541			135
Queue Length 95th (ft)		136	181	143	131	406		#256	747			m173
Internal Link Dist (ft)			845			314			181			
Turn Bay Length (ft)		150		150	200			250				200
Base Capacity (vph)		257	1207	533	177	1344		300	2330			199
Starvation Cap Reductn		0	0	0	0	0		0	314			0
Spillback Cap Reductn		0	0	0	0	0		0	0			0
Storage Cap Reductn		0	0	0	0	0		0	0			0
Reduced v/c Ratio		0.67	0.35	0.44	0.41	0.76		0.95	0.85			0.72

Intersection Summary

Area Type: Other  
 Cycle Length: 160  
 Actuated Cycle Length: 160  
 Offset: 81 (51%), Referenced to phase 6:NBT, Start of Yellow  
 Natural Cycle: 90  
 Control Type: Actuated-Coordinated  
 Maximum v/c Ratio: 0.95  
 Intersection Signal Delay: 29.3  
 Intersection LOS: C  
 Intersection Capacity Utilization 79.7%  
 ICU Level of Service D  
 Analysis Period (min) 15  
 # 95th percentile volume exceeds capacity, queue may be longer.  
 Queue shown is maximum after two cycles.  
 m Volume for 95th percentile queue is metered by upstream signal.

Splits and Phases: 1367: Preston & Belt Line

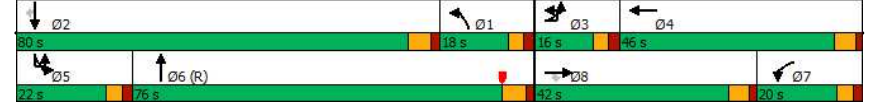

Pepper Square TIA  
Lanes, Volumes, Timings

Phase 1 & P - 2028 Background - AM  
1367: Preston & Belt Line

Lane Group	SBT	SBR
Total Split (%)	50.0%	50.0%
Maximum Green (s)	74.0	74.0
Yellow Time (s)	4.4	4.4
All-Red Time (s)	1.6	1.6
Lost Time Adjust (s)	-1.7	-1.7
Total Lost Time (s)	4.3	4.3
Lead/Lag	Lead	Lead
Lead-Lag Optimize?	Yes	Yes
Vehicle Extension (s)	2.5	2.5
Recall Mode	Max	Max
Walk Time (s)	7.0	7.0
Flash Dont Walk (s)	20.0	20.0
Pedestrian Calls (#/hr)	0	0
Act Effect Green (s)	75.7	75.7
Actuated g/C Ratio	0.47	0.47
v/c Ratio	0.78	0.31
Control Delay	14.4	1.0
Queue Delay	0.0	0.0
Total Delay	14.4	1.0
LOS	B	A
Approach Delay	18.5	
Approach LOS	B	
Queue Length 50th (ft)	336	1
Queue Length 95th (ft)	315	m3
Internal Link Dist (ft)	2974	
Turn Bay Length (ft)		300
Base Capacity (vph)	2405	843
Starvation Cap Reductn	0	0
Spillback Cap Reductn	0	0
Storage Cap Reductn	0	0
Reduced v/c Ratio	0.78	0.31

Intersection Summary

Pepper Square TIA  
Lanes, Volumes, Timings

Phase 1 & P - 2028 Background - AM  
1368: Preston & Alexis

Lane Group	EBL	EBT	EBR	WBL	WBT	WBR	NBU	NBL	NBT	NBR	SBL	SBT
Lane Configurations												
Traffic Volume (vph)	16	5	28	193	22	78	3	21	1876	93	89	1946
Future Volume (vph)	16	5	28	193	22	78	3	21	1876	93	89	1946
Ideal Flow (vphpl)	1900	1900	1900	1900	1900	1900	1900	1900	1900	1900	1900	1900
Storage Length (ft)	0		0	175		0		150		150	150	
Storage Lanes	1		1	2		1		1		1	1	
Taper Length (ft)	25			25				25			25	
Lane Util. Factor	0.91	0.91	1.00	0.97	1.00	1.00	0.91	1.00	0.91	1.00	1.00	0.91
Frt			0.850			0.850				0.850		
Fit Protected	0.950	0.969		0.950				0.950			0.950	
Satd. Flow (prot)	1610	3285	1583	3433	1863	1583	0	1770	5085	1583	1770	5085
Fit Permitted	0.950	0.969		0.950				0.065			0.065	
Satd. Flow (perm)	1610	3285	1583	3433	1863	1583	0	121	5085	1583	121	5085
Right Turn on Red			Yes			Yes				Yes		
Satd. Flow (RTOR)			125			85				89		
Link Speed (mph)		30			30				43			42
Link Distance (ft)		660			627				2867			173
Travel Time (s)		15.0			14.3				45.5			2.8
Peak Hour Factor	0.92	0.92	0.92	0.92	0.92	0.92	0.92	0.92	0.92	0.92	0.92	0.92
Adj. Flow (vph)	17	5	30	210	24	85	3	23	2039	101	97	2115
Shared Lane Traffic (%)	50%											
Lane Group Flow (vph)	8	14	30	210	24	85	0	26	2039	101	97	2115
Enter Blocked Intersection	No	No	No	No	No	No	No	No	No	No	No	No
Lane Alignment	Left	Left	Right	Left	Left	Right	R NA	Left	Left	Right	Left	Left
Median Width(ft)		24			24				12			12
Link Offset(ft)		0			0				0			0
Crosswalk Width(ft)		16			16				16			16
Two way Left Turn Lane												
Headway Factor	1.00	1.00	1.00	1.00	1.00	1.00	1.00	1.00	1.00	1.00	1.00	1.00
Turning Speed (mph)	15		9	15		9	9	15		9	15	
Number of Detectors	1	1	1	1	1	1	1	1	1	1	1	1
Detector Template												
Leading Detector (ft)	50	50	50	50	50	50	50	50	50	50	50	50
Trailing Detector (ft)	0	0	0	0	0	0	0	0	0	0	0	0
Detector 1 Position(ft)	0	0	0	0	0	0	0	0	0	0	0	0
Detector 1 Size(ft)	50	50	50	50	50	50	50	50	50	50	50	50
Detector 1 Type	Cl+Ex	Cl+Ex	Cl+Ex	Cl+Ex	Cl+Ex	Cl+Ex	Cl+Ex	Cl+Ex	Cl+Ex	Cl+Ex	Cl+Ex	Cl+Ex
Detector 1 Channel												
Detector 1 Extend (s)	0.0	0.0	0.0	0.0	0.0	0.0	0.0	0.0	0.0	0.0	0.0	0.0
Detector 1 Queue (s)	0.0	0.0	0.0	0.0	0.0	0.0	0.0	0.0	0.0	0.0	0.0	0.0
Detector 1 Delay (s)	0.0	0.0	0.0	0.0	0.0	0.0	0.0	0.0	0.0	0.0	0.0	0.0
Turn Type	Split	NA	Perm	Split	NA	pm+ov	custom	D,P+P	NA	Perm	D,P+P	NA
Protected Phases	3	3		4	4	5		1	6		5	2
Permitted Phases			3			4	1	2		6		6
Detector Phase	3	3	3	4	4	5	1	1	6	6	5	2
Switch Phase												
Minimum Initial (s)	6.0	6.0	6.0	8.0	8.0	3.0	3.0	3.0	14.0	14.0	3.0	14.0
Minimum Split (s)	27.0	27.0	27.0	27.0	27.0	8.4	8.4	8.4	24.0	24.0	8.4	24.0
Total Split (s)	13.0	13.0	13.0	29.0	29.0	15.0	18.0	18.0	103.0	103.0	15.0	100.0

Pepper Square TIA  
Lanes, Volumes, Timings

Phase 1 & P - 2028 Background - AM  
1368: Preston & Alexis

Lane Group	SBR
Left Configurations	↑
Traffic Volume (vph)	23
Future Volume (vph)	23
Ideal Flow (vphpl)	1900
Storage Length (ft)	150
Storage Lanes	1
Taper Length (ft)	
Lane Util. Factor	1.00
Frt	0.850
Fit Protected	
Satd. Flow (prot)	1583
Fit Permitted	
Satd. Flow (perm)	1583
Right Turn on Red	Yes
Satd. Flow (RTOR)	78
Link Speed (mph)	
Link Distance (ft)	
Travel Time (s)	
Peak Hour Factor	0.92
Adj. Flow (vph)	25
Shared Lane Traffic (%)	
Lane Group Flow (vph)	25
Enter Blocked Intersection	No
Lane Alignment	Right
Median Width(ft)	
Link Offset(ft)	
Crosswalk Width(ft)	
Two way Left Turn Lane	
Headway Factor	1.00
Turning Speed (mph)	9
Number of Detectors	1
Detector Template	
Leading Detector (ft)	50
Trailing Detector (ft)	0
Detector 1 Position(ft)	0
Detector 1 Size(ft)	50
Detector 1 Type	CI+Ex
Detector 1 Channel	
Detector 1 Extend (s)	0.0
Detector 1 Queue (s)	0.0
Detector 1 Delay (s)	0.0
Turn Type	Perm
Protected Phases	
Permitted Phases	2
Detector Phase	2
Switch Phase	
Minimum Initial (s)	14.0
Minimum Split (s)	24.0
Total Split (s)	100.0

Pepper Square TIA  
Lanes, Volumes, Timings

Phase 1 & P - 2028 Background - AM  
1368: Preston & Alexis

Lane Group	EBL	EBT	EBR	WBL	WBT	WBR	NBU	NBL	NBT	NBR	SBL	SBT
Total Split (%)	8.1%	8.1%	8.1%	18.1%	18.1%	9.4%	11.3%	11.3%	64.4%	64.4%	9.4%	62.5%
Maximum Green (s)	8.0	8.0	8.0	24.0	24.0	10.6	13.6	13.6	97.0	97.0	10.6	94.0
Yellow Time (s)	4.0	4.0	4.0	4.0	4.0	3.4	3.4	3.4	4.5	4.5	3.4	4.5
All-Red Time (s)	1.0	1.0	1.0	1.0	1.0	1.0	1.0	1.0	1.5	1.5	1.0	1.5
Lost Time Adjust (s)	-1.0	-1.0	0.0	-1.0	-1.0	0.0			-1.0	-2.0	0.0	-1.0
Total Lost Time (s)	4.0	4.0	5.0	4.0	4.0	4.4			3.4	4.0	6.0	3.4
Lead/Lag	Lead	Lead	Lead	Lag	Lag	Lag	Lead	Lead	Lead	Lead	Lag	Lag
Lead-Lag Optimize?	Yes	Yes	Yes	Yes	Yes	Yes	Yes	Yes	Yes	Yes	Yes	Yes
Vehicle Extension (s)	2.0	2.0	2.0	2.0	2.0	1.2	1.2	1.2	2.5	2.5	1.2	2.5
Recall Mode	None	None	None	None	None	None	None	None	Max	Max	None	C-Max
Walk Time (s)	4.0	4.0	4.0	4.0	4.0				4.0	4.0		4.0
Flash Dont Walk (s)	18.0	18.0	18.0	18.0	18.0				14.0	14.0		14.0
Pedestrian Calls (#/hr)	0	0	0	0	0				0	0		0
Act Effect Green (s)	7.2	7.2	6.2	15.2	15.2	26.2		126.4	112.9	110.9	125.1	122.5
Actuated g/C Ratio	0.04	0.04	0.04	0.10	0.10	0.16		0.79	0.71	0.69	0.78	0.77
v/c Ratio	0.11	0.10	0.17	0.65	0.14	0.26		0.17	0.57	0.09	0.46	0.54
Control Delay	76.7	74.6	2.0	79.0	66.7	10.0		5.0	6.2	0.3	18.7	1.2
Queue Delay	0.0	0.0	0.0	0.0	0.0	0.0		0.0	0.0	0.0	0.0	0.0
Total Delay	76.7	74.6	2.0	79.0	66.7	10.0		5.0	6.2	0.3	18.7	1.3
LOS	E	E	A	E	E	A		A	A	A	B	A
Approach Delay		33.0			59.7				6.0			2.0
Approach LOS		C			E				A			A
Queue Length 50th (ft)	8	7	0	111	23	0		2	232	1	31	24
Queue Length 95th (ft)	30	21	0	153	54	44		6	218	0	80	29
Internal Link Dist (ft)		580			547				2787			93
Turn Bay Length (ft)				175				150		150		
Base Capacity (vph)	90	184	197	536	291	330		247	3586	1123	213	3893
Starvation Cap Reductn	0	0	0	0	0	0		0	0	0	0	211
Spillback Cap Reductn	0	0	0	0	0	0		0	0	0	0	0
Storage Cap Reductn	0	0	0	0	0	0		0	0	0	0	0
Reduced v/c Ratio	0.09	0.08	0.15	0.39	0.08	0.26		0.11	0.57	0.09	0.46	0.57

Intersection Summary

Area Type: Other  
 Cycle Length: 160  
 Actuated Cycle Length: 160  
 Offset: 89 (56%), Referenced to phase 2:NBSB, Start of Yellow  
 Natural Cycle: 110  
 Control Type: Actuated-Coordinated  
 Maximum v/c Ratio: 0.65  
 Intersection Signal Delay: 8.0  
 Intersection LOS: A  
 Intersection Capacity Utilization 66.8%  
 ICU Level of Service C  
 Analysis Period (min) 15  
 m Volume for 95th percentile queue is metered by upstream signal.

Splits and Phases: 1368: Preston & Alexis



Pepper Square TIA  
Lanes, Volumes, Timings

Phase 1 & P - 2028 Background - AM  
1368: Preston & Alexis

Lane Group	SBR
Total Split (%)	62.5%
Maximum Green (s)	94.0
Yellow Time (s)	4.5
All-Red Time (s)	1.5
Lost Time Adjust (s)	0.0
Total Lost Time (s)	6.0
Lead/Lag	Lag
Lead-Lag Optimize?	Yes
Vehicle Extension (s)	2.5
Recall Mode	C-Max
Walk Time (s)	4.0
Flash Dont Walk (s)	14.0
Pedestrian Calls (#/hr)	0
Act Effect Green (s)	120.5
Actuated g/C Ratio	0.75
v/c Ratio	0.02
Control Delay	0.0
Queue Delay	0.0
Total Delay	0.0
LOS	A
Approach Delay	
Approach LOS	
Queue Length 50th (ft)	0
Queue Length 95th (ft)	m0
Internal Link Dist (ft)	
Turn Bay Length (ft)	150
Base Capacity (vph)	1211
Starvation Cap Reductn	0
Spillback Cap Reductn	0
Storage Cap Reductn	0
Reduced v/c Ratio	0.02

Intersection Summary

Pepper Square TIA  
Lanes, Volumes, Timings

Phase 1 & P - 2028 Background - AM  
1369: Preston & Belt Line Village Driveway

Lane Group	EBL	EBT	EBR	WBL	WBT	WBR	NBL	NBT	NBR	SBU	SBL	SBT
Lane Configurations		↕↕			↕↕		↕↕	↕↕↕				↕↕↕
Traffic Volume (vph)	40	1	28	4	2	0	25	1838	3	3	8	2075
Future Volume (vph)	40	1	28	4	2	0	25	1838	3	3	8	2075
Ideal Flow (vphpl)	1900	1900	1900	1900	1900	1900	1900	1900	1900	1900	1900	1900
Storage Length (ft)	0		0	0		0	100		0		100	
Storage Lanes	0		0	0		0	1		0		1	
Taper Length (ft)	25			25			25				25	
Lane Util. Factor	0.95	0.95	0.95	1.00	1.00	1.00	1.00	0.91	0.91	0.91	1.00	0.91
Fit		0.939										0.998
Fit Protected		0.972			0.968		0.950				0.950	
Satd. Flow (prot)	0	3230	0	0	1803	0	1770	5085	0	0	1770	5075
Fit Permitted		0.806			0.884		0.050				0.067	
Satd. Flow (perm)	0	2679	0	0	1647	0	93	5085	0	0	125	5075
Right Turn on Red			Yes			Yes			Yes			
Satd. Flow (RTOR)		31										2
Link Speed (mph)		30			30			42				38
Link Distance (ft)		303			249			252				191
Travel Time (s)		6.9			5.7			4.1				3.4
Peak Hour Factor	0.90	0.90	0.90	0.90	0.90	0.90	0.90	0.90	0.90	0.90	0.90	0.90
Adj. Flow (vph)	44	1	31	4	2	0	28	2042	3	3	9	2306
Shared Lane Traffic (%)												
Lane Group Flow (vph)	0	76	0	0	6	0	28	2045	0	0	12	2338
Enter Blocked Intersection	No	No	No	No	No	No	No	No	No	No	No	No
Lane Alignment	Left	Left	Right	Left	Left	Right	Left	Left	Right	R NA	Left	Left
Median Width(ft)		0			0			12				12
Link Offset(ft)		0			0			0				0
Crosswalk Width(ft)		16			16			16				16
Two way Left Turn Lane												
Headway Factor	1.00	1.00	1.00	1.00	1.00	1.00	1.00	1.00	1.00	1.00	1.00	1.00
Turning Speed (mph)	15		9	15		9	15		9	9	15	
Number of Detectors	1	1		1	1		1	1		1	1	1
Detector Template												
Leading Detector (ft)	50	50		50	50		50	50		50	50	50
Trailing Detector (ft)	0	0		0	0		0	0		0	0	0
Detector 1 Position(ft)	0	0		0	0		0	0		0	0	0
Detector 1 Size(ft)	50	50		50	50		50	50		50	50	50
Detector 1 Type	CI+Ex	CI+Ex		CI+Ex	CI+Ex		CI+Ex	CI+Ex		CI+Ex	CI+Ex	CI+Ex
Detector 1 Channel												
Detector 1 Extend (s)	0.0	0.0		0.0	0.0		0.0	0.0		0.0	0.0	0.0
Detector 1 Queue (s)	0.0	0.0		0.0	0.0		0.0	0.0		0.0	0.0	0.0
Detector 1 Delay (s)	0.0	0.0		0.0	0.0		0.0	0.0		0.0	0.0	0.0
Turn Type	Perm	NA		Perm	NA		D.P+P	NA		custom	D.P+P	NA
Protected Phases		8			4		1	6			5	2
Permitted Phases	8			4			2			5	6	
Detector Phase	8	8		4	4		1	6		5	5	2
Switch Phase												
Minimum Initial (s)	20.0	20.0		20.0	20.0		5.0	20.0		5.0	5.0	20.0
Minimum Split (s)	25.0	25.0		25.0	25.0		10.0	26.0		10.0	10.0	26.0
Total Split (s)	47.0	47.0		47.0	47.0		20.0	98.0		15.0	15.0	93.0



Pepper Square TIA  
Lanes, Volumes, Timings

Phase 1 & P - 2028 Background - AM  
1369: Preston & Belt Line Village Driveway

Lane Group	SBR
Link Configurations	
Traffic Volume (vph)	29
Future Volume (vph)	29
Ideal Flow (vphpl)	1900
Storage Length (ft)	0
Storage Lanes	0
Taper Length (ft)	
Lane Util. Factor	0.91
Frnt	
Fit Protected	
Satd. Flow (prot)	0
Fit Permitted	
Satd. Flow (perm)	0
Right Turn on Red	Yes
Satd. Flow (RTOR)	
Link Speed (mph)	
Link Distance (ft)	
Travel Time (s)	
Peak Hour Factor	0.90
Adj. Flow (vph)	32
Shared Lane Traffic (%)	
Lane Group Flow (vph)	0
Enter Blocked Intersection	No
Lane Alignment	Right
Median Width(ft)	
Link Offset(ft)	
Crosswalk Width(ft)	
Two way Left Turn Lane	
Headway Factor	1.00
Turning Speed (mph)	9
Number of Detectors	
Detector Template	
Leading Detector (ft)	
Trailing Detector (ft)	
Detector 1 Position(ft)	
Detector 1 Size(ft)	
Detector 1 Type	
Detector 1 Channel	
Detector 1 Extend (s)	
Detector 1 Queue (s)	
Detector 1 Delay (s)	
Turn Type	
Protected Phases	
Permitted Phases	
Detector Phase	
Switch Phase	
Minimum Initial (s)	
Minimum Split (s)	
Total Split (s)	

Pepper Square TIA  
Lanes, Volumes, Timings

Phase 1 & P - 2028 Background - AM  
1369: Preston & Belt Line Village Driveway

Lane Group	EBL	EBT	EBR	WBL	WBT	WBR	NBL	NBT	NBR	SBU	SBL	SBT
Total Split (%)	29.4%	29.4%		29.4%	29.4%		12.5%	61.3%		9.4%	9.4%	58.1%
Maximum Green (s)	42.3	42.3		42.3	42.3		15.0	93.7		10.0	10.0	88.7
Yellow Time (s)	3.0	3.0		3.0	3.0		3.0	3.0		3.0	3.0	3.0
All-Red Time (s)	1.7	1.7		1.7	1.7		2.0	1.3		2.0	2.0	1.3
Lost Time Adjust (s)		-1.0			-1.0		-1.0	-2.0			-1.0	-2.0
Total Lost Time (s)		3.7			3.7		4.0	2.3			4.0	2.3
Lead/Lag							Lead	Lead		Lag	Lag	Lag
Lead-Lag Optimize?							Yes	Yes		Yes	Yes	Yes
Vehicle Extension (s)	2.0	2.0		2.0	2.0		1.5	3.0		1.5	1.5	3.3
Recall Mode	None	None		None	None		None	None		None	None	C-Max
Walk Time (s)	5.0	5.0		5.0	5.0		7.0					7.0
Flash Dont Walk (s)	15.0	15.0		15.0	15.0		8.0					8.0
Pedestrian Calls (#/hr)	0	0		0	0		0					0
Act Effect Green (s)		21.0			21.0		128.9	118.1			129.7	127.0
Actuated g/C Ratio		0.13			0.13		0.81	0.74			0.81	0.79
v/c Ratio		0.20			0.03		0.20	0.54			0.04	0.58
Control Delay		39.2			61.2		6.0	6.5			1.1	2.7
Queue Delay		0.0			0.0		0.0	0.0			0.0	0.1
Total Delay		39.2			61.2		6.0	6.5			1.1	2.8
LOS		D			E		A	A			A	A
Approach Delay		39.2			61.2			6.5				2.8
Approach LOS		D			E			A				A
Queue Length 50th (ft)		22			6		1	24			1	62
Queue Length 95th (ft)		50			22		m2	246			m1	71
Internal Link Dist (ft)		223			169			172				111
Turn Bay Length (ft)							100				100	
Base Capacity (vph)		747			445		244	3759			305	4027
Starvation Cap Reductn		0			0		0	124			0	331
Spillback Cap Reductn		0			0		0	208			0	0
Storage Cap Reductn		0			0		0	0			0	0
Reduced v/c Ratio		0.10			0.01		0.11	0.58			0.04	0.63

Intersection Summary

Area Type: Other  
 Cycle Length: 160  
 Actuated Cycle Length: 160  
 Offset: 86 (54%), Referenced to phase 2:NBSB, Start of Yellow  
 Natural Cycle: 70  
 Control Type: Actuated-Coordinated  
 Maximum v/c Ratio: 0.58  
 Intersection Signal Delay: 5.2 Intersection LOS: A  
 Intersection Capacity Utilization 64.1% ICU Level of Service C  
 Analysis Period (min) 15  
 m Volume for 95th percentile queue is metered by upstream signal.

Splits and Phases: 1369: Preston & Belt Line Village Driveway

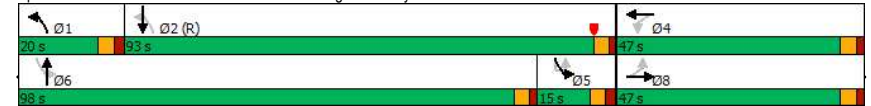

Pepper Square TIA  
Lanes, Volumes, Timings

Phase 1 & P - 2028 Background - AM  
1369: Preston & Belt Line Village Driveway

Lane Group	SBR
Total Split (%)	
Maximum Green (s)	
Yellow Time (s)	
All-Red Time (s)	
Lost Time Adjust (s)	
Total Lost Time (s)	
Lead/Lag	
Lead-Lag Optimize?	
Vehicle Extension (s)	
Recall Mode	
Walk Time (s)	
Flash Dont Walk (s)	
Pedestrian Calls (#/hr)	
Act Effect Green (s)	
Actuated g/C Ratio	
v/c Ratio	
Control Delay	
Queue Delay	
Total Delay	
LOS	
Approach Delay	
Approach LOS	
Queue Length 50th (ft)	
Queue Length 95th (ft)	
Internal Link Dist (ft)	
Turn Bay Length (ft)	
Base Capacity (vph)	
Starvation Cap Reductn	
Spillback Cap Reductn	
Storage Cap Reductn	
Reduced v/c Ratio	
Intersection Summary	

Pepper Square TIA  
Lanes, Volumes, Timings

Phase 1 & P - 2028 Background - AM  
1371: Preston & Spring Valley

Lane Group	EBL	EBT	EBR	WBL	WBT	WBR	NBL	NBT	NBR	SBU	SBL	SBT
Lane Configurations	↑↑	↑↑↑		↑↑	↑↑↑		↑↑	↑↑↑			↑↑	↑↑↑
Traffic Volume (vph)	147	366	253	90	736	147	115	1579	76	1	148	2025
Future Volume (vph)	147	366	253	90	736	147	115	1579	76	1	148	2025
Ideal Flow (vphpl)	1900	1900	1900	1900	1900	1900	1900	1900	1900	1900	1900	1900
Storage Length (ft)	225		0	225		0	225		0		275	
Storage Lanes	2		0	2		0	2		0		2	
Taper Length (ft)	25			25			25				25	
Lane Util. Factor	0.97	0.91	0.91	0.97	0.91	0.91	0.97	0.91	0.91	0.91	0.97	0.91
Fr		0.939			0.975			0.993				0.987
Fit Protected	0.950			0.950			0.950				0.950	
Satd. Flow (prot)	3433	4775	0	3433	4958	0	3433	5050	0	0	3433	5019
Fit Permitted	0.950			0.950			0.950				0.950	
Satd. Flow (perm)	3433	4775	0	3433	4958	0	3433	5050	0	0	3433	5019
Right Turn on Red			Yes			Yes			Yes			
Satd. Flow (RTOR)		103			25			6				14
Link Speed (mph)		38			42			41				38
Link Distance (ft)		3259			5488			2139				1208
Travel Time (s)		58.5			89.1			35.6				21.7
Peak Hour Factor	0.96	0.96	0.96	0.96	0.96	0.96	0.96	0.96	0.96	0.96	0.96	0.96
Adj. Flow (vph)	153	381	264	94	767	153	120	1645	79	1	154	2109
Shared Lane Traffic (%)												
Lane Group Flow (vph)	153	645	0	94	920	0	120	1724	0	0	155	2305
Enter Blocked Intersection	No	No	No	No	No	No	No	No	No	No	No	No
Lane Alignment	Left	Left	Right	Left	Left	Right	Left	Left	Right	R NA	Left	Left
Median Width(ft)		24			24			24				24
Link Offset(ft)		0			0			0				0
Crosswalk Width(ft)		16			16			16				16
Two way Left Turn Lane												
Headway Factor	1.00	1.00	1.00	1.00	1.00	1.00	1.00	1.00	1.00	1.00	1.00	1.00
Turning Speed (mph)	15		9	15		9	15		9	9	15	
Number of Detectors	1	1		1	1		1	1		1	1	1
Detector Template												
Leading Detector (ft)	50	50		50	50		50	50		50	50	50
Trailing Detector (ft)	0	0		0	0		0	0		0	0	0
Detector 1 Position(ft)	0	0		0	0		0	0		0	0	0
Detector 1 Size(ft)	50	50		50	50		50	50		50	50	50
Detector 1 Type	CI+Ex	CI+Ex		CI+Ex	CI+Ex		CI+Ex	CI+Ex		CI+Ex	CI+Ex	CI+Ex
Detector 1 Channel												
Detector 1 Extend (s)	0.0	0.0		0.0	0.0		0.0	0.0		0.0	0.0	0.0
Detector 1 Queue (s)	0.0	0.0		0.0	0.0		0.0	0.0		0.0	0.0	0.0
Detector 1 Delay (s)	0.0	0.0		0.0	0.0		0.0	0.0		0.0	0.0	0.0
Turn Type	Prot	NA		Prot	NA		Prot	NA		Prot	Prot	NA
Protected Phases	3	8		7	4		1	6		5	5	2
Permitted Phases												
Detector Phase	3	8		7	4		1	6		5	5	2
Switch Phase												
Minimum Initial (s)	6.0	12.0		3.0	12.0		3.0	13.0		3.0	3.0	18.0
Minimum Split (s)	11.0	27.5		11.0	27.5		11.0	28.0		11.0	11.0	28.0
Total Split (s)	15.0	43.0		16.0	44.0		13.0	71.0		30.0	30.0	88.0

Pepper Square TIA  
Lanes, Volumes, Timings

Phase 1 & P - 2028 Background - AM  
1371: Preston & Spring Valley

Lane Group	SBR
Configuration	
Traffic Volume (vph)	188
Future Volume (vph)	188
Ideal Flow (vphpl)	1900
Storage Length (ft)	0
Storage Lanes	0
Taper Length (ft)	
Lane Util. Factor	0.91
Frnt	
Fit Protected	
Satd. Flow (prot)	0
Fit Permitted	
Satd. Flow (perm)	0
Right Turn on Red	Yes
Satd. Flow (RTOR)	
Link Speed (mph)	
Link Distance (ft)	
Travel Time (s)	
Peak Hour Factor	0.96
Adj. Flow (vph)	196
Shared Lane Traffic (%)	
Lane Group Flow (vph)	0
Enter Blocked Intersection	No
Lane Alignment	Right
Median Width(ft)	
Link Offset(ft)	
Crosswalk Width(ft)	
Two way Left Turn Lane	
Headway Factor	1.00
Turning Speed (mph)	9
Number of Detectors	
Detector Template	
Leading Detector (ft)	
Trailing Detector (ft)	
Detector 1 Position(ft)	
Detector 1 Size(ft)	
Detector 1 Type	
Detector 1 Channel	
Detector 1 Extend (s)	
Detector 1 Queue (s)	
Detector 1 Delay (s)	
Turn Type	
Protected Phases	
Permitted Phases	
Detector Phase	
Switch Phase	
Minimum Initial (s)	
Minimum Split (s)	
Total Split (s)	

Pepper Square TIA  
Lanes, Volumes, Timings

Phase 1 & P - 2028 Background - AM  
1371: Preston & Spring Valley

Lane Group	EBL	EBT	EBR	WBL	WBT	WBR	NBL	NBT	NBR	SBU	SBL	SBT
Total Split (%)	9.4%	26.9%		10.0%	27.5%		8.1%	44.4%		18.8%	18.8%	55.0%
Maximum Green (s)	10.0	37.5		11.0	38.5		8.0	65.0		25.0	25.0	82.0
Yellow Time (s)	3.0	4.0		3.0	4.0		3.0	4.5		3.0	3.0	4.5
All-Red Time (s)	2.0	1.5		2.0	1.5		2.0	1.5		2.0	2.0	1.5
Lost Time Adjust (s)	-1.0	-1.5		-1.0	-1.5		-1.0	-2.0			-1.0	-2.0
Total Lost Time (s)	4.0	4.0		4.0	4.0		4.0	4.0			4.0	4.0
Lead/Lag	Lead	Lead		Lag	Lag		Lead	Lead		Lag	Lag	Lag
Lead-Lag Optimize?	Yes	Yes		Yes	Yes		Yes	Yes		Yes	Yes	Yes
Vehicle Extension (s)	0.8	2.0		0.8	2.0		0.8	2.5		0.8	0.8	2.4
Recall Mode	None	None		None	None		None	None		None	None	C-Max
Walk Time (s)		4.0			4.0			4.0				4.0
Flash Dont Walk (s)		18.0			18.0			18.0				18.0
Pedestrian Calls (#/hr)		0			0			0				0
Act Effect Green (s)	10.2	24.5		20.7	35.1		9.0	66.0			32.8	89.8
Actuated g/C Ratio	0.06	0.15		0.13	0.22		0.06	0.41			0.20	0.56
v/c Ratio	0.70	0.79		0.21	0.83		0.62	0.83			0.22	0.82
Control Delay	81.7	59.0		63.3	59.7		91.1	48.0			68.4	43.0
Queue Delay	0.0	0.0		0.0	0.0		0.0	0.0			0.0	0.0
Total Delay	81.7	59.0		63.3	59.7		91.1	48.0			68.4	43.0
LOS	F	E		E	E		F	D			E	D
Approach Delay		63.4			60.0			50.8				44.6
Approach LOS		E			E			D				D
Queue Length 50th (ft)	81	217		48	347		66	468			80	863
Queue Length 95th (ft)	123	254		m47	m323		m102	490			m114	963
Internal Link Dist (ft)		3179			5408			2059				1128
Turn Bay Length (ft)	225			225			225				275	
Base Capacity (vph)	236	1241		444	1258		205	2121			702	2821
Starvation Cap Reductn	0	0		0	0		0	0			0	0
Spillback Cap Reductn	0	0		0	0		0	0			0	0
Storage Cap Reductn	0	0		0	0		0	0			0	0
Reduced v/c Ratio	0.65	0.52		0.21	0.73		0.59	0.81			0.22	0.82

Intersection Summary

Area Type: Other  
 Cycle Length: 160  
 Actuated Cycle Length: 160  
 Offset: 156 (98%), Referenced to phase 2:SBT, Start of Yellow  
 Natural Cycle: 90  
 Control Type: Actuated-Coordinated  
 Maximum v/c Ratio: 0.83  
 Intersection Signal Delay: 51.5  
 Intersection LOS: D  
 Intersection Capacity Utilization 82.5%  
 ICU Level of Service E  
 Analysis Period (min) 15  
 m Volume for 95th percentile queue is metered by upstream signal.

Splits and Phases: 1371: Preston & Spring Valley

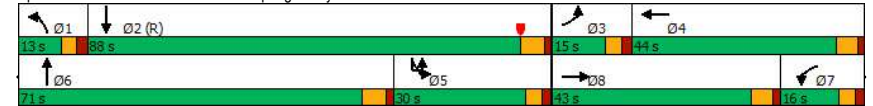

Pepper Square TIA  
Lanes, Volumes, Timings

Phase 1 & P - 2028 Background - AM  
1371: Preston & Spring Valley

Lane Group	SBR
Total Split (%)	
Maximum Green (s)	
Yellow Time (s)	
All-Red Time (s)	
Lost Time Adjust (s)	
Total Lost Time (s)	
Lead/Lag	
Lead-Lag Optimize?	
Vehicle Extension (s)	
Recall Mode	
Walk Time (s)	
Flash Dont Walk (s)	
Pedestrian Calls (#/hr)	
Act Effect Green (s)	
Actuated g/C Ratio	
v/c Ratio	
Control Delay	
Queue Delay	
Total Delay	
LOS	
Approach Delay	
Approach LOS	
Queue Length 50th (ft)	
Queue Length 95th (ft)	
Internal Link Dist (ft)	
Turn Bay Length (ft)	
Base Capacity (vph)	
Starvation Cap Reductn	
Spillback Cap Reductn	
Storage Cap Reductn	
Reduced v/c Ratio	
Intersection Summary	

Pepper Square TIA  
Lanes, Volumes, Timings

Phase 1 & P - 2028 Background - AM  
1405: Prestonwood & Belt Line

Lane Group	EBU	EBL	EBT	EBR	WBL	WBT	WBR	NBL	NBT	NBR	SBL	SBT
Lane Configurations		↕	↕↕		↕	↕↕			↕		↕↕	↕
Traffic Volume (vph)	4	41	749	3	4	1456	49	1	0	5	39	1
Future Volume (vph)	4	41	749	3	4	1456	49	1	0	5	39	1
Ideal Flow (vphpl)	1900	1900	1900	1900	1900	1900	1900	1900	1900	1900	1900	1900
Storage Length (ft)		200		0	200		0	0		0	300	
Storage Lanes		1		0	1		0	0		0	2	
Taper Length (ft)		25			25			25			25	
Lane Util. Factor	0.91	1.00	0.91	0.91	1.00	0.91	0.91	1.00	1.00	1.00	0.97	0.95
Fit			0.999			0.995			0.887		0.854	
Fit Protected		0.950		0.950				0.992		0.950		
Satd. Flow (prot)	0	1770	5080	0	1770	5060	0	0	1639	0	3433	1511
Fit Permitted		0.132		0.338				0.992		0.950		
Satd. Flow (perm)	0	246	5080	0	630	5060	0	0	1639	0	3433	1511
Right Turn on Red			Yes		Yes		Yes					
Satd. Flow (RTOR)			1		6		131				33	
Link Speed (mph)			42		42		30				30	
Link Distance (ft)			1445		2036		315				868	
Travel Time (s)			23.5		33.1		7.2				19.7	
Peak Hour Factor	0.95	0.95	0.95	0.95	0.95	0.95	0.95	0.95	0.95	0.95	0.95	0.95
Adj. Flow (vph)	4	43	788	3	4	1533	52	1	0	5	41	1
Shared Lane Traffic (%)												
Lane Group Flow (vph)	0	47	791	0	4	1585	0	0	6	0	41	34
Enter Blocked Intersection	No	No	No	No	No	No	No	No	No	No	No	No
Lane Alignment	R NA	Left	Left	Right	Left	Left	Right	Left	Left	Right	Left	Left
Median Width(ft)			24			24			24			24
Link Offset(ft)			0			0			0			0
Crosswalk Width(ft)			16			16			16			16
Two way Left Turn Lane												
Headway Factor	1.00	1.00	1.00	1.00	1.00	1.00	1.00	1.00	1.00	1.00	1.00	1.00
Turning Speed (mph)	9	15		9	15		9	15		9	15	
Number of Detectors	1	1	1		1	1		1	1		1	1
Detector Template												
Leading Detector (ft)	50	50	50		50	50		50	50		50	50
Trailing Detector (ft)	0	0	0		0	0		0	0		0	0
Detector 1 Position(ft)	0	0	0		0	0		0	0		0	0
Detector 1 Size(ft)	50	50	50		50	50		50	50		50	50
Detector 1 Type	CI+Ex	CI+Ex	CI+Ex		CI+Ex	CI+Ex		CI+Ex	CI+Ex		CI+Ex	CI+Ex
Detector 1 Channel												
Detector 1 Extend (s)	0.0	0.0	0.0		0.0	0.0		0.0	0.0		0.0	0.0
Detector 1 Queue (s)	0.0	0.0	0.0		0.0	0.0		0.0	0.0		0.0	0.0
Detector 1 Delay (s)	0.0	0.0	0.0		0.0	0.0		0.0	0.0		0.0	0.0
Turn Type	custom	D,P+P	NA		D,P+P	NA		Split	NA		Split	NA
Permitted Phases		1	6		5	2		3	3		4	4
Permitted Phases	1	2			6							
Detector Phase	1	1	6		5	2		3	3		4	4
Switch Phase												
Minimum Initial (s)	3.0	3.0	15.0		3.0	15.0		5.0	5.0		7.0	7.0
Minimum Split (s)	8.0	8.0	22.0		8.0	24.0		23.0	23.0		23.2	23.2
Total Split (s)	15.0	15.0	109.0		15.0	109.0		18.0	18.0		18.0	18.0

Pepper Square TIA  
Lanes, Volumes, Timings

Phase 1 & P - 2028 Background - AM  
1405: Prestonwood & Belt Line

Lane Group	SBR
Lane Configurations	↑
Traffic Volume (vph)	64
Future Volume (vph)	64
Ideal Flow (vphpl)	1900
Storage Length (ft)	0
Storage Lanes	1
Taper Length (ft)	
Lane Util. Factor	0.95
Frt	0.850
Fit Protected	
Satd. Flow (prot)	1504
Fit Permitted	
Satd. Flow (perm)	1504
Right Turn on Red	Yes
Satd. Flow (RTOR)	89
Link Speed (mph)	
Link Distance (ft)	
Travel Time (s)	
Peak Hour Factor	0.95
Adj. Flow (vph)	67
Shared Lane Traffic (%)	49%
Lane Group Flow (vph)	34
Enter Blocked Intersection	No
Lane Alignment	Right
Median Width(ft)	
Link Offset(ft)	
Crosswalk Width(ft)	
Two way Left Turn Lane	
Headway Factor	1.00
Turning Speed (mph)	9
Number of Detectors	1
Detector Template	
Leading Detector (ft)	50
Trailing Detector (ft)	0
Detector 1 Position(ft)	0
Detector 1 Size(ft)	50
Detector 1 Type	CI+Ex
Detector 1 Channel	
Detector 1 Extend (s)	0.0
Detector 1 Queue (s)	0.0
Detector 1 Delay (s)	0.0
Turn Type	custom
Protected Phases	
Permitted Phases	1 4
Detector Phase	1 4
Switch Phase	
Minimum Initial (s)	
Minimum Split (s)	
Total Split (s)	

Pepper Square TIA  
Lanes, Volumes, Timings

Phase 1 & P - 2028 Background - AM  
1405: Prestonwood & Belt Line

Lane Group	EBU	EBL	EBT	EBR	WBL	WBT	WBR	NBL	NBT	NBR	SBL	SBT
Total Split (%)	9.4%	9.4%	68.1%		9.4%	68.1%		11.3%	11.3%		11.3%	11.3%
Maximum Green (s)	10.0	10.0	103.0		10.0	103.0		13.0	13.0		12.8	12.8
Yellow Time (s)	3.0	3.0	4.5		3.0	4.5		3.0	3.0		3.2	3.2
All-Red Time (s)	2.0	2.0	1.5		2.0	1.5		2.0	2.0		2.0	2.0
Lost Time Adjust (s)		-1.0	-2.0		-1.0	-2.0		-1.0			-1.2	-1.2
Total Lost Time (s)		4.0	4.0		4.0	4.0		4.0			4.0	4.0
Lead/Lag	Lag	Lag	Lag		Lead	Lead		Lead	Lead		Lag	Lag
Lead-Lag Optimize?	Yes	Yes	Yes		Yes	Yes		Yes	Yes		Yes	Yes
Vehicle Extension (s)	1.0	1.0	2.5		1.0	2.5		1.5	1.5		1.5	1.5
Recall Mode	None	None	C-Max		None	Max		None	None		None	None
Walk Time (s)			5.0			4.0		4.0	4.0		4.0	4.0
Flash Dont Walk (s)			10.0			14.0		14.0	14.0		14.0	14.0
Pedestrian Calls (#/hr)			0			0		0	0		0	0
Act Effect Green (s)		141.7	143.1		143.3	132.9		6.0			8.4	8.4
Actuated g/C Ratio		0.89	0.89		0.90	0.83		0.04			0.05	0.05
v/c Ratio		0.15	0.17		0.01	0.38		0.03			0.23	0.31
Control Delay		4.1	1.5		0.8	1.8		0.3			75.9	29.8
Queue Delay		0.0	0.0		0.0	0.0		0.0			0.0	0.0
Total Delay		4.1	1.5		0.8	1.8		0.3			75.9	29.8
LOS		A	A		A	A		A			E	C
Approach Delay			1.7			1.8		0.3				38.2
Approach LOS			A			A		A				D
Queue Length 50th (ft)		3	21		0	54		0			21	1
Queue Length 95th (ft)		13	59		m1	m78		0			43	41
Internal Link Dist (ft)			1365			1956		235				788
Turn Bay Length (ft)		200			200						300	
Base Capacity (vph)		321	4544		645	4203		262			300	162
Starvation Cap Reductn		0	0		0	0		0			0	0
Spillback Cap Reductn		0	0		0	0		0			0	0
Storage Cap Reductn		0	0		0	0		0			0	0
Reduced v/c Ratio		0.15	0.17		0.01	0.38		0.02			0.14	0.21

Intersection Summary

Area Type: Other  
 Cycle Length: 160  
 Actuated Cycle Length: 160  
 Offset: 73 (46%), Referenced to phase 6:EBWB, Start of Yellow  
 Natural Cycle: 80  
 Control Type: Actuated-Coordinated  
 Maximum v/c Ratio: 0.38  
 Intersection Signal Delay: 3.3  
 Intersection Capacity Utilization 53.4%  
 Analysis Period (min) 15  
 m Volume for 95th percentile queue is metered by upstream signal.

Splits and Phases: 1405: Prestonwood & Belt Line

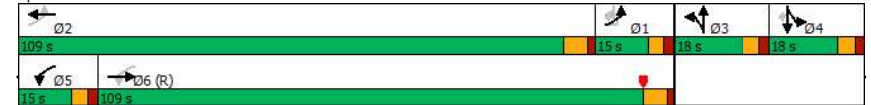

Lane Group	SBR
Total Split (%)	
Maximum Green (s)	
Yellow Time (s)	
All-Red Time (s)	
Lost Time Adjust (s)	
Total Lost Time (s)	
Lead/Lag	
Lead-Lag Optimize?	
Vehicle Extension (s)	
Recall Mode	
Walk Time (s)	
Flash Dont Walk (s)	
Pedestrian Calls (#/hr)	
Act Effect Green (s)	20.5
Actuated g/C Ratio	0.13
v/c Ratio	0.13
Control Delay	1.0
Queue Delay	0.0
Total Delay	1.0
LOS	A
Approach Delay	
Approach LOS	
Queue Length 50th (ft)	0
Queue Length 95th (ft)	0
Internal Link Dist (ft)	
Turn Bay Length (ft)	
Base Capacity (vph)	338
Starvation Cap Reductn	0
Spillback Cap Reductn	0
Storage Cap Reductn	0
Reduced v/c Ratio	0.10
Intersection Summary	

Pepper Square TIA  
HCM 6th TWSC

Phase 1 & P - 2028 Background - AM  
2: Ladera Drive & Belt Line

Intersection													
Int Delay, s/veh	6												
Movement	EBL	EBT	EBR	WBL	WBT	WBR	NBL	NBT	NBR	SBL	SBT	SBR	
Lane Configurations	↔ ↑↑↑			↔ ↑↑↑				↑		↑		↑	
Traffic Vol, veh/h	50	731	16	23	1340	22	41	0	65	43	0	109	
Future Vol, veh/h	50	731	16	23	1340	22	41	0	65	43	0	109	
Conflicting Peds, #/hr	0	0	0	0	0	0	0	0	0	0	0	0	
Sign Control	Free	Free	Free	Free	Free	Stop	Stop	Stop	Stop	Stop	Stop	Stop	
RT Channelized	-	-	None	-	-	None	-	-	None	-	-	None	
Storage Length	100	-	-	100	-	-	-	-	0	-	-	0	
Veh in Median Storage, #	-	0	-	-	0	-	-	-	1	-	-	1	
Grade, %	-	0	-	-	0	-	-	-	0	-	-	0	
Peak Hour Factor	91	91	91	91	91	91	91	91	91	91	91	91	
Heavy Vehicles, %	2	2	2	2	2	2	2	2	2	2	2	2	
Mvmt Flow	55	803	18	25	1473	24	45	0	71	47	0	120	

Major/Minor	Major1	Major2	Minor1	Minor2	
Conflicting Flow All	1497	0	0	821	0
Stage 1	-	-	-	-	922
Stage 2	-	-	-	-	639
Critical Hdwy	5.34	-	-	5.34	-
Critical Hdwy Stg 1	-	-	-	-	7.34
Critical Hdwy Stg 2	-	-	-	-	6.74
Follow-up Hdwy	3.12	-	-	3.12	-
Pot Cap-1 Maneuver	224	-	-	934	-
Stage 1	-	-	-	-	630
Stage 2	-	-	-	-	392
Platoon blocked, %	-	-	-	1	-
Mov Cap-1 Maneuver	224	-	-	934	-
Mov Cap-2 Maneuver	-	-	-	-	152
Stage 1	-	-	-	-	475
Stage 2	-	-	-	-	231

Approach	EB	WB	NB	SB
HCM Control Delay, s	1.6	0.1	21.2	72.4
HCM LOS			C	F

Minor Lane/Major Mvmt	NBLn1	NBLn2	EBL	EBT	EBR	WBL	WBT	WBR	SBLn1	SBLn2
Capacity (veh/h)	152	752	224	-	-	934	-	-	56	304
HCM Lane V/C Ratio	0.296	0.095	0.245	-	-	0.027	-	-	0.844	0.394
HCM Control Delay (s)	38.4	10.3	26.2	-	-	9	-	-	194.3	24.3
HCM Lane LOS	E	B	D	-	-	A	-	-	F	C
HCM 95th %tile Q(veh)	1.2	0.3	0.9	-	-	0.1	-	-	3.7	1.8

Notes  
 ~: Volume exceeds capacity    \$: Delay exceeds 300s    +: Computation Not Defined    \*: All major volume in platoon

Pepper Square TIA  
HCM 6th TWSC

Phase 1 & P - 2028 Background - AM  
3: Median Opening East of Preston Rd & Belt Line

Intersection													
Int Delay, s/veh	0.3												
Movement	EBU	EBL	EBT	EBR	WBL	WBT	WBR	NBL	NBT	NBR	SBL	SBT	SBR
Lane Configurations	↔ ↑↑↑			↔ ↑↑↑				↔		↔		↔	
Traffic Vol, veh/h	4	21	527	4	13	1053	18	1	2	0	1	0	3
Future Vol, veh/h	4	21	527	4	13	1053	18	1	2	0	1	0	3
Conflicting Peds, #/hr	0	0	0	0	0	0	0	0	0	0	0	0	0
Sign Control	Free	Free	Free	Free	Free	Free	Stop	Stop	Stop	Stop	Stop	Stop	Stop
RT Channelized	-	-	-	None	-	-	None	-	-	None	-	-	None
Storage Length	-	150	-	-	200	-	-	-	-	-	-	-	-
Veh in Median Storage, #	-	-	0	-	-	0	-	-	-	1	-	-	1
Grade, %	-	-	0	-	-	0	-	-	-	0	-	-	0
Peak Hour Factor	96	96	96	96	96	96	96	96	96	96	96	96	96
Heavy Vehicles, %	2	2	2	2	2	2	2	2	2	2	2	2	2
Mvmt Flow	4	22	549	4	14	1097	19	1	2	0	1	0	3

Major/Minor	Major1	Major2	Minor1	Minor2	
Conflicting Flow All	814	1116	0	0	553
Stage 1	-	-	-	-	603
Stage 2	-	-	-	-	467
Critical Hdwy	5.64	5.34	-	-	5.34
Critical Hdwy Stg 1	-	-	-	-	7.34
Critical Hdwy Stg 2	-	-	-	-	6.74
Follow-up Hdwy	2.32	3.12	-	-	3.12
Pot Cap-1 Maneuver	*1161	*864	-	-	639
Stage 1	-	-	-	-	373
Stage 2	-	-	-	-	705
Platoon blocked, %	1	1	-	-	1
Mov Cap-1 Maneuver	*900	*900	-	-	639
Mov Cap-2 Maneuver	-	-	-	-	603
Stage 1	-	-	-	-	362
Stage 2	-	-	-	-	686

Approach	EB	WB	NB	SB
HCM Control Delay, s	0.4	0.1	14.1	10.8
HCM LOS			B	B

Minor Lane/Major Mvmt	NBLn1	EBL	EBT	EBR	WBL	WBT	WBR	SBLn1
Capacity (veh/h)	399	*900	-	-	639	-	-	622
HCM Lane V/C Ratio	0.008	0.029	-	-	0.021	-	-	0.007
HCM Control Delay (s)	14.1	9.1	-	-	10.8	-	-	10.8
HCM Lane LOS	B	A	-	-	B	-	-	B
HCM 95th %tile Q(veh)	0	0.1	-	-	0.1	-	-	0

Notes  
 ~: Volume exceeds capacity    \$: Delay exceeds 300s    +: Computation Not Defined    \*: All major volume in platoon

Pepper Square TIA  
HCM 6th TWSC

Phase 1 & P - 2028 Background - AM  
5: Belt Line & Median between Berry Trail and Alexis Dr

Intersection												
Int Delay, s/veh	0.2											
Movement	EBL	EBT	EBR	WBL	WBT	WBR	NBL	NBT	NBR	SBL	SBT	SBR
Lane Configurations	↔ ↑↑↑			↔ ↑↑↑			↔			↔		
Traffic Vol, veh/h	5	562	0	11	1049	11	1	0	0	6	1	7
Future Vol, veh/h	5	562	0	11	1049	11	1	0	0	6	1	7
Conflicting Peds, #/hr	0	0	0	0	0	0	0	0	0	0	0	0
Sign Control	Free	Free	Free	Free	Free	Stop	Stop	Stop	Stop	Stop	Stop	Stop
RT Channelized	-	-	None	-	-	None	-	-	None	-	-	None
Storage Length	150	-	-	150	-	-	-	-	-	-	-	-
Veh in Median Storage, #	-	0	-	-	0	-	-	1	-	-	1	-
Grade, %	-	0	-	-	0	-	-	0	-	-	0	-
Peak Hour Factor	88	88	88	88	88	88	88	88	88	88	88	88
Heavy Vehicles, %	2	2	2	2	2	2	2	2	2	2	2	2
Mvmt Flow	6	639	0	13	1192	13	1	0	0	7	1	8

Major/Minor	Major1	Major2	Minor1	Minor2
Conflicting Flow All	1205	0	0	639
Stage 1	-	-	-	-
Stage 2	-	-	-	-
Critical Hdwy	5.34	-	-	5.34
Critical Hdwy Stg 1	-	-	-	-
Critical Hdwy Stg 2	-	-	-	-
Follow-up Hdwy	3.12	-	-	3.12
Pot Cap-1 Maneuver	777	-	-	929
Stage 1	-	-	-	-
Stage 2	-	-	-	-
Platoon blocked, %	1	-	-	1
Mov Cap-1 Maneuver	777	-	-	929
Mov Cap-2 Maneuver	-	-	-	-
Stage 1	-	-	-	-
Stage 2	-	-	-	-

Approach	EB	WB	NB	SB
HCM Control Delay, s	0.1	0.1	11.2	11.3
HCM LOS			B	B

Minor Lane/Major Mvmt	NBLn1	EBL	EBT	EBR	WBL	WBT	WBR	SBLn1
Capacity (veh/h)	580	777	-	-	929	-	-	588
HCM Lane V/C Ratio	0.002	0.007	-	-	0.013	-	-	0.027
HCM Control Delay (s)	11.2	9.7	-	-	8.9	-	-	11.3
HCM Lane LOS	B	A	-	-	A	-	-	B
HCM 95th %tile Q(veh)	0	0	-	-	0	-	-	0.1

Notes  
 ~: Volume exceeds capacity    \$: Delay exceeds 300s    +: Computation Not Defined    \*: All major volume in platoon

Pepper Square TIA  
HCM 6th TWSC

Phase 1 & P - 2028 Background - AM  
6: Alexis Drive & Belt Line

Intersection						
Int Delay, s/veh	1.9					
Movement	EBT	EBR	WBL	WBT	NBL	NBR
Lane Configurations	↑↑↑		↔ ↑↑↑		↔	
Traffic Vol, veh/h	563	5	160	1045	12	174
Future Vol, veh/h	563	5	160	1045	12	174
Conflicting Peds, #/hr	0	0	0	0	0	0
Sign Control	Free	Free	Free	Free	Stop	Stop
RT Channelized	-	None	-	None	-	Yield
Storage Length	-	-	150	-	0	0
Veh in Median Storage, #	0	-	-	0	1	-
Grade, %	0	-	-	0	0	-
Peak Hour Factor	86	86	86	86	86	86
Heavy Vehicles, %	2	2	2	2	2	2
Mvmt Flow	655	6	186	1215	14	202

Major/Minor	Major1	Major2	Minor1
Conflicting Flow All	0	0	661
Stage 1	-	-	-
Stage 2	-	-	-
Critical Hdwy	-	-	5.34
Critical Hdwy Stg 1	-	-	-
Critical Hdwy Stg 2	-	-	-
Follow-up Hdwy	-	-	3.12
Pot Cap-1 Maneuver	-	-	905
Stage 1	-	-	-
Stage 2	-	-	-
Platoon blocked, %	-	-	1
Mov Cap-1 Maneuver	-	-	905
Mov Cap-2 Maneuver	-	-	-
Stage 1	-	-	-
Stage 2	-	-	-

Approach	EB	WB	NB
HCM Control Delay, s	0	1.3	11.1
HCM LOS			B

Minor Lane/Major Mvmt	NBLn1	NBLn2	EBT	EBR	WBL	WBT
Capacity (veh/h)	488	800	-	-	905	-
HCM Lane V/C Ratio	0.029	0.253	-	-	0.206	-
HCM Control Delay (s)	12.6	11	-	-	10	-
HCM Lane LOS	B	B	-	-	B	-
HCM 95th %tile Q(veh)	0.1	1	-	-	0.8	-

Notes  
 ~: Volume exceeds capacity    \$: Delay exceeds 300s    +: Computation Not Defined    \*: All major volume in platoon



Pepper Square TIA  
HCM 6th TWSC

Phase 1 & P - 2028 Background - AM  
10: Preston & Pepper Square Driveway

Intersection													
Int Delay, s/veh	1.3												
Movement	EBL	EBT	EBR	WBL	WBT	WBR	NBL	NBT	NBR	SBL	SBT	SBR	
Lane Configurations		↔		↔			↔	↔	↔	↔	↔	↔	
Traffic Vol, veh/h	10	3	26	7	1	8	1	52	1881	19	1	16	2025
Future Vol, veh/h	10	3	26	7	1	8	1	52	1881	19	1	16	2025
Conflicting Peds, #/hr	0	0	0	0	0	0	0	0	0	0	0	0	0
Sign Control	Stop	Stop	Stop	Stop	Stop	Free	Free	Free	Free	Free	Free	Free	Free
RT Channelized	-	-	None	-	-	None	-	-	None	-	-	-	None
Storage Length	-	-	-	-	-	-	150	-	-	-	150	-	-
Veh in Median Storage, #	-	1	-	-	1	-	-	0	-	-	-	0	-
Grade, %	-	0	-	-	0	-	-	0	-	-	-	0	-
Peak Hour Factor	89	89	89	89	89	89	89	89	89	89	89	89	89
Heavy Vehicles, %	2	2	2	2	2	2	2	2	2	2	2	2	2
Mvmt Flow	11	3	29	8	1	9	1	58	2113	21	1	18	2275

Major/Minor	Minor2	Minor1	Major1	Major2									
Conflicting Flow All	3315	4603	1176	3192	4631	1067	1717	2351	0	0	1558	2134	0
Stage 1	2351	2351	-	2242	-	-	-	-	-	-	-	-	-
Stage 2	964	2252	-	950	2389	-	-	-	-	-	-	-	-
Critical Hdwy	6.44	6.54	7.14	6.44	6.54	7.14	5.64	5.34	-	-	5.64	5.34	-
Critical Hdwy Stg 1	7.34	5.54	-	7.34	5.54	-	-	-	-	-	-	-	-
Critical Hdwy Stg 2	6.74	5.54	-	6.74	5.54	-	-	-	-	-	-	-	-
Follow-up Hdwy	3.82	4.02	3.92	3.82	4.02	3.92	2.32	3.12	-	-	2.32	3.12	-
Pot Cap-1 Maneuver	26	~1	*460	*37	~1	187	*778	459	-	-	214	107	-
Stage 1	339	362	-	*26	77	-	-	-	-	-	-	-	-
Stage 2	248	77	-	*472	335	-	-	-	-	-	-	-	-
Platoon blocked, %	1	1	1	1	1	1	1	1	-	-	-	-	-
Mov Cap-1 Maneuver	19	0	*460	*27	0	187	*462	462	-	-	110	110	-
Mov Cap-2 Maneuver	111	38	-	*21	47	-	-	-	-	-	-	-	-
Stage 1	295	299	-	*23	67	-	-	-	-	-	-	-	-
Stage 2	202	67	-	*362	277	-	-	-	-	-	-	-	-

Approach	EB	WB	NB	SB
HCM Control Delay, s	32.7	154.3	0.4	0.4
HCM LOS	D	F		

Minor Lane/Major Mvmt	NBL	NBT	NBR	EBLn1	WBLn1	SBL	SBT	SBR
Capacity (veh/h)	462	-	-	173	40	110	-	-
HCM Lane V/C Ratio	0.129	-	-	0.253	0.449	0.174	-	-
HCM Control Delay (s)	13.9	-	-	32.7	154.3	44.4	-	-
HCM Lane LOS	B	-	-	D	F	E	-	-
HCM 95th %tile Q(veh)	0.4	-	-	1	1.6	0.6	-	-

Notes  
 ~: Volume exceeds capacity    \$: Delay exceeds 300s    +: Computation Not Defined    \*: All major volume in platoon

Pepper Square TIA  
HCM 6th TWSC

Phase 1 & P - 2028 Background - AM  
20: Preston & Drive 2

Intersection						
Int Delay, s/veh	0					
Movement	WBL	WBR	NBT	NBR	SBL	SBT
Lane Configurations		↔	↔	↔	↔	↔
Traffic Vol, veh/h	0	2	1866	0	0	2115
Future Vol, veh/h	0	2	1866	0	0	2115
Conflicting Peds, #/hr	0	0	0	0	0	0
Sign Control	Stop	Stop	Free	Free	Free	Free
RT Channelized	-	None	-	None	-	None
Storage Length	-	0	-	-	-	-
Veh in Median Storage, #	0	-	0	-	-	0
Grade, %	0	-	0	-	-	0
Peak Hour Factor	92	92	92	92	92	92
Heavy Vehicles, %	2	2	2	2	2	2
Mvmt Flow	0	2	2028	0	0	2299

Major/Minor	Minor1	Major1	Major2						
Conflicting Flow All	-	1014	0	0	-	-	-	-	-
Stage 1	-	-	-	-	-	-	-	-	-
Stage 2	-	-	-	-	-	-	-	-	-
Critical Hdwy	-	7.14	-	-	-	-	-	-	-
Critical Hdwy Stg 1	-	-	-	-	-	-	-	-	-
Critical Hdwy Stg 2	-	-	-	-	-	-	-	-	-
Follow-up Hdwy	-	3.92	-	-	-	-	-	-	-
Pot Cap-1 Maneuver	0	203	-	-	0	-	-	-	-
Stage 1	0	-	-	-	0	-	-	-	-
Stage 2	0	-	-	-	0	-	-	-	-
Platoon blocked, %	-	-	-	-	-	-	-	-	-
Mov Cap-1 Maneuver	-	203	-	-	-	-	-	-	-
Mov Cap-2 Maneuver	-	-	-	-	-	-	-	-	-
Stage 1	-	-	-	-	-	-	-	-	-
Stage 2	-	-	-	-	-	-	-	-	-

Approach	WB	NB	SB
HCM Control Delay, s	22.9	0	0
HCM LOS	C		

Minor Lane/Major Mvmt	NBT	NBR	WBLn1	SBT
Capacity (veh/h)	-	-	203	-
HCM Lane V/C Ratio	-	-	0.011	-
HCM Control Delay (s)	-	-	22.9	-
HCM Lane LOS	-	-	C	-
HCM 95th %tile Q(veh)	-	-	0	-

Pepper Square TIA  
HCM 6th TWSC

Phase 1 & P - 2028 Background - AM  
21: Preston & Drive 1

Intersection						
Int Delay, s/veh	0					
Movement	WBL	WBR	NBT	NBR	SBL	SBT
Lane Configurations		↑↑↑	↑↑↑			↑↑↑
Traffic Vol, veh/h	0	0	1953	0	0	2057
Future Vol, veh/h	0	0	1953	0	0	2057
Conflicting Peds, #/hr	0	0	0	0	0	0
Sign Control	Stop	Stop	Free	Free	Free	Free
RT Channelized	-	None	-	None	-	None
Storage Length	-	0	-	-	-	-
Veh in Median Storage, #	0	-	0	-	0	0
Grade, %	0	-	0	-	0	0
Peak Hour Factor	92	92	92	92	92	92
Heavy Vehicles, %	2	2	2	2	2	2
Mvmt Flow	0	0	2123	0	0	2236

Major/Minor	Minor1	Major1	Major2		
Conflicting Flow All	-	1062	0	0	-
Stage 1	-	-	-	-	-
Stage 2	-	-	-	-	-
Critical Hdwy	-	7.14	-	-	-
Critical Hdwy Stg 1	-	-	-	-	-
Critical Hdwy Stg 2	-	-	-	-	-
Follow-up Hdwy	-	3.92	-	-	-
Pot Cap-1 Maneuver	0	189	-	0	-
Stage 1	0	-	-	0	-
Stage 2	0	-	-	0	-
Platoon blocked, %	-	-	-	-	-
Mov Cap-1 Maneuver	-	189	-	-	-
Mov Cap-2 Maneuver	-	-	-	-	-
Stage 1	-	-	-	-	-
Stage 2	-	-	-	-	-

Approach	WB	NB	SB
HCM Control Delay, s	0	0	0
HCM LOS	A		

Minor Lane/Major Mvmt	NBT	NBRWBLn1	SBT
Capacity (veh/h)	-	-	-
HCM Lane V/C Ratio	-	-	-
HCM Control Delay (s)	-	0	-
HCM Lane LOS	-	A	-
HCM 95th %tile Q(veh)	-	-	-

Pepper Square TIA  
HCM 6th TWSC

Phase 1 & P - 2028 Background - AM  
22: Drive 6 & Belt Line

Intersection						
Int Delay, s/veh	0					
Movement	EBT	EBR	WBL	WBT	NBL	NBR
Lane Configurations	↑↑↑			↑↑↑		↑
Traffic Vol, veh/h	527	0	0	1091	0	0
Future Vol, veh/h	527	0	0	1091	0	0
Conflicting Peds, #/hr	0	0	0	0	0	0
Sign Control	Free	Free	Free	Free	Stop	Stop
RT Channelized	-	None	-	None	-	None
Storage Length	-	-	-	-	-	0
Veh in Median Storage, #	0	-	-	0	0	-
Grade, %	0	-	-	0	0	-
Peak Hour Factor	96	96	96	96	96	96
Heavy Vehicles, %	2	2	2	2	2	2
Mvmt Flow	549	0	0	1136	0	0

Major/Minor	Major1	Major2	Minor1		
Conflicting Flow All	0	0	-	-	275
Stage 1	-	-	-	-	-
Stage 2	-	-	-	-	-
Critical Hdwy	-	-	-	-	7.14
Critical Hdwy Stg 1	-	-	-	-	-
Critical Hdwy Stg 2	-	-	-	-	-
Follow-up Hdwy	-	-	-	-	3.92
Pot Cap-1 Maneuver	-	-	0	-	616
Stage 1	-	-	0	-	0
Stage 2	-	-	0	-	0
Platoon blocked, %	-	-	-	-	-
Mov Cap-1 Maneuver	-	-	-	-	616
Mov Cap-2 Maneuver	-	-	-	-	-
Stage 1	-	-	-	-	-
Stage 2	-	-	-	-	-

Approach	EB	WB	NB
HCM Control Delay, s	0	0	0
HCM LOS			A

Minor Lane/Major Mvmt	NBLn1	EBT	EBR	WBT
Capacity (veh/h)	-	-	-	-
HCM Lane V/C Ratio	-	-	-	-
HCM Control Delay (s)	0	-	-	-
HCM Lane LOS	A	-	-	-
HCM 95th %tile Q(veh)	-	-	-	-

Pepper Square TIA  
HCM 6th TWSC

Phase 1 & P - 2028 Background - AM  
24: Drive 5 & Belt Line

Intersection						
Int Delay, s/veh	0					
Movement	EBT	EBR	WBL	WBT	NBL	NBR
Lane Configurations	↑↑↑			↑↑↑		↑
Traffic Vol, veh/h	557	0	0	1042	0	0
Future Vol, veh/h	557	0	0	1042	0	0
Conflicting Peds, #/hr	0	0	0	0	0	0
Sign Control	Free	Free	Free	Free	Stop	Stop
RT Channelized	-	None	-	None	-	None
Storage Length	-	-	-	-	-	0
Veh in Median Storage, #	0	-	-	0	0	-
Grade, %	0	-	-	0	0	-
Peak Hour Factor	96	96	96	96	96	96
Heavy Vehicles, %	2	2	2	2	2	2
Mvmt Flow	580	0	0	1085	0	0

Major/Minor	Major1	Major2	Minor1
Conflicting Flow All	0	0	- 290
Stage 1	-	-	-
Stage 2	-	-	-
Critical Hdwy	-	-	- 7.14
Critical Hdwy Stg 1	-	-	-
Critical Hdwy Stg 2	-	-	-
Follow-up Hdwy	-	-	- 3.92
Pot Cap-1 Maneuver	-	0	- 0 603
Stage 1	-	0	- 0
Stage 2	-	0	- 0
Platoon blocked, %	-	-	-
Mov Cap-1 Maneuver	-	-	- 603
Mov Cap-2 Maneuver	-	-	-
Stage 1	-	-	-
Stage 2	-	-	-

Approach	EB	WB	NB
HCM Control Delay, s	0	0	0
HCM LOS			A

Minor Lane/Major Mvmt	NBLn1	EBT	EBR	WBT
Capacity (veh/h)	-	-	-	-
HCM Lane V/C Ratio	-	-	-	-
HCM Control Delay (s)	0	-	-	-
HCM Lane LOS	A	-	-	-
HCM 95th %tile Q(veh)	-	-	-	-

Pepper Square TIA  
HCM 6th TWSC

Phase 1 & P - 2028 Background - AM  
25: Preston & Drive 4

Intersection						
Int Delay, s/veh	0					
Movement	WBL	WBR	NBT	NBR	SBL	SBT
Lane Configurations		↑↑↑	↑↑↑			↑↑↑
Traffic Vol, veh/h	0	5	1902	3	0	2115
Future Vol, veh/h	0	5	1902	3	0	2115
Conflicting Peds, #/hr	0	0	0	0	0	0
Sign Control	Stop	Stop	Free	Free	Free	Free
RT Channelized	-	None	-	None	-	None
Storage Length	-	0	-	-	-	-
Veh in Median Storage, #	0	-	0	-	-	0
Grade, %	0	-	0	-	-	0
Peak Hour Factor	92	92	92	92	92	92
Heavy Vehicles, %	2	2	2	2	2	2
Mvmt Flow	0	5	2067	3	0	2299

Major/Minor	Minor1	Major1	Major2
Conflicting Flow All	- 1035	0	0 -
Stage 1	-	-	-
Stage 2	-	-	-
Critical Hdwy	- 7.14	-	-
Critical Hdwy Stg 1	-	-	-
Critical Hdwy Stg 2	-	-	-
Follow-up Hdwy	- 3.92	-	-
Pot Cap-1 Maneuver	0 197	-	- 0 -
Stage 1	0	-	- 0 -
Stage 2	0	-	- 0 -
Platoon blocked, %	-	-	-
Mov Cap-1 Maneuver	- 197	-	-
Mov Cap-2 Maneuver	-	-	-
Stage 1	-	-	-
Stage 2	-	-	-

Approach	WB	NB	SB
HCM Control Delay, s	23.8	0	0
HCM LOS	C		

Minor Lane/Major Mvmt	NBT	NBRWBLn1	SBT
Capacity (veh/h)	-	- 197	-
HCM Lane V/C Ratio	-	- 0.028	-
HCM Control Delay (s)	-	- 23.8	-
HCM Lane LOS	-	- C	-
HCM 95th %tile Q(veh)	-	- 0.1	-

Intersection						
Int Delay, s/veh	0					
Movement	WBL	WBR	NBT	NBR	SBL	SBT
Lane Configurations			↑ ↑ ↑			↑ ↑ ↑
Traffic Vol, veh/h	0	3	1902	0	0	2115
Future Vol, veh/h	0	3	1902	0	0	2115
Conflicting Peds, #/hr	0	0	0	0	0	0
Sign Control	Stop	Stop	Free	Free	Free	Free
RT Channelized	-	None	-	None	-	None
Storage Length	-	0	-	-	-	-
Veh in Median Storage, #	0	-	0	-	-	0
Grade, %	0	-	0	-	-	0
Peak Hour Factor	92	92	92	92	92	92
Heavy Vehicles, %	2	2	2	2	2	2
Mvmt Flow	0	3	2067	0	0	2299

Major/Minor	Minor1	Major1	Major2		
Conflicting Flow All	-	1034	0	0	-
Stage 1	-	-	-	-	-
Stage 2	-	-	-	-	-
Critical Hdwy	-	7.14	-	-	-
Critical Hdwy Stg 1	-	-	-	-	-
Critical Hdwy Stg 2	-	-	-	-	-
Follow-up Hdwy	-	3.92	-	-	-
Pot Cap-1 Maneuver	0	197	-	-	0
Stage 1	0	-	-	-	0
Stage 2	0	-	-	-	0
Platoon blocked, %	-	-	-	-	-
Mov Cap-1 Maneuver	-	197	-	-	-
Mov Cap-2 Maneuver	-	-	-	-	-
Stage 1	-	-	-	-	-
Stage 2	-	-	-	-	-

Approach	WB	NB	SB
HCM Control Delay, s	23.6	0	0
HCM LOS	C		

Minor Lane/Major Mvmt	NBT	NBRWBLn1	SBT
Capacity (veh/h)	-	-	197
HCM Lane V/C Ratio	-	-	0.017
HCM Control Delay (s)	-	-	23.6
HCM Lane LOS	-	-	C
HCM 95th %tile Q(veh)	-	-	0.1

Pepper Square TIA  
Lanes, Volumes, Timings

Phase 1 & P - 2028 Background - PM  
4: Berry Trail & Belt Line

Lane Group	EBL	EBT	EBR	WBL	WBT	WBR	NBL	NBT	NBR	SBL	SBT	SBR
Lane Configurations	↔	↕↕↕		↔	↕↕↕		↔	↕		↔	↕	
Traffic Volume (vph)	40	1196	14	19	872	32	3	9	4	27	6	34
Future Volume (vph)	40	1196	14	19	872	32	3	9	4	27	6	34
Ideal Flow (vphpl)	1900	1900	1900	1900	1900	1900	1900	1900	1900	1900	1900	1900
Storage Length (ft)	150		0	150		0	0		0	0		0
Storage Lanes	1		0	1		0	1		0	1		0
Taper Length (ft)	25			25			25			25		
Lane Util. Factor	1.00	0.91	0.91	1.00	0.91	0.91	1.00	1.00	1.00	1.00	1.00	1.00
Frt		0.998			0.995			0.957			0.871	
Fit Protected	0.950			0.950			0.950			0.950		
Satd. Flow (prot)	1770	5075	0	1770	5060	0	1770	1783	0	1770	1622	0
Fit Permitted	0.279			0.193			0.730					
Satd. Flow (perm)	520	5075	0	360	5060	0	1360	1783	0	1863	1622	0
Right Turn on Red		Yes			Yes			Yes			Yes	
Satd. Flow (RTOR)		2			6			4			36	
Link Speed (mph)	42			42			30			30		
Link Distance (ft)	234			493			277			236		
Travel Time (s)	3.8			8.0			6.3			5.4		
Peak Hour Factor	0.94	0.94	0.94	0.94	0.94	0.94	0.94	0.94	0.94	0.94	0.94	0.94
Adj. Flow (vph)	43	1272	15	20	928	34	3	10	4	29	6	36
Shared Lane Traffic (%)												
Lane Group Flow (vph)	43	1287	0	20	962	0	3	14	0	29	42	0
Enter Blocked Intersection	No	No	No	No	No	No	No	No	No	No	No	No
Lane Alignment	Left	Left	Right	Left	Left	Right	Left	Left	Right	Left	Left	Right
Median Width(ft)	12			12			12			12		
Link Offset(ft)	0			0			0			0		
Crosswalk Width(ft)	16			16			16			16		
Two way Left Turn Lane												
Headway Factor	1.00	1.00	1.00	1.00	1.00	1.00	1.00	1.00	1.00	1.00	1.00	1.00
Turning Speed (mph)	15		9	15		9	15		9	15		9
Number of Detectors	1	2		1	2		1	2		1	2	
Detector Template	Left	Thru		Left	Thru		Left	Thru		Left	Thru	
Leading Detector (ft)	20	100		20	100		20	100		20	100	
Trailing Detector (ft)	0	0		0	0		0	0		0	0	
Detector 1 Position(ft)	0	0		0	0		0	0		0	0	
Detector 1 Size(ft)	20	6		20	6		20	6		20	6	
Detector 1 Type	CI+Ex	CI+Ex		CI+Ex	CI+Ex		CI+Ex	CI+Ex		CI+Ex	CI+Ex	
Detector 1 Channel												
Detector 1 Extend (s)	0.0	0.0		0.0	0.0		0.0	0.0		0.0	0.0	
Detector 1 Queue (s)	0.0	0.0		0.0	0.0		0.0	0.0		0.0	0.0	
Detector 1 Delay (s)	0.0	0.0		0.0	0.0		0.0	0.0		0.0	0.0	
Detector 2 Position(ft)		94			94			94			94	
Detector 2 Size(ft)		6			6			6			6	
Detector 2 Type		CI+Ex			CI+Ex			CI+Ex			CI+Ex	
Detector 2 Channel												
Detector 2 Extend (s)		0.0			0.0			0.0			0.0	
Turn Type	D,P+P	NA		D,P+P	NA		D,P+P	NA		D,P+P	NA	
Protected Phases	3	8		7	4		1	6		5	2	
Permitted Phases	4			8			2			6		

Pepper Square TIA  
Lanes, Volumes, Timings

Phase 1 & P - 2028 Background - PM  
4: Berry Trail & Belt Line

Lane Group	EBL	EBT	EBR	WBL	WBT	WBR	NBL	NBT	NBR	SBL	SBT	SBR
Detector Phase	3	8		7	4		1	6		5	2	
Switch Phase												
Minimum Initial (s)	4.0	4.0		4.0	4.0		4.0	4.0		4.0	4.0	
Minimum Split (s)	10.0	24.0		10.0	24.0		10.0	31.0		10.0	31.0	
Total Split (s)	15.0	99.0		15.0	99.0		15.0	31.0		15.0	31.0	
Total Split (%)	9.4%	61.9%		9.4%	61.9%		9.4%	19.4%		9.4%	19.4%	
Maximum Green (s)	9.0	93.0		9.0	93.0		9.0	25.0		9.0	25.0	
Yellow Time (s)	4.0	4.0		4.0	4.0		4.0	4.0		4.0	4.0	
All-Red Time (s)	2.0	2.0		2.0	2.0		2.0	2.0		2.0	2.0	
Lost Time Adjust (s)	0.0	0.0		0.0	0.0		0.0	0.0		0.0	0.0	
Total Lost Time (s)	6.0	6.0		6.0	6.0		6.0	6.0		6.0	6.0	
Lead/Lag	Lead	Lag		Lead	Lag		Lead	Lag		Lead	Lag	
Lead-Lag Optimize?	Yes	Yes		Yes	Yes		Yes	Yes		Yes	Yes	
Vehicle Extension (s)	1.0	1.0		1.0	1.0		1.0	1.0		1.0	1.0	
Recall Mode	None	C-Max		None	C-Max		None	None		None	None	
Walk Time (s)		4.0			4.0			4.0			4.0	
Flash Dont Walk (s)		14.0			14.0			21.0			21.0	
Pedestrian Calls (#/hr)		0			0			0			0	
Act Effct Green (s)	134.4	134.3		135.6	132.1		9.6	4.8		8.4	8.7	
Actuated g/C Ratio	0.84	0.84		0.85	0.83		0.06	0.03		0.05	0.05	
v/c Ratio	0.09	0.30		0.06	0.23		0.03	0.25		0.31	0.34	
Control Delay	1.7	1.8		0.9	1.2		64.0	70.3		75.4	31.8	
Queue Delay	0.0	0.0		0.0	0.0		0.0	0.0		0.0	0.0	
Total Delay	1.7	1.8		0.9	1.2		64.0	70.3		75.4	31.8	
LOS	A	A		A	A		E	E		E	C	
Approach Delay		1.8			1.1			69.2			49.7	
Approach LOS		A			A			E			D	
Queue Length 50th (ft)	3	35		0	12		3	10		30	6	
Queue Length 95th (ft)	m5	53		2	49		14	37		61	49	
Internal Link Dist (ft)		154			413			197			156	
Turn Bay Length (ft)	150			150								
Base Capacity (vph)	519	4261		391	4178		132	281		126	283	
Starvation Cap Reductn	0	0		0	0		0	0		0	0	
Spillback Cap Reductn	0	0		0	0		0	0		0	0	
Storage Cap Reductn	0	0		0	0		0	0		0	0	
Reduced v/c Ratio	0.08	0.30		0.05	0.23		0.02	0.05		0.23	0.15	

Intersection Summary

Area Type:	Other
Cycle Length:	160
Actuated Cycle Length:	160
Offset:	153 (96%), Referenced to phase 4:EBWB and 8:EBWB, Start of Yellow
Natural Cycle:	75
Control Type:	Actuated-Coordinated
Maximum v/c Ratio:	0.34
Intersection Signal Delay:	3.4
Intersection LOS:	A
Intersection Capacity Utilization:	49.9%
ICU Level of Service:	A
Analysis Period (min):	15
m	Volume for 95th percentile queue is metered by upstream signal.

Pepper Square TIA  
Lanes, Volumes, Timings

Phase 1 & P - 2028 Background - PM  
4: Berry Trail & Belt Line

Splits and Phases: 4: Berry Trail & Belt Line

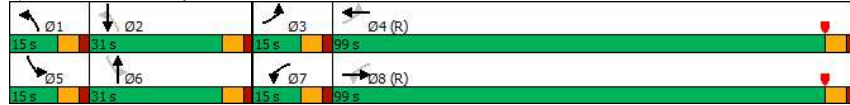

Pepper Square TIA  
Lanes, Volumes, Timings

Phase 1 & P - 2028 Background - PM  
1335: Meadow Creek & Belt Line

	EBL	EBT	EBR	WBL	WBT	WBR	NBL	NBT	NBR	SBL	SBT	SBR
Lane Configurations	↑↑↑↑											
Traffic Volume (vph)	89	1369	45	7	1066	19	19	11	9	12	5	61
Future Volume (vph)	89	1369	45	7	1066	19	19	11	9	12	5	61
Ideal Flow (vphpl)	1900	1900	1900	1900	1900	1900	1900	1900	1900	1900	1900	1900
Storage Length (ft)	150		0	150		0	0		0	0		0
Storage Lanes	1		0	1		0	0		0	0		0
Taper Length (ft)	25			25			25			25		
Lane Util. Factor	1.00	0.91	0.91	1.00	0.91	0.91	1.00	1.00	1.00	1.00	1.00	1.00
Frt		0.995			0.997			0.970				0.895
Fit Protected	0.950			0.950				0.976				0.992
Satd. Flow (prot)	1770	5060	0	1770	5070	0	0	1763	0	0	1654	0
Fit Permitted	0.234			0.160				0.517				0.945
Satd. Flow (perm)	436	5060	0	298	5070	0	0	934	0	0	1575	0
Right Turn on Red			Yes			Yes			Yes			Yes
Satd. Flow (RTOR)		6			3			9				64
Link Speed (mph)	42			42			30					30
Link Distance (ft)		1673			2404		392					423
Travel Time (s)		27.2			39.0		8.9					9.6
Peak Hour Factor	0.95	0.95	0.95	0.95	0.95	0.95	0.95	0.95	0.95	0.95	0.95	0.95
Adj. Flow (vph)	94	1441	47	7	1122	20	20	12	9	13	5	64
Shared Lane Traffic (%)												
Lane Group Flow (vph)	94	1488	0	7	1142	0	0	41	0	0	82	0
Enter Blocked Intersection	No	No	No	No	No	No	No	No	No	No	No	No
Lane Alignment	Left	Left	Right	Left	Left	Right	Left	Left	Right	Left	Left	Right
Median Width(ft)	12			12			0					0
Link Offset(ft)	0			0			0					0
Crosswalk Width(ft)	16			16			16					16
Two way Left Turn Lane												
Headway Factor	1.00	1.00	1.00	1.00	1.00	1.00	1.00	1.00	1.00	1.00	1.00	1.00
Turning Speed (mph)	15		9	15		9	15		9	15		9
Number of Detectors	1	1		1	1		1	1		1		1
Detector Template												
Leading Detector (ft)	50	50		50	50		50	50		50		50
Trailing Detector (ft)	0	0		0	0		0	0		0		0
Detector 1 Position(ft)	0	0		0	0		0	0		0		0
Detector 1 Size(ft)	50	50		50	50		50	50		50		50
Detector 1 Type	CI+Ex	CI+Ex		CI+Ex	CI+Ex		CI+Ex	CI+Ex		CI+Ex		CI+Ex
Detector 1 Channel												
Detector 1 Extend (s)	0.0	0.0		0.0	0.0		0.0	0.0		0.0		0.0
Detector 1 Queue (s)	0.0	0.0		0.0	0.0		0.0	0.0		0.0		0.0
Detector 1 Delay (s)	0.0	0.0		0.0	0.0		0.0	0.0		0.0		0.0
Turn Type	Perm	NA		Perm	NA		Perm	NA		Perm		NA
Protected Phases		6			2			4				4
Permitted Phases	6			2			4			4		
Detector Phase	6	6		2	2		4	4		4		4
Switch Phase												
Minimum Initial (s)	12.0	12.0		12.0	12.0		6.0	6.0		6.0		6.0
Minimum Split (s)	17.0	17.0		17.0	17.0		23.5	23.5		23.5		23.5
Total Split (s)	110.0	110.0		110.0	110.0		50.0	50.0		50.0		50.0

Pepper Square TIA  
Lanes, Volumes, Timings

Phase 1 & P - 2028 Background - PM  
1335: Meadow Creek & Belt Line

Lane Group	EBL	EBT	EBR	WBL	WBT	WBR	NBL	NBT	NBR	SBL	SBT	SBR
Total Split (%)	68.8%	68.8%		68.8%	68.8%		31.3%	31.3%		31.3%	31.3%	
Maximum Green (s)	105.0	105.0		105.0	105.0		44.5	44.5		44.5	44.5	
Yellow Time (s)	4.0	4.0		4.0	4.0		3.7	3.7		3.7	3.7	
All-Red Time (s)	1.0	1.0		1.0	1.0		1.8	1.8		1.8	1.8	
Lost Time Adjust (s)	-1.0	-1.0		-1.0	-1.0		-1.5	-1.5		-1.5	-1.5	
Total Lost Time (s)	4.0	4.0		4.0	4.0		4.0	4.0		4.0	4.0	
Lead/Lag												
Lead-Lag Optimize?												
Vehicle Extension (s)	2.0	2.0		2.0	2.0		1.8	1.8		1.8	1.8	
Recall Mode	Min	Min		C-Max	C-Max		None	None		None	None	
Walk Time (s)	4.0	4.0		4.0	4.0		4.0	4.0		4.0	4.0	
Flash Dont Walk (s)	8.0	8.0		8.0	8.0		14.0	14.0		14.0	14.0	
Pedestrian Calls (#/hr)	0	0		0	0		0	0		0	0	
Act Effect Green (s)	142.4	142.4		142.4	142.4		9.6	9.6		9.6	9.6	
Actuated g/C Ratio	0.89	0.89		0.89	0.89		0.06	0.06		0.06	0.06	
v/c Ratio	0.24	0.33		0.03	0.25		0.64	0.64		0.53	0.53	
Control Delay	2.3	0.9		0.1	0.1		99.9	99.9		35.5	35.5	
Queue Delay	0.0	0.0		0.0	0.0		0.0	0.0		0.0	0.0	
Total Delay	2.3	0.9		0.1	0.1		99.9	99.9		35.5	35.5	
LOS	A	A		A	A		F	F		D	D	
Approach Delay		1.0			0.1		99.9	99.9		35.5	35.5	
Approach LOS		A			A		F	F		D	D	
Queue Length 50th (ft)	3	18		0	4		33	33		18	18	
Queue Length 95th (ft)	19	71		m0	m5		78	78		76	76	
Internal Link Dist (ft)		1593			2324		312	312		343	343	
Turn Bay Length (ft)	150			150								
Base Capacity (vph)	387	4504		265	4513		274	274		498	498	
Starvation Cap Reductn	0	0		0	0		0	0		0	0	
Spillback Cap Reductn	0	0		0	0		0	0		0	0	
Storage Cap Reductn	0	0		0	0		0	0		0	0	
Reduced v/c Ratio	0.24	0.33		0.03	0.25		0.15	0.15		0.16	0.16	

Intersection Summary

Area Type: Other  
 Cycle Length: 160  
 Actuated Cycle Length: 160  
 Offset: 73 (46%), Referenced to phase 2:WBTL, Start of Yellow  
 Natural Cycle: 60  
 Control Type: Actuated-Coordinated  
 Maximum v/c Ratio: 0.64  
 Intersection Signal Delay: 3.1  
 Intersection LOS: A  
 Intersection Capacity Utilization 52.8%  
 ICU Level of Service A  
 Analysis Period (min) 15  
 m Volume for 95th percentile queue is metered by upstream signal.

Splits and Phases: 1335: Meadow Creek & Belt Line



Pepper Square TIA  
Lanes, Volumes, Timings

Phase 1 & P - 2028 Background - PM  
1365: Preston & Arapaho

Lane Group	EBU	EBL	EBT	EBR	WBL	WBT	WBR	NBU	NBL	NBT	NBR	SBU
Lane Configurations		↑↑	↑↑↑		↑↑	↑↑↑			↑↑	↑↑↑		
Traffic Volume (vph)	1	276	955	197	174	595	151	3	196	1794	209	5
Future Volume (vph)	1	276	955	197	174	595	151	3	196	1794	209	5
Ideal Flow (vphpl)	1900	1900	1900	1900	1900	1900	1900	1900	1900	1900	1900	1900
Storage Length (ft)		150		0	150		0		300		0	
Storage Lanes		2		0	2		0		2		0	
Taper Length (ft)		25			25				25			
Lane Util. Factor	0.91	0.97	0.91	0.91	0.97	0.91	0.91	0.91	0.97	0.91	0.91	0.91
Frt			0.974			0.970					0.984	
Fit Protected		0.950			0.950				0.950			
Satd. Flow (prot)	0	3433	4953	0	3433	4933	0	0	3433	5004	0	0
Fit Permitted		0.950			0.950				0.950			
Satd. Flow (perm)	0	3433	4953	0	3433	4933	0	0	3433	5004	0	0
Right Turn on Red				Yes			Yes				Yes	
Satd. Flow (RTOR)			28			34					16	
Link Speed (mph)			42			42					42	
Link Distance (ft)			1672			1942					3054	
Travel Time (s)			27.1			31.5					49.6	
Peak Hour Factor	0.93	0.93	0.93	0.93	0.93	0.93	0.93	0.93	0.93	0.93	0.93	0.93
Adj. Flow (vph)	1	297	1027	212	187	640	162	3	211	1929	225	5
Shared Lane Traffic (%)												
Lane Group Flow (vph)	0	298	1239	0	187	802	0	0	214	2154	0	0
Enter Blocked Intersection	No	No	No	No	No	No	No	No	No	No	No	No
Lane Alignment	R NA	Left	Left	Right	Left	Left	Right	R NA	Left	Left	Right	R NA
Median Width(ft)			24			24					24	
Link Offset(ft)			0			0					0	
Crosswalk Width(ft)			16			16					16	
Two way Left Turn Lane												
Headway Factor	1.00	1.00	1.00	1.00	1.00	1.00	1.00	1.00	1.00	1.00	1.00	1.00
Turning Speed (mph)	9	15		9	15		9	15		9	15	9
Number of Detectors	1	1	1		1	1		1	1	1	1	1
Detector Template												
Leading Detector (ft)	50	50	50		50	50		50	50	50	50	50
Trailing Detector (ft)	0	0	0		0	0		0	0	0	0	0
Detector 1 Position(ft)	0	0	0		0	0		0	0	0	0	0
Detector 1 Size(ft)	50	50	50		50	50		50	50	50	50	50
Detector 1 Type	CI+Ex	CI+Ex	CI+Ex		CI+Ex	CI+Ex		CI+Ex	CI+Ex	CI+Ex	CI+Ex	CI+Ex
Detector 1 Channel												
Detector 1 Extend (s)	0.0	0.0	0.0		0.0	0.0		0.0	0.0	0.0	0.0	0.0
Detector 1 Queue (s)	0.0	0.0	0.0		0.0	0.0		0.0	0.0	0.0	0.0	0.0
Detector 1 Delay (s)	0.0	0.0	0.0		0.0	0.0		0.0	0.0	0.0	0.0	0.0
Turn Type	Prot	Prot	NA		Prot	NA		Prot	Prot	NA	Prot	Prot
Protected Phases	3	3	8		7	4		1	1	6		5
Permitted Phases												
Detector Phase	3	3	8		7	4		1	1	6		5
Switch Phase												
Minimum Initial (s)	3.0	3.0	18.0		3.0	18.0		3.0	3.0	18.0		3.0
Minimum Split (s)	10.0	10.0	36.7		21.0	36.3		10.0	10.0	35.7		10.0
Total Split (s)	30.0	30.0	53.0		13.0	36.0		24.0	24.0	76.0		18.0

Pepper Square TIA  
Lanes, Volumes, Timings

Phase 1 & P - 2028 Background - PM  
1365: Preston & Arapaho

Lane Group	SBL	SBT	SBR
Lane Configurations	↑↑	↑↑↑	
Traffic Volume (vph)	215	1405	187
Future Volume (vph)	215	1405	187
Ideal Flow (vphpl)	1900	1900	1900
Storage Length (ft)	250		0
Storage Lanes	2		0
Taper Length (ft)	25		
Lane Util. Factor	0.97	0.91	0.91
Frt		0.982	
Fit Protected	0.950		
Satd. Flow (prot)	3433	4994	0
Fit Permitted	0.950		
Satd. Flow (perm)	3433	4994	0
Right Turn on Red			Yes
Satd. Flow (RTOR)		18	
Link Speed (mph)		48	
Link Distance (ft)		5087	
Travel Time (s)		72.3	
Peak Hour Factor	0.93	0.93	0.93
Adj. Flow (vph)	231	1511	201
Shared Lane Traffic (%)			
Lane Group Flow (vph)	236	1712	0
Enter Blocked Intersection	No	No	No
Lane Alignment	Left	Left	Right
Median Width(ft)		24	
Link Offset(ft)		0	
Crosswalk Width(ft)		16	
Two way Left Turn Lane			
Headway Factor	1.00	1.00	1.00
Turning Speed (mph)	15		9
Number of Detectors	1	1	
Detector Template			
Leading Detector (ft)	50	50	
Trailing Detector (ft)	0	0	
Detector 1 Position(ft)	0	0	
Detector 1 Size(ft)	50	50	
Detector 1 Type	CI+Ex	CI+Ex	
Detector 1 Channel			
Detector 1 Extend (s)	0.0	0.0	
Detector 1 Queue (s)	0.0	0.0	
Detector 1 Delay (s)	0.0	0.0	
Turn Type	Prot	NA	
Protected Phases	5	2	
Permitted Phases			
Detector Phase	5	2	
Switch Phase			
Minimum Initial (s)	3.0	18.0	
Minimum Split (s)	10.0	37.7	
Total Split (s)	18.0	70.0	

Pepper Square TIA  
Lanes, Volumes, Timings

Phase 1 & P - 2028 Background - PM  
1365: Preston & Arapaho

Lane Group	EBU	EBL	EBT	EBR	WBL	WBT	WBR	NBU	NBL	NBT	NBR	SBU
Total Split (%)	18.8%	18.8%	33.1%		8.1%	22.5%		15.0%	15.0%	47.5%		11.3%
Maximum Green (s)	24.5	24.5	47.7		7.5	30.7		18.5	18.5	70.3		12.5
Yellow Time (s)	3.0	3.0	4.3		3.0	4.3		3.0	3.0	4.7		3.0
All-Red Time (s)	2.5	2.5	1.0		2.5	1.0		2.5	2.5	1.0		2.5
Lost Time Adjust (s)		-1.0	-1.4		-1.0	-1.0			-1.0	-1.7		
Total Lost Time (s)		4.5	3.9		4.5	4.3			4.5	4.0		
Lead/Lag	Lead	Lead	Lead		Lag	Lag		Lead	Lead	Lead		Lag
Lead-Lag Optimize?	Yes	Yes	Yes		Yes	Yes		Yes	Yes	Yes		Yes
Vehicle Extension (s)	0.8	0.8	2.5		0.8	1.8		1.5	1.5	1.7		1.5
Recall Mode	None	None	Max		None	None		None	None	Max		None
Walk Time (s)			4.0			4.0				4.0		
Flash Dont Walk (s)			27.0			27.0				26.0		
Pedestrian Calls (#/hr)			0			0				0		
Act Effect Green (s)		18.1	49.1		8.5	39.1			14.8	72.0		
Actuated g/C Ratio		0.11	0.31		0.05	0.24			0.09	0.45		
v/c Ratio		0.77	0.81		1.03	0.65			0.67	0.95		
Control Delay		81.3	54.0		137.3	50.3			96.7	27.6		
Queue Delay		0.0	0.0		0.0	0.0			0.0	0.0		
Total Delay		81.3	54.0		137.3	50.3			96.7	27.6		
LOS		F	D		F	D			F	C		
Approach Delay			59.3			66.8				33.8		
Approach LOS			E			E				C		
Queue Length 50th (ft)		158	430		-107	243			104	188		
Queue Length 95th (ft)		206	491		#194	274			m118	m194		
Internal Link Dist (ft)			1592			1862				2974		
Turn Bay Length (ft)		150			150				300			
Base Capacity (vph)		547	1539		182	1231			418	2260		
Starvation Cap Reductn		0	0		0	0			0	0		
Spillback Cap Reductn		0	0		0	0			0	0		
Storage Cap Reductn		0	0		0	0			0	0		
Reduced v/c Ratio		0.54	0.81		1.03	0.65			0.51	0.95		
<b>Intersection Summary</b>												
Area Type:	Other											
Cycle Length:	160											
Actuated Cycle Length:	160											
Offset:	120 (75%), Referenced to phase 2:SBT, Start of Yellow											
Natural Cycle:	140											
Control Type:	Actuated-Coordinated											
Maximum v/c Ratio:	1.03											
Intersection Signal Delay:	46.2						Intersection LOS: D					
Intersection Capacity Utilization:	87.6%						ICU Level of Service E					
Analysis Period (min)	15											
~	Volume exceeds capacity, queue is theoretically infinite. Queue shown is maximum after two cycles.											
#	95th percentile volume exceeds capacity, queue may be longer. Queue shown is maximum after two cycles.											
m	Volume for 95th percentile queue is metered by upstream signal.											



Pepper Square TIA  
Lanes, Volumes, Timings

Phase 1 & P - 2028 Background - PM  
1365: Preston & Arapaho

Splits and Phases: 1365: Preston & Arapaho

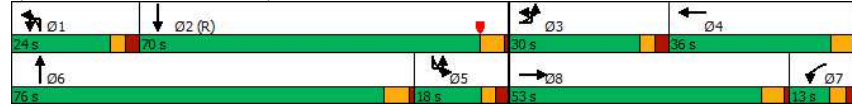

Pepper Square TIA  
Lanes, Volumes, Timings

Phase 1 & P - 2028 Background - PM  
1365: Preston & Arapaho

Lane Group	SBL	SBT	SBR
Total Split (%)	11.3%	43.8%	
Maximum Green (s)	12.5	64.3	
Yellow Time (s)	3.0	4.7	
All-Red Time (s)	2.5	1.0	
Lost Time Adjust (s)	-1.0	-1.7	
Total Lost Time (s)	4.5	4.0	
Lead/Lag	Lag	Lag	
Lead-Lag Optimize?	Yes	Yes	
Vehicle Extension (s)	1.5	1.5	
Recall Mode	None	C-Max	
Walk Time (s)		4.0	
Flash Dont Walk (s)		28.0	
Pedestrian Calls (#/hr)		0	
Act Effect Green (s)	13.5	70.7	
Actuated g/C Ratio	0.08	0.44	
v/c Ratio	0.82	0.77	
Control Delay	80.0	35.1	
Queue Delay	0.0	0.0	
Total Delay	80.0	35.1	
LOS	E	D	
Approach Delay		40.5	
Approach LOS		D	
Queue Length 50th (ft)	128	556	
Queue Length 95th (ft)	m154	618	
Internal Link Dist (ft)		5007	
Turn Bay Length (ft)	250		
Base Capacity (vph)	289	2215	
Starvation Cap Reductn	0	0	
Spillback Cap Reductn	0	0	
Storage Cap Reductn	0	0	
Reduced v/c Ratio	0.82	0.77	
<b>Intersection Summary</b>			

Pepper Square TIA  
Lanes, Volumes, Timings

Phase 1 & P - 2028 Background - PM  
1367: Preston & Belt Line



Lane Group	EBU	EBL	EBT	EBR	WBU	WBL	WBT	WBR	NBL	NBT	NBR	SBU
Lane Configurations		↔	↕	↔		↔	↕	↔	↔	↕	↔	
Traffic Volume (vph)	46	365	1020	386	1	92	658	112	484	1892	62	2
Future Volume (vph)	46	365	1020	386	1	92	658	112	484	1892	62	2
Ideal Flow (vphpl)	1900	1900	1900	1900	1900	1900	1900	1900	1900	1900	1900	1900
Storage Length (ft)		150		150		200		0	250		0	
Storage Lanes		2		1		1		0	2		0	
Taper Length (ft)		25				25			25			
Lane Util. Factor	0.91	0.97	0.91	1.00	0.91	1.00	0.91	0.91	0.97	0.91	0.91	0.91
Fr			0.850				0.978			0.995		
Fit Protected		0.950				0.950			0.950			
Satd. Flow (prot)	0	3433	5085	1583	0	1770	4973	0	3433	5060	0	0
Fit Permitted		0.950				0.950			0.950			
Satd. Flow (perm)	0	3433	5085	1583	0	1770	4973	0	3433	5060	0	0
Right Turn on Red				Yes			Yes			Yes		
Satd. Flow (RTOR)				228			17			4		
Link Speed (mph)			42				42			42		
Link Distance (ft)			925				394			261		
Travel Time (s)			15.0				6.4			4.2		
Peak Hour Factor	0.96	0.96	0.96	0.96	0.96	0.96	0.96	0.96	0.96	0.96	0.96	0.96
Adj. Flow (vph)	48	380	1063	402	1	96	685	117	504	1971	65	2
Shared Lane Traffic (%)												
Lane Group Flow (vph)	0	428	1063	402	0	97	802	0	504	2036	0	0
Enter Blocked Intersection	No	No	No	No	No	No	No	No	No	No	No	No
Lane Alignment	R NA	Left	Left	Right	R NA	Left	Right	Left	Left	Right	R NA	
Median Width(ft)			24				24			24		
Link Offset(ft)			0				0			0		
Crosswalk Width(ft)			16				16			16		
Two way Left Turn Lane												
Headway Factor	1.00	1.00	1.00	1.00	1.00	1.00	1.00	1.00	1.00	1.00	1.00	1.00
Turning Speed (mph)	9	15		9	9	15		9	15		9	9
Number of Detectors	1	1	1	1	1	1	1	1	1	1	1	1
Detector Template												
Leading Detector (ft)	50	50	50	50	50	50	50	50	50	50	50	50
Trailing Detector (ft)	0	0	0	0	0	0	0	0	0	0	0	0
Detector 1 Position(ft)	0	0	0	0	0	0	0	0	0	0	0	0
Detector 1 Size(ft)	50	50	50	50	50	50	50	50	50	50	50	50
Detector 1 Type	CI+Ex	CI+Ex	CI+Ex	CI+Ex	CI+Ex	CI+Ex	CI+Ex	CI+Ex	CI+Ex	CI+Ex	CI+Ex	CI+Ex
Detector 1 Channel												
Detector 1 Extend (s)	0.0	0.0	0.0	0.0	0.0	0.0	0.0	0.0	0.0	0.0	0.0	0.0
Detector 1 Queue (s)	0.0	0.0	0.0	0.0	0.0	0.0	0.0	0.0	0.0	0.0	0.0	0.0
Detector 1 Delay (s)	0.0	0.0	0.0	0.0	0.0	0.0	0.0	0.0	0.0	0.0	0.0	0.0
Turn Type	Prot	Prot	NA	Perm	Prot	Prot	NA	Prot	NA	Prot	NA	Prot
Protected Phases	3 13	3 13	8		17	17	4		1 11	6		5
Permitted Phases				8								
Detector Phase	3 13	3 13	8	8	17	17	4		1 11	6		5
Switch Phase												
Minimum Initial (s)			18.0	18.0	3.0	3.0	18.0		18.0			3.0
Minimum Split (s)			32.5	32.5	8.0	8.0	32.5		33.0			11.0
Total Split (s)			50.0	50.0	14.0	14.0	27.0		77.0			19.0

Pepper Square TIA  
Lanes, Volumes, Timings

Phase 1 & P - 2028 Background - PM  
1367: Preston & Belt Line



Lane Group	SBL	SBT	SBR	Ø1	Ø3	Ø11	Ø13
Lane Configurations	↔	↕	↔				
Traffic Volume (vph)	145	1426	267				
Future Volume (vph)	145	1426	267				
Ideal Flow (vphpl)	1900	1900	1900				
Storage Length (ft)	200		300				
Storage Lanes	1		1				
Taper Length (ft)	25						
Lane Util. Factor	1.00	0.91	1.00				
Fr			0.850				
Fit Protected	0.950						
Satd. Flow (prot)	1770	5085	1583				
Fit Permitted	0.950						
Satd. Flow (perm)	1770	5085	1583				
Right Turn on Red			Yes				
Satd. Flow (RTOR)			229				
Link Speed (mph)			40				
Link Distance (ft)			3054				
Travel Time (s)			52.1				
Peak Hour Factor	0.96	0.96	0.96				
Adj. Flow (vph)	151	1485	278				
Shared Lane Traffic (%)							
Lane Group Flow (vph)	153	1485	278				
Enter Blocked Intersection	No	No	No				
Lane Alignment	Left	Left	Right				
Median Width(ft)			24				
Link Offset(ft)			0				
Crosswalk Width(ft)			16				
Two way Left Turn Lane							
Headway Factor	1.00	1.00	1.00				
Turning Speed (mph)	15		9				
Number of Detectors	1	1	1				
Detector Template							
Leading Detector (ft)	50	50	50				
Trailing Detector (ft)	0	0	0				
Detector 1 Position(ft)	0	0	0				
Detector 1 Size(ft)	50	50	50				
Detector 1 Type	CI+Ex	CI+Ex	CI+Ex				
Detector 1 Channel							
Detector 1 Extend (s)	0.0	0.0	0.0				
Detector 1 Queue (s)	0.0	0.0	0.0				
Detector 1 Delay (s)	0.0	0.0	0.0				
Turn Type	Prot	NA	Perm				
Protected Phases	5	2		1	3	11	13
Permitted Phases			2				
Detector Phase	5	2	2				
Switch Phase							
Minimum Initial (s)	3.0	18.0	18.0	3.0	3.0	3.0	3.0
Minimum Split (s)	11.0	33.0	33.0	8.0	11.0	8.0	11.0
Total Split (s)	19.0	60.0	60.0	16.0	20.0	20.0	17.0

Pepper Square TIA  
Lanes, Volumes, Timings

Phase 1 & P - 2028 Background - PM  
1367: Preston & Belt Line

Lane Group	EBU	EBL	EBT	EBR	WBU	WBL	WBT	WBR	NBL	NBT	NBR	SBU
Total Split (%)			31.3%	31.3%	8.8%	8.8%	16.9%			48.1%		11.9%
Maximum Green (s)			44.5	44.5	9.0	9.0	21.5			71.0		14.0
Yellow Time (s)			4.0	4.0	3.0	3.0	4.0			4.4		3.0
All-Red Time (s)			1.5	1.5	2.0	2.0	1.5			1.6		2.0
Lost Time Adjust (s)			-1.5	-1.5		-1.0	-1.5			-1.7		
Total Lost Time (s)			4.0	4.0		4.0	4.0			4.3		
Lead/Lag										Lag		Lead
Lead-Lag Optimize?										Yes		Yes
Vehicle Extension (s)			1.3	1.3	3.0	3.0	1.3			2.0		1.5
Recall Mode			Min	Min	None	None	Min			C-Max		None
Walk Time (s)			7.0	7.0			7.0			7.0		
Flash Dont Walk (s)			20.0	20.0			20.0			20.0		
Pedestrian Calls (#/hr)			0	0			0			0		
Act Effect Green (s)			27.5	39.6	39.6		15.2	23.3		30.8		73.4
Actuated g/C Ratio			0.17	0.25	0.25		0.10	0.15		0.19		0.46
v/c Ratio			0.73	0.85	0.71		0.58	1.09		0.76		0.88
Control Delay			59.2	68.4	37.0		58.9	87.7		46.7		22.6
Queue Delay			0.0	0.0	0.0		0.0	0.0		0.0		1.5
Total Delay			59.2	68.4	37.0		58.9	87.7		46.7		24.1
LOS			E	E	D		E	F		D		C
Approach Delay			59.6				84.6			28.6		
Approach LOS			E				F			C		
Queue Length 50th (ft)			180	409	198		106	-328		212		678
Queue Length 95th (ft)			252	450	347		#230	#423		#283		620
Internal Link Dist (ft)			845				314			181		
Turn Bay Length (ft)			150		150		200			250		
Base Capacity (vph)			622	1461	617		168	737		660		2322
Starvation Cap Reductn			0	0	0		0	0		0		139
Spillback Cap Reductn			0	0	0		0	0		0		0
Storage Cap Reductn			0	0	0		0	0		0		0
Reduced v/c Ratio			0.69	0.73	0.65		0.58	1.09		0.76		0.93

Intersection Summary

Area Type:	Other
Cycle Length:	160
Actuated Cycle Length:	160
Offset:	56 (35%), Referenced to phase 6:NBT, Start of Yellow
Natural Cycle:	125
Control Type:	Actuated-Coordinated
Maximum v/c Ratio:	1.09
Intersection Signal Delay:	47.6
Intersection LOS:	D
Intersection Capacity Utilization:	86.6%
ICU Level of Service:	E
Analysis Period (min):	15
~	Volume exceeds capacity, queue is theoretically infinite. Queue shown is maximum after two cycles.
#	95th percentile volume exceeds capacity, queue may be longer. Queue shown is maximum after two cycles.
m	Volume for 95th percentile queue is metered by upstream signal.

Pepper Square TIA  
Lanes, Volumes, Timings

Phase 1 & P - 2028 Background - PM  
1367: Preston & Belt Line

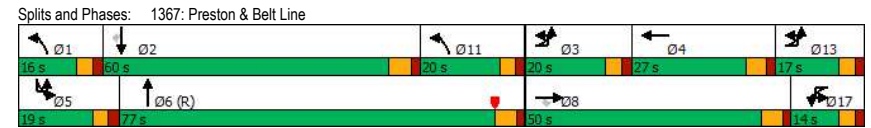

Pepper Square TIA  
Lanes, Volumes, Timings

Phase 1 & P - 2028 Background - PM  
1367: Preston & Belt Lane

Lane Group	SBL	SBT	SBR	Ø1	Ø3	Ø11	Ø13
Total Split (%)	11.9%	37.5%	37.5%	10%	13%	13%	11%
Maximum Green (s)	14.0	54.0	54.0	11.0	15.0	15.0	12.0
Yellow Time (s)	3.0	4.4	4.4	3.0	3.0	3.0	3.0
All-Red Time (s)	2.0	1.6	1.6	2.0	2.0	2.0	2.0
Lost Time Adjust (s)	-1.0	-1.7	-1.7				
Total Lost Time (s)	4.0	4.3	4.3				
Lead/Lag	Lead	Lag	Lag	Lead	Lead		
Lead-Lag Optimize?	Yes	Yes	Yes	Yes	Yes		
Vehicle Extension (s)	1.5	2.5	2.5	1.6	1.3	3.0	3.0
Recall Mode	None	Ped	Ped	None	None	None	None
Walk Time (s)		7.0	7.0				
Flash Dont Walk (s)		20.0	20.0				
Pedestrian Calls (#/hr)		0	0				
Act Effect Green (s)	15.6	54.1	54.1				
Actuated g/C Ratio	0.10	0.34	0.34				
v/c Ratio	0.89	0.86	0.40				
Control Delay	88.8	44.9	10.9				
Queue Delay	0.0	0.0	0.0				
Total Delay	88.8	44.9	10.9				
LOS	F	D	B				
Approach Delay		43.5					
Approach LOS		D					
Queue Length 50th (ft)	147	575	142				
Queue Length 95th (ft)	m#233	m627	m154				
Internal Link Dist (ft)		2974					
Turn Bay Length (ft)	200		300				
Base Capacity (vph)	171	1770	700				
Starvation Cap Reductn	0	0	0				
Spillback Cap Reductn	0	0	0				
Storage Cap Reductn	0	0	0				
Reduced v/c Ratio	0.89	0.84	0.40				

Intersection Summary

Pepper Square TIA  
Lanes, Volumes, Timings

Phase 1 & P - 2028 Background - PM  
1368: Preston & Alexis

Lane Group	EBL	EBT	EBR	WBL	WBT	WBR	NBU	NBL	NBT	NBR	SBL	SBT
Lane Configurations	↔	↔	↔	↔	↔	↔	↔	↔	↔	↔	↔	↔
Traffic Volume (vph)	66	24	64	233	24	79	7	43	2325	238	178	1641
Future Volume (vph)	66	24	64	233	24	79	7	43	2325	238	178	1641
Ideal Flow (vphpl)	1900	1900	1900	1900	1900	1900	1900	1900	1900	1900	1900	1900
Storage Length (ft)	0		0	175		0		150		150	150	
Storage Lanes	1		1	2		1		1		1	1	
Taper Length (ft)	25			25				25			25	
Lane Util. Factor	0.91	0.91	1.00	0.97	1.00	1.00	0.91	1.00	0.91	1.00	1.00	0.91
Frt			0.850			0.850				0.850		
Fit Protected	0.950	0.972		0.950				0.950			0.950	
Satd. Flow (prot)	1610	3295	1583	3433	1863	1583	0	1770	5085	1583	1770	5085
Fit Permitted	0.950	0.972		0.950				0.104			0.040	
Satd. Flow (perm)	1610	3295	1583	3433	1863	1583	0	194	5085	1583	75	5085
Right Turn on Red			Yes			Yes				Yes		
Satd. Flow (RTOR)			125			85				99		
Link Speed (mph)		30			30			43				42
Link Distance (ft)		660			627			2867				173
Travel Time (s)		15.0			14.3			45.5				2.8
Peak Hour Factor	0.95	0.95	0.95	0.95	0.95	0.95	0.95	0.95	0.95	0.95	0.95	0.95
Adj. Flow (vph)	69	25	67	245	25	83	7	45	2447	251	187	1727
Shared Lane Traffic (%)	50%											
Lane Group Flow (vph)	34	60	67	245	25	83	0	52	2447	251	187	1727
Enter Blocked Intersection	No	No	No	No	No	No	No	No	No	No	No	No
Lane Alignment	Left	Left	Right	Left	Left	Right	R NA	Left	Left	Right	Left	Left
Median Width(ft)	24			24				12				12
Link Offset(ft)	0			0				0				0
Crosswalk Width(ft)	16			16				16				16
Two way Left Turn Lane												
Headway Factor	1.00	1.00	1.00	1.00	1.00	1.00	1.00	1.00	1.00	1.00	1.00	1.00
Turning Speed (mph)	15		9	15		9	9	15		9	15	
Number of Detectors	1	1	1	1	1	1	1	1	1	1	1	1
Detector Template												
Leading Detector (ft)	50	50	50	50	50	50	50	50	50	50	50	50
Trailing Detector (ft)	0	0	0	0	0	0	0	0	0	0	0	0
Detector 1 Position(ft)	0	0	0	0	0	0	0	0	0	0	0	0
Detector 1 Size(ft)	50	50	50	50	50	50	50	50	50	50	50	50
Detector 1 Type	CI+Ex	CI+Ex	CI+Ex	CI+Ex	CI+Ex	CI+Ex	CI+Ex	CI+Ex	CI+Ex	CI+Ex	CI+Ex	CI+Ex
Detector 1 Channel												
Detector 1 Extend (s)	0.0	0.0	0.0	0.0	0.0	0.0	0.0	0.0	0.0	0.0	0.0	0.0
Detector 1 Queue (s)	0.0	0.0	0.0	0.0	0.0	0.0	0.0	0.0	0.0	0.0	0.0	0.0
Detector 1 Delay (s)	0.0	0.0	0.0	0.0	0.0	0.0	0.0	0.0	0.0	0.0	0.0	0.0
Turn Type	Split	NA	Perm	Split	NA	pm+ov	D,P+P	D,P+P	NA	Perm	D,P+P	NA
Permitted Phases	3	3		4	4	5	1	1	6		5	2
Permitted Phases			3		4	2	2			6		6
Detector Phase	3	3	3	4	4	5	1	1	6	6	5	2
Switch Phase												
Minimum Initial (s)	6.0	6.0	6.0	8.0	8.0	3.0	3.0	3.0	14.0	14.0	3.0	14.0
Minimum Split (s)	27.0	27.0	27.0	27.0	27.0	8.4	8.4	8.4	24.0	24.0	8.4	24.0
Total Split (s)	23.0	23.0	23.0	22.0	22.0	20.0	15.0	15.0	95.0	95.0	20.0	100.0

Pepper Square TIA  
Lanes, Volumes, Timings

Phase 1 & P - 2028 Background - PM  
1368: Preston & Alexis

Lane Group	SBR
Left Configurations	↑
Traffic Volume (vph)	23
Future Volume (vph)	23
Ideal Flow (vphpl)	1900
Storage Length (ft)	150
Storage Lanes	1
Taper Length (ft)	
Lane Util. Factor	1.00
Frt	0.850
Fit Protected	
Satd. Flow (prot)	1583
Fit Permitted	
Satd. Flow (perm)	1583
Right Turn on Red	Yes
Satd. Flow (RTOR)	78
Link Speed (mph)	
Link Distance (ft)	
Travel Time (s)	
Peak Hour Factor	0.95
Adj. Flow (vph)	24
Shared Lane Traffic (%)	
Lane Group Flow (vph)	24
Enter Blocked Intersection	No
Lane Alignment	Right
Median Width(ft)	
Link Offset(ft)	
Crosswalk Width(ft)	
Two way Left Turn Lane	
Headway Factor	1.00
Turning Speed (mph)	9
Number of Detectors	1
Detector Template	
Leading Detector (ft)	50
Trailing Detector (ft)	0
Detector 1 Position(ft)	0
Detector 1 Size(ft)	50
Detector 1 Type	CI+Ex
Detector 1 Channel	
Detector 1 Extend (s)	0.0
Detector 1 Queue (s)	0.0
Detector 1 Delay (s)	0.0
Turn Type	Perm
Protected Phases	
Permitted Phases	2
Detector Phase	2
Switch Phase	
Minimum Initial (s)	14.0
Minimum Split (s)	24.0
Total Split (s)	100.0

09/26/2022 4:33 pm  
Kimley-Horn

Synchro 11 Report  
Page 17

Pepper Square TIA  
Lanes, Volumes, Timings

Phase 1 & P - 2028 Background - PM  
1368: Preston & Alexis

Lane Group	EBL	EBT	EBR	WBL	WBT	WBR	NBU	NBL	NBT	NBR	SBL	SBT
Total Split (%)	14.4%	14.4%	14.4%	13.8%	13.8%	12.5%	9.4%	9.4%	59.4%	59.4%	12.5%	62.5%
Maximum Green (s)	18.0	18.0	18.0	17.0	17.0	15.6	10.6	10.6	89.0	89.0	15.6	94.0
Yellow Time (s)	4.0	4.0	4.0	4.0	4.0	3.4	3.4	3.4	4.5	4.5	3.4	4.5
All-Red Time (s)	1.0	1.0	1.0	1.0	1.0	1.0	1.0	1.0	1.5	1.5	1.0	1.5
Lost Time Adjust (s)	-1.0	-1.0	0.0	-1.0	-1.0	0.0			-1.0	-2.0	0.0	-1.0
Total Lost Time (s)	4.0	4.0	5.0	4.0	4.0	4.4			3.4	4.0	6.0	3.4
Lead/Lag	Lag	Lag	Lag	Lead	Lead	Lag	Lead	Lead	Lead	Lead	Lag	Lag
Lead-Lag Optimize?	Yes	Yes	Yes	Yes	Yes	Yes	Yes	Yes	Yes	Yes	Yes	Yes
Vehicle Extension (s)	2.0	2.0	2.0	2.0	2.0	1.2	1.2	1.2	2.5	2.5	1.2	2.5
Recall Mode	None	None	None	None	None	None	None	None	Max	Max	None	C-Max
Walk Time (s)	4.0	4.0	4.0	4.0	4.0				4.0	4.0		4.0
Flash Dont Walk (s)	18.0	18.0	18.0	18.0	18.0				14.0	14.0		14.0
Pedestrian Calls (#/hr)	0	0	0	0	0				0	0		0
Act Effect Green (s)	9.1	9.1	8.1	16.0	16.0	35.6		120.7	102.9	100.9	120.1	115.3
Actuated g/C Ratio	0.06	0.06	0.05	0.10	0.10	0.22		0.75	0.64	0.63	0.75	0.72
v/c Ratio	0.37	0.32	0.34	0.71	0.13	0.20		0.26	0.75	0.24	0.81	0.47
Control Delay	83.4	76.3	4.5	81.6	66.4	9.7		7.6	18.2	6.4	51.5	3.1
Queue Delay	0.0	0.0	0.0	0.0	0.0	0.0		0.0	0.0	0.0	0.0	0.0
Total Delay	83.4	76.3	4.5	81.6	66.4	9.7		7.6	18.2	6.4	51.5	3.2
LOS	F	E	A	F	E	A		A	B	A	D	A
Approach Delay			47.9			63.6			16.9			7.8
Approach LOS			D			E			B			A
Queue Length 50th (ft)	38	34	0	129	24	0		10	528	41	148	91
Queue Length 95th (ft)	80	60	0	177	57	45		21	715	72	#281	90
Internal Link Dist (ft)			580			547			2787			93
Turn Bay Length (ft)					175			150		150	150	
Base Capacity (vph)	191	391	289	386	209	418		263	3269	1034	231	3663
Starvation Cap Reductn	0	0	0	0	0	0		0	0	0	0	299
Spillback Cap Reductn	0	0	0	0	0	0		0	0	0	0	0
Storage Cap Reductn	0	0	0	0	0	0		0	0	0	0	0
Reduced v/c Ratio	0.18	0.15	0.23	0.63	0.12	0.20		0.20	0.75	0.24	0.81	0.51

Intersection Summary

Area Type: Other  
 Cycle Length: 160  
 Actuated Cycle Length: 160  
 Offset: 63 (39%), Referenced to phase 2:NBSB, Start of Yellow  
 Natural Cycle: 140  
 Control Type: Actuated-Coordinated  
 Maximum v/c Ratio: 0.81  
 Intersection Signal Delay: 17.6  
 Intersection LOS: B  
 Intersection Capacity Utilization 78.1%  
 ICU Level of Service D  
 Analysis Period (min) 15  
 # 95th percentile volume exceeds capacity, queue may be longer.  
 Queue shown is maximum after two cycles.  
 m Volume for 95th percentile queue is metered by upstream signal.

Splits and Phases: 1368: Preston & Alexis

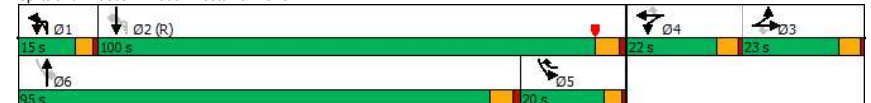

Pepper Square TIA  
Lanes, Volumes, Timings

Phase 1 & P - 2028 Background - PM  
1368: Preston & Alexis

Lane Group	SBR
Total Split (%)	62.5%
Maximum Green (s)	94.0
Yellow Time (s)	4.5
All-Red Time (s)	1.5
Lost Time Adjust (s)	0.0
Total Lost Time (s)	6.0
Lead/Lag	Lag
Lead-Lag Optimize?	Yes
Vehicle Extension (s)	2.5
Recall Mode	C-Max
Walk Time (s)	4.0
Flash Dont Walk (s)	14.0
Pedestrian Calls (#/hr)	0
Act Effect Green (s)	113.3
Actuated g/C Ratio	0.71
v/c Ratio	0.02
Control Delay	0.0
Queue Delay	0.0
Total Delay	0.0
LOS	A
Approach Delay	
Approach LOS	
Queue Length 50th (ft)	0
Queue Length 95th (ft)	m0
Internal Link Dist (ft)	
Turn Bay Length (ft)	150
Base Capacity (vph)	1143
Starvation Cap Reductn	0
Spillback Cap Reductn	0
Storage Cap Reductn	0
Reduced v/c Ratio	0.02

Intersection Summary

Pepper Square TIA  
Lanes, Volumes, Timings

Phase 1 & P - 2028 Background - PM  
1369: Preston & Belt Line Village Driveway

Lane Group	EBL	EBT	EBR	WBL	WBT	WBR	NBU	NBL	NBT	NBR	SBU	SBL
Lane Configurations		↕↕			↕↕			↕↕	↕↕↕			↕
Traffic Volume (vph)	80	5	54	25	6	19	1	67	2269	12	8	58
Future Volume (vph)	80	5	54	25	6	19	1	67	2269	12	8	58
Ideal Flow (vphpl)	1900	1900	1900	1900	1900	1900	1900	1900	1900	1900	1900	1900
Storage Length (ft)	0	0	0	0	0	0	100	0	0	0	0	100
Storage Lanes	0	0	0	0	0	0	1	0	0	0	0	1
Taper Length (ft)	25			25			25					25
Lane Util. Factor	0.95	0.95	0.95	1.00	1.00	1.00	0.91	1.00	0.91	0.91	0.91	1.00
Frt	0.941				0.948				0.999			
Fit Protected		0.972			0.976			0.950				0.950
Satd. Flow (prot)	0	3237	0	0	1724	0	0	1770	5080	0	0	1770
Fit Permitted		0.761			0.811			0.076				0.045
Satd. Flow (perm)	0	2534	0	0	1432	0	0	142	5080	0	0	84
Right Turn on Red			Yes			Yes				Yes		
Satd. Flow (RTOR)		56			19				1			
Link Speed (mph)		30			30				42			
Link Distance (ft)		303			249				252			
Travel Time (s)		6.9			5.7				4.1			
Peak Hour Factor	0.97	0.97	0.97	0.97	0.97	0.97	0.97	0.97	0.97	0.97	0.97	0.97
Adj. Flow (vph)	82	5	56	26	6	20	1	69	2339	12	8	60
Shared Lane Traffic (%)												
Lane Group Flow (vph)	0	143	0	0	52	0	0	70	2351	0	0	68
Enter Blocked Intersection	No	No	No	No	No	No	No	No	No	No	No	No
Lane Alignment	Left	Left	Right	Left	Left	Right	R NA	Left	Left	Right	R NA	Left
Median Width(ft)		0			0				12			
Link Offset(ft)		0			0				0			
Crosswalk Width(ft)		16			16				16			
Two way Left Turn Lane												
Headway Factor	1.00	1.00	1.00	1.00	1.00	1.00	1.00	1.00	1.00	1.00	1.00	1.00
Turning Speed (mph)	15		9	15		9	9	15		9	9	15
Number of Detectors	1	1		1	1		1	1	1		1	1
Detector Template												
Leading Detector (ft)	50	50		50	50		50	50	50		50	50
Trailing Detector (ft)	0	0		0	0		0	0	0		0	0
Detector 1 Position(ft)	0	0		0	0		0	0	0		0	0
Detector 1 Size(ft)	50	50		50	50		50	50	50		50	50
Detector 1 Type	CI+Ex	CI+Ex		CI+Ex	CI+Ex		CI+Ex	CI+Ex	CI+Ex		CI+Ex	CI+Ex
Detector 1 Channel												
Detector 1 Extend (s)	0.0	0.0		0.0	0.0		0.0	0.0	0.0		0.0	0.0
Detector 1 Queue (s)	0.0	0.0		0.0	0.0		0.0	0.0	0.0		0.0	0.0
Detector 1 Delay (s)	0.0	0.0		0.0	0.0		0.0	0.0	0.0		0.0	0.0
Turn Type	Perm	NA		Perm	NA		custom	D,P+P	NA		custom	D,P+P
Protected Phases		8			4			1	6			5
Permitted Phases	8			4			1	2			5	6
Detector Phase	8	8		4	4		1	1	6		5	5
Switch Phase												
Minimum Initial (s)	20.0	20.0		20.0	20.0		5.0	5.0	20.0		5.0	5.0
Minimum Split (s)	25.0	25.0		25.0	25.0		10.0	10.0	26.0		10.0	10.0
Total Split (s)	47.0	47.0		47.0	47.0		20.0	20.0	98.0		15.0	15.0

Pepper Square TIA  
Lanes, Volumes, Timings

Phase 1 & P - 2028 Background - PM  
1369: Preston & Belt Line Village Driveway

Lane Group	SBT	SBR
Lane Configurations	↑↑↑	
Traffic Volume (vph)	1913	26
Future Volume (vph)	1913	26
Ideal Flow (vphpl)	1900	1900
Storage Length (ft)		0
Storage Lanes		0
Taper Length (ft)		
Lane Util. Factor	0.91	0.91
Frt	0.998	
Fit Protected		
Satd. Flow (prot)	5075	0
Fit Permitted		
Satd. Flow (perm)	5075	0
Right Turn on Red		Yes
Satd. Flow (RTOR)	2	
Link Speed (mph)	38	
Link Distance (ft)	191	
Travel Time (s)	3.4	
Peak Hour Factor	0.97	0.97
Adj. Flow (vph)	1972	27
Shared Lane Traffic (%)		
Lane Group Flow (vph)	1999	0
Enter Blocked Intersection	No	No
Lane Alignment	Left	Right
Median Width(ft)	12	
Link Offset(ft)	0	
Crosswalk Width(ft)	16	
Two way Left Turn Lane		
Headway Factor	1.00	1.00
Turning Speed (mph)		9
Number of Detectors	1	
Detector Template		
Leading Detector (ft)	50	
Trailing Detector (ft)	0	
Detector 1 Position(ft)	0	
Detector 1 Size(ft)	50	
Detector 1 Type	CI+Ex	
Detector 1 Channel		
Detector 1 Extend (s)	0.0	
Detector 1 Queue (s)	0.0	
Detector 1 Delay (s)	0.0	
Turn Type	NA	
Protected Phases	2	
Permitted Phases		
Detector Phase	2	
Switch Phase		
Minimum Initial (s)	20.0	
Minimum Split (s)	26.0	
Total Split (s)	93.0	

09/26/2022 4:33 pm  
Kimley-Horn

Synchro 11 Report  
Page 21

Pepper Square TIA  
Lanes, Volumes, Timings

Phase 1 & P - 2028 Background - PM  
1369: Preston & Belt Line Village Driveway

Lane Group	EBL	EBT	EBR	WBL	WBT	WBR	NBU	NBL	NBT	NBR	SBU	SBL
Total Split (%)	29.4%	29.4%		29.4%	29.4%		12.5%	12.5%	61.3%		9.4%	9.4%
Maximum Green (s)	42.3	42.3		42.3	42.3		15.0	15.0	93.7		10.0	10.0
Yellow Time (s)	3.0	3.0		3.0	3.0		3.0	3.0	3.0		3.0	3.0
All-Red Time (s)	1.7	1.7		1.7	1.7		2.0	2.0	1.3		2.0	2.0
Lost Time Adjust (s)		-1.0			-1.0			-1.0	-2.0			-1.0
Total Lost Time (s)		3.7			3.7			4.0	2.3			4.0
Lead/Lag							Lead	Lead	Lead		Lag	Lag
Lead-Lag Optimize?							Yes	Yes	Yes		Yes	Yes
Vehicle Extension (s)	2.0	2.0		2.0	2.0		1.5	1.5	3.0		1.5	1.5
Recall Mode	None	None		None	None		None	None	Max		None	None
Walk Time (s)	5.0	5.0		5.0	5.0				7.0			
Flash Dont Walk (s)	15.0	15.0		15.0	15.0				8.0			
Pedestrian Calls (#/hr)	0	0		0	0				0			
Act Effect Green (s)		21.0			21.0		127.3	118.0				127.3
Actuated g/C Ratio		0.13			0.13		0.80	0.74				0.80
v/c Ratio		0.38			0.25		0.36	0.63				0.37
Control Delay		41.3			45.6		14.5	2.1				27.5
Queue Delay		0.0			0.0		0.0	0.2				0.0
Total Delay		41.3			45.6		14.5	2.3				27.5
LOS		D			D		B	A				C
Approach Delay		41.3			45.6			2.7				
Approach LOS		D			D			A				
Queue Length 50th (ft)		43			31		3	43				26
Queue Length 95th (ft)		81			77		m18	43				m40
Internal Link Dist (ft)		223			169			172				
Turn Bay Length (ft)							100					100
Base Capacity (vph)		726			401		279	3746				182
Starvation Cap Reductn		0			0		0	549				0
Spillback Cap Reductn		2			0		0	428				0
Storage Cap Reductn		0			0		0	0				0
Reduced v/c Ratio		0.20			0.13		0.25	0.74				0.37

Intersection Summary

Area Type: Other  
 Cycle Length: 160  
 Actuated Cycle Length: 160  
 Offset: 86 (54%), Referenced to phase 2:NBSB, Start of Yellow  
 Natural Cycle: 70  
 Control Type: Actuated-Coordinated  
 Maximum v/c Ratio: 0.63  
 Intersection Signal Delay: 5.1  
 Intersection LOS: A  
 Intersection Capacity Utilization 74.9%  
 ICU Level of Service D  
 Analysis Period (min) 15  
 m Volume for 95th percentile queue is metered by upstream signal.

Splits and Phases: 1369: Preston & Belt Line Village Driveway

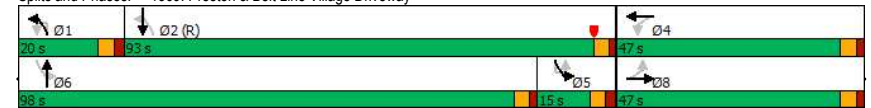

Kimley-Horn

Page 22

Pepper Square TIA  
Lanes, Volumes, Timings

Phase 1 & P - 2028 Background - PM  
1369: Preston & Belt Line Village Driveway

Lane Group	SBT	SBR
Total Split (%)	58.1%	
Maximum Green (s)	88.7	
Yellow Time (s)	3.0	
All-Red Time (s)	1.3	
Lost Time Adjust (s)	-2.0	
Total Lost Time (s)	2.3	
Lead/Lag	Lag	
Lead-Lag Optimize?	Yes	
Vehicle Extension (s)	3.3	
Recall Mode	C-Max	
Walk Time (s)	7.0	
Flash Dont Walk (s)	8.0	
Pedestrian Calls (#/hr)	0	
Act Effect Green (s)	121.2	
Actuated g/C Ratio	0.76	
v/c Ratio	0.52	
Control Delay	3.2	
Queue Delay	0.3	
Total Delay	3.5	
LOS	A	
Approach Delay	4.3	
Approach LOS	A	
Queue Length 50th (ft)	91	
Queue Length 95th (ft)	131	
Internal Link Dist (ft)	111	
Turn Bay Length (ft)		
Base Capacity (vph)	3845	
Starvation Cap Reductn	1027	
Spillback Cap Reductn	0	
Storage Cap Reductn	0	
Reduced v/c Ratio	0.71	
<b>Intersection Summary</b>		

Pepper Square TIA  
Lanes, Volumes, Timings

Phase 1 & P - 2028 Background - PM  
1371: Preston & Spring Valley

Lane Group	EBL	EBT	EBR	WBL	WBT	WBR	NBU	NBL	NBT	NBR	SBU	SBL
Lane Configurations	↑↑	↑↑↑		↑↑	↑↑↑			↑↑	↑↑↑			↑↑
Traffic Volume (vph)	307	787	225	104	484	161	1	191	2235	198	6	155
Future Volume (vph)	307	787	225	104	484	161	1	191	2235	198	6	155
Ideal Flow (vphpl)	1900	1900	1900	1900	1900	1900	1900	1900	1900	1900	1900	1900
Storage Length (ft)	225		0	225		0		225		0		275
Storage Lanes	2		0	2		0		2		0		2
Taper Length (ft)	25			25				25				25
Lane Util. Factor	0.97	0.91	0.91	0.97	0.91	0.91	0.91	0.97	0.91	0.91	0.91	0.97
Fr		0.967			0.963				0.988			
Fit Protected	0.950			0.950				0.950				0.950
Satd. Flow (prot)	3433	4917	0	3433	4897	0	0	3433	5024	0	0	3433
Fit Permitted	0.950			0.950				0.950				0.950
Satd. Flow (perm)	3433	4917	0	3433	4897	0	0	3433	5024	0	0	3433
Right Turn on Red			Yes			Yes				Yes		
Satd. Flow (RTOR)		45			42				13			
Link Speed (mph)		38			42				41			
Link Distance (ft)		3259			5488				2139			
Travel Time (s)		58.5			89.1				35.6			
Peak Hour Factor	0.94	0.94	0.94	0.94	0.94	0.94	0.94	0.94	0.94	0.94	0.94	0.94
Adj. Flow (vph)	327	837	239	111	515	171	1	203	2378	211	6	165
Shared Lane Traffic (%)												
Lane Group Flow (vph)	327	1076	0	111	686	0	0	204	2589	0	0	171
Enter Blocked Intersection	No	No	No	No	No	No	No	No	No	No	No	No
Lane Alignment	Left	Left	Right	Left	Left	Right	R NA	Left	Left	Right	R NA	Left
Median Width(ft)		24			24				24			
Link Offset(ft)		0			0				0			
Crosswalk Width(ft)		16			16				16			
Two way Left Turn Lane												
Headway Factor	1.00	1.00	1.00	1.00	1.00	1.00	1.00	1.00	1.00	1.00	1.00	1.00
Turning Speed (mph)	15		9	15		9	9	15		9	9	15
Number of Detectors	1	1		1	1		1	1	1	1	1	1
Detector Template												
Leading Detector (ft)	50	50		50	50		50	50	50		50	50
Trailing Detector (ft)	0	0		0	0		0	0	0		0	0
Detector 1 Position(ft)	0	0		0	0		0	0	0		0	0
Detector 1 Size(ft)	50	50		50	50		50	50	50		50	50
Detector 1 Type	CI+Ex	CI+Ex		CI+Ex	CI+Ex		CI+Ex	CI+Ex	CI+Ex		CI+Ex	CI+Ex
Detector 1 Channel												
Detector 1 Extend (s)	0.0	0.0		0.0	0.0		0.0	0.0	0.0		0.0	0.0
Detector 1 Queue (s)	0.0	0.0		0.0	0.0		0.0	0.0	0.0		0.0	0.0
Detector 1 Delay (s)	0.0	0.0		0.0	0.0		0.0	0.0	0.0		0.0	0.0
Turn Type	Prot	NA		Prot	NA		Prot	Prot	NA		Prot	Prot
Protected Phases	3	8		7	4		1	1	6		5	5
Permitted Phases												
Detector Phase	3	8		7	4		1	1	6		5	5
Switch Phase												
Minimum Initial (s)	6.0	12.0		3.0	12.0		3.0	3.0	13.0		3.0	3.0
Minimum Split (s)	11.0	27.5		11.0	27.5		11.0	11.0	28.0		11.0	11.0
Total Split (s)	40.0	50.0		13.0	23.0		22.0	22.0	82.0		15.0	15.0



Pepper Square TIA  
Lanes, Volumes, Timings

Phase 1 & P - 2028 Background - PM  
1371: Preston & Spring Valley

Lane Group	SBT	SBR
Lane Configurations	↑↑↓	
Traffic Volume (vph)	1580	186
Future Volume (vph)	1580	186
Ideal Flow (vphpl)	1900	1900
Storage Length (ft)		0
Storage Lanes		0
Taper Length (ft)		
Lane Util. Factor	0.91	0.91
Frt	0.984	
Fit Protected		
Satd. Flow (prot)	5004	0
Fit Permitted		
Satd. Flow (perm)	5004	0
Right Turn on Red		Yes
Satd. Flow (RTOR)	16	
Link Speed (mph)	38	
Link Distance (ft)	1208	
Travel Time (s)	21.7	
Peak Hour Factor	0.94	0.94
Adj. Flow (vph)	1681	198
Shared Lane Traffic (%)		
Lane Group Flow (vph)	1879	0
Enter Blocked Intersection	No	No
Lane Alignment	Left	Right
Median Width(ft)	24	
Link Offset(ft)	0	
Crosswalk Width(ft)	16	
Two way Left Turn Lane		
Headway Factor	1.00	1.00
Turning Speed (mph)		9
Number of Detectors	1	
Detector Template		
Leading Detector (ft)	50	
Trailing Detector (ft)	0	
Detector 1 Position(ft)	0	
Detector 1 Size(ft)	50	
Detector 1 Type	CI+Ex	
Detector 1 Channel		
Detector 1 Extend (s)	0.0	
Detector 1 Queue (s)	0.0	
Detector 1 Delay (s)	0.0	
Turn Type	NA	
Protected Phases	2	
Permitted Phases		
Detector Phase	2	
Switch Phase		
Minimum Initial (s)	18.0	
Minimum Split (s)	28.0	
Total Split (s)	75.0	

Pepper Square TIA  
Lanes, Volumes, Timings

Phase 1 & P - 2028 Background - PM  
1371: Preston & Spring Valley

Lane Group	EBL	EBT	EBR	WBL	WBT	WBR	NBU	NBL	NBT	NBR	SBU	SBL
Total Split (%)	25.0%	31.3%		8.1%	14.4%		13.8%	13.8%	51.3%		9.4%	9.4%
Maximum Green (s)	35.0	44.5		8.0	17.5		17.0	17.0	76.0		10.0	10.0
Yellow Time (s)	3.0	4.0		3.0	4.0		3.0	3.0	4.5		3.0	3.0
All-Red Time (s)	2.0	1.5		2.0	1.5		2.0	2.0	1.5		2.0	2.0
Lost Time Adjust (s)	-1.0	-1.5		-1.0	-1.5			-1.0	-2.0			-1.0
Total Lost Time (s)	4.0	4.0		4.0	4.0			4.0	4.0			4.0
Lead/Lag	Lead	Lead		Lag	Lag		Lead	Lead	Lead		Lag	Lag
Lead-Lag Optimize?	Yes	Yes		Yes	Yes		Yes	Yes	Yes		Yes	Yes
Vehicle Extension (s)	0.8	2.0		0.8	2.0		0.8	0.8	2.5		0.8	0.8
Recall Mode	None	Max		None	Max		None	None	None		None	None
Walk Time (s)		4.0			4.0				4.0			
Flash Dont Walk (s)		18.0			18.0				18.0			
Pedestrian Calls (#/hr)		0			0				0			
Act Effect Green (s)	19.6	46.0		9.0	35.4			13.7	78.0			11.0
Actuated g/C Ratio	0.12	0.29		0.06	0.22			0.09	0.49			0.07
v/c Ratio	0.78	0.74		0.58	0.61			0.69	1.05			0.72
Control Delay	76.1	51.5		70.7	49.4			82.7	75.7			72.5
Queue Delay	0.0	0.0		0.0	0.0			0.0	0.0			0.0
Total Delay	76.1	51.5		70.7	49.4			82.7	75.7			72.5
LOS	E	D		E	D			F	E			E
Approach Delay		57.3			52.4				76.2			
Approach LOS		E			D				E			
Queue Length 50th (ft)	171	377		60	230			112	~1048			91
Queue Length 95th (ft)	223	423		m57	m235			m155	#1131			m123
Internal Link Dist (ft)		3179			5408				2059			
Turn Bay Length (ft)	225			225				225				275
Base Capacity (vph)	772	1445		193	1116			386	2455			236
Starvation Cap Reductn	0	0		0	0			0	0			0
Spillback Cap Reductn	0	0		0	0			0	0			0
Storage Cap Reductn	0	0		0	0			0	0			0
Reduced v/c Ratio	0.42	0.74		0.58	0.61			0.53	1.05			0.72

Intersection Summary

Area Type:	Other
Cycle Length:	160
Actuated Cycle Length:	160
Offset:	135 (84%), Referenced to phase 2:SBT, Start of Yellow
Natural Cycle:	110
Control Type:	Actuated-Coordinated
Maximum v/c Ratio:	1.05
Intersection Signal Delay:	56.1
Intersection LOS:	E
Intersection Capacity Utilization:	89.1%
ICU Level of Service:	E
Analysis Period (min):	15
~	Volume exceeds capacity, queue is theoretically infinite. Queue shown is maximum after two cycles.
#	95th percentile volume exceeds capacity, queue may be longer. Queue shown is maximum after two cycles.
m	Volume for 95th percentile queue is metered by upstream signal.

Pepper Square TIA  
Lanes, Volumes, Timings

Phase 1 & P - 2028 Background - PM  
1371: Preston & Spring Valley

Splits and Phases: 1371: Preston & Spring Valley

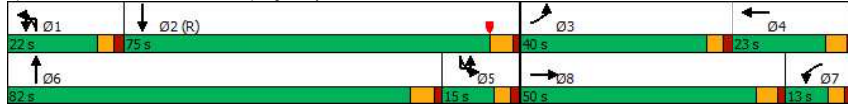

Pepper Square TIA  
Lanes, Volumes, Timings

Phase 1 & P - 2028 Background - PM  
1371: Preston & Spring Valley

Lane Group	SBT	SBR
Total Split (%)	46.9%	
Maximum Green (s)	69.0	
Yellow Time (s)	4.5	
All-Red Time (s)	1.5	
Lost Time Adjust (s)	-2.0	
Total Lost Time (s)	4.0	
Lead/Lag	Lag	
Lead-Lag Optimize?	Yes	
Vehicle Extension (s)	2.4	
Recall Mode	C-Max	
Walk Time (s)	4.0	
Flash Dont Walk (s)	18.0	
Pedestrian Calls (#/hr)	0	
Act Effect Green (s)	75.3	
Actuated g/C Ratio	0.47	
v/c Ratio	0.80	
Control Delay	25.6	
Queue Delay	0.0	
Total Delay	25.6	
LOS	C	
Approach Delay	29.5	
Approach LOS	C	
Queue Length 50th (ft)	249	
Queue Length 95th (ft)	560	
Internal Link Dist (ft)	1128	
Turn Bay Length (ft)		
Base Capacity (vph)	2362	
Starvation Cap Reductn	0	
Spillback Cap Reductn	0	
Storage Cap Reductn	0	
Reduced v/c Ratio	0.80	
<b>Intersection Summary</b>		

Pepper Square TIA  
Lanes, Volumes, Timings

Phase 1 & P - 2028 Background - PM  
1405: Prestonwood & Belt Line

Lane Group	EBU	EBL	EBT	EBR	WBU	WBL	WBT	WBR	NBL	NBT	NBR	SBL
Lane Configurations		↑↑↑	↑↑↑			↑↑↑	↑↑↑			↑		↑↑
Traffic Volume (vph)	7	80	1645	7	3	2	1315	106	6	1	2	151
Future Volume (vph)	7	80	1645	7	3	2	1315	106	6	1	2	151
Ideal Flow (vphpl)	1900	1900	1900	1900	1900	1900	1900	1900	1900	1900	1900	1900
Storage Length (ft)		200		0		200		0	0		0	300
Storage Lanes		1		0		1		0	0		0	2
Taper Length (ft)		25				25		25				25
Lane Util. Factor	0.91	1.00	0.91	0.91	0.91	1.00	0.91	0.91	1.00	1.00	1.00	0.97
Fr			0.999				0.989			0.970		
Fit Protected		0.950				0.950				0.968		0.950
Satd. Flow (prot)	0	1770	5080	0	0	1770	5029	0	0	1749	0	3433
Fit Permitted		0.074				0.111				0.968		0.950
Satd. Flow (perm)	0	138	5080	0	0	207	5029	0	0	1749	0	3433
Right Turn on Red			Yes				Yes			Yes		
Satd. Flow (RTOR)			1				12			2		
Link Speed (mph)			42				42			30		
Link Distance (ft)			1445				2036			315		
Travel Time (s)			23.5				33.1			7.2		
Peak Hour Factor	0.95	0.95	0.95	0.95	0.95	0.95	0.95	0.95	0.95	0.95	0.95	0.95
Adj. Flow (vph)	7	84	1732	7	3	2	1384	112	6	1	2	159
Shared Lane Traffic (%)												
Lane Group Flow (vph)	0	91	1739	0	0	5	1496	0	0	9	0	159
Enter Blocked Intersection	No	No	No	No	No	No	No	No	No	No	No	No
Lane Alignment	R NA	Left	Left	Right	R NA	Left	Left	Right	Left	Left	Right	Left
Median Width(ft)			24				24			24		
Link Offset(ft)			0				0			0		
Crosswalk Width(ft)			16				16			16		
Two way Left Turn Lane												
Headway Factor	1.00	1.00	1.00	1.00	1.00	1.00	1.00	1.00	1.00	1.00	1.00	1.00
Turning Speed (mph)	9	15		9	9	15		9	15		9	15
Number of Detectors	1	1	1		1	1	1		1	1		1
Detector Template												
Leading Detector (ft)	50	50	50		50	50	50		50	50		50
Trailing Detector (ft)	0	0	0		0	0	0		0	0		0
Detector 1 Position(ft)	0	0	0		0	0	0		0	0		0
Detector 1 Size(ft)	50	50	50		50	50	50		50	50		50
Detector 1 Type	CI+Ex	CI+Ex	CI+Ex		CI+Ex	CI+Ex	CI+Ex		CI+Ex	CI+Ex		CI+Ex
Detector 1 Channel												
Detector 1 Extend (s)	0.0	0.0	0.0		0.0	0.0	0.0		0.0	0.0		0.0
Detector 1 Queue (s)	0.0	0.0	0.0		0.0	0.0	0.0		0.0	0.0		0.0
Detector 1 Delay (s)	0.0	0.0	0.0		0.0	0.0	0.0		0.0	0.0		0.0
Turn Type	D,P+P	D,P+P	NA		custom	D,P+P	NA		Split	NA		Split
Protected Phases	1	1	6			5	2		3	3		4
Permitted Phases	2	2			5	6						
Detector Phase	1	1	6		5	5	2		3	3		4
Switch Phase												
Minimum Initial (s)	3.0	3.0	15.0		3.0	3.0	15.0		5.0	5.0		7.0
Minimum Split (s)	8.0	8.0	22.0		8.0	8.0	24.0		23.0	23.0		23.2
Total Split (s)	25.0	25.0	99.0		15.0	15.0	89.0		18.0	18.0		28.0

Pepper Square TIA  
Lanes, Volumes, Timings

Phase 1 & P - 2028 Background - PM  
1405: Prestonwood & Belt Line

Lane Group	SBT	SBR
Lane Configurations	↑	↑
Traffic Volume (vph)	2	83
Future Volume (vph)	2	83
Ideal Flow (vphpl)	1900	1900
Storage Length (ft)		0
Storage Lanes		1
Taper Length (ft)		
Lane Util. Factor	0.95	0.95
Fr	0.857	0.850
Fit Protected		
Satd. Flow (prot)	1517	1504
Fit Permitted		
Satd. Flow (perm)	1517	1504
Right Turn on Red		Yes
Satd. Flow (RTOR)	43	89
Link Speed (mph)		30
Link Distance (ft)		868
Travel Time (s)		19.7
Peak Hour Factor	0.95	0.95
Adj. Flow (vph)	2	87
Shared Lane Traffic (%)		49%
Lane Group Flow (vph)	45	44
Enter Blocked Intersection	No	No
Lane Alignment	Left	Right
Median Width(ft)		24
Link Offset(ft)		0
Crosswalk Width(ft)		16
Two way Left Turn Lane		
Headway Factor	1.00	1.00
Turning Speed (mph)		9
Number of Detectors	1	1
Detector Template		
Leading Detector (ft)	50	50
Trailing Detector (ft)	0	0
Detector 1 Position(ft)	0	0
Detector 1 Size(ft)	50	50
Detector 1 Type	CI+Ex	CI+Ex
Detector 1 Channel		
Detector 1 Extend (s)	0.0	0.0
Detector 1 Queue (s)	0.0	0.0
Detector 1 Delay (s)	0.0	0.0
Turn Type	NA	custom
Protected Phases	4	
Permitted Phases		1 4
Detector Phase	4	1 4
Switch Phase		
Minimum Initial (s)		7.0
Minimum Split (s)		23.2
Total Split (s)		28.0

Pepper Square TIA  
Lanes, Volumes, Timings

Phase 1 & P - 2028 Background - PM  
1405: Prestonwood & Belt Line



Lane Group	EBU	EBL	EBT	EBR	WBU	WBL	WBT	WBR	NBL	NBT	NBR	SBL
Total Split (%)	15.6%	15.6%	61.9%		9.4%	9.4%	55.6%		11.3%	11.3%		17.5%
Maximum Green (s)	20.0	20.0	93.0		10.0	10.0	83.0		13.0	13.0		22.8
Yellow Time (s)	3.0	3.0	4.5		3.0	3.0	4.5		3.0	3.0		3.2
All-Red Time (s)	2.0	2.0	1.5		2.0	2.0	1.5		2.0	2.0		2.0
Lost Time Adjust (s)		-1.0	-2.0			-1.0	-2.0			-1.0		-1.2
Total Lost Time (s)		4.0	4.0			4.0	4.0			4.0		4.0
Lead/Lag	Lag	Lag	Lag		Lead	Lead	Lead		Lead	Lead		Lag
Lead-Lag Optimize?	Yes	Yes	Yes		Yes	Yes	Yes		Yes	Yes		Yes
Vehicle Extension (s)	1.0	1.0	2.5		1.0	1.0	2.5		1.5	1.5		1.5
Recall Mode	None	None	C-Max		None	None	None		None	None		None
Walk Time (s)			5.0				4.0		4.0	4.0		4.0
Flash Dont Walk (s)			10.0				14.0		14.0	14.0		14.0
Pedestrian Calls (#/hr)			0				0		0	0		0
Act Effect Green (s)		131.2	133.4			134.4	74.7			6.3		12.5
Actuated g/C Ratio		0.82	0.83			0.84	0.47			0.04		0.08
v/c Ratio		0.13	0.41			0.02	0.64			0.13		0.59
Control Delay		17.0	4.8			1.0	21.4			67.0		80.1
Queue Delay		0.0	0.0			0.0	0.0			0.0		0.0
Total Delay		17.0	4.8			1.0	21.4			67.0		80.1
LOS		B	A			A	C			E		F
Approach Delay			5.4				21.3			67.0		
Approach LOS			A				C			E		
Queue Length 50th (ft)		11	46			0	179			7		84
Queue Length 95th (ft)		57	406			m1	m314			28		122
Internal Link Dist (ft)			1365				1956			235		
Turn Bay Length (ft)		200				200						300
Base Capacity (vph)		689	4236			282	2677			154		514
Starvation Cap Reductn		0	0			0	0			0		0
Spillback Cap Reductn		0	0			0	0			0		0
Storage Cap Reductn		0	0			0	0			0		0
Reduced v/c Ratio		0.13	0.41			0.02	0.56			0.06		0.31

Intersection Summary

Area Type: Other  
 Cycle Length: 160  
 Actuated Cycle Length: 160  
 Offset: 60 (38%), Referenced to phase 6:EBWB, Start of Yellow  
 Natural Cycle: 90  
 Control Type: Actuated-Coordinated  
 Maximum v/c Ratio: 0.64  
 Intersection Signal Delay: 15.7 Intersection LOS: B  
 Intersection Capacity Utilization 53.5% ICU Level of Service A  
 Analysis Period (min) 15  
 m Volume for 95th percentile queue is metered by upstream signal.

Splits and Phases: 1405: Prestonwood & Belt Line

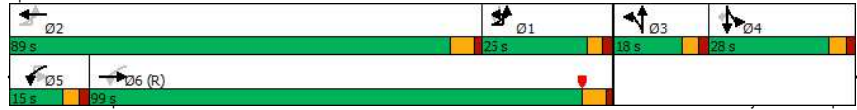

Pepper Square TIA  
Lanes, Volumes, Timings

Phase 1 & P - 2028 Background - PM  
1405: Prestonwood & Belt Line



Lane Group	SBT	SBR
Total Split (%)	17.5%	
Maximum Green (s)	22.8	
Yellow Time (s)	3.2	
All-Red Time (s)	2.0	
Lost Time Adjust (s)	-1.2	
Total Lost Time (s)	4.0	
Lead/Lag	Lag	
Lead-Lag Optimize?	Yes	
Vehicle Extension (s)	1.5	
Recall Mode	None	
Walk Time (s)	4.0	
Flash Dont Walk (s)	14.0	
Pedestrian Calls (#/hr)	0	
Act Effect Green (s)	12.5	71.4
Actuated g/C Ratio	0.08	0.45
v/c Ratio	0.28	0.06
Control Delay	23.5	0.2
Queue Delay	0.0	0.0
Total Delay	23.5	0.2
LOS	C	A
Approach Delay	55.7	
Approach LOS	E	
Queue Length 50th (ft)	2	0
Queue Length 95th (ft)	45	0
Internal Link Dist (ft)	788	
Turn Bay Length (ft)		
Base Capacity (vph)	264	822
Starvation Cap Reductn	0	0
Spillback Cap Reductn	0	0
Storage Cap Reductn	0	0
Reduced v/c Ratio	0.17	0.05

Intersection Summary

Area Type: Other  
 Cycle Length: 160  
 Actuated Cycle Length: 160  
 Offset: 60 (38%), Referenced to phase 6:EBWB, Start of Yellow  
 Natural Cycle: 90  
 Control Type: Actuated-Coordinated  
 Maximum v/c Ratio: 0.64  
 Intersection Signal Delay: 15.7 Intersection LOS: B  
 Intersection Capacity Utilization 53.5% ICU Level of Service A  
 Analysis Period (min) 15  
 m Volume for 95th percentile queue is metered by upstream signal.

Pepper Square TIA  
HCM 6th TWSC

Phase 1 & P - 2028 Background - PM  
2: Ladera Drive & Belt Line

Intersection												
Int Delay, s/veh	9.5											
Movement	EBL	EBT	EBR	WBL	WBT	WBR	NBL	NBT	NBR	SBL	SBT	SBR
Lane Configurations	↔ ↗ ↘			↔ ↗ ↘				↔	↗		↔	↗
Traffic Vol, veh/h	132	1664	57	77	1298	80	17	1	49	38	1	83
Future Vol, veh/h	132	1664	57	77	1298	80	17	1	49	38	1	83
Conflicting Peds, #/hr	0	0	0	0	0	0	0	0	0	0	0	0
Sign Control	Free	Free	Free	Free	Free	Stop	Stop	Stop	Stop	Stop	Stop	Stop
RT Channelized	-	-	None	-	-	None	-	-	None	-	-	None
Storage Length	100	-	-	100	-	-	-	-	0	-	-	0
Veh in Median Storage, #	-	0	-	-	0	-	-	1	-	-	1	-
Grade, %	-	0	-	-	0	-	-	0	-	-	0	-
Peak Hour Factor	96	96	96	96	96	96	96	96	96	96	96	96
Heavy Vehicles, %	2	2	2	2	2	2	2	2	2	2	2	2
Mvmt Flow	138	1733	59	80	1352	83	18	1	51	40	1	86

Major/Minor	Major1	Major2	Minor1	Minor2
Conflicting Flow All	1435	0	0	1792
Stage 1	-	-	-	-
Stage 2	-	-	-	-
Critical Hdwy	5.34	-	-	5.34
Critical Hdwy Stg 1	-	-	-	-
Critical Hdwy Stg 2	-	-	-	-
Follow-up Hdwy	3.12	-	-	3.12
Pot Cap-1 Maneuver	240	-	-	*681
Stage 1	-	-	-	-
Stage 2	-	-	-	-
Platoon blocked, %	-	-	-	-
Mov Cap-1 Maneuver	240	-	-	*681
Mov Cap-2 Maneuver	-	-	-	-
Stage 1	-	-	-	-
Stage 2	-	-	-	-

Approach	EB	WB	NB	SB
HCM Control Delay, s	2.7	0.6	47.2	197.1
HCM LOS			E	F

Minor Lane/Major Mvmt	NBLn1	NBLn2	EBL	EBT	EBR	WBL	WBT	WBR	SBLn1	SBLn2
Capacity (veh/h)	43	541	240	-	-	*681	-	-	27	319
HCM Lane V/C Ratio	0.436	0.094	0.573	-	-	0.118	-	-	1.505	0.271
HCM Control Delay (s)	142.2	12.3	38.4	-	-	11	-	-	\$ 573.1	20.4
HCM Lane LOS	F	B	E	-	-	B	-	-	F	C
HCM 95th %tile Q(veh)	1.5	0.3	3.2	-	-	0.4	-	-	4.8	1.1

Notes  
 ~: Volume exceeds capacity    \$: Delay exceeds 300s    +: Computation Not Defined    \*: All major volume in platoon

Pepper Square TIA  
HCM 6th TWSC

Phase 1 & P - 2028 Background - PM  
3: Median Opening East of Preston Rd & Belt Line

Intersection												
Int Delay, s/veh	0.5											
Movement	EBU	EBL	EBT	EBR	WBU	WBL	WBT	WBR	NBL	NBT	NBR	SBL
Lane Configurations	↔ ↗ ↘				↔ ↗ ↘					↔	↗	↘
Traffic Vol, veh/h	6	6	1205	12	1	13	894	5	2	0	2	21
Future Vol, veh/h	6	6	1205	12	1	13	894	5	2	0	2	21
Conflicting Peds, #/hr	0	0	0	0	0	0	0	0	0	0	0	0
Sign Control	Free	Free	Free	Free	Free	Free	Free	Free	Stop	Stop	Stop	Stop
RT Channelized	-	-	-	None	-	-	-	None	-	-	None	-
Storage Length	-	150	-	-	-	200	-	-	-	-	-	-
Veh in Median Storage, #	-	-	0	-	-	0	-	-	1	-	-	1
Grade, %	-	-	0	-	-	0	-	-	0	-	-	0
Peak Hour Factor	93	93	93	93	93	93	93	93	93	93	93	93
Heavy Vehicles, %	2	2	2	2	2	2	2	2	2	2	2	2
Mvmt Flow	6	6	1296	13	1	14	961	5	2	0	2	23

Major/Minor	Major1	Major2	Minor1	Minor2
Conflicting Flow All	706	966	0	0
Stage 1	-	-	-	-
Stage 2	-	-	-	-
Critical Hdwy	5.64	5.34	-	-
Critical Hdwy Stg 1	-	-	-	-
Critical Hdwy Stg 2	-	-	-	-
Follow-up Hdwy	2.32	3.12	-	-
Pot Cap-1 Maneuver	*1216	*904	-	-
Stage 1	-	-	-	-
Stage 2	-	-	-	-
Platoon blocked, %	1	1	-	-
Mov Cap-1 Maneuver	*1023	*1023	-	-
Mov Cap-2 Maneuver	-	-	-	-
Stage 1	-	-	-	-
Stage 2	-	-	-	-

Approach	EB	WB	NB	SB
HCM Control Delay, s	0.1	0.3	30.2	13.8
HCM LOS			D	B

Minor Lane/Major Mvmt	NBLn1	EBL	EBT	EBR	WBL	WBT	WBR	SBLn1
Capacity (veh/h)	147	*1023	-	-	285	-	-	457
HCM Lane V/C Ratio	0.029	0.013	-	-	0.053	-	-	0.104
HCM Control Delay (s)	30.2	8.6	-	-	18.3	-	-	13.8
HCM Lane LOS	D	A	-	-	C	-	-	B
HCM 95th %tile Q(veh)	0.1	0	-	-	0.2	-	-	0.3

Notes  
 ~: Volume exceeds capacity    \$: Delay exceeds 300s    +: Computation Not Defined    \*: All major volume in platoon

Pepper Square TIA  
HCM 6th TWSC

Phase 1 & P - 2028 Background - PM  
5: Belt Line & Median between Berry Trail and Alexis Dr

Intersection												
Int Delay, s/veh	0.3											
Movement	EBL	EBT	EBR	WBL	WBT	WBR	NBL	NBT	NBR	SBL	SBT	SBR
Lane Configurations	↔ ↑↑↑			↔ ↑↑↑			↔			↔		
Traffic Vol, veh/h	8	1261	2	27	902	12	3	4	11	4	1	7
Future Vol, veh/h	8	1261	2	27	902	12	3	4	11	4	1	7
Conflicting Peds, #/hr	0	0	0	0	0	0	0	0	0	0	0	0
Sign Control	Free	Free	Free	Free	Free	Stop	Stop	Stop	Stop	Stop	Stop	Stop
RT Channelized	-	-	None	-	-	None	-	-	None	-	-	None
Storage Length	150	-	-	150	-	-	-	-	-	-	-	-
Veh in Median Storage, #	-	0	-	-	0	-	-	1	-	-	1	-
Grade, %	-	0	-	-	0	-	-	0	-	-	0	-
Peak Hour Factor	94	94	94	94	94	94	94	94	94	94	94	94
Heavy Vehicles, %	2	2	2	2	2	2	2	2	2	2	2	2
Mvmt Flow	9	1341	2	29	960	13	3	4	12	4	1	7

Major/Minor	Major1	Major2	Minor1	Minor2
Conflicting Flow All	973	0	0	1343
Stage 1	-	-	-	-
Stage 2	-	-	-	-
Critical Hdwy	5.34	-	-	5.34
Critical Hdwy Stg 1	-	-	-	-
Critical Hdwy Stg 2	-	-	-	-
Follow-up Hdwy	3.12	-	-	3.12
Pot Cap-1 Maneuver	901	-	-	*803
Stage 1	-	-	-	-
Stage 2	-	-	-	-
Platoon blocked, %	1	-	-	1
Mov Cap-1 Maneuver	901	-	-	*803
Mov Cap-2 Maneuver	-	-	-	-
Stage 1	-	-	-	-
Stage 2	-	-	-	-

Approach	EB	WB	NB	SB
HCM Control Delay, s	0.1	0.3	11.8	11.2
HCM LOS			B	B

Minor Lane/Major Mvmt	NBLn1	EBL	EBT	EBR	WBL	WBT	WBR	SBLn1
Capacity (veh/h)	546	901	-	-	* 803	-	-	590
HCM Lane V/C Ratio	0.035	0.009	-	-	0.036	-	-	0.022
HCM Control Delay (s)	11.8	9	-	-	9.6	-	-	11.2
HCM Lane LOS	B	A	-	-	A	-	-	B
HCM 95th %tile Q(veh)	0.1	0	-	-	0.1	-	-	0.1

Notes  
 ~: Volume exceeds capacity    \$: Delay exceeds 300s    +: Computation Not Defined    \*: All major volume in platoon

Pepper Square TIA  
HCM 6th TWSC

Phase 1 & P - 2028 Background - PM  
6: Alexis Drive & Belt Line

Intersection						
Int Delay, s/veh	2.9					
Movement	EBT	EBR	WBL	WBT	NBL	NBR
Lane Configurations	↑↑↑		↔ ↑↑↑		↔	
Traffic Vol, veh/h	1243	19	244	929	4	313
Future Vol, veh/h	1243	19	244	929	4	313
Conflicting Peds, #/hr	0	0	0	0	0	0
Sign Control	Free	Free	Free	Free	Stop	Stop
RT Channelized	-	None	-	None	-	Yield
Storage Length	-	-	150	-	0	0
Veh in Median Storage, #	0	-	-	0	1	-
Grade, %	0	-	-	0	0	-
Peak Hour Factor	95	95	95	95	95	95
Heavy Vehicles, %	2	2	2	2	2	2
Mvmt Flow	1308	20	257	978	4	329

Major/Minor	Major1	Major2	Minor1
Conflicting Flow All	0	0	1328
Stage 1	-	-	-
Stage 2	-	-	-
Critical Hdwy	-	-	5.34
Critical Hdwy Stg 1	-	-	-
Critical Hdwy Stg 2	-	-	-
Follow-up Hdwy	-	-	3.12
Pot Cap-1 Maneuver	-	-	*803
Stage 1	-	-	-
Stage 2	-	-	-
Platoon blocked, %	-	-	1
Mov Cap-1 Maneuver	-	-	*803
Mov Cap-2 Maneuver	-	-	-
Stage 1	-	-	-
Stage 2	-	-	-

Approach	EB	WB	NB
HCM Control Delay, s	0	2.4	16.5
HCM LOS			C

Minor Lane/Major Mvmt	NBLn1	NBLn2	EBT	EBR	WBL	WBT
Capacity (veh/h)	395	638	-	-	* 803	-
HCM Lane V/C Ratio	0.011	0.516	-	-	0.32	-
HCM Control Delay (s)	14.2	16.5	-	-	11.6	-
HCM Lane LOS	B	C	-	-	B	-
HCM 95th %tile Q(veh)	0	3	-	-	1.4	-

Notes  
 ~: Volume exceeds capacity    \$: Delay exceeds 300s    +: Computation Not Defined    \*: All major volume in platoon

Pepper Square TIA  
HCM 6th TWSC

Phase 1 & P - 2028 Background - PM  
10: Preston & Pepper Square Driveway

Intersection														
Int Delay, s/veh	8.2													
Movement	EBL	EBT	EBR	WBL	WBT	WBR	NBU	NBL	NBT	NBR	SBU	SBL	SBT	SBR
Lane Configurations		↔		↔				↔	↔	↔		↔	↔	↔
Traffic Vol, veh/h	11	5	61	9	2	54	4	95	2302	34	6	24	1820	69
Future Vol, veh/h	11	5	61	9	2	54	4	95	2302	34	6	24	1820	69
Conflicting Peds, #/hr	0	0	0	0	0	0	0	0	0	0	0	0	0	0
Sign Control	Stop	Stop	Stop	Stop	Stop	Free	Free	Free	Free	Free	Free	Free	Free	Free
RT Channelized	-	-	None	-	-	None	-	-	None	-	-	-	-	None
Storage Length	-	-	-	-	-	-	-	150	-	-	-	150	-	-
Veh in Median Storage, #	-	1	-	-	1	-	-	-	0	-	-	-	0	-
Grade, %	-	0	-	-	0	-	-	-	0	-	-	-	0	-
Peak Hour Factor	97	97	97	97	97	97	97	97	97	97	97	97	97	97
Heavy Vehicles, %	2	2	2	2	2	2	2	2	2	2	2	2	2	2
Mvmt Flow	11	5	63	9	2	56	4	98	2373	35	6	25	1876	71

Major/Minor	Minor2	Minor1	Major1	Major2
Conflicting Flow All	3128	4586	974	3410
Stage 1	1974	1974	-	2595
Stage 2	1154	2612	-	815
Critical Hdwy	6.44	6.54	7.14	6.44
Critical Hdwy Stg 1	7.34	5.54	-	7.34
Critical Hdwy Stg 2	6.74	5.54	-	6.74
Follow-up Hdwy	3.82	4.02	3.92	3.82
Pot Cap-1 Maneuver	*34	*~ 1	*509	*16
Stage 1	*522	*497	-	*14
Stage 2	*188	*50	-	*522
Platoon blocked, %	1	1	1	1
Mov Cap-1 Maneuver	*13	*0	*509	*~ 9
Mov Cap-2 Maneuver	*53	*10	-	*11
Stage 1	*440	*307	-	*12
Stage 2	*95	*42	-	*279

Approach	EB	WB	NB	SB
HCM Control Delay, s	137.1	\$ 349.8	0.5	1.2
HCM LOS	F	F		

Minor Lane/Major Mvmt	NBL	NBT	NBR	EBLn1	WBLn1	SBL	SBT	SBR
Capacity (veh/h)	* 644	-	-	93	52	81	-	-
HCM Lane V/C Ratio	0.158	-	-	0.854	1.289	0.382	-	-
HCM Control Delay (s)	11.6	-	-	137.1\$	349.8	74	-	-
HCM Lane LOS	B	-	-	F	F	F	-	-
HCM 95th %tile Q(veh)	0.6	-	-	4.7	6	1.5	-	-

Notes  
 ~: Volume exceeds capacity    \$: Delay exceeds 300s    +: Computation Not Defined    \*: All major volume in platoon

Pepper Square TIA  
HCM 6th TWSC

Phase 1 & P - 2028 Background - PM  
20: Preston & Drive 2

Intersection						
Int Delay, s/veh	0.1					
Movement	WBL	WBR	NBT	NBR	SBL	SBT
Lane Configurations		↔	↔	↔	↔	↔
Traffic Vol, veh/h	0	14	2350	8	0	2005
Future Vol, veh/h	0	14	2350	8	0	2005
Conflicting Peds, #/hr	0	0	0	0	0	0
Sign Control	Stop	Stop	Free	Free	Free	Free
RT Channelized	-	None	-	None	-	None
Storage Length	-	0	-	-	-	-
Veh in Median Storage, #	0	-	0	-	-	0
Grade, %	0	-	0	-	-	0
Peak Hour Factor	95	95	95	95	95	95
Heavy Vehicles, %	2	2	2	2	2	2
Mvmt Flow	0	15	2474	8	0	2111

Major/Minor	Minor1	Major1	Major2
Conflicting Flow All	-	1241	0
Stage 1	-	-	-
Stage 2	-	-	-
Critical Hdwy	-	7.14	-
Critical Hdwy Stg 1	-	-	-
Critical Hdwy Stg 2	-	-	-
Follow-up Hdwy	-	3.92	-
Pot Cap-1 Maneuver	0	143	-
Stage 1	0	-	-
Stage 2	0	-	-
Platoon blocked, %	-	-	-
Mov Cap-1 Maneuver	-	143	-
Mov Cap-2 Maneuver	-	-	-
Stage 1	-	-	-
Stage 2	-	-	-

Approach	WB	NB	SB
HCM Control Delay, s	33	0	0
HCM LOS	D		

Minor Lane/Major Mvmt	NBT	NBR	WBLn1	SBT
Capacity (veh/h)	-	-	143	-
HCM Lane V/C Ratio	-	-	0.103	-
HCM Control Delay (s)	-	-	33	-
HCM Lane LOS	-	-	D	-
HCM 95th %tile Q(veh)	-	-	0.3	-

Pepper Square TIA  
HCM 6th TWSC

Phase 1 & P - 2028 Background - PM  
21: Preston & Drive 1

Intersection						
Int Delay, s/veh	0					
Movement	WBL	WBR	NBT	NBR	SBL	SBT
Lane Configurations		↑↑↑	↑↑↑			↑↑↑
Traffic Vol, veh/h	0	2	2436	2	0	1842
Future Vol, veh/h	0	2	2436	2	0	1842
Conflicting Peds, #/hr	0	0	0	0	0	0
Sign Control	Stop	Stop	Free	Free	Free	Free
RT Channelized	-	None	-	None	-	None
Storage Length	-	0	-	-	-	-
Veh in Median Storage, #	0	-	0	-	0	0
Grade, %	0	-	0	-	0	0
Peak Hour Factor	95	95	95	95	95	95
Heavy Vehicles, %	2	2	2	2	2	2
Mvmt Flow	0	2	2564	2	0	1939

Major/Minor	Minor1	Major1	Major2		
Conflicting Flow All	-	1283	0	0	-
Stage 1	-	-	-	-	-
Stage 2	-	-	-	-	-
Critical Hdwy	-	7.14	-	-	-
Critical Hdwy Stg 1	-	-	-	-	-
Critical Hdwy Stg 2	-	-	-	-	-
Follow-up Hdwy	-	3.92	-	-	-
Pot Cap-1 Maneuver	0	134	-	0	-
Stage 1	0	-	-	0	-
Stage 2	0	-	-	0	-
Platoon blocked, %	-	-	-	-	-
Mov Cap-1 Maneuver	-	134	-	-	-
Mov Cap-2 Maneuver	-	-	-	-	-
Stage 1	-	-	-	-	-
Stage 2	-	-	-	-	-

Approach	WB	NB	SB
HCM Control Delay, s	32.3	0	0
HCM LOS	D		

Minor Lane/Major Mvmt	NBT	NBRWBLn1	SBT
Capacity (veh/h)	-	134	-
HCM Lane V/C Ratio	-	0.016	-
HCM Control Delay (s)	-	32.3	-
HCM Lane LOS	-	D	-
HCM 95th %tile Q(veh)	-	0	-

Pepper Square TIA  
HCM 6th TWSC

Phase 1 & P - 2028 Background - PM  
22: Drive 6 & Belt Line

Intersection						
Int Delay, s/veh	0.1					
Movement	EBT	EBR	WBL	WBT	NBL	NBR
Lane Configurations	↑↑↑			↑↑↑		↑
Traffic Vol, veh/h	1252	8	0	909	0	8
Future Vol, veh/h	1252	8	0	909	0	8
Conflicting Peds, #/hr	0	0	0	0	0	0
Sign Control	Free	Free	Free	Free	Stop	Stop
RT Channelized	-	None	-	None	-	None
Storage Length	-	-	-	-	-	0
Veh in Median Storage, #	0	-	-	0	0	-
Grade, %	0	-	-	0	0	-
Peak Hour Factor	93	93	93	93	93	93
Heavy Vehicles, %	2	2	2	2	2	2
Mvmt Flow	1346	9	0	977	0	9

Major/Minor	Major1	Major2	Minor1		
Conflicting Flow All	0	0	-	-	678
Stage 1	-	-	-	-	-
Stage 2	-	-	-	-	-
Critical Hdwy	-	-	-	-	7.14
Critical Hdwy Stg 1	-	-	-	-	-
Critical Hdwy Stg 2	-	-	-	-	-
Follow-up Hdwy	-	-	-	-	3.92
Pot Cap-1 Maneuver	-	0	0	0	338
Stage 1	-	0	0	0	-
Stage 2	-	0	0	0	-
Platoon blocked, %	-	-	-	-	-
Mov Cap-1 Maneuver	-	-	-	-	338
Mov Cap-2 Maneuver	-	-	-	-	-
Stage 1	-	-	-	-	-
Stage 2	-	-	-	-	-

Approach	EB	WB	NB
HCM Control Delay, s	0	0	15.9
HCM LOS			C

Minor Lane/Major Mvmt	NBLn1	EBT	EBR	WBT
Capacity (veh/h)	338	-	-	-
HCM Lane V/C Ratio	0.025	-	-	-
HCM Control Delay (s)	15.9	-	-	-
HCM Lane LOS	C	-	-	-
HCM 95th %tile Q(veh)	0.1	-	-	-



Pepper Square TIA  
HCM 6th TWSC

Phase 1 & P - 2028 Background - PM  
24: Drive 5 & Belt Line

Intersection						
Int Delay, s/veh	0					
Movement	EBT	EBR	WBL	WBT	NBL	NBR
Lane Configurations	↑↑↑			↑↑↑		↑
Traffic Vol, veh/h	1234	0	0	864	0	5
Future Vol, veh/h	1234	0	0	864	0	5
Conflicting Peds, #/hr	0	0	0	0	0	0
Sign Control	Free	Free	Free	Free	Stop	Stop
RT Channelized	-	None	-	None	-	None
Storage Length	-	-	-	-	-	0
Veh in Median Storage, #	0	-	-	0	0	-
Grade, %	0	-	-	0	0	-
Peak Hour Factor	93	93	93	93	93	93
Heavy Vehicles, %	2	2	2	2	2	2
Mvmt Flow	1327	0	0	929	0	5

Major/Minor	Major1	Major2	Minor1
Conflicting Flow All	0	0	- 664
Stage 1	-	-	-
Stage 2	-	-	-
Critical Hdwy	-	-	- 7.14
Critical Hdwy Stg 1	-	-	-
Critical Hdwy Stg 2	-	-	-
Follow-up Hdwy	-	-	- 3.92
Pot Cap-1 Maneuver	-	0	- 0 346
Stage 1	-	0	- 0
Stage 2	-	0	- 0
Platoon blocked, %	-	-	-
Mov Cap-1 Maneuver	-	-	- 346
Mov Cap-2 Maneuver	-	-	-
Stage 1	-	-	-
Stage 2	-	-	-

Approach	EB	WB	NB
HCM Control Delay, s	0	0	15.6
HCM LOS			C

Minor Lane/Major Mvmt	NBLn1	EBT	EBR	WBT
Capacity (veh/h)	346	-	-	-
HCM Lane V/C Ratio	0.016	-	-	-
HCM Control Delay (s)	15.6	-	-	-
HCM Lane LOS	C	-	-	-
HCM 95th %tile Q(veh)	0	-	-	-

Pepper Square TIA  
HCM 6th TWSC

Phase 1 & P - 2028 Background - PM  
25: Preston & Drive 4

Intersection						
Int Delay, s/veh	0.1					
Movement	WBL	WBR	NBT	NBR	SBL	SBT
Lane Configurations		↑↑↑	↑↑↑			↑↑↑
Traffic Vol, veh/h	0	10	2437	9	0	2005
Future Vol, veh/h	0	10	2437	9	0	2005
Conflicting Peds, #/hr	0	0	0	0	0	0
Sign Control	Stop	Stop	Free	Free	Free	Free
RT Channelized	-	None	-	None	-	None
Storage Length	-	0	-	-	-	-
Veh in Median Storage, #	0	-	0	-	-	0
Grade, %	0	-	0	-	-	0
Peak Hour Factor	95	95	95	95	95	95
Heavy Vehicles, %	2	2	2	2	2	2
Mvmt Flow	0	11	2565	9	0	2111

Major/Minor	Minor1	Major1	Major2
Conflicting Flow All	- 1287	0	0 -
Stage 1	-	-	-
Stage 2	-	-	-
Critical Hdwy	- 7.14	-	-
Critical Hdwy Stg 1	-	-	-
Critical Hdwy Stg 2	-	-	-
Follow-up Hdwy	- 3.92	-	-
Pot Cap-1 Maneuver	0	133	- - 0 -
Stage 1	0	-	- - 0 -
Stage 2	0	-	- - 0 -
Platoon blocked, %	-	-	-
Mov Cap-1 Maneuver	- 133	-	-
Mov Cap-2 Maneuver	-	-	-
Stage 1	-	-	-
Stage 2	-	-	-

Approach	WB	NB	SB
HCM Control Delay, s	34.4	0	0
HCM LOS	D		

Minor Lane/Major Mvmt	NBT	NBRWBLn1	SBT
Capacity (veh/h)	-	- 133	-
HCM Lane V/C Ratio	-	- 0.079	-
HCM Control Delay (s)	-	- 34.4	-
HCM Lane LOS	-	- D	-
HCM 95th %tile Q(veh)	-	- 0.3	-

Intersection						
Int Delay, s/veh	0.3					
Movement	WBL	WBR	NBT	NBR	SBL	SBT
Lane Configurations			↑↑↑			↑↑↑
Traffic Vol, veh/h	0	30	2437	18	0	2005
Future Vol, veh/h	0	30	2437	18	0	2005
Conflicting Peds, #/hr	0	0	0	0	0	0
Sign Control	Stop	Stop	Free	Free	Free	Free
RT Channelized	-	None	-	None	-	None
Storage Length	-	0	-	-	-	-
Veh in Median Storage, #	0	-	0	-	-	0
Grade, %	0	-	0	-	-	0
Peak Hour Factor	95	95	95	95	95	95
Heavy Vehicles, %	2	2	2	2	2	2
Mvmt Flow	0	32	2565	19	0	2111

Major/Minor	Minor1	Major1	Major2
Conflicting Flow All	-	1292	0
Stage 1	-	-	-
Stage 2	-	-	-
Critical Hdwy	-	7.14	-
Critical Hdwy Stg 1	-	-	-
Critical Hdwy Stg 2	-	-	-
Follow-up Hdwy	-	3.92	-
Pot Cap-1 Maneuver	0	132	-
Stage 1	0	-	-
Stage 2	0	-	-
Platoon blocked, %	-	-	-
Mov Cap-1 Maneuver	-	132	-
Mov Cap-2 Maneuver	-	-	-
Stage 1	-	-	-
Stage 2	-	-	-

Approach	WB	NB	SB
HCM Control Delay, s	40.6	0	0
HCM LOS	E		

Minor Lane/Major Mvmt	NBT	NBRWBLn1	SBT
Capacity (veh/h)	-	-	132
HCM Lane V/C Ratio	-	-	0.239
HCM Control Delay (s)	-	-	40.6
HCM Lane LOS	-	-	E
HCM 95th %tile Q(veh)	-	-	0.9



## **Synchro™ Output - 2028 Background Plus Site-Generated Traffic – Phases 1 and P**

Pepper Square TIA  
Lanes, Volumes, Timings

Phase 1 & P - 2028 Background + Site - AM  
4: Berry Trail & Belt Line

Lane Group	EBL	EBT	EBR	WBL	WBT	WBR	NBL	NBT	NBR	SBL	SBT	SBR
Lane Configurations	↔ ↑↑↑	↔ ↑↑↑	↔	↔ ↑↑↑	↔ ↑↑↑	↔	↔	↔	↔	↔	↔	↔
Traffic Volume (vph)	13	472	92	103	994	22	141	1	140	35	7	63
Future Volume (vph)	13	472	92	103	994	22	141	1	140	35	7	63
Ideal Flow (vphpl)	1900	1900	1900	1900	1900	1900	1900	1900	1900	1900	1900	1900
Storage Length (ft)	150		0	150		0	0		0	0		0
Storage Lanes	1		0	1		0	1		0	1		0
Taper Length (ft)	25			25			25			25		
Lane Util. Factor	1.00	0.91	0.91	1.00	0.91	0.91	1.00	1.00	1.00	1.00	1.00	1.00
Frt		0.976			0.997			0.851				0.865
Fit Protected	0.950			0.950			0.950			0.950		
Satd. Flow (prot)	1770	4963	0	1770	5070	0	1770	1585	0	1770	1611	0
Fit Permitted	0.204			0.380			0.573			0.334		
Satd. Flow (perm)	380	4963	0	708	5070	0	1067	1585	0	622	1611	0
Right Turn on Red			Yes			Yes			Yes			Yes
Satd. Flow (RTOR)		43			3			165				74
Link Speed (mph)		42			42			30				30
Link Distance (ft)		234			493			277				236
Travel Time (s)		3.8			8.0			6.3				5.4
Peak Hour Factor	0.85	0.85	0.85	0.85	0.85	0.85	0.85	0.85	0.85	0.85	0.85	0.85
Adj. Flow (vph)	15	555	108	121	1169	26	166	1	165	41	8	74
Shared Lane Traffic (%)												
Lane Group Flow (vph)	15	663	0	121	1195	0	166	166	0	41	82	0
Enter Blocked Intersection	No	No	No	No	No	No	No	No	No	No	No	No
Lane Alignment	Left	Left	Right	Left	Left	Right	Left	Left	Right	Left	Left	Right
Median Width(ft)		12			12			12				12
Link Offset(ft)		0			0			0				0
Crosswalk Width(ft)		16			16			16				16
Two way Left Turn Lane												
Headway Factor	1.00	1.00	1.00	1.00	1.00	1.00	1.00	1.00	1.00	1.00	1.00	1.00
Turning Speed (mph)	15		9	15		9	15		9	15		9
Number of Detectors	1	2		1	2		1	2		1	2	
Detector Template	Left	Thru		Left	Thru		Left	Thru		Left	Thru	
Leading Detector (ft)	20	100		20	100		20	100		20	100	
Trailing Detector (ft)	0	0		0	0		0	0		0	0	
Detector 1 Position(ft)	0	0		0	0		0	0		0	0	
Detector 1 Size(ft)	20	6		20	6		20	6		20	6	
Detector 1 Type	Cl+Ex	Cl+Ex		Cl+Ex	Cl+Ex		Cl+Ex	Cl+Ex		Cl+Ex	Cl+Ex	
Detector 1 Channel												
Detector 1 Extend (s)	0.0	0.0		0.0	0.0		0.0	0.0		0.0	0.0	
Detector 1 Queue (s)	0.0	0.0		0.0	0.0		0.0	0.0		0.0	0.0	
Detector 1 Delay (s)	0.0	0.0		0.0	0.0		0.0	0.0		0.0	0.0	
Detector 2 Position(ft)		94			94			94			94	
Detector 2 Size(ft)		6			6			6			6	
Detector 2 Type		Cl+Ex			Cl+Ex			Cl+Ex			Cl+Ex	
Detector 2 Channel												
Detector 2 Extend (s)		0.0			0.0			0.0			0.0	
Turn Type	D,P+P	NA		D,P+P	NA		D,P+P	NA		D,P+P	NA	
Protected Phases	3	8		7	4		1	6		5	2	
Permitted Phases	4			8			2			6		

Pepper Square TIA  
Lanes, Volumes, Timings

Phase 1 & P - 2028 Background + Site - AM  
4: Berry Trail & Belt Line

Lane Group	EBL	EBT	EBR	WBL	WBT	WBR	NBL	NBT	NBR	SBL	SBT	SBR
Detector Phase	3	8		7	4		1	6		5	2	
Switch Phase												
Minimum Initial (s)	4.0	4.0		4.0	4.0		4.0	4.0		4.0	4.0	
Minimum Split (s)	10.0	24.0		10.0	24.0		10.0	31.0		10.0	31.0	
Total Split (s)	15.0	99.0		15.0	99.0		25.0	31.0		15.0	21.0	
Total Split (%)	9.4%	61.9%		9.4%	61.9%		15.6%	19.4%		9.4%	13.1%	
Maximum Green (s)	9.0	93.0		9.0	93.0		19.0	25.0		9.0	15.0	
Yellow Time (s)	4.0	4.0		4.0	4.0		4.0	4.0		4.0	4.0	
All-Red Time (s)	2.0	2.0		2.0	2.0		2.0	2.0		2.0	2.0	
Lost Time Adjust (s)	0.0	0.0		0.0	0.0		0.0	0.0		0.0	0.0	
Total Lost Time (s)	6.0	6.0		6.0	6.0		6.0	6.0		6.0	6.0	
Lead/Lag	Lead	Lag		Lead	Lag		Lead	Lag		Lead	Lag	
Lead-Lag Optimize?	Yes	Yes		Yes	Yes		Yes	Yes		Yes	Yes	
Vehicle Extension (s)	1.0	1.0		1.0	1.0		1.0	1.0		1.0	1.0	
Recall Mode	None	C-Max		None	C-Max		None	None		None	None	
Walk Time (s)		4.0			4.0			4.0			4.0	
Flash Dont Walk (s)		14.0			14.0			21.0			21.0	
Pedestrian Calls (#/hr)		0			0			0			0	
Act Effct Green (s)	117.7	107.5		114.1	115.9		21.9	17.4		23.1	5.8	
Actuated g/C Ratio	0.74	0.67		0.71	0.72		0.14	0.11		0.14	0.04	
v/c Ratio	0.05	0.20		0.22	0.33		0.76	0.52		0.30	0.64	
Control Delay	8.4	10.2		2.9	2.9		81.9	14.8		59.3	39.7	
Queue Delay	0.0	0.0		0.0	0.0		0.0	0.0		0.0	0.0	
Total Delay	8.4	10.2		2.9	2.9		81.9	14.8		59.3	39.7	
LOS	A	B		A	A		F	B		E	D	
Approach Delay		10.2			2.9			48.3			46.2	
Approach LOS		B			A			D			D	
Queue Length 50th (ft)	4	59		9	35		161	1		37	8	
Queue Length 95th (ft)	m9	70		16	94		215	60		66	58	
Internal Link Dist (ft)		154			413			197			156	
Turn Bay Length (ft)	150			150								
Base Capacity (vph)	362	3348		575	3674		245	386		160	218	
Starvation Cap Reductn	0	0		0	0		0	0		0	0	
Spillback Cap Reductn	0	0		0	0		0	0		0	0	
Storage Cap Reductn	0	0		0	0		0	0		0	0	
Reduced v/c Ratio	0.04	0.20		0.21	0.33		0.68	0.43		0.26	0.38	
Intersection Summary												
Area Type:	Other											
Cycle Length:	160											
Actuated Cycle Length:	160											
Offset:	11 (7%), Referenced to phase 4:EBWB and 8:EBWB, Start of Yellow											
Natural Cycle:	75											
Control Type:	Actuated-Coordinated											
Maximum v/c Ratio:	0.76											
Intersection Signal Delay:	13.3											
Intersection Capacity Utilization:	55.1%											
ICU Level of Service:	B											
Analysis Period (min):	15											
m Volume for 95th percentile queue is metered by upstream signal.												

Pepper Square TIA  
Lanes, Volumes, Timings

Phase 1 & P - 2028 Background + Site - AM  
4: Berry Trail & Belt Line

Splits and Phases: 4: Berry Trail & Belt Line

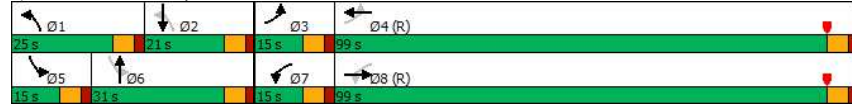

Pepper Square TIA  
Lanes, Volumes, Timings

Phase 1 & P - 2028 Background + Site - AM  
1335: Meadow Creek & Belt Line

	EBL	EBT	EBR	WBL	WBT	WBR	NBL	NBT	NBR	SBL	SBT	SBR
Lane Configurations	↑↑↑↑											
Traffic Volume (vph)	29	781	16	3	1155	18	21	3	6	8	9	82
Future Volume (vph)	29	781	16	3	1155	18	21	3	6	8	9	82
Ideal Flow (vphpl)	1900	1900	1900	1900	1900	1900	1900	1900	1900	1900	1900	1900
Storage Length (ft)	150		0	150		0	0		0	0		0
Storage Lanes	1		0	1		0	0		0	0		0
Taper Length (ft)	25			25			25			25		
Lane Util. Factor	1.00	0.91	0.91	1.00	0.91	0.91	1.00	1.00	1.00	1.00	1.00	1.00
Frt		0.997			0.998			0.975			0.889	
Fit Protected	0.950			0.950				0.965			0.996	
Satd. Flow (prot)	1770	5070	0	1770	5075	0	0	1753	0	0	1649	0
Fit Permitted	0.193			0.307				0.705			0.978	
Satd. Flow (perm)	360	5070	0	572	5075	0	0	1280	0	0	1620	0
Right Turn on Red			Yes			Yes			Yes			Yes
Satd. Flow (RTOR)		4			3			6			88	
Link Speed (mph)	42			42			30				30	
Link Distance (ft)		1673			2404		392				423	
Travel Time (s)		27.2			39.0		8.9				9.6	
Peak Hour Factor	0.93	0.93	0.93	0.93	0.93	0.93	0.93	0.93	0.93	0.93	0.93	0.93
Adj. Flow (vph)	31	840	17	3	1242	19	23	3	6	9	10	88
Shared Lane Traffic (%)												
Lane Group Flow (vph)	31	857	0	3	1261	0	0	32	0	0	107	0
Enter Blocked Intersection	No	No	No	No	No	No	No	No	No	No	No	No
Lane Alignment	Left	Left	Right	Left	Left	Right	Left	Left	Right	Left	Left	Right
Median Width(ft)		12			12			0			0	
Link Offset(ft)		0			0			0			0	
Crosswalk Width(ft)		16			16			16			16	
Two way Left Turn Lane												
Headway Factor	1.00	1.00	1.00	1.00	1.00	1.00	1.00	1.00	1.00	1.00	1.00	1.00
Turning Speed (mph)	15		9	15		9	15		9	15		9
Number of Detectors	1	1		1	1		1	1		1	1	
Detector Template												
Leading Detector (ft)	50	50		50	50		50	50		50	50	
Trailing Detector (ft)	0	0		0	0		0	0		0	0	
Detector 1 Position(ft)	0	0		0	0		0	0		0	0	
Detector 1 Size(ft)	50	50		50	50		50	50		50	50	
Detector 1 Type	Cl+Ex	Cl+Ex		Cl+Ex	Cl+Ex		Cl+Ex	Cl+Ex		Cl+Ex	Cl+Ex	
Detector 1 Channel												
Detector 1 Extend (s)	0.0	0.0		0.0	0.0		0.0	0.0		0.0	0.0	
Detector 1 Queue (s)	0.0	0.0		0.0	0.0		0.0	0.0		0.0	0.0	
Detector 1 Delay (s)	0.0	0.0		0.0	0.0		0.0	0.0		0.0	0.0	
Turn Type	Perm	NA		Perm	NA		Perm	NA		Perm	NA	
Protected Phases		6 14			2 10			4 12			4 12	
Permitted Phases	6 14			2 10		4 12				4 12		
Detector Phase	6 14	6 14		2 10	2 10		4 12	4 12		4 12	4 12	
Switch Phase												
Minimum Initial (s)												
Minimum Split (s)												
Total Split (s)												

Pepper Square TIA  
Lanes, Volumes, Timings

Phase 1 & P - 2028 Background + Site - AM  
1335: Meadow Creek & Belt Line

Lane Group	Ø2	Ø4	Ø6	Ø10	Ø12	Ø14
Lane Configurations						
Traffic Volume (vph)						
Future Volume (vph)						
Ideal Flow (vphpl)						
Storage Length (ft)						
Storage Lanes						
Taper Length (ft)						
Lane Util. Factor						
Frt						
Fit Protected						
Satd. Flow (prot)						
Fit Permitted						
Satd. Flow (perm)						
Right Turn on Red						
Satd. Flow (RTOR)						
Link Speed (mph)						
Link Distance (ft)						
Travel Time (s)						
Peak Hour Factor						
Adj. Flow (vph)						
Shared Lane Traffic (%)						
Lane Group Flow (vph)						
Enter Blocked Intersection						
Lane Alignment						
Median Width(ft)						
Link Offset(ft)						
Crosswalk Width(ft)						
Two way Left Turn Lane						
Headway Factor						
Turning Speed (mph)						
Number of Detectors						
Detector Template						
Leading Detector (ft)						
Trailing Detector (ft)						
Detector 1 Position(ft)						
Detector 1 Size(ft)						
Detector 1 Type						
Detector 1 Channel						
Detector 1 Extend (s)						
Detector 1 Queue (s)						
Detector 1 Delay (s)						
Turn Type						
Protected Phases	2	4	6	10	12	14
Permitted Phases						
Detector Phase						
Switch Phase						
Minimum Initial (s)	12.0	6.0	12.0	12.0	12.0	6.0
Minimum Split (s)	17.0	23.5	17.0	20.0	23.0	20.0
Total Split (s)	96.0	22.0	96.0	22.0	20.0	22.0

Pepper Square TIA  
Lanes, Volumes, Timings

Phase 1 & P - 2028 Background + Site - AM  
1335: Meadow Creek & Belt Line

Lane Group	EBL	EBT	EBR	WBL	WBT	WBR	NBL	NBT	NBR	SBL	SBT	SBR
Total Split (%)												
Maximum Green (s)												
Yellow Time (s)												
All-Red Time (s)												
Lost Time Adjust (s)												
Total Lost Time (s)												
Lead/Lag												
Lead-Lag Optimize?												
Vehicle Extension (s)												
Recall Mode												
Walk Time (s)												
Flash Dont Walk (s)												
Pedestrian Calls (#/hr)												
Act Effect Green (s)	122.1	122.1		122.1	122.1			21.9				21.9
Actuated g/C Ratio	0.76	0.76		0.76	0.76			0.14				0.14
v/c Ratio	0.11	0.22		0.01	0.33			0.18				0.36
Control Delay	4.4	3.2		0.3	0.3			39.7				15.3
Queue Delay	0.0	0.0		0.0	0.0			0.0				0.0
Total Delay	4.4	3.2		0.3	0.3			39.7				15.3
LOS	A	A		A	A			D				B
Approach Delay		3.3			0.3			39.7				15.3
Approach LOS		A			A			D				B
Queue Length 50th (ft)	6	63		0	6			21				15
Queue Length 95th (ft)	14	73		m0	m5			48				62
Internal Link Dist (ft)		1593			2324			312				343
Turn Bay Length (ft)	150			150								
Base Capacity (vph)	284	4007		452	4011			276				413
Starvation Cap Reductn	0	0		0	0			0				0
Spillback Cap Reductn	0	0		0	0			0				0
Storage Cap Reductn	0	0		0	0			0				0
Reduced v/c Ratio	0.11	0.21		0.01	0.31			0.12				0.26

**Intersection Summary**  
 Area Type: Other  
 Cycle Length: 160  
 Actuated Cycle Length: 160  
 Offset: 82 (51%), Referenced to phase 2:WBTl and 6:EBTL, Start of Yellow  
 Natural Cycle: 85  
 Control Type: Actuated-Coordinated  
 Maximum v/c Ratio: 0.36  
 Intersection Signal Delay: 2.7 Intersection LOS: A  
 Intersection Capacity Utilization 39.1% ICU Level of Service A  
 Analysis Period (min) 15  
 m Volume for 95th percentile queue is metered by upstream signal.

Splits and Phases: 1335: Meadow Creek & Belt Line

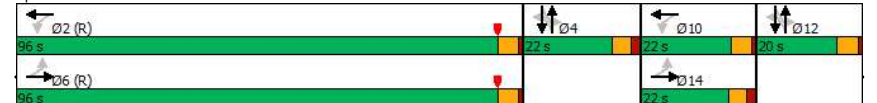

Pepper Square TIA  
Lanes, Volumes, Timings

Phase 1 & P - 2028 Background + Site - AM  
1335: Meadow Creek & Belt Line

Lane Group	Ø2	Ø4	Ø6	Ø10	Ø12	Ø14
Total Split (%)	60%	14%	60%	14%	13%	14%
Maximum Green (s)	91.0	16.5	91.0	17.0	15.0	16.5
Yellow Time (s)	4.0	3.7	4.0	4.0	4.0	3.7
All-Red Time (s)	1.0	1.8	1.0	1.0	1.0	1.8
Lost Time Adjust (s)						
Total Lost Time (s)						
Lead/Lag						
Lead-Lag Optimize?						
Vehicle Extension (s)	2.0	1.8	2.0	2.0	1.8	2.0
Recall Mode	C-Max	None	C-Min	None	None	None
Walk Time (s)	4.0	4.0	4.0	4.0	4.0	4.0
Flash Dont Walk (s)	8.0	14.0	8.0	8.0	14.0	8.0
Pedestrian Calls (#/hr)	0	0	0	0	0	0
Act Effect Green (s)						
Actuated g/C Ratio						
v/c Ratio						
Control Delay						
Queue Delay						
Total Delay						
LOS						
Approach Delay						
Approach LOS						
Queue Length 50th (ft)						
Queue Length 95th (ft)						
Internal Link Dist (ft)						
Turn Bay Length (ft)						
Base Capacity (vph)						
Starvation Cap Reductn						
Spillback Cap Reductn						
Storage Cap Reductn						
Reduced v/c Ratio						

Intersection Summary

Pepper Square TIA  
Lanes, Volumes, Timings

Phase 1 & P - 2028 Background + Site - AM  
1365: Preston & Arapah

Lane Group	EBU	EBL	EBT	EBR	WBL	WBT	WBR	NBU	NBL	NBT	NBR	SBU
Lane Configurations		↑↑	↑↑↑		↑↑	↑↑↑			↑↑	↑↑↑		
Traffic Volume (vph)	3	138	271	160	133	741	170	1	145	1745	113	4
Future Volume (vph)	3	138	271	160	133	741	170	1	145	1745	113	4
Ideal Flow (vphpl)	1900	1900	1900	1900	1900	1900	1900	1900	1900	1900	1900	1900
Storage Length (ft)		150		0	150		0		300		0	
Storage Lanes		2		0	2		0		2		0	
Taper Length (ft)		25			25				25			
Lane Util. Factor	0.91	0.97	0.91	0.91	0.97	0.91	0.91	0.91	0.97	0.91	0.91	0.91
Frt			0.944		0.972					0.991		
Fit Protected		0.950			0.950				0.950			
Satd. Flow (prot)	0	3433	4801	0	3433	4943	0	0	3433	5040	0	0
Fit Permitted		0.950			0.950				0.950			
Satd. Flow (perm)	0	3433	4801	0	3433	4943	0	0	3433	5040	0	0
Right Turn on Red			Yes			Yes				Yes		
Satd. Flow (RTOR)			88			32				8		
Link Speed (mph)			42			42				42		
Link Distance (ft)			1672			1942				3054		
Travel Time (s)			27.1			31.5				49.6		
Peak Hour Factor	0.95	0.95	0.95	0.95	0.95	0.95	0.95	0.95	0.95	0.95	0.95	0.95
Adj. Flow (vph)	3	145	285	168	140	780	179	1	153	1837	119	4
Shared Lane Traffic (%)												
Lane Group Flow (vph)	0	148	453	0	140	959	0	0	154	1956	0	0
Enter Blocked Intersection	No	No	No	No	No	No	No	No	No	No	No	No
Lane Alignment	R NA	Left	Left	Right	Left	Left	Right	R NA	Left	Left	Right	R NA
Median Width(ft)			24			24				24		
Link Offset(ft)			0			0				0		
Crosswalk Width(ft)			16			16				16		
Two way Left Turn Lane												
Headway Factor	1.00	1.00	1.00	1.00	1.00	1.00	1.00	1.00	1.00	1.00	1.00	1.00
Turning Speed (mph)	9	15		9	15		9	9	15		9	9
Number of Detectors	1	1	1		1	1		1	1	1		1
Detector Template												
Leading Detector (ft)	50	50	50		50	50		50	50	50		50
Trailing Detector (ft)	0	0	0		0	0		0	0	0		0
Detector 1 Position(ft)	0	0	0		0	0		0	0	0		0
Detector 1 Size(ft)	50	50	50		50	50		50	50	50		50
Detector 1 Type	CI+Ex	CI+Ex	CI+Ex		CI+Ex	CI+Ex		CI+Ex	CI+Ex	CI+Ex		CI+Ex
Detector 1 Channel												
Detector 1 Extend (s)	0.0	0.0	0.0		0.0	0.0		0.0	0.0	0.0		0.0
Detector 1 Queue (s)	0.0	0.0	0.0		0.0	0.0		0.0	0.0	0.0		0.0
Detector 1 Delay (s)	0.0	0.0	0.0		0.0	0.0		0.0	0.0	0.0		0.0
Turn Type	Prot	Prot	NA		Prot	NA		Prot	Prot	NA		Prot
Protected Phases	3	3	8		7	4		1	1	6		5
Permitted Phases												
Detector Phase	3	3	8		7	4		1	1	6		5
Switch Phase												
Minimum Initial (s)	3.0	3.0	18.0		3.0	18.0		3.0	3.0	18.0		3.0
Minimum Split (s)	10.0	10.0	36.7		21.0	36.3		10.0	10.0	35.7		10.0
Total Split (s)	13.0	13.0	44.0		18.0	49.0		14.0	14.0	78.0		20.0

Pepper Square TIA  
Lanes, Volumes, Timings

Phase 1 & P - 2028 Background + Site - AM  
1365: Preston & Arapaho

Lane Group	SBL	SBT	SBR
Lane Configurations	↑↑	↑↑↑	
Traffic Volume (vph)	101	1865	219
Future Volume (vph)	101	1865	219
Ideal Flow (vphpl)	1900	1900	1900
Storage Length (ft)	250		0
Storage Lanes	2		0
Taper Length (ft)	25		
Lane Util. Factor	0.97	0.91	0.91
Frt		0.984	
Fit Protected	0.950		
Satd. Flow (prot)	3433	5004	0
Fit Permitted	0.950		
Satd. Flow (perm)	3433	5004	0
Right Turn on Red			Yes
Satd. Flow (RTOR)		18	
Link Speed (mph)		48	
Link Distance (ft)		5087	
Travel Time (s)		72.3	
Peak Hour Factor	0.95	0.95	0.95
Adj. Flow (vph)	106	1963	231
Shared Lane Traffic (%)			
Lane Group Flow (vph)	110	2194	0
Enter Blocked Intersection	No	No	No
Lane Alignment	Left	Left	Right
Median Width(ft)		24	
Link Offset(ft)		0	
Crosswalk Width(ft)		16	
Two way Left Turn Lane			
Headway Factor	1.00	1.00	1.00
Turning Speed (mph)	15		9
Number of Detectors	1	1	
Detector Template			
Leading Detector (ft)	50	50	
Trailing Detector (ft)	0	0	
Detector 1 Position(ft)	0	0	
Detector 1 Size(ft)	50	50	
Detector 1 Type	CI+Ex	CI+Ex	
Detector 1 Channel			
Detector 1 Extend (s)	0.0	0.0	
Detector 1 Queue (s)	0.0	0.0	
Detector 1 Delay (s)	0.0	0.0	
Turn Type	Prot	NA	
Protected Phases	5	2	
Permitted Phases			
Detector Phase	5	2	
Switch Phase			
Minimum Initial (s)	3.0	18.0	
Minimum Split (s)	10.0	37.7	
Total Split (s)	20.0	84.0	

09/26/2022 4:54 pm  
Kimley-Horn

Synchro 11 Report  
Page 9

Pepper Square TIA  
Lanes, Volumes, Timings

Phase 1 & P - 2028 Background + Site - AM  
1365: Preston & Arapaho

Lane Group	EBU	EBL	EBT	EBR	WBL	WBT	WBR	NBU	NBL	NBT	NBR	SBU
Total Split (%)	8.1%	8.1%	27.5%		11.3%	30.6%		8.8%	8.8%	48.8%		12.5%
Maximum Green (s)	7.5	7.5	38.7		12.5	43.7		8.5	8.5	72.3		14.5
Yellow Time (s)	3.0	3.0	4.3		3.0	4.3		3.0	3.0	4.7		3.0
All-Red Time (s)	2.5	2.5	1.0		2.5	1.0		2.5	2.5	1.0		2.5
Lost Time Adjust (s)		-1.0	-1.4		-1.0	-1.0			-1.0	-1.7		
Total Lost Time (s)		4.5	3.9		4.5	4.3			4.5	4.0		
Lead/Lag	Lead	Lead	Lag		Lead	Lag		Lead	Lead	Lead		Lag
Lead-Lag Optimize?	Yes	Yes	Yes		Yes	Yes		Yes	Yes	Yes		Yes
Vehicle Extension (s)	0.8	0.8	2.5		0.8	1.8		1.5	1.5	1.7		1.5
Recall Mode	None	None	Max		None	None		None	None	Max		None
Walk Time (s)			4.0			4.0				4.0		
Flash Dont Walk (s)			27.0			27.0				26.0		
Pedestrian Calls (#/hr)			0			0				0		
Act Effect Green (s)		8.4	43.0		10.6	44.8			9.4	74.0		
Actuated g/C Ratio		0.05	0.27		0.07	0.28			0.06	0.46		
v/c Ratio		0.82	0.33		0.61	0.68			0.77	0.84		
Control Delay		104.4	37.9		79.3	62.3			92.7	26.7		
Queue Delay		0.0	0.0		0.0	0.0			0.0	0.0		
Total Delay		104.4	37.9		79.3	62.3			92.7	26.7		
LOS		F	D		E	E			F	C		
Approach Delay			54.3			64.5				31.5		
Approach LOS			D			E				C		
Queue Length 50th (ft)		80	113		75	359			75	729		
Queue Length 95th (ft)		#143	147		112	423			m105	773		
Internal Link Dist (ft)			1592			1862				2974		
Turn Bay Length (ft)		150			150				300			
Base Capacity (vph)		182	1353		289	1406			203	2335		
Starvation Cap Reductn		0	0		0	0			0	0		
Spillback Cap Reductn		0	0		0	0			0	0		
Storage Cap Reductn		0	0		0	0			0	0		
Reduced v/c Ratio		0.81	0.33		0.48	0.68			0.76	0.84		

Intersection Summary

Area Type: Other  
 Cycle Length: 160  
 Actuated Cycle Length: 160  
 Offset: 11 (7%), Referenced to phase 2:SBT, Start of Yellow  
 Natural Cycle: 130  
 Control Type: Actuated-Coordinated  
 Maximum v/c Ratio: 0.87  
 Intersection Signal Delay: 46.0  
 Intersection LOS: D  
 Intersection Capacity Utilization 81.6%  
 ICU Level of Service D  
 Analysis Period (min) 15  
 # 95th percentile volume exceeds capacity, queue may be longer.  
 Queue shown is maximum after two cycles.  
 m Volume for 95th percentile queue is metered by upstream signal.

Splits and Phases: 1365: Preston & Arapaho

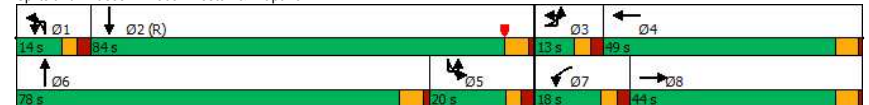



Pepper Square TIA  
Lanes, Volumes, Timings

Phase 1 & P - 2028 Background + Site - AM  
1365: Preston & Arapaho

Lane Group	SBL	SBT	SBR
Total Split (%)	12.5%	52.5%	
Maximum Green (s)	14.5	78.3	
Yellow Time (s)	3.0	4.7	
All-Red Time (s)	2.5	1.0	
Lost Time Adjust (s)	-1.0	-1.7	
Total Lost Time (s)	4.5	4.0	
Lead/Lag	Lag	Lag	
Lead-Lag Optimize?	Yes	Yes	
Vehicle Extension (s)	1.5	1.5	
Recall Mode	None	C-Max	
Walk Time (s)		4.0	
Flash Dont Walk (s)		28.0	
Pedestrian Calls (#/hr)		0	
Act Effect Green (s)	15.5	80.1	
Actuated g/C Ratio	0.10	0.50	
v/c Ratio	0.33	0.87	
Control Delay	79.1	46.8	
Queue Delay	0.0	0.0	
Total Delay	79.1	46.8	
LOS	E	D	
Approach Delay		48.3	
Approach LOS		D	
Queue Length 50th (ft)	56	782	
Queue Length 95th (ft)	m70	867	
Internal Link Dist (ft)		5007	
Turn Bay Length (ft)	250		
Base Capacity (vph)	332	2515	
Starvation Cap Reductn	0	0	
Spillback Cap Reductn	0	0	
Storage Cap Reductn	0	0	
Reduced v/c Ratio	0.33	0.87	

Intersection Summary

Pepper Square TIA  
Lanes, Volumes, Timings

Phase 1 & P - 2028 Background + Site - AM  
1367: Preston & Belt Line

Lane Group	EBU	EBL	EBT	EBR	WBL	WBT	WBR	NBL	NBT	NBR	SBU	SBL
Lane Configurations		↔	↔↔	↔	↔	↔↔	↔	↔↔	↔	↔	↔	↔
Traffic Volume (vph)	10	154	429	247	85	886	159	305	1646	22	2	160
Future Volume (vph)	10	154	429	247	85	886	159	305	1646	22	2	160
Ideal Flow (vphpl)	1900	1900	1900	1900	1900	1900	1900	1900	1900	1900	1900	1900
Storage Length (ft)		150		150	200		0	250		0		200
Storage Lanes		2		1	1		0	2		0		1
Taper Length (ft)		25			25			25				25
Lane Util. Factor	0.91	0.97	0.91	1.00	1.00	0.91	0.91	0.97	0.91	0.91	0.91	1.00
Frt			0.850		0.977			0.998				
Fit Protected		0.950		0.950			0.950					0.950
Satd. Flow (prot)	0	3433	5085	1583	1770	4968	0	3433	5075	0	0	1770
Fit Permitted		0.950		0.950			0.950					0.950
Satd. Flow (perm)	0	3433	5085	1583	1770	4968	0	3433	5075	0	0	1770
Right Turn on Red				Yes			Yes			Yes		
Satd. Flow (RTOR)				192			22			2		
Link Speed (mph)			42			42			42			
Link Distance (ft)			925			394			261			
Travel Time (s)			15.0			6.4			4.2			
Peak Hour Factor	0.95	0.95	0.95	0.95	0.95	0.95	0.95	0.95	0.95	0.95	0.95	0.95
Adj. Flow (vph)	11	162	452	260	89	933	167	321	1733	23	2	168
Shared Lane Traffic (%)												
Lane Group Flow (vph)	0	173	452	260	89	1100	0	321	1756	0	0	170
Enter Blocked Intersection	No	No	No	No	No	No	No	No	No	No	No	No
Lane Alignment	R NA	Left	Left	Right	Left	Left	Right	Left	Left	Right	R NA	Left
Median Width(ft)			24			24			24			
Link Offset(ft)			0			0			0			
Crosswalk Width(ft)				16		16			16			
Two way Left Turn Lane												
Headway Factor	1.00	1.00	1.00	1.00	1.00	1.00	1.00	1.00	1.00	1.00	1.00	1.00
Turning Speed (mph)	9	15		9	15		9	15		9	9	15
Number of Detectors	1	1	1	1	1	1	1	1	1	1	1	1
Detector Template												
Leading Detector (ft)	50	50	50	50	50	50		50	50		50	50
Trailing Detector (ft)	0	0	0	0	0	0		0	0		0	0
Detector 1 Position(ft)	0	0	0	0	0	0		0	0		0	0
Detector 1 Size(ft)	50	50	50	50	50	50		50	50		50	50
Detector 1 Type	CI+Ex	CI+Ex	CI+Ex	CI+Ex	CI+Ex	CI+Ex		CI+Ex	CI+Ex		CI+Ex	CI+Ex
Detector 1 Channel												
Detector 1 Extend (s)	0.0	0.0	0.0	0.0	0.0	0.0		0.0	0.0		0.0	0.0
Detector 1 Queue (s)	0.0	0.0	0.0	0.0	0.0	0.0		0.0	0.0		0.0	0.0
Detector 1 Delay (s)	0.0	0.0	0.0	0.0	0.0	0.0		0.0	0.0		0.0	0.0
Turn Type	Prot	Prot	NA	Perm	Prot	NA		Prot	NA		Prot	Prot
Protected Phases	3	3	8		7	4		1	6		5	5
Permitted Phases				8								
Detector Phase	3	3	8	8	7	4		1	6		5	5
Switch Phase												
Minimum Initial (s)	3.0	3.0	18.0	18.0	3.0	18.0		3.0	18.0		3.0	3.0
Minimum Split (s)	11.0	11.0	32.5	32.5	8.0	32.5		8.0	33.0		11.0	11.0
Total Split (s)	16.0	16.0	42.0	42.0	20.0	46.0		18.0	76.0		22.0	22.0

Pepper Square TIA  
Lanes, Volumes, Timings

Phase 1 & P - 2028 Background + Site - AM  
1367: Preston & Belt Line

Lane Group	SBT	SBR
Lane Configurations	↑↑↑	↑
Traffic Volume (vph)	1812	252
Future Volume (vph)	1812	252
Ideal Flow (vphpl)	1900	1900
Storage Length (ft)	300	
Storage Lanes	1	
Taper Length (ft)		
Lane Util. Factor	0.91	1.00
Frt	0.850	
Fit Protected		
Satd. Flow (prot)	5085	1583
Fit Permitted		
Satd. Flow (perm)	5085	1583
Right Turn on Red	Yes	
Satd. Flow (RTOR)	178	
Link Speed (mph)	40	
Link Distance (ft)	3054	
Travel Time (s)	52.1	
Peak Hour Factor	0.95	0.95
Adj. Flow (vph)	1907	265
Shared Lane Traffic (%)		
Lane Group Flow (vph)	1907	265
Enter Blocked Intersection	No	No
Lane Alignment	Left	Right
Median Width(ft)	24	
Link Offset(ft)	0	
Crosswalk Width(ft)	16	
Two way Left Turn Lane		
Headway Factor	1.00	1.00
Turning Speed (mph)	9	
Number of Detectors	1	1
Detector Template		
Leading Detector (ft)	50	50
Trailing Detector (ft)	0	0
Detector 1 Position(ft)	0	0
Detector 1 Size(ft)	50	50
Detector 1 Type	CI+Ex	CI+Ex
Detector 1 Channel		
Detector 1 Extend (s)	0.0	0.0
Detector 1 Queue (s)	0.0	0.0
Detector 1 Delay (s)	0.0	0.0
Turn Type	NA	Perm
Protected Phases	2	
Permitted Phases	2	
Detector Phase	2	2
Switch Phase		
Minimum Initial (s)	18.0	18.0
Minimum Split (s)	33.0	33.0
Total Split (s)	80.0	80.0

Pepper Square TIA  
Lanes, Volumes, Timings

Phase 1 & P - 2028 Background + Site - AM  
1367: Preston & Belt Line

Lane Group	EBU	EBL	EBT	EBR	WBL	WBT	WBR	NBL	NBT	NBR	SBU	SBL
Total Split (%)	10.0%	10.0%	26.3%	26.3%	12.5%	28.8%		11.3%	47.5%		13.8%	13.8%
Maximum Green (s)	11.0	11.0	36.5	36.5	15.0	40.5		13.0	70.0		17.0	17.0
Yellow Time (s)	3.0	3.0	4.0	4.0	3.0	4.0		3.0	4.4		3.0	3.0
All-Red Time (s)	2.0	2.0	1.5	1.5	2.0	1.5		2.0	1.6		2.0	2.0
Lost Time Adjust (s)		-1.0	-1.5	-1.5	-1.0	-1.5		-1.0	-1.7			-1.0
Total Lost Time (s)		4.0	4.0	4.0	4.0	4.0		4.0	4.3			4.0
Lead/Lag	Lead	Lead	Lead	Lead	Lag	Lag		Lag	Lag		Lead	Lead
Lead-Lag Optimize?	Yes	Yes	Yes	Yes	Yes	Yes		Yes	Yes		Yes	Yes
Vehicle Extension (s)	1.3	1.3	1.3	1.3	1.0	1.3		1.6	2.0		1.5	1.5
Recall Mode	None	None	Max	Max	None	Max		None	C-Max		None	None
Walk Time (s)			7.0	7.0		7.0			7.0			
Flash Dont Walk (s)			20.0	20.0		20.0			20.0			
Pedestrian Calls (#/hr)			0	0		0			0			
Act Effect Green (s)		11.3	38.0	38.0	16.0	42.7		14.0	72.4			17.3
Actuated g/C Ratio		0.07	0.24	0.24	0.10	0.27		0.09	0.45			0.11
v/c Ratio		0.72	0.37	0.50	0.50	0.82		1.07	0.76			0.89
Control Delay		75.5	41.9	13.3	53.2	34.5		123.0	27.7			110.8
Queue Delay		0.0	0.0	0.0	0.0	0.0		0.0	34.9			0.0
Total Delay		75.5	41.9	13.3	53.2	34.5		123.0	62.6			110.8
LOS		E	D	B	D	C		F	E			F
Approach Delay			40.1			35.9			71.9			
Approach LOS			D			D			E			
Queue Length 50th (ft)		93	153	96	90	379		~196	709			163
Queue Length 95th (ft)		136	192	186	m161	476		#303	679			m#212
Internal Link Dist (ft)			845			314			181			
Turn Bay Length (ft)		150		150	200			250				200
Base Capacity (vph)		257	1207	522	177	1343		300	2296			199
Starvation Cap Reductn		0	0	0	0	0		0	654			0
Spillback Cap Reductn		0	0	0	0	0		0	0			0
Storage Cap Reductn		0	0	0	0	0		0	0			0
Reduced v/c Ratio		0.67	0.37	0.50	0.50	0.82		1.07	1.07			0.85
Intersection Summary												
Area Type:	Other											
Cycle Length:	160											
Actuated Cycle Length:	160											
Offset:	81 (51%), Referenced to phase 6:NBT, Start of Yellow											
Natural Cycle:	90											
Control Type:	Actuated-Coordinated											
Maximum v/c Ratio:	1.07											
Intersection Signal Delay:	42.4						Intersection LOS: D					
Intersection Capacity Utilization:	82.6%						ICU Level of Service E					
Analysis Period (min)	15											
~	Volume exceeds capacity, queue is theoretically infinite. Queue shown is maximum after two cycles.											
#	95th percentile volume exceeds capacity, queue may be longer. Queue shown is maximum after two cycles.											
m	Volume for 95th percentile queue is metered by upstream signal.											

Pepper Square TIA  
Lanes, Volumes, Timings

Phase 1 & P - 2028 Background + Site - AM  
1367: Preston & Belt Line

Splits and Phases: 1367: Preston & Belt Line

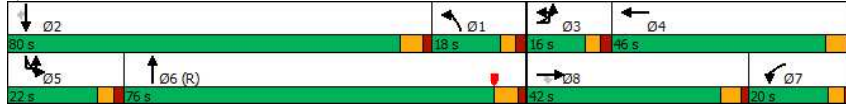

Pepper Square TIA  
Lanes, Volumes, Timings

Phase 1 & P - 2028 Background + Site - AM  
1367: Preston & Belt Line

Lane Group	SBT	SBR
Total Split (%)	50.0%	50.0%
Maximum Green (s)	74.0	74.0
Yellow Time (s)	4.4	4.4
All-Red Time (s)	1.6	1.6
Lost Time Adjust (s)	-1.7	-1.7
Total Lost Time (s)	4.3	4.3
Lead/Lag	Lead	Lead
Lead-Lag Optimize?	Yes	Yes
Vehicle Extension (s)	2.5	2.5
Recall Mode	Max	Max
Walk Time (s)	7.0	7.0
Flash Dont Walk (s)	20.0	20.0
Pedestrian Calls (#/hr)	0	0
Act Effct Green (s)	75.7	75.7
Actuated g/C Ratio	0.47	0.47
v/c Ratio	0.79	0.31
Control Delay	15.0	1.1
Queue Delay	0.0	0.0
Total Delay	15.0	1.1
LOS	B	A
Approach Delay	20.4	
Approach LOS	C	
Queue Length 50th (ft)	358	1
Queue Length 95th (ft)	334	m4
Internal Link Dist (ft)	2974	
Turn Bay Length (ft)		300
Base Capacity (vph)	2405	842
Starvation Cap Reductn	0	0
Spillback Cap Reductn	0	0
Storage Cap Reductn	0	0
Reduced v/c Ratio	0.79	0.31
<b>Intersection Summary</b>		

Pepper Square TIA  
Lanes, Volumes, Timings

Phase 1 & P - 2028 Background + Site - AM  
1368: Preston & Alexis

Lane Group	EBL	EBT	EBR	WBL	WBT	WBR	NBU	NBL	NBT	NBR	SBL	SBT
Lane Configurations	↔	↔	↔	↔	↔	↔	↔	↔	↔	↔	↔	↔
Traffic Volume (vph)	16	5	28	245	22	95	3	21	1914	131	102	1998
Future Volume (vph)	16	5	28	245	22	95	3	21	1914	131	102	1998
Ideal Flow (vphpl)	1900	1900	1900	1900	1900	1900	1900	1900	1900	1900	1900	1900
Storage Length (ft)	0		0	175		0		150		150	150	
Storage Lanes	1		1	2		1		1		1	1	
Taper Length (ft)	25			25				25			25	
Lane Util. Factor	0.91	0.91	1.00	0.97	1.00	1.00	0.91	1.00	0.91	1.00	1.00	0.91
Frt			0.850			0.850				0.850		
Fit Protected	0.950	0.969		0.950				0.950			0.950	
Satd. Flow (prot)	1610	3285	1583	3433	1863	1583	0	1770	5085	1583	1770	5085
Fit Permitted	0.950	0.969		0.950				0.058			0.059	
Satd. Flow (perm)	1610	3285	1583	3433	1863	1583	0	108	5085	1583	110	5085
Right Turn on Red			Yes			Yes				Yes		
Satd. Flow (RTOR)			125			85				89		
Link Speed (mph)	30				30				43			42
Link Distance (ft)	660				627				2867			173
Travel Time (s)	15.0				14.3				45.5			2.8
Peak Hour Factor	0.92	0.92	0.92	0.92	0.92	0.92	0.92	0.92	0.92	0.92	0.92	0.92
Adj. Flow (vph)	17	5	30	266	24	103	3	23	2080	142	111	2172
Shared Lane Traffic (%)	50%											
Lane Group Flow (vph)	8	14	30	266	24	103	0	26	2080	142	111	2172
Enter Blocked Intersection	No	No	No	No	No	No	No	No	No	No	No	No
Lane Alignment	Left	Left	Right	Left	Left	Right	R NA	Left	Left	Right	Left	Left
Median Width(ft)	24			24				12			12	
Link Offset(ft)	0			0				0			0	
Crosswalk Width(ft)	16			16				16			16	
Two way Left Turn Lane												
Headway Factor	1.00	1.00	1.00	1.00	1.00	1.00	1.00	1.00	1.00	1.00	1.00	1.00
Turning Speed (mph)	15		9	15		9	9	15		9	15	
Number of Detectors	1	1	1	1	1	1	1	1	1	1	1	1
Detector Template												
Leading Detector (ft)	50	50	50	50	50	50	50	50	50	50	50	50
Trailing Detector (ft)	0	0	0	0	0	0	0	0	0	0	0	0
Detector 1 Position(ft)	0	0	0	0	0	0	0	0	0	0	0	0
Detector 1 Size(ft)	50	50	50	50	50	50	50	50	50	50	50	50
Detector 1 Type	Cl+Ex	Cl+Ex	Cl+Ex	Cl+Ex	Cl+Ex	Cl+Ex	Cl+Ex	Cl+Ex	Cl+Ex	Cl+Ex	Cl+Ex	Cl+Ex
Detector 1 Channel												
Detector 1 Extend (s)	0.0	0.0	0.0	0.0	0.0	0.0	0.0	0.0	0.0	0.0	0.0	0.0
Detector 1 Queue (s)	0.0	0.0	0.0	0.0	0.0	0.0	0.0	0.0	0.0	0.0	0.0	0.0
Detector 1 Delay (s)	0.0	0.0	0.0	0.0	0.0	0.0	0.0	0.0	0.0	0.0	0.0	0.0
Turn Type	Split	NA	Perm	Split	NA	pm+ov	custom	D.P+P	NA	Perm	D.P+P	NA
Protected Phases	3	3		4	4	5		1	6		5	2
Permitted Phases			3			4	1	2		6		6
Detector Phase	3	3	3	4	4	5	1	1	6	6	5	2
Switch Phase												
Minimum Initial (s)	6.0	6.0	6.0	8.0	8.0	3.0	3.0	3.0	14.0	14.0	3.0	14.0
Minimum Split (s)	27.0	27.0	27.0	27.0	27.0	8.4	8.4	8.4	24.0	24.0	8.4	24.0
Total Split (s)	13.0	13.0	13.0	29.0	29.0	15.0	18.0	18.0	103.0	103.0	15.0	100.0

Pepper Square TIA  
Lanes, Volumes, Timings

Phase 1 & P - 2028 Background + Site - AM  
1368: Preston & Alexis

Lane Group	SBR
Lane Configurations	↔
Traffic Volume (vph)	23
Future Volume (vph)	23
Ideal Flow (vphpl)	1900
Storage Length (ft)	150
Storage Lanes	1
Taper Length (ft)	
Lane Util. Factor	1.00
Frt	0.850
Fit Protected	
Satd. Flow (prot)	1583
Fit Permitted	
Satd. Flow (perm)	1583
Right Turn on Red	Yes
Satd. Flow (RTOR)	78
Link Speed (mph)	
Link Distance (ft)	
Travel Time (s)	
Peak Hour Factor	0.92
Adj. Flow (vph)	25
Shared Lane Traffic (%)	
Lane Group Flow (vph)	25
Enter Blocked Intersection	No
Lane Alignment	Right
Median Width(ft)	
Link Offset(ft)	
Crosswalk Width(ft)	
Two way Left Turn Lane	
Headway Factor	1.00
Turning Speed (mph)	9
Number of Detectors	1
Detector Template	
Leading Detector (ft)	50
Trailing Detector (ft)	0
Detector 1 Position(ft)	0
Detector 1 Size(ft)	50
Detector 1 Type	Cl+Ex
Detector 1 Channel	
Detector 1 Extend (s)	0.0
Detector 1 Queue (s)	0.0
Detector 1 Delay (s)	0.0
Turn Type	Perm
Protected Phases	
Permitted Phases	2
Detector Phase	2
Switch Phase	
Minimum Initial (s)	14.0
Minimum Split (s)	24.0
Total Split (s)	100.0

Pepper Square TIA  
Lanes, Volumes, Timings

Phase 1 & P - 2028 Background + Site - AM  
1368: Preston & Alexis

Lane Group	EBL	EBT	EBR	WBL	WBT	WBR	NBU	NBL	NBT	NBR	SBL	SBT
Total Split (%)	8.1%	8.1%	8.1%	18.1%	18.1%	9.4%	11.3%	11.3%	64.4%	64.4%	9.4%	62.5%
Maximum Green (s)	8.0	8.0	8.0	24.0	24.0	10.6	13.6	13.6	97.0	97.0	10.6	94.0
Yellow Time (s)	4.0	4.0	4.0	4.0	4.0	3.4	3.4	3.4	4.5	4.5	3.4	4.5
All-Red Time (s)	1.0	1.0	1.0	1.0	1.0	1.0	1.0	1.0	1.5	1.5	1.0	1.5
Lost Time Adjust (s)	-1.0	-1.0	0.0	-1.0	-1.0	0.0			-1.0	-2.0	0.0	-2.0
Total Lost Time (s)	4.0	4.0	5.0	4.0	4.0	4.4			3.4	4.0	6.0	3.4
Lead/Lag	Lead	Lead	Lead	Lag	Lag	Lag	Lead	Lead	Lead	Lead	Lag	Lag
Lead-Lag Optimize?	Yes	Yes	Yes	Yes	Yes	Yes	Yes	Yes	Yes	Yes	Yes	Yes
Vehicle Extension (s)	2.0	2.0	2.0	2.0	2.0	1.2	1.2	1.2	2.5	2.5	1.2	2.5
Recall Mode	None	None	None	None	None	None	None	None	Max	Max	None	C-Max
Walk Time (s)	4.0	4.0	4.0	4.0	4.0				4.0	4.0		4.0
Flash Dont Walk (s)	18.0	18.0	18.0	18.0	18.0				14.0	14.0		14.0
Pedestrian Calls (#/hr)	0	0	0	0	0				0	0		0
Act Effect Green (s)	7.2	7.2	6.2	17.7	17.7	28.8		123.8	110.3	108.3	122.5	119.9
Actuated g/C Ratio	0.04	0.04	0.04	0.11	0.11	0.18		0.77	0.69	0.68	0.77	0.75
v/c Ratio	0.11	0.10	0.17	0.70	0.12	0.29		0.19	0.59	0.13	0.54	0.57
Control Delay	76.7	74.6	2.0	78.4	63.7	13.7		6.4	7.6	1.1	26.3	2.6
Queue Delay	0.0	0.0	0.0	0.0	0.0	0.0		0.0	0.0	0.0	0.0	0.0
Total Delay	76.7	74.6	2.0	78.4	63.7	13.7		6.4	7.6	1.1	26.3	2.6
LOS	E	E	A	E	E	B		A	A	A	C	A
Approach Delay		33.0			60.5				7.2			3.7
Approach LOS		C			E				A			A
Queue Length 50th (ft)	8	7	0	140	23	14		3	251	0	41	67
Queue Length 95th (ft)	30	21	0	186	53	61		7	257	9	102	74
Internal Link Dist (ft)		580			547				2787			93
Turn Bay Length (ft)				175				150		150	150	
Base Capacity (vph)	90	184	197	536	291	355		236	3504	1100	204	3810
Starvation Cap Reductn	0	0	0	0	0	0		0	0	0	0	218
Spillback Cap Reductn	0	0	0	0	0	0		0	0	0	0	0
Storage Cap Reductn	0	0	0	0	0	0		0	0	0	0	0
Reduced v/c Ratio	0.09	0.08	0.15	0.50	0.08	0.29		0.11	0.59	0.13	0.54	0.60

Intersection Summary

Area Type: Other  
 Cycle Length: 160  
 Actuated Cycle Length: 160  
 Offset: 89 (56%), Referenced to phase 2:NBSB, Start of Yellow  
 Natural Cycle: 110  
 Control Type: Actuated-Coordinated  
 Maximum v/c Ratio: 0.70  
 Intersection Signal Delay: 10.1 Intersection LOS: B  
 Intersection Capacity Utilization 68.1% ICU Level of Service C  
 Analysis Period (min) 15  
 m Volume for 95th percentile queue is metered by upstream signal.

Splits and Phases: 1368: Preston & Alexis



Pepper Square TIA  
Lanes, Volumes, Timings

Phase 1 & P - 2028 Background + Site - AM  
1368: Preston & Alexis

Lane Group	SBR
Total Split (%)	62.5%
Maximum Green (s)	94.0
Yellow Time (s)	4.5
All-Red Time (s)	1.5
Lost Time Adjust (s)	0.0
Total Lost Time (s)	6.0
Lead/Lag	Lag
Lead-Lag Optimize?	Yes
Vehicle Extension (s)	2.5
Recall Mode	C-Max
Walk Time (s)	4.0
Flash Dont Walk (s)	14.0
Pedestrian Calls (#/hr)	0
Act Effect Green (s)	117.9
Actuated g/C Ratio	0.74
v/c Ratio	0.02
Control Delay	0.0
Queue Delay	0.0
Total Delay	0.0
LOS	A
Approach Delay	
Approach LOS	
Queue Length 50th (ft)	0
Queue Length 95th (ft)	m0
Internal Link Dist (ft)	
Turn Bay Length (ft)	150
Base Capacity (vph)	1186
Starvation Cap Reductn	0
Spillback Cap Reductn	0
Storage Cap Reductn	0
Reduced v/c Ratio	0.02

Intersection Summary

Area Type: Other  
 Cycle Length: 160  
 Actuated Cycle Length: 160  
 Offset: 89 (56%), Referenced to phase 2:NBSB, Start of Yellow  
 Natural Cycle: 110  
 Control Type: Actuated-Coordinated  
 Maximum v/c Ratio: 0.70  
 Intersection Signal Delay: 10.1 Intersection LOS: B  
 Intersection Capacity Utilization 68.1% ICU Level of Service C  
 Analysis Period (min) 15  
 m Volume for 95th percentile queue is metered by upstream signal.

Splits and Phases: 1368: Preston & Alexis

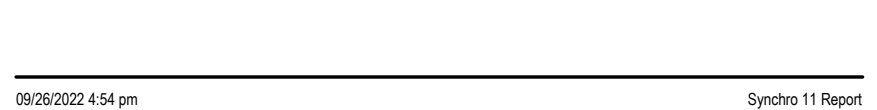

Pepper Square TIA  
Lanes, Volumes, Timings

Phase 1 & P - 2028 Background + Site - AM  
1369: Preston & Belt Line Village Driveway



Lane Group	EBL	EBT	EBR	WBL	WBT	WBR	NBL	NBT	NBR	SBU	SBL	SBT	
Lane Configurations		↕↕		↕	↕		↕	↕↕↕			↕	↕↕↕	
Traffic Volume (vph)	40	1	28	109	2	52	25	1865	41	3	96	2055	
Future Volume (vph)	40	1	28	109	2	52	25	1865	41	3	96	2055	
Ideal Flow (vphpl)	1900	1900	1900	1900	1900	1900	1900	1900	1900	1900	1900	1900	
Storage Length (ft)	0		0	0		0	100		0		100		
Storage Lanes	0		0	1		0	1		0		1		
Taper Length (ft)	25			25			25				25		
Lane Util. Factor	0.95	0.95	0.95	1.00	1.00	1.00	1.00	0.91	0.91	0.91	1.00	0.91	
Fr't		0.939				0.855		0.997				0.998	
Fit Protected		0.972		0.950			0.950				0.950		
Satd. Flow (prot)	0	3230	0	1770	1593	0	1770	5070	0	0	1770	5075	
Fit Permitted		0.785		0.705			0.050				0.045		
Satd. Flow (perm)	0	2609	0	1313	1593	0	93	5070	0	0	84	5075	
Right Turn on Red			Yes		Yes			Yes					
Satd. Flow (RTOR)		31			58			4				2	
Link Speed (mph)		30			30			42				38	
Link Distance (ft)		303			249			252				191	
Travel Time (s)		6.9			5.7			4.1				3.4	
Peak Hour Factor	0.90	0.90	0.90	0.90	0.90	0.90	0.90	0.90	0.90	0.90	0.90	0.90	
Adj. Flow (vph)	44	1	31	121	2	58	28	2072	46	3	107	2283	
Shared Lane Traffic (%)													
Lane Group Flow (vph)	0	76	0	121	60	0	28	2118	0	0	110	2315	
Enter Blocked Intersection	No	No	No	No	No	No	No	No	No	No	No	No	
Lane Alignment	Left	Left	Right	Left	Left	Right	Left	Left	Right	R NA	Left	Left	
Median Width(ft)		12			12			12				12	
Link Offset(ft)		0			0			0				0	
Crosswalk Width(ft)		16			16			16				16	
Two way Left Turn Lane													
Headway Factor	1.00	1.00	1.00	1.00	1.00	1.00	1.00	1.00	1.00	1.00	1.00	1.00	
Turning Speed (mph)	15		9	15		9	15		9	9	15		
Number of Detectors	1	1		1	1		1	1		1	1	1	
Detector Template													
Leading Detector (ft)	50	50		50	50		50	50		50	50	50	
Trailing Detector (ft)	0	0		0	0		0	0		0	0	0	
Detector 1 Position(ft)	0	0		0	0		0	0		0	0	0	
Detector 1 Size(ft)	50	50		50	50		50	50		50	50	50	
Detector 1 Type	CI+Ex	CI+Ex		CI+Ex	CI+Ex		CI+Ex	CI+Ex		CI+Ex	CI+Ex	CI+Ex	
Detector 1 Channel													
Detector 1 Extend (s)	0.0	0.0		0.0	0.0		0.0	0.0		0.0	0.0	0.0	
Detector 1 Queue (s)	0.0	0.0		0.0	0.0		0.0	0.0		0.0	0.0	0.0	
Detector 1 Delay (s)	0.0	0.0		0.0	0.0		0.0	0.0		0.0	0.0	0.0	
Turn Type	Perm	NA		Perm	NA		D.P+P	NA		custom	D.P+P	NA	
Protected Phases		8			4			1	6			5	2
Permitted Phases		8			4			2				5	6
Detector Phase		8			4			1	6			5	2
Switch Phase													
Minimum Initial (s)	20.0	20.0		20.0	20.0		5.0	20.0		5.0	5.0	20.0	
Minimum Split (s)	25.0	25.0		25.0	25.0		10.0	26.0		10.0	10.0	26.0	
Total Split (s)	47.0	47.0		47.0	47.0		20.0	98.0		15.0	15.0	93.0	

Pepper Square TIA  
Lanes, Volumes, Timings

Phase 1 & P - 2028 Background + Site - AM  
1369: Preston & Belt Line Village Driveway



Lane Group	SBR
Lane Configurations	↕
Traffic Volume (vph)	29
Future Volume (vph)	29
Ideal Flow (vphpl)	1900
Storage Length (ft)	0
Storage Lanes	0
Taper Length (ft)	
Lane Util. Factor	0.91
Fr't	
Fit Protected	
Satd. Flow (prot)	0
Fit Permitted	
Satd. Flow (perm)	0
Right Turn on Red	Yes
Satd. Flow (RTOR)	
Link Speed (mph)	
Link Distance (ft)	
Travel Time (s)	
Peak Hour Factor	0.90
Adj. Flow (vph)	32
Shared Lane Traffic (%)	
Lane Group Flow (vph)	0
Enter Blocked Intersection	No
Lane Alignment	Right
Median Width(ft)	
Link Offset(ft)	
Crosswalk Width(ft)	
Two way Left Turn Lane	
Headway Factor	1.00
Turning Speed (mph)	9
Number of Detectors	
Detector Template	
Leading Detector (ft)	
Trailing Detector (ft)	
Detector 1 Position(ft)	
Detector 1 Size(ft)	
Detector 1 Type	
Detector 1 Channel	
Detector 1 Extend (s)	
Detector 1 Queue (s)	
Detector 1 Delay (s)	
Turn Type	
Protected Phases	
Permitted Phases	
Detector Phase	
Switch Phase	
Minimum Initial (s)	
Minimum Split (s)	
Total Split (s)	

Pepper Square TIA  
Lanes, Volumes, Timings

Phase 1 & P - 2028 Background + Site - AM  
1369: Preston & Belt Line Village Driveway



Lane Group	EBL	EBT	EBR	WBL	WBT	WBR	NBL	NBT	NBR	SBU	SBL	SBT
Total Split (%)	29.4%	29.4%		29.4%	29.4%		12.5%	61.3%		9.4%	9.4%	58.1%
Maximum Green (s)	42.3	42.3		42.3	42.3		15.0	93.7		10.0	10.0	88.7
Yellow Time (s)	3.0	3.0		3.0	3.0		3.0	3.0		3.0	3.0	3.0
All-Red Time (s)	1.7	1.7		1.7	1.7		2.0	1.3		2.0	2.0	1.3
Lost Time Adjust (s)		-1.0		-1.0	-1.0		-1.0	-2.0			-1.0	-2.0
Total Lost Time (s)		3.7		3.7	3.7		4.0	2.3			4.0	2.3
Lead/Lag							Lead	Lead		Lag	Lag	Lag
Lead-Lag Optimize?							Yes	Yes		Yes	Yes	Yes
Vehicle Extension (s)	2.0	2.0		2.0	2.0		1.5	3.0		1.5	1.5	3.3
Recall Mode	None	None		None	None		None	None		None	None	C-Max
Walk Time (s)	5.0	5.0		5.0	5.0			7.0				7.0
Flash Dont Walk (s)	15.0	15.0		15.0	15.0			8.0				8.0
Pedestrian Calls (#/hr)	0	0		0	0			0				0
Act Effect Green (s)		23.0		23.0	23.0		126.9	92.1			125.3	124.9
Actuated g/C Ratio		0.14		0.14	0.14		0.79	0.58			0.78	0.78
v/c Ratio		0.19		0.64	0.22		0.20	0.73			0.25	0.58
Control Delay		37.0		80.3	15.4		6.1	10.9			17.3	2.3
Queue Delay		0.0		0.0	0.0		0.0	1.0			0.0	0.1
Total Delay		37.0		80.3	15.4		6.1	11.9			17.3	2.4
LOS		D		F	B		A	B			B	A
Approach Delay		37.0			58.8			11.9				3.0
Approach LOS		D			E			B				A
Queue Length 50th (ft)		22		123	2		2	147			55	65
Queue Length 95th (ft)		47		189	45		m4	221			m82	89
Internal Link Dist (ft)		223			169			172				111
Turn Bay Length (ft)							100				100	
Base Capacity (vph)		728		355	473		243	3034			433	3963
Starvation Cap Reductn		0		0	0		0	78			0	331
Spillback Cap Reductn		1		0	6		0	600			0	0
Storage Cap Reductn		0		0	0		0	0			0	0
Reduced v/c Ratio		0.10		0.34	0.13		0.12	0.87			0.25	0.64

Intersection Summary

Area Type: Other  
 Cycle Length: 160  
 Actuated Cycle Length: 160  
 Offset: 86 (54%), Referenced to phase 2:NBSB, Start of Yellow  
 Natural Cycle: 70  
 Control Type: Actuated-Coordinated  
 Maximum v/c Ratio: 0.73  
 Intersection Signal Delay: 9.6 Intersection LOS: A  
 Intersection Capacity Utilization 71.2% ICU Level of Service C  
 Analysis Period (min) 15  
 m Volume for 95th percentile queue is metered by upstream signal.

Splits and Phases: 1369: Preston & Belt Line Village Driveway

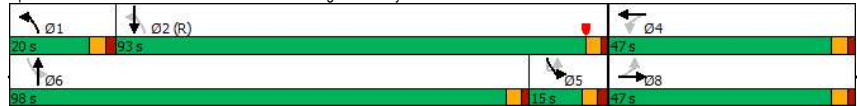

Pepper Square TIA  
Lanes, Volumes, Timings

Phase 1 & P - 2028 Background + Site - AM  
1369: Preston & Belt Line Village Driveway



Lane Group	SBR
Total Split (%)	
Maximum Green (s)	
Yellow Time (s)	
All-Red Time (s)	
Lost Time Adjust (s)	
Total Lost Time (s)	
Lead/Lag	
Lead-Lag Optimize?	
Vehicle Extension (s)	
Recall Mode	
Walk Time (s)	
Flash Dont Walk (s)	
Pedestrian Calls (#/hr)	
Act Effect Green (s)	
Actuated g/C Ratio	
v/c Ratio	
Control Delay	
Queue Delay	
Total Delay	
LOS	
Approach Delay	
Approach LOS	
Queue Length 50th (ft)	
Queue Length 95th (ft)	
Internal Link Dist (ft)	
Turn Bay Length (ft)	
Base Capacity (vph)	
Starvation Cap Reductn	
Spillback Cap Reductn	
Storage Cap Reductn	
Reduced v/c Ratio	

Intersection Summary

Area Type: Other  
 Cycle Length: 160  
 Actuated Cycle Length: 160  
 Offset: 86 (54%), Referenced to phase 2:NBSB, Start of Yellow  
 Natural Cycle: 70  
 Control Type: Actuated-Coordinated  
 Maximum v/c Ratio: 0.73  
 Intersection Signal Delay: 9.6 Intersection LOS: A  
 Intersection Capacity Utilization 71.2% ICU Level of Service C  
 Analysis Period (min) 15  
 m Volume for 95th percentile queue is metered by upstream signal.

Pepper Square TIA  
Lanes, Volumes, Timings

Phase 1 & P - 2028 Background + Site - AM  
1371: Preston & Spring Valley

Lane Group	EBL	EBT	EBR	WBL	WBT	WBR	NBL	NBT	NBR	SBU	SBL	SBT
Lane Configurations	↑↑	↑↑↑		↑↑	↑↑↑		↑↑	↑↑↑			↑↑	↑↑↑
Traffic Volume (vph)	172	366	253	90	736	160	115	1617	76	1	165	2077
Future Volume (vph)	172	366	253	90	736	160	115	1617	76	1	165	2077
Ideal Flow (vphpl)	1900	1900	1900	1900	1900	1900	1900	1900	1900	1900	1900	1900
Storage Length (ft)	225		0	225		0	225		0		275	
Storage Lanes	2		0	2		0	2		0		2	
Taper Length (ft)	25			25			25				25	
Lane Util. Factor	0.97	0.91	0.91	0.97	0.91	0.91	0.97	0.91	0.91	0.91	0.97	0.91
Frt		0.939			0.973			0.993				0.985
Fit Protected	0.950			0.950			0.950				0.950	
Satd. Flow (prot)	3433	4775	0	3433	4948	0	3433	5050	0	0	3433	5009
Fit Permitted	0.950			0.950			0.950				0.950	
Satd. Flow (perm)	3433	4775	0	3433	4948	0	3433	5050	0	0	3433	5009
Right Turn on Red			Yes			Yes			Yes			
Satd. Flow (RTOR)		103			29			5				17
Link Speed (mph)		38			42			41				38
Link Distance (ft)		3259			5488			2139				1208
Travel Time (s)		58.5			89.1			35.6				21.7
Peak Hour Factor	0.96	0.96	0.96	0.96	0.96	0.96	0.96	0.96	0.96	0.96	0.96	0.96
Adj. Flow (vph)	179	381	264	94	767	167	120	1684	79	1	172	2164
Shared Lane Traffic (%)												
Lane Group Flow (vph)	179	645	0	94	934	0	120	1763	0	0	173	2396
Enter Blocked Intersection	No	No	No	No	No	No	No	No	No	No	No	No
Lane Alignment	Left	Left	Right	Left	Left	Right	Left	Left	Right	R NA	Left	Left
Median Width(ft)		24			24			24				24
Link Offset(ft)		0			0			0				0
Crosswalk Width(ft)		16			16			16				16
Two way Left Turn Lane												
Headway Factor	1.00	1.00	1.00	1.00	1.00	1.00	1.00	1.00	1.00	1.00	1.00	1.00
Turning Speed (mph)	15		9	15		9	15		9	9	15	
Number of Detectors	1	1		1	1		1	1		1	1	1
Detector Template												
Leading Detector (ft)	50	50		50	50		50	50		50	50	50
Trailing Detector (ft)	0	0		0	0		0	0		0	0	0
Detector 1 Position(ft)	0	0		0	0		0	0		0	0	0
Detector 1 Size(ft)	50	50		50	50		50	50		50	50	50
Detector 1 Type	Cl+Ex	Cl+Ex		Cl+Ex	Cl+Ex		Cl+Ex	Cl+Ex		Cl+Ex	Cl+Ex	Cl+Ex
Detector 1 Channel												
Detector 1 Extend (s)	0.0	0.0		0.0	0.0		0.0	0.0		0.0	0.0	0.0
Detector 1 Queue (s)	0.0	0.0		0.0	0.0		0.0	0.0		0.0	0.0	0.0
Detector 1 Delay (s)	0.0	0.0		0.0	0.0		0.0	0.0		0.0	0.0	0.0
Turn Type	Prot	NA		Prot	NA		Prot	NA		Prot	Prot	NA
Protected Phases	3	8		7	4		1	6		5	5	2
Permitted Phases												
Detector Phase	3	8		7	4		1	6		5	5	2
Switch Phase												
Minimum Initial (s)	6.0	12.0		3.0	12.0		3.0	13.0		3.0	3.0	18.0
Minimum Split (s)	11.0	27.5		11.0	27.5		11.0	28.0		11.0	11.0	28.0
Total Split (s)	15.0	43.0		16.0	44.0		13.0	71.0		30.0	30.0	88.0

Pepper Square TIA  
Lanes, Volumes, Timings

Phase 1 & P - 2028 Background + Site - AM  
1371: Preston & Spring Valley

Lane Group	SBR
Lane Configurations	↑↑↑
Traffic Volume (vph)	223
Future Volume (vph)	223
Ideal Flow (vphpl)	1900
Storage Length (ft)	0
Storage Lanes	0
Taper Length (ft)	
Lane Util. Factor	0.91
Frt	
Fit Protected	
Satd. Flow (prot)	0
Fit Permitted	
Satd. Flow (perm)	0
Right Turn on Red	Yes
Satd. Flow (RTOR)	
Link Speed (mph)	
Link Distance (ft)	
Travel Time (s)	
Peak Hour Factor	0.96
Adj. Flow (vph)	232
Shared Lane Traffic (%)	
Lane Group Flow (vph)	0
Enter Blocked Intersection	No
Lane Alignment	Right
Median Width(ft)	
Link Offset(ft)	
Crosswalk Width(ft)	
Two way Left Turn Lane	
Headway Factor	1.00
Turning Speed (mph)	9
Number of Detectors	
Detector Template	
Leading Detector (ft)	
Trailing Detector (ft)	
Detector 1 Position(ft)	
Detector 1 Size(ft)	
Detector 1 Type	
Detector 1 Channel	
Detector 1 Extend (s)	
Detector 1 Queue (s)	
Detector 1 Delay (s)	
Turn Type	
Protected Phases	
Permitted Phases	
Detector Phase	
Switch Phase	
Minimum Initial (s)	
Minimum Split (s)	
Total Split (s)	



Pepper Square TIA  
Lanes, Volumes, Timings

Phase 1 & P - 2028 Background + Site - AM  
1371: Preston & Spring Valley



Lane Group	EBL	EBT	EBR	WBL	WBT	WBR	NBL	NBT	NBR	SBU	SBL	SBT
Total Split (%)	9.4%	26.9%		10.0%	27.5%		8.1%	44.4%		18.8%	18.8%	55.0%
Maximum Green (s)	10.0	37.5		11.0	38.5		8.0	65.0		25.0	25.0	82.0
Yellow Time (s)	3.0	4.0		3.0	4.0		3.0	4.5		3.0	3.0	4.5
All-Red Time (s)	2.0	1.5		2.0	1.5		2.0	1.5		2.0	2.0	1.5
Lost Time Adjust (s)	-1.0	-1.5		-1.0	-1.5		-1.0	-2.0		-1.0	-2.0	
Total Lost Time (s)	4.0	4.0		4.0	4.0		4.0	4.0		4.0	4.0	
Lead/Lag	Lead	Lead		Lag	Lag		Lead	Lead		Lag	Lag	
Lead-Lag Optimize?	Yes	Yes		Yes	Yes		Yes	Yes		Yes	Yes	Yes
Vehicle Extension (s)	0.8	2.0		0.8	2.0		0.8	2.5		0.8	0.8	2.4
Recall Mode	None	None		None	None		None	None		None	None	C-Max
Walk Time (s)		4.0			4.0			4.0				4.0
Flash Dont Walk (s)		18.0			18.0			18.0				18.0
Pedestrian Calls (#/hr)		0			0			0				0
Act Effect Green (s)	10.6	24.5		21.5	35.4		8.9	66.5			31.5	89.1
Actuated g/C Ratio	0.07	0.15		0.13	0.22		0.06	0.42			0.20	0.56
v/c Ratio	0.79	0.79		0.20	0.84		0.63	0.84			0.26	0.86
Control Delay	88.2	59.1		63.0	59.7		91.8	46.1			70.1	45.5
Queue Delay	0.0	0.0		0.0	0.0		0.0	0.0			0.0	0.0
Total Delay	88.2	59.1		63.0	59.7		91.8	46.1			70.1	45.5
LOS	F	E		E	E		F	D			E	D
Approach Delay		65.4			60.0			49.0				47.1
Approach LOS		E			E			D				D
Queue Length 50th (ft)	96	217		48	352		67	467			90	910
Queue Length 95th (ft)	#152	254		m47	m328		m103	504			m128	1008
Internal Link Dist (ft)		3179			5408			2059				1128
Turn Bay Length (ft)	225			225			225				275	
Base Capacity (vph)	236	1241		460	1258		203	2127			675	2796
Starvation Cap Reductn	0	0		0	0		0	0			0	0
Spillback Cap Reductn	0	0		0	0		0	0			0	0
Storage Cap Reductn	0	0		0	0		0	0			0	0
Reduced v/c Ratio	0.76	0.52		0.20	0.74		0.59	0.83			0.26	0.86

Intersection Summary

Area Type: Other  
 Cycle Length: 160  
 Actuated Cycle Length: 160  
 Offset: 156 (98%), Referenced to phase 2:SBT, Start of Yellow  
 Natural Cycle: 100  
 Control Type: Actuated-Coordinated  
 Maximum v/c Ratio: 0.86  
 Intersection Signal Delay: 52.2 Intersection LOS: D  
 Intersection Capacity Utilization 84.6% ICU Level of Service E  
 Analysis Period (min) 15  
 # 95th percentile volume exceeds capacity, queue may be longer.  
 Queue shown is maximum after two cycles.  
 m Volume for 95th percentile queue is metered by upstream signal.

Splits and Phases: 1371: Preston & Spring Valley

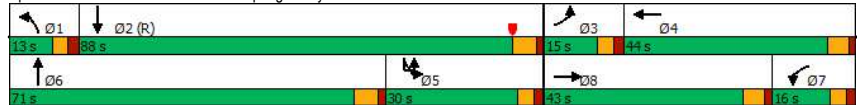

Pepper Square TIA  
Lanes, Volumes, Timings

Phase 1 & P - 2028 Background + Site - AM  
1371: Preston & Spring Valley



Lane Group	SBR
Total Split (%)	55.0%
Maximum Green (s)	82.0
Yellow Time (s)	4.5
All-Red Time (s)	1.5
Lost Time Adjust (s)	-2.0
Total Lost Time (s)	4.0
Lead/Lag	Lag
Lead-Lag Optimize?	Yes
Vehicle Extension (s)	2.4
Recall Mode	C-Max
Walk Time (s)	4.0
Flash Dont Walk (s)	18.0
Pedestrian Calls (#/hr)	0
Act Effect Green (s)	89.1
Actuated g/C Ratio	0.56
v/c Ratio	0.86
Control Delay	45.5
Queue Delay	0.0
Total Delay	45.5
LOS	D
Approach Delay	47.1
Approach LOS	D
Queue Length 50th (ft)	910
Queue Length 95th (ft)	1008
Internal Link Dist (ft)	1128
Turn Bay Length (ft)	
Base Capacity (vph)	2796
Starvation Cap Reductn	0
Spillback Cap Reductn	0
Storage Cap Reductn	0
Reduced v/c Ratio	0.86

Intersection Summary

Area Type: Other  
 Cycle Length: 160  
 Actuated Cycle Length: 160  
 Offset: 156 (98%), Referenced to phase 2:SBT, Start of Yellow  
 Natural Cycle: 100  
 Control Type: Actuated-Coordinated  
 Maximum v/c Ratio: 0.86  
 Intersection Signal Delay: 52.2 Intersection LOS: D  
 Intersection Capacity Utilization 84.6% ICU Level of Service E  
 Analysis Period (min) 15  
 # 95th percentile volume exceeds capacity, queue may be longer.  
 Queue shown is maximum after two cycles.  
 m Volume for 95th percentile queue is metered by upstream signal.

Pepper Square TIA  
Lanes, Volumes, Timings

Phase 1 & P - 2028 Background + Site - AM  
1405: Prestonwood & Belt Line

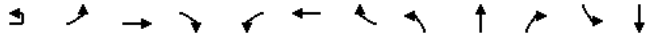

Lane Group	EBU	EBL	EBT	EBR	WBL	WBT	WBR	NBL	NBT	NBR	SBL	SBT
Lane Configurations			↑↑↑		↑↑↑				↑		↑↑	↑
Traffic Volume (vph)	4	41	799	3	4	1526	49	1	0	5	39	1
Future Volume (vph)	4	41	799	3	4	1526	49	1	0	5	39	1
Ideal Flow (vphpl)	1900	1900	1900	1900	1900	1900	1900	1900	1900	1900	1900	1900
Storage Length (ft)		200		0	200		0	0		0	300	
Storage Lanes		1		0	1		0	0		0	2	
Taper Length (ft)		25			25			25			25	
Lane Util. Factor	0.91	1.00	0.91	0.91	1.00	0.91	0.91	1.00	1.00	1.00	0.97	0.95
Frt			0.999			0.995			0.887			0.854
Fit Protected		0.950			0.950				0.992		0.950	
Satd. Flow (prot)	0	1770	5080	0	1770	5060	0	0	1639	0	3433	1511
Fit Permitted		0.120			0.319				0.992		0.950	
Satd. Flow (perm)	0	224	5080	0	594	5060	0	0	1639	0	3433	1511
Right Turn on Red			Yes			Yes			Yes			
Satd. Flow (RTOR)			1			6			131			33
Link Speed (mph)			42			42			30			30
Link Distance (ft)			1445			2036			315			868
Travel Time (s)			23.5			33.1			7.2			19.7
Peak Hour Factor	0.95	0.95	0.95	0.95	0.95	0.95	0.95	0.95	0.95	0.95	0.95	0.95
Adj. Flow (vph)	4	43	841	3	4	1606	52	1	0	5	41	1
Shared Lane Traffic (%)												
Lane Group Flow (vph)	0	47	844	0	4	1658	0	0	6	0	41	34
Enter Blocked Intersection	No	No	No	No	No	No	No	No	No	No	No	No
Lane Alignment	R NA	Left	Left	Right	Left	Left	Right	Left	Left	Right	Left	Left
Median Width(ft)			24			24			24			24
Link Offset(ft)			0			0			0			0
Crosswalk Width(ft)			16			16			16			16
Two way Left Turn Lane												
Headway Factor	1.00	1.00	1.00	1.00	1.00	1.00	1.00	1.00	1.00	1.00	1.00	1.00
Turning Speed (mph)	9	15		9	15		9	15		9	15	
Number of Detectors	1	1	1		1	1		1	1		1	1
Detector Template												
Leading Detector (ft)	50	50	50		50	50		50	50		50	50
Trailing Detector (ft)	0	0	0		0	0		0	0		0	0
Detector 1 Position(ft)	0	0	0		0	0		0	0		0	0
Detector 1 Size(ft)	50	50	50		50	50		50	50		50	50
Detector 1 Type	Cl+Ex	Cl+Ex	Cl+Ex		Cl+Ex	Cl+Ex		Cl+Ex	Cl+Ex		Cl+Ex	Cl+Ex
Detector 1 Channel												
Detector 1 Extend (s)	0.0	0.0	0.0		0.0	0.0		0.0	0.0		0.0	0.0
Detector 1 Queue (s)	0.0	0.0	0.0		0.0	0.0		0.0	0.0		0.0	0.0
Detector 1 Delay (s)	0.0	0.0	0.0		0.0	0.0		0.0	0.0		0.0	0.0
Turn Type	custom	D,P+P	NA		D,P+P	NA		Split	NA		Split	NA
Protected Phases		1	6		5	2		3	3		4	4
Permitted Phases		1	2		6							
Detector Phase	1	1	6		5	2		3	3		4	4
Switch Phase												
Minimum Initial (s)	3.0	3.0	15.0		3.0	15.0		5.0	5.0		7.0	7.0
Minimum Split (s)	8.0	8.0	22.0		8.0	24.0		23.0	23.0		23.2	23.2
Total Split (s)	15.0	15.0	109.0		15.0	109.0		18.0	18.0		18.0	18.0

Pepper Square TIA  
Lanes, Volumes, Timings

Phase 1 & P - 2028 Background + Site - AM  
1405: Prestonwood & Belt Line



Lane Group	SBR
Lane Configurations	↑
Traffic Volume (vph)	64
Future Volume (vph)	64
Ideal Flow (vphpl)	1900
Storage Length (ft)	0
Storage Lanes	1
Taper Length (ft)	
Lane Util. Factor	0.95
Frt	0.850
Fit Protected	
Satd. Flow (prot)	1504
Fit Permitted	
Satd. Flow (perm)	1504
Right Turn on Red	Yes
Satd. Flow (RTOR)	89
Link Speed (mph)	
Link Distance (ft)	
Travel Time (s)	
Peak Hour Factor	0.95
Adj. Flow (vph)	67
Shared Lane Traffic (%)	49%
Lane Group Flow (vph)	34
Enter Blocked Intersection	No
Lane Alignment	Right
Median Width(ft)	
Link Offset(ft)	
Crosswalk Width(ft)	
Two way Left Turn Lane	
Headway Factor	1.00
Turning Speed (mph)	9
Number of Detectors	1
Detector Template	
Leading Detector (ft)	50
Trailing Detector (ft)	0
Detector 1 Position(ft)	0
Detector 1 Size(ft)	50
Detector 1 Type	Cl+Ex
Detector 1 Channel	
Detector 1 Extend (s)	0.0
Detector 1 Queue (s)	0.0
Detector 1 Delay (s)	0.0
Turn Type	custom
Protected Phases	
Permitted Phases	1 4
Detector Phase	1 4
Switch Phase	
Minimum Initial (s)	
Minimum Split (s)	
Total Split (s)	

Pepper Square TIA  
Lanes, Volumes, Timings

Phase 1 & P - 2028 Background + Site - AM  
1405: Prestonwood & Belt Line

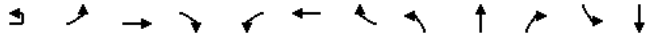

Lane Group	EBU	EBL	EBT	EBR	WBL	WBT	WBR	NBL	NBT	NBR	SBL	SBT
Total Split (%)	9.4%	9.4%	68.1%	9.4%	9.4%	68.1%	11.3%	11.3%	11.3%	11.3%	11.3%	11.3%
Maximum Green (s)	10.0	10.0	103.0	10.0	10.0	103.0	13.0	13.0	12.8	12.8		
Yellow Time (s)	3.0	3.0	4.5	3.0	3.0	4.5	3.0	3.0	3.2	3.2		
All-Red Time (s)	2.0	2.0	1.5	2.0	2.0	1.5	2.0	2.0	2.0	2.0		
Lost Time Adjust (s)		-1.0	-2.0	-1.0	-2.0		-1.0	-2.0	-1.2	-1.2		
Total Lost Time (s)		4.0	4.0	4.0	4.0		4.0	4.0	4.0	4.0		
Lead/Lag	Lag	Lag	Lag	Lead	Lead		Lead	Lead	Lag	Lag		
Lead-Lag Optimize?	Yes	Yes	Yes	Yes	Yes		Yes	Yes	Yes	Yes		
Vehicle Extension (s)	1.0	1.0	2.5	1.0	2.5		1.5	1.5	1.5	1.5		
Recall Mode	None	None	C-Max	None	Max		None	None	None	None		
Walk Time (s)			5.0		4.0		4.0	4.0	4.0	4.0		
Flash Dont Walk (s)			10.0		14.0		14.0	14.0	14.0	14.0		
Pedestrian Calls (#/hr)			0		0		0	0	0	0		
Act Effect Green (s)		141.7	143.1		143.3	132.9		6.0	8.4	8.4		
Actuated g/C Ratio		0.89	0.89		0.90	0.83		0.04	0.05	0.05		
v/c Ratio		0.16	0.19		0.01	0.39		0.03	0.23	0.31		
Control Delay		4.7	1.5		0.8	1.7		0.3	75.9	29.8		
Queue Delay		0.0	0.0		0.0	0.0		0.0	0.0	0.0		
Total Delay		4.7	1.5		0.8	1.7		0.3	75.9	29.8		
LOS		A	A		A	A		A	E	C		
Approach Delay			1.7		1.7			0.3		38.2		
Approach LOS			A		A			A		D		
Queue Length 50th (ft)		3	23		0	54		0	21	1		
Queue Length 95th (ft)		14	64		m1	m75		0	43	41		
Internal Link Dist (ft)			1365			1956		235		788		
Turn Bay Length (ft)		200			200				300			
Base Capacity (vph)		303	4544		615	4203		262	300	162		
Starvation Cap Reductn		0	0		0	0		0	0	0		
Spillback Cap Reductn		0	0		0	0		0	0	0		
Storage Cap Reductn		0	0		0	0		0	0	0		
Reduced v/c Ratio		0.16	0.19		0.01	0.39		0.02	0.14	0.21		

Intersection Summary

Area Type: Other  
 Cycle Length: 160  
 Actuated Cycle Length: 160  
 Offset: 73 (46%), Referenced to phase 6:EBWB, Start of Yellow  
 Natural Cycle: 90  
 Control Type: Actuated-Coordinated  
 Maximum v/c Ratio: 0.39  
 Intersection Signal Delay: 3.2 Intersection LOS: A  
 Intersection Capacity Utilization 54.7% ICU Level of Service A  
 Analysis Period (min) 15  
 m Volume for 95th percentile queue is metered by upstream signal.

Splits and Phases: 1405: Prestonwood & Belt Line



Pepper Square TIA  
Lanes, Volumes, Timings

Phase 1 & P - 2028 Background + Site - AM  
1405: Prestonwood & Belt Line



Lane Group	SBR
Total Split (%)	11.3%
Maximum Green (s)	12.8
Yellow Time (s)	3.2
All-Red Time (s)	2.0
Lost Time Adjust (s)	-1.2
Total Lost Time (s)	4.0
Lead/Lag	Lag
Lead-Lag Optimize?	Yes
Vehicle Extension (s)	1.5
Recall Mode	None
Walk Time (s)	4.0
Flash Dont Walk (s)	14.0
Pedestrian Calls (#/hr)	0
Act Effect Green (s)	20.5
Actuated g/C Ratio	0.13
v/c Ratio	0.13
Control Delay	1.0
Queue Delay	0.0
Total Delay	1.0
LOS	A
Approach Delay	
Approach LOS	
Queue Length 50th (ft)	0
Queue Length 95th (ft)	0
Internal Link Dist (ft)	
Turn Bay Length (ft)	
Base Capacity (vph)	338
Starvation Cap Reductn	0
Spillback Cap Reductn	0
Storage Cap Reductn	0
Reduced v/c Ratio	0.10

Intersection Summary

Area Type: Other  
 Cycle Length: 160  
 Actuated Cycle Length: 160  
 Offset: 73 (46%), Referenced to phase 6:EBWB, Start of Yellow  
 Natural Cycle: 90  
 Control Type: Actuated-Coordinated  
 Maximum v/c Ratio: 0.39  
 Intersection Signal Delay: 3.2 Intersection LOS: A  
 Intersection Capacity Utilization 54.7% ICU Level of Service A  
 Analysis Period (min) 15  
 m Volume for 95th percentile queue is metered by upstream signal.

Splits and Phases: 1405: Prestonwood & Belt Line

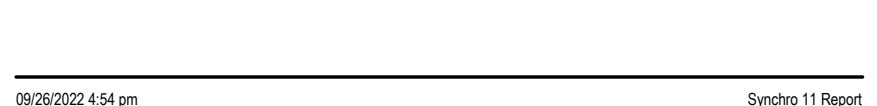

Pepper Square TIA  
HCM 6th TWSC

Phase 1 & P - 2028 Background + Site - AM  
2: Ladera Drive & Belt Line

Intersection													
Int Delay, s/veh	6.9												
Movement	EBL	EBT	EBR	WBL	WBT	WBR	NBL	NBT	NBR	SBL	SBT	SBR	
Lane Configurations	↔ ↗ ↘			↔ ↗ ↘					↕	↕	↕	↕	
Traffic Vol, veh/h	50	781	16	23	1410	22	41	0	65	43	0	109	
Future Vol, veh/h	50	781	16	23	1410	22	41	0	65	43	0	109	
Conflicting Peds, #/hr	0	0	0	0	0	0	0	0	0	0	0	0	
Sign Control	Free	Free	Free	Free	Free	Free	Stop	Stop	Stop	Stop	Stop	Stop	
RT Channelized	-	-	None	-	-	None	-	-	None	-	-	None	
Storage Length	100	-	-	100	-	-	-	-	0	-	-	0	
Veh in Median Storage, #	-	0	-	-	0	-	-	1	-	-	1	-	
Grade, %	-	0	-	-	0	-	-	0	-	-	0	-	
Peak Hour Factor	91	91	91	91	91	91	91	91	91	91	91	91	
Heavy Vehicles, %	2	2	2	2	2	2	2	2	2	2	2	2	
Mvmt Flow	55	858	18	25	1549	24	45	0	71	47	0	120	

Major/Minor	Major1	Major2	Minor1	Minor2
Conflicting Flow All	1573	0	0	876
Stage 1	-	-	-	-
Stage 2	-	-	-	-
Critical Hdwy	5.34	-	-	5.34
Critical Hdwy Stg 1	-	-	-	-
Critical Hdwy Stg 2	-	-	-	-
Follow-up Hdwy	3.12	-	-	3.12
Pot Cap-1 Maneuver	205	-	-	871
Stage 1	-	-	-	-
Stage 2	-	-	-	-
Platoon blocked, %	-	-	1	-
Mov Cap-1 Maneuver	205	-	-	871
Mov Cap-2 Maneuver	-	-	-	-
Stage 1	-	-	-	-
Stage 2	-	-	-	-

Approach	EB	WB	NB	SB
HCM Control Delay, s	1.7	0.1	23.7	89.3
HCM LOS			C	F

Minor Lane/Major Mvmt	NBLn1	NBLn2	EBL	EBT	EBR	WBL	WBT	WBR	SBLn1	SBLn2
Capacity (veh/h)	134	752	205	-	-	871	-	-	49	287
HCM Lane V/C Ratio	0.336	0.095	0.268	-	-	0.029	-	-	0.964	0.417
HCM Control Delay (s)	44.9	10.3	28.9	-	-	9.3	-	-	249.2	26.2
HCM Lane LOS	E	B	D	-	-	A	-	-	F	D
HCM 95th %tile Q(veh)	1.4	0.3	1	-	-	0.1	-	-	4.1	2

Notes  
 ~: Volume exceeds capacity    \$: Delay exceeds 300s    +: Computation Not Defined    \*: All major volume in platoon

Pepper Square TIA  
HCM 6th TWSC

Phase 1 & P - 2028 Background + Site - AM  
3: Median Opening East of Preston Rd & Belt Line

Intersection													
Int Delay, s/veh	0.3												
Movement	EBU	EBL	EBT	EBR	WBL	WBT	WBR	NBL	NBT	NBR	SBL	SBT	SBR
Lane Configurations	↔ ↗ ↘			↔ ↗ ↘							↕	↕	
Traffic Vol, veh/h	4	21	577	4	13	1140	18	1	2	0	1	0	3
Future Vol, veh/h	4	21	577	4	13	1140	18	1	2	0	1	0	3
Conflicting Peds, #/hr	0	0	0	0	0	0	0	0	0	0	0	0	0
Sign Control	Free	Free	Free	Free	Free	Free	Free	Stop	Stop	Stop	Stop	Stop	Stop
RT Channelized	-	-	-	None	-	-	None	-	-	None	-	-	None
Storage Length	-	150	-	-	200	-	-	-	-	-	-	-	-
Veh in Median Storage, #	-	-	0	-	0	-	-	-	1	-	-	1	-
Grade, %	-	-	0	-	-	0	-	-	0	-	-	0	-
Peak Hour Factor	96	96	96	96	96	96	96	96	96	96	96	96	96
Heavy Vehicles, %	2	2	2	2	2	2	2	2	2	2	2	2	2
Mvmt Flow	4	22	601	4	14	1188	19	1	2	0	1	0	3

Major/Minor	Major1	Major2	Minor1	Minor2
Conflicting Flow All	881	1207	0	0
Stage 1	-	-	-	-
Stage 2	-	-	-	-
Critical Hdwy	5.64	5.34	-	-
Critical Hdwy Stg 1	-	-	-	-
Critical Hdwy Stg 2	-	-	-	-
Follow-up Hdwy	2.32	3.12	-	-
Pot Cap-1 Maneuver	*1106	*823	-	-
Stage 1	-	-	-	-
Stage 2	-	-	-	-
Platoon blocked, %	1	1	-	-
Mov Cap-1 Maneuver	*858	*858	-	-
Mov Cap-2 Maneuver	-	-	-	-
Stage 1	-	-	-	-
Stage 2	-	-	-	-

Approach	EB	WB	NB	SB
HCM Control Delay, s	0.4	0.1	14.6	11
HCM LOS			B	B

Minor Lane/Major Mvmt	NBLn1	EBL	EBT	EBR	WBL	WBT	WBR	SBLn1
Capacity (veh/h)	378	*858	-	-	604	-	-	600
HCM Lane V/C Ratio	0.008	0.03	-	-	0.022	-	-	0.007
HCM Control Delay (s)	14.6	9.3	-	-	11.1	-	-	11
HCM Lane LOS	B	A	-	-	B	-	-	B
HCM 95th %tile Q(veh)	0	0.1	-	-	0.1	-	-	0

Notes  
 ~: Volume exceeds capacity    \$: Delay exceeds 300s    +: Computation Not Defined    \*: All major volume in platoon

Pepper Square TIA  
HCM 6th TWSC

Phase 1 & P - 2028 Background + Site - AM  
5: Belt Line & Median between Berry Trail and Alexis Dr

Intersection												
Int Delay, s/veh	0.8											
Movement	EBL	EBT	EBR	WBL	WBT	WBR	NBL	NBT	NBR	SBL	SBT	SBR
Lane Configurations	↔ ↗ ↘			↔ ↗ ↘			↔			↔		
Traffic Vol, veh/h	5	607	38	36	1099	11	18	0	70	6	1	7
Future Vol, veh/h	5	607	38	36	1099	11	18	0	70	6	1	7
Conflicting Peds, #/hr	0	0	0	0	0	0	0	0	0	0	0	0
Sign Control	Free	Free	Free	Free	Free	Stop	Stop	Stop	Stop	Stop	Stop	Stop
RT Channelized	-	-	None	-	-	None	-	-	None	-	-	None
Storage Length	150	-	-	150	-	-	-	-	-	-	-	-
Veh in Median Storage, #	-	0	-	-	0	-	-	1	-	-	1	-
Grade, %	-	0	-	-	0	-	-	0	-	-	0	-
Peak Hour Factor	88	88	88	88	88	88	88	88	88	88	88	88
Heavy Vehicles, %	2	2	2	2	2	2	2	2	2	2	2	2
Mvmt Flow	6	690	43	41	1249	13	20	0	80	7	1	8

Major/Minor	Major1	Major2	Minor1	Minor2
Conflicting Flow All	1262	0	0	733
Stage 1	-	-	-	-
Stage 2	-	-	-	-
Critical Hdwy	5.34	-	-	5.34
Critical Hdwy Stg 1	-	-	-	-
Critical Hdwy Stg 2	-	-	-	-
Follow-up Hdwy	3.12	-	-	3.12
Pot Cap-1 Maneuver	781	-	-	894
Stage 1	-	-	-	-
Stage 2	-	-	-	-
Platoon blocked, %	1	-	-	1
Mov Cap-1 Maneuver	781	-	-	894
Mov Cap-2 Maneuver	-	-	-	-
Stage 1	-	-	-	-
Stage 2	-	-	-	-

Approach	EB	WB	NB	SB
HCM Control Delay, s	0.1	0.3	10.8	11.8
HCM LOS			B	B

Minor Lane/Major Mvmt	NBLn1	EBL	EBT	EBR	WBL	WBT	WBR	SBLn1
Capacity (veh/h)	722	781	-	-	894	-	-	544
HCM Lane V/C Ratio	0.139	0.007	-	-	0.046	-	-	0.029
HCM Control Delay (s)	10.8	9.6	-	-	9.2	-	-	11.8
HCM Lane LOS	B	A	-	-	A	-	-	B
HCM 95th %tile Q(veh)	0.5	0	-	-	0.1	-	-	0.1

Notes  
 ~: Volume exceeds capacity    \$: Delay exceeds 300s    +: Computation Not Defined    \*: All major volume in platoon

Pepper Square TIA  
HCM 6th TWSC

Phase 1 & P - 2028 Background + Site - AM  
6: Alexis Drive & Belt Line

Intersection						
Int Delay, s/veh	1.7					
Movement	EBT	EBR	WBL	WBT	NBL	NBR
Lane Configurations	↔ ↗		↔ ↗ ↘		↔ ↗	
Traffic Vol, veh/h	667	5	160	1120	12	174
Future Vol, veh/h	667	5	160	1120	12	174
Conflicting Peds, #/hr	0	0	0	0	0	0
Sign Control	Free	Free	Free	Free	Stop	Stop
RT Channelized	-	None	-	None	-	Yield
Storage Length	-	-	150	-	0	0
Veh in Median Storage, #	0	-	-	0	1	-
Grade, %	0	-	-	0	0	-
Peak Hour Factor	86	86	86	86	86	86
Heavy Vehicles, %	2	2	2	2	2	2
Mvmt Flow	776	6	186	1302	14	202

Major/Minor	Major1	Major2	Minor1
Conflicting Flow All	0	0	782
Stage 1	-	-	-
Stage 2	-	-	-
Critical Hdwy	-	-	5.34
Critical Hdwy Stg 1	-	-	-
Critical Hdwy Stg 2	-	-	-
Follow-up Hdwy	-	-	3.12
Pot Cap-1 Maneuver	-	-	907
Stage 1	-	-	-
Stage 2	-	-	-
Platoon blocked, %	-	-	1
Mov Cap-1 Maneuver	-	-	907
Mov Cap-2 Maneuver	-	-	-
Stage 1	-	-	-
Stage 2	-	-	-

Approach	EB	WB	NB
HCM Control Delay, s	0	1.2	11.5
HCM LOS			B

Minor Lane/Major Mvmt	NBLn1	NBLn2	EBT	EBR	WBL	WBT
Capacity (veh/h)	468	768	-	-	907	-
HCM Lane V/C Ratio	0.03	0.263	-	-	0.205	-
HCM Control Delay (s)	12.9	11.4	-	-	10	-
HCM Lane LOS	B	B	-	-	A	-
HCM 95th %tile Q(veh)	0.1	1.1	-	-	0.8	-

Notes  
 ~: Volume exceeds capacity    \$: Delay exceeds 300s    +: Computation Not Defined    \*: All major volume in platoon

Pepper Square TIA  
HCM 6th TWSC

Phase 1 & P - 2028 Background + Site - AM  
10: Preston & Pepper Square Driveway

Intersection													
Int Delay, s/veh	1.8												
Movement	EBL	EBT	EBR	WBL	WBT	WBR	NBL	NBT	NBR	SBL	SBT	SBR	
Lane Configurations		↔			↔	↔		↔	↔		↔	↔	
Traffic Vol, veh/h	10	3	26	7	1	60	1	52	1898	57	1	16	2090
Future Vol, veh/h	10	3	26	7	1	60	1	52	1898	57	1	16	2090
Conflicting Peds, #/hr	0	0	0	0	0	0	0	0	0	0	0	0	0
Sign Control	Stop	Stop	Stop	Stop	Stop	Free	Free	Free	Free	Free	Free	Free	Free
RT Channelized	-	-	None	-	-	None	-	-	None	-	-	-	None
Storage Length	-	-	-	-	-	0	-	150	-	-	150	-	-
Veh in Median Storage, #	-	1	-	-	1	-	-	0	-	-	0	-	0
Grade, %	-	0	-	-	0	-	-	0	-	-	0	-	-
Peak Hour Factor	89	89	89	89	89	89	89	89	89	89	89	89	89
Heavy Vehicles, %	2	2	2	2	2	2	2	2	2	2	2	2	2
Mvmt Flow	11	3	29	8	1	67	1	58	2133	64	1	18	2348

Major/Minor	Minor2	Minor1	Major1	Major2									
Conflicting Flow All	3396	4739	1212	3262	4745	1099	1770	2424	0	0	1604	2197	0
Stage 1	2424	2424	-	2283	2283	-	-	-	-	-	-	-	-
Stage 2	972	2315	-	979	2462	-	-	-	-	-	-	-	-
Critical Hdwy	6.44	6.54	7.14	6.44	6.54	7.14	5.64	5.34	-	-	5.64	5.34	-
Critical Hdwy Stg 1	7.34	5.54	-	7.34	5.54	-	-	-	-	-	-	-	-
Critical Hdwy Stg 2	6.74	5.54	-	6.74	5.54	-	-	-	-	-	-	-	-
Follow-up Hdwy	3.82	4.02	3.92	3.82	4.02	3.92	2.32	3.12	-	-	2.32	3.12	-
Pot Cap-1 Maneuver	22	~0	*444	*33	~0	178	*751	446	-	-	202	99	-
Stage 1	330	351	-	*24	74	-	-	-	-	-	-	-	-
Stage 2	245	71	-	*456	324	-	-	-	-	-	-	-	-
Platoon blocked, %	1	1	1	1	1	1	1	1	-	-	-	-	-
Mov Cap-1 Maneuver	~11	0	*444	*24	0	178	*449	449	-	-	101	101	-
Mov Cap-2 Maneuver	77	33	-	*19	44	-	-	-	-	-	-	-	-
Stage 1	286	285	-	*21	64	-	-	-	-	-	-	-	-
Stage 2	130	61	-	*341	263	-	-	-	-	-	-	-	-

Approach	EB	WB	NB	SB
HCM Control Delay, s	42	66.7	0.4	0.4
HCM LOS	E	F		

Minor Lane/Major Mvmt	NBL	NBT	NBR	EBLn1	WBLn1	WBLn2	SBL	SBT	SBR
Capacity (veh/h)	449	-	-	140	20	178	101	-	-
HCM Lane V/C Ratio	0.133	-	-	0.313	0.449	0.379	0.189	-	-
HCM Control Delay (s)	14.2	-	-	42	288.6	37.1	49	-	-
HCM Lane LOS	B	-	-	E	F	E	E	-	-
HCM 95th %tile Q(veh)	0.5	-	-	1.2	1.3	1.6	0.7	-	-

Notes  
 ~: Volume exceeds capacity    \$: Delay exceeds 300s    +: Computation Not Defined    \*: All major volume in platoon

Pepper Square TIA  
HCM 6th TWSC

Phase 1 & P - 2028 Background + Site - AM  
20: Preston & Drive 2

Intersection						
Int Delay, s/veh	0.4					
Movement	WBL	WBR	NBT	NBR	SBL	SBT
Lane Configurations		↔	↔	↔		↔
Traffic Vol, veh/h	0	54	1888	38	0	2180
Future Vol, veh/h	0	54	1888	38	0	2180
Conflicting Peds, #/hr	0	0	0	0	0	0
Sign Control	Stop	Stop	Free	Free	Free	Free
RT Channelized	-	None	-	None	-	None
Storage Length	-	0	-	-	-	-
Veh in Median Storage, #	0	-	0	-	-	0
Grade, %	0	-	0	-	-	0
Peak Hour Factor	92	92	92	92	92	92
Heavy Vehicles, %	2	2	2	2	2	2
Mvmt Flow	0	59	2052	41	0	2370

Major/Minor	Minor1	Major1	Major2				
Conflicting Flow All	-	1047	0	0	-	-	-
Stage 1	-	-	-	-	-	-	-
Stage 2	-	-	-	-	-	-	-
Critical Hdwy	-	7.14	-	-	-	-	-
Critical Hdwy Stg 1	-	-	-	-	-	-	-
Critical Hdwy Stg 2	-	-	-	-	-	-	-
Follow-up Hdwy	-	3.92	-	-	-	-	-
Pot Cap-1 Maneuver	0	193	-	-	0	-	-
Stage 1	0	-	-	-	0	-	-
Stage 2	0	-	-	-	0	-	-
Platoon blocked, %	-	-	-	-	-	-	-
Mov Cap-1 Maneuver	-	193	-	-	-	-	-
Mov Cap-2 Maneuver	-	-	-	-	-	-	-
Stage 1	-	-	-	-	-	-	-
Stage 2	-	-	-	-	-	-	-

Approach	WB	NB	SB
HCM Control Delay, s	31.6	0	0
HCM LOS	D		

Minor Lane/Major Mvmt	NBT	NBR	WBLn1	SBT
Capacity (veh/h)	-	-	193	-
HCM Lane V/C Ratio	-	-	0.304	-
HCM Control Delay (s)	-	-	31.6	-
HCM Lane LOS	-	-	D	-
HCM 95th %tile Q(veh)	-	-	1.2	-

Pepper Square TIA  
HCM 6th TWSC

Phase 1 & P - 2028 Background + Site - AM  
21: Preston & Drive 1

Intersection						
Int Delay, s/veh	0					
Movement	WBL	WBR	NBT	NBR	SBL	SBT
Lane Configurations		↑↑↑	↑↑↑			↑↑↑
Traffic Vol, veh/h	0	0	2008	0	0	2122
Future Vol, veh/h	0	0	2008	0	0	2122
Conflicting Peds, #/hr	0	0	0	0	0	0
Sign Control	Stop	Stop	Free	Free	Free	Free
RT Channelized	-	None	-	None	-	None
Storage Length	-	0	-	-	-	-
Veh in Median Storage, #	0	-	0	-	-	0
Grade, %	0	-	0	-	-	0
Peak Hour Factor	92	92	92	92	92	92
Heavy Vehicles, %	2	2	2	2	2	2
Mvmt Flow	0	0	2183	0	0	2307

Major/Minor	Minor1	Major1	Major2		
Conflicting Flow All	-	1092	0	0	-
Stage 1	-	-	-	-	-
Stage 2	-	-	-	-	-
Critical Hdwy	-	7.14	-	-	-
Critical Hdwy Stg 1	-	-	-	-	-
Critical Hdwy Stg 2	-	-	-	-	-
Follow-up Hdwy	-	3.92	-	-	-
Pot Cap-1 Maneuver	0	180	-	-	0
Stage 1	0	-	-	-	0
Stage 2	0	-	-	-	0
Platoon blocked, %	-	-	-	-	-
Mov Cap-1 Maneuver	-	180	-	-	-
Mov Cap-2 Maneuver	-	-	-	-	-
Stage 1	-	-	-	-	-
Stage 2	-	-	-	-	-

Approach	WB	NB	SB
HCM Control Delay, s	0	0	0
HCM LOS	A		

Minor Lane/Major Mvmt	NBT	NBRWBLn1	SBT
Capacity (veh/h)	-	-	-
HCM Lane V/C Ratio	-	-	-
HCM Control Delay (s)	-	0	-
HCM Lane LOS	-	A	-
HCM 95th %tile Q(veh)	-	-	-

Pepper Square TIA  
HCM 6th TWSC

Phase 1 & P - 2028 Background + Site - AM  
22: Drive 6 & Belt Line

Intersection						
Int Delay, s/veh	0					
Movement	EBT	EBR	WBL	WBT	NBL	NBR
Lane Configurations	↑↑↑			↑↑↑		↑
Traffic Vol, veh/h	577	0	0	1178	0	0
Future Vol, veh/h	577	0	0	1178	0	0
Conflicting Peds, #/hr	0	0	0	0	0	0
Sign Control	Free	Free	Free	Free	Stop	Stop
RT Channelized	-	None	-	None	-	None
Storage Length	-	-	-	-	-	0
Veh in Median Storage, #	0	-	-	0	0	-
Grade, %	0	-	-	0	0	-
Peak Hour Factor	96	96	96	96	96	96
Heavy Vehicles, %	2	2	2	2	2	2
Mvmt Flow	601	0	0	1227	0	0

Major/Minor	Major1	Major2	Minor1		
Conflicting Flow All	0	0	-	-	301
Stage 1	-	-	-	-	-
Stage 2	-	-	-	-	-
Critical Hdwy	-	-	-	-	7.14
Critical Hdwy Stg 1	-	-	-	-	-
Critical Hdwy Stg 2	-	-	-	-	-
Follow-up Hdwy	-	-	-	-	3.92
Pot Cap-1 Maneuver	-	-	0	-	0
Stage 1	-	-	0	-	0
Stage 2	-	-	0	-	0
Platoon blocked, %	-	-	-	-	-
Mov Cap-1 Maneuver	-	-	-	-	593
Mov Cap-2 Maneuver	-	-	-	-	-
Stage 1	-	-	-	-	-
Stage 2	-	-	-	-	-

Approach	EB	WB	NB
HCM Control Delay, s	0	0	0
HCM LOS			A

Minor Lane/Major Mvmt	NBLn1	EBT	EBR	WBT
Capacity (veh/h)	-	-	-	-
HCM Lane V/C Ratio	-	-	-	-
HCM Control Delay (s)	0	-	-	-
HCM Lane LOS	A	-	-	-
HCM 95th %tile Q(veh)	-	-	-	-

Pepper Square TIA  
HCM 6th TWSC

Phase 1 & P - 2028 Background + Site - AM  
24: Drive 5 & Belt Line

Intersection						
Int Delay, s/veh	0					
Movement	EBT	EBR	WBL	WBT	NBL	NBR
Lane Configurations	↑↑↑			↑↑↑		↑
Traffic Vol, veh/h	607	0	0	1129	0	0
Future Vol, veh/h	607	0	0	1129	0	0
Conflicting Peds, #/hr	0	0	0	0	0	0
Sign Control	Free	Free	Free	Free	Stop	Stop
RT Channelized	-	None	-	None	-	None
Storage Length	-	-	-	-	-	0
Veh in Median Storage, #	0	-	-	0	0	-
Grade, %	0	-	-	0	0	-
Peak Hour Factor	96	96	96	96	96	96
Heavy Vehicles, %	2	2	2	2	2	2
Mvmt Flow	632	0	0	1176	0	0

Major/Minor	Major1	Major2	Minor1
Conflicting Flow All	0	0	- - - 316
Stage 1	-	-	- - -
Stage 2	-	-	- - -
Critical Hdwy	-	-	- - - 7.14
Critical Hdwy Stg 1	-	-	- - -
Critical Hdwy Stg 2	-	-	- - -
Follow-up Hdwy	-	-	- - - 3.92
Pot Cap-1 Maneuver	-	-	0 - 0 580
Stage 1	-	-	0 - 0 -
Stage 2	-	-	0 - 0 -
Platoon blocked, %	-	-	- - -
Mov Cap-1 Maneuver	-	-	- - - 580
Mov Cap-2 Maneuver	-	-	- - -
Stage 1	-	-	- - -
Stage 2	-	-	- - -

Approach	EB	WB	NB
HCM Control Delay, s	0	0	0
HCM LOS			A

Minor Lane/Major Mvmt	NBLn1	EBT	EBR	WBT
Capacity (veh/h)	-	-	-	-
HCM Lane V/C Ratio	-	-	-	-
HCM Control Delay (s)	0	-	-	-
HCM Lane LOS	A	-	-	-
HCM 95th %tile Q(veh)	-	-	-	-

Pepper Square TIA  
HCM 6th TWSC

Phase 1 & P - 2028 Background + Site - AM  
25: Preston & Drive 4

Intersection						
Int Delay, s/veh	0					
Movement	WBL	WBR	NBT	NBR	SBL	SBT
Lane Configurations		↑↑↑	↑↑↑			↑↑↑
Traffic Vol, veh/h	0	5	1972	3	0	2182
Future Vol, veh/h	0	5	1972	3	0	2182
Conflicting Peds, #/hr	0	0	0	0	0	0
Sign Control	Stop	Stop	Free	Free	Free	Free
RT Channelized	-	None	-	None	-	None
Storage Length	-	0	-	-	-	-
Veh in Median Storage, #	0	-	0	-	-	0
Grade, %	0	-	0	-	-	0
Peak Hour Factor	92	92	92	92	92	92
Heavy Vehicles, %	2	2	2	2	2	2
Mvmt Flow	0	5	2143	3	0	2372

Major/Minor	Minor1	Major1	Major2
Conflicting Flow All	-	1073	0 0 - -
Stage 1	-	-	- - -
Stage 2	-	-	- - -
Critical Hdwy	-	7.14	- - -
Critical Hdwy Stg 1	-	-	- - -
Critical Hdwy Stg 2	-	-	- - -
Follow-up Hdwy	-	3.92	- - -
Pot Cap-1 Maneuver	0	185	- - 0 -
Stage 1	0	-	- - 0 -
Stage 2	0	-	- - 0 -
Platoon blocked, %	-	-	- - -
Mov Cap-1 Maneuver	-	185	- - -
Mov Cap-2 Maneuver	-	-	- - -
Stage 1	-	-	- - -
Stage 2	-	-	- - -

Approach	WB	NB	SB
HCM Control Delay, s	25	0	0
HCM LOS	D		

Minor Lane/Major Mvmt	NBT	NBRWBLn1	SBT
Capacity (veh/h)	-	-	185 -
HCM Lane V/C Ratio	-	-	0.029 -
HCM Control Delay (s)	-	-	25 -
HCM Lane LOS	-	-	D -
HCM 95th %tile Q(veh)	-	-	0.1 -



Intersection						
Int Delay, s/veh	0					
Movement	WBL	WBR	NBT	NBR	SBL	SBT
Lane Configurations		↑↑↑	↑↑↑			↑↑↑
Traffic Vol, veh/h	0	3	1972	0	0	2182
Future Vol, veh/h	0	3	1972	0	0	2182
Conflicting Peds, #/hr	0	0	0	0	0	0
Sign Control	Stop	Stop	Free	Free	Free	Free
RT Channelized	-	None	-	None	-	None
Storage Length	-	0	-	-	-	-
Veh in Median Storage, #	0	-	0	-	-	0
Grade, %	0	-	0	-	-	0
Peak Hour Factor	92	92	92	92	92	92
Heavy Vehicles, %	2	2	2	2	2	2
Mvmt Flow	0	3	2143	0	0	2372

Major/Minor	Minor1	Major1	Major2		
Conflicting Flow All	-	1072	0	0	-
Stage 1	-	-	-	-	-
Stage 2	-	-	-	-	-
Critical Hdwy	-	7.14	-	-	-
Critical Hdwy Stg 1	-	-	-	-	-
Critical Hdwy Stg 2	-	-	-	-	-
Follow-up Hdwy	-	3.92	-	-	-
Pot Cap-1 Maneuver	0	186	-	-	0
Stage 1	0	-	-	-	0
Stage 2	0	-	-	-	0
Platoon blocked, %	-	-	-	-	-
Mov Cap-1 Maneuver	-	186	-	-	-
Mov Cap-2 Maneuver	-	-	-	-	-
Stage 1	-	-	-	-	-
Stage 2	-	-	-	-	-

Approach	WB	NB	SB
HCM Control Delay, s	24.7	0	0
HCM LOS	C		

Minor Lane/Major Mvmt	NBT	NBRWBLn1	SBT
Capacity (veh/h)	-	-	186
HCM Lane V/C Ratio	-	-	0.018
HCM Control Delay (s)	-	-	24.7
HCM Lane LOS	-	-	C
HCM 95th %tile Q(veh)	-	-	0.1

Pepper Square TIA  
Lanes, Volumes, Timings

Phase 1 & P - 2028 Background + Site - PM  
4: Berry Trail & Belt Line

Lane Group	EBL	EBT	EBR	WBL	WBT	WBR	NBL	NBT	NBR	SBL	SBT	SBR
Lane Configurations	↔ ↗ ↘	↔ ↗ ↘	↔ ↗ ↘	↔ ↗ ↘	↔ ↗ ↘	↔ ↗ ↘	↔ ↗ ↘	↔ ↗ ↘	↔ ↗ ↘	↔ ↗ ↘	↔ ↗ ↘	↔ ↗ ↘
Traffic Volume (vph)	40	1165	88	103	841	32	87	9	88	27	6	34
Future Volume (vph)	40	1165	88	103	841	32	87	9	88	27	6	34
Ideal Flow (vphpl)	1900	1900	1900	1900	1900	1900	1900	1900	1900	1900	1900	1900
Storage Length (ft)	150	0	150	0	0	0	0	0	0	0	0	0
Storage Lanes	1	0	1	0	0	1	0	1	0	1	0	0
Taper Length (ft)	25		25		25		25		25		25	
Lane Util. Factor	1.00	0.91	0.91	1.00	0.91	0.91	1.00	1.00	1.00	1.00	1.00	1.00
Frt		0.989			0.995			0.864			0.871	
Fit Protected	0.950			0.950			0.950			0.950		
Satd. Flow (prot)	1770	5029	0	1770	5060	0	1770	1609	0	1770	1622	0
Fit Permitted	0.285			0.175			0.909			0.472		
Satd. Flow (perm)	531	5029	0	326	5060	0	1693	1609	0	879	1622	0
Right Turn on Red		Yes			Yes			Yes			Yes	
Satd. Flow (RTOR)	13			6			94			36		
Link Speed (mph)	42			42			30			30		
Link Distance (ft)	234			493			277			236		
Travel Time (s)	3.8			8.0			6.3			5.4		
Peak Hour Factor	0.94	0.94	0.94	0.94	0.94	0.94	0.94	0.94	0.94	0.94	0.94	0.94
Adj. Flow (vph)	43	1239	94	110	895	34	93	10	94	29	6	36
Shared Lane Traffic (%)												
Lane Group Flow (vph)	43	1333	0	110	929	0	93	104	0	29	42	0
Enter Blocked Intersection	No	No	No	No	No	No	No	No	No	No	No	No
Lane Alignment	Left	Left	Right	Left	Left	Right	Left	Left	Right	Left	Left	Right
Median Width(ft)	12			12			12			12		
Link Offset(ft)	0			0			0			0		
Crosswalk Width(ft)	16			16			16			16		
Two way Left Turn Lane												
Headway Factor	1.00	1.00	1.00	1.00	1.00	1.00	1.00	1.00	1.00	1.00	1.00	1.00
Turning Speed (mph)	15		9	15		9	15		9	15		9
Number of Detectors	1	2		1	2		1	2		1	2	
Detector Template	Left Thru			Left Thru			Left Thru			Left Thru		
Leading Detector (ft)	20	100		20	100		20	100		20	100	
Trailing Detector (ft)	0	0		0	0		0	0		0	0	
Detector 1 Position(ft)	0	0		0	0		0	0		0	0	
Detector 1 Size(ft)	20	6		20	6		20	6		20	6	
Detector 1 Type	Cl+Ex	Cl+Ex		Cl+Ex	Cl+Ex		Cl+Ex	Cl+Ex		Cl+Ex	Cl+Ex	
Detector 1 Channel												
Detector 1 Extend (s)	0.0	0.0		0.0	0.0		0.0	0.0		0.0	0.0	
Detector 1 Queue (s)	0.0	0.0		0.0	0.0		0.0	0.0		0.0	0.0	
Detector 1 Delay (s)	0.0	0.0		0.0	0.0		0.0	0.0		0.0	0.0	
Detector 2 Position(ft)	94			94			94			94		
Detector 2 Size(ft)	6			6			6			6		
Detector 2 Type	Cl+Ex			Cl+Ex			Cl+Ex			Cl+Ex		
Detector 2 Channel												
Detector 2 Extend (s)	0.0			0.0			0.0			0.0		
Turn Type	D,P+P	NA		D,P+P	NA		D,P+P	NA		D,P+P	NA	
Protected Phases	3	8		7	4		1	6		5	2	
Permitted Phases	4			8			2			6		

Pepper Square TIA  
Lanes, Volumes, Timings

Phase 1 & P - 2028 Background + Site - PM  
4: Berry Trail & Belt Line

Lane Group	EBL	EBT	EBR	WBL	WBT	WBR	NBL	NBT	NBR	SBL	SBT	SBR
Detector Phase	3	8		7	4		1	6		5	2	
Switch Phase												
Minimum Initial (s)	4.0	4.0		4.0	4.0		4.0	4.0		4.0	4.0	
Minimum Split (s)	10.0	24.0		10.0	24.0		10.0	31.0		10.0	31.0	
Total Split (s)	15.0	99.0		15.0	99.0		20.0	31.0		15.0	26.0	
Total Split (%)	9.4%	61.9%		9.4%	61.9%		12.5%	19.4%		9.4%	16.3%	
Maximum Green (s)	9.0	93.0		9.0	93.0		14.0	25.0		9.0	20.0	
Yellow Time (s)	4.0	4.0		4.0	4.0		4.0	4.0		4.0	4.0	
All-Red Time (s)	2.0	2.0		2.0	2.0		2.0	2.0		2.0	2.0	
Lost Time Adjust (s)	0.0	0.0		0.0	0.0		0.0	0.0		0.0	0.0	
Total Lost Time (s)	6.0	6.0		6.0	6.0		6.0	6.0		6.0	6.0	
Lead/Lag	Lead	Lag		Lead	Lag		Lead	Lag		Lead	Lag	
Lead-Lag Optimize?	Yes	Yes		Yes	Yes		Yes	Yes		Yes	Yes	
Vehicle Extension (s)	1.0	1.0		1.0	1.0		1.0	1.0		1.0	1.0	
Recall Mode	None	C-Max		None	C-Max		None	None		None	None	
Walk Time (s)		4.0			4.0			4.0			4.0	
Flash Dont Walk (s)		14.0			14.0			21.0			21.0	
Pedestrian Calls (#/hr)		0			0			0			0	
Act Effct Green (s)	123.2	116.2		122.0	119.6		15.2	10.0		15.2	5.2	
Actuated g/C Ratio	0.77	0.73		0.76	0.75		0.10	0.06		0.10	0.03	
v/c Ratio	0.10	0.36		0.37	0.25		0.56	0.55		0.25	0.48	
Control Delay	2.8	3.3		8.3	2.4		75.9	27.0		63.8	44.2	
Queue Delay	0.0	0.0		0.0	0.0		0.0	0.0		0.0	0.0	
Total Delay	2.8	3.3		8.3	2.4		75.9	27.0		63.8	44.2	
LOS	A	A		A	A		E	C		E	D	
Approach Delay		3.3			3.0			50.0			52.2	
Approach LOS		A			A			D			D	
Queue Length 50th (ft)	4	53		5	41		90	10		27	6	
Queue Length 95th (ft)	m6	m62		51	64		145	74		58	50	
Internal Link Dist (ft)		154			413			197			156	
Turn Bay Length (ft)	150			150								
Base Capacity (vph)	490	3657		336	3782		201	330		147	234	
Starvation Cap Reductn	0	0		0	0		0	0		0	0	
Spillback Cap Reductn	0	0		0	0		0	0		0	0	
Storage Cap Reductn	0	0		0	0		0	0		0	0	
Reduced v/c Ratio	0.09	0.36		0.33	0.25		0.46	0.32		0.20	0.18	
Intersection Summary												
Area Type:	Other											
Cycle Length:	160											
Actuated Cycle Length:	160											
Offset:	153 (96%), Referenced to phase 4:EBWB and 8:EBWB, Start of Yellow											
Natural Cycle:	75											
Control Type:	Actuated-Coordinated											
Maximum v/c Ratio:	0.56											
Intersection Signal Delay:	7.9						Intersection LOS: A					
Intersection Capacity Utilization:	56.7%						ICU Level of Service B					
Analysis Period (min):	15											
m Volume for 95th percentile queue is metered by upstream signal.												

Pepper Square TIA  
Lanes, Volumes, Timings

Phase 1 & P - 2028 Background + Site - PM  
4: Berry Trail & Belt Line

Splits and Phases: 4: Berry Trail & Belt Line

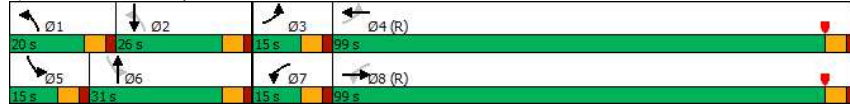

Pepper Square TIA  
Lanes, Volumes, Timings

Phase 1 & P - 2028 Background + Site - PM  
1335: Meadow Creek & Belt Line

	EBL	EBT	EBR	WBL	WBT	WBR	NBL	NBT	NBR	SBL	SBT	SBR
Lane Configurations	↑↑↑ ↑↑↑ ↓ ↓ ↓ ↓ ↓ ↓ ↓ ↓ ↓ ↓ ↓ ↓											
Traffic Volume (vph)	89	1432	45	7	1130	19	19	11	9	12	5	61
Future Volume (vph)	89	1432	45	7	1130	19	19	11	9	12	5	61
Ideal Flow (vphpl)	1900	1900	1900	1900	1900	1900	1900	1900	1900	1900	1900	1900
Storage Length (ft)	150		0	150		0	0		0	0		0
Storage Lanes	1		0	1		0	0		0	0		0
Taper Length (ft)	25			25			25			25		
Lane Util. Factor	1.00	0.91	0.91	1.00	0.91	0.91	1.00	1.00	1.00	1.00	1.00	1.00
Frt		0.995			0.998			0.970				0.895
Fit Protected	0.950			0.950				0.976				0.992
Satd. Flow (prot)	1770	5060	0	1770	5075	0	0	1763	0	0	1654	0
Fit Permitted	0.218			0.149				0.517				0.945
Satd. Flow (perm)	406	5060	0	278	5075	0	0	934	0	0	1575	0
Right Turn on Red			Yes			Yes			Yes			Yes
Satd. Flow (RTOR)		6			3			9				64
Link Speed (mph)	42			42			30					30
Link Distance (ft)		1673			2404		392					423
Travel Time (s)		27.2			39.0		8.9					9.6
Peak Hour Factor	0.95	0.95	0.95	0.95	0.95	0.95	0.95	0.95	0.95	0.95	0.95	0.95
Adj. Flow (vph)	94	1507	47	7	1189	20	20	12	9	13	5	64
Shared Lane Traffic (%)												
Lane Group Flow (vph)	94	1554	0	7	1209	0	0	41	0	0	82	0
Enter Blocked Intersection	No	No	No	No	No	No	No	No	No	No	No	No
Lane Alignment	Left	Left	Right	Left	Left	Right	Left	Left	Right	Left	Left	Right
Median Width(ft)	12			12			0					0
Link Offset(ft)	0			0			0					0
Crosswalk Width(ft)	16			16			16					16
Two way Left Turn Lane												
Headway Factor	1.00	1.00	1.00	1.00	1.00	1.00	1.00	1.00	1.00	1.00	1.00	1.00
Turning Speed (mph)	15		9	15		9	15		9	15		9
Number of Detectors	1	1		1	1		1	1		1		1
Detector Template												
Leading Detector (ft)	50	50		50	50		50	50		50		50
Trailing Detector (ft)	0	0		0	0		0	0		0		0
Detector 1 Position(ft)	0	0		0	0		0	0		0		0
Detector 1 Size(ft)	50	50		50	50		50	50		50		50
Detector 1 Type	Cl+Ex	Cl+Ex		Cl+Ex	Cl+Ex		Cl+Ex	Cl+Ex		Cl+Ex		Cl+Ex
Detector 1 Channel												
Detector 1 Extend (s)	0.0	0.0		0.0	0.0		0.0	0.0		0.0		0.0
Detector 1 Queue (s)	0.0	0.0		0.0	0.0		0.0	0.0		0.0		0.0
Detector 1 Delay (s)	0.0	0.0		0.0	0.0		0.0	0.0		0.0		0.0
Turn Type	Perm	NA		Perm	NA		Perm	NA		Perm		NA
Protected Phases		6			2			4				4
Permitted Phases	6			2			4			4		
Detector Phase	6	6		2	2		4	4		4		4
Switch Phase												
Minimum Initial (s)	12.0	12.0		12.0	12.0		6.0	6.0		6.0		6.0
Minimum Split (s)	17.0	17.0		17.0	17.0		23.5	23.5		23.5		23.5
Total Split (s)	110.0	110.0		110.0	110.0		50.0	50.0		50.0		50.0

Pepper Square TIA  
Lanes, Volumes, Timings

Phase 1 & P - 2028 Background + Site - PM  
1335: Meadow Creek & Belt Line

Lane Group	EBL	EBT	EBR	WBL	WBT	WBR	NBL	NBT	NBR	SBL	SBT	SBR
Total Split (%)	68.8%	68.8%		68.8%	68.8%		31.3%	31.3%		31.3%	31.3%	
Maximum Green (s)	105.0	105.0		105.0	105.0		44.5	44.5		44.5	44.5	
Yellow Time (s)	4.0	4.0		4.0	4.0		3.7	3.7		3.7	3.7	
All-Red Time (s)	1.0	1.0		1.0	1.0		1.8	1.8		1.8	1.8	
Lost Time Adjust (s)	-1.0	-1.0		-1.0	-1.0		-1.5	-1.5		-1.5	-1.5	
Total Lost Time (s)	4.0	4.0		4.0	4.0		4.0	4.0		4.0	4.0	
Lead/Lag												
Lead-Lag Optimize?												
Vehicle Extension (s)	2.0	2.0		2.0	2.0		1.8	1.8		1.8	1.8	
Recall Mode	Min	Min		C-Max	C-Max		None	None		None	None	
Walk Time (s)	4.0	4.0		4.0	4.0		4.0	4.0		4.0	4.0	
Flash Dont Walk (s)	8.0	8.0		8.0	8.0		14.0	14.0		14.0	14.0	
Pedestrian Calls (#/hr)	0	0		0	0		0	0		0	0	
Act Effect Green (s)	142.4	142.4		142.4	142.4		9.6	9.6		9.6	9.6	
Actuated g/C Ratio	0.89	0.89		0.89	0.89		0.06	0.06		0.06	0.06	
v/c Ratio	0.26	0.35		0.03	0.27		0.64	0.64		0.53	0.53	
Control Delay	2.3	0.8		0.1	0.1		99.9	99.9		35.5	35.5	
Queue Delay	0.0	0.0		0.0	0.0		0.0	0.0		0.0	0.0	
Total Delay	2.3	0.8		0.1	0.1		99.9	99.9		35.5	35.5	
LOS	A	A		A	A		F	F		D	D	
Approach Delay		0.9			0.1		99.9	99.9		35.5	35.5	
Approach LOS		A			A		F	F		D	D	
Queue Length 50th (ft)	2	14		0	4		33	33		18	18	
Queue Length 95th (ft)	5	20		m0	m5		78	78		76	76	
Internal Link Dist (ft)		1593			2324		312	312		343	343	
Turn Bay Length (ft)	150			150								
Base Capacity (vph)	361	4504		247	4517		274	274		498	498	
Starvation Cap Reductn	0	0		0	0		0	0		0	0	
Spillback Cap Reductn	0	0		0	0		0	0		0	0	
Storage Cap Reductn	0	0		0	0		0	0		0	0	
Reduced v/c Ratio	0.26	0.35		0.03	0.27		0.15	0.15		0.16	0.16	

Intersection Summary

Area Type:	Other
Cycle Length: 160	
Actuated Cycle Length: 160	
Offset: 73 (46%), Referenced to phase 2:WBTL, Start of Yellow	
Natural Cycle: 60	
Control Type: Actuated-Coordinated	
Maximum v/c Ratio: 0.64	
Intersection Signal Delay: 2.9	Intersection LOS: A
Intersection Capacity Utilization 54.1%	ICU Level of Service A
Analysis Period (min) 15	
m Volume for 95th percentile queue is metered by upstream signal.	

Splits and Phases: 1335: Meadow Creek & Belt Line

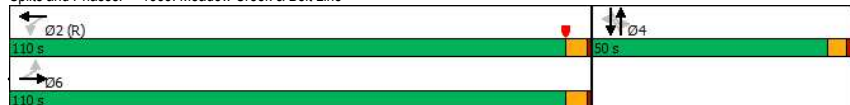

Kimley-Horn

Pepper Square TIA  
Lanes, Volumes, Timings

Phase 1 & P - 2028 Background + Site - PM  
1365: Preston & Araphao

Lane Group	EBU	EBL	EBT	EBR	WBL	WBT	WBR	NBU	NBL	NBT	NBR	SBU
Lane Configurations		↔	↔		↔	↔		↔	↔	↔		
Traffic Volume (vph)	1	276	955	208	185	595	151	3	207	1815	220	5
Future Volume (vph)	1	276	955	208	185	595	151	3	207	1815	220	5
Ideal Flow (vphpl)	1900	1900	1900	1900	1900	1900	1900	1900	1900	1900	1900	1900
Storage Length (ft)		150		0	150		0		300		0	
Storage Lanes		2		0	2		0		2		0	
Taper Length (ft)		25			25				25			
Lane Util. Factor	0.91	0.97	0.91	0.91	0.97	0.91	0.91	0.91	0.97	0.91	0.91	0.91
Frt			0.973		0.970				0.984			
Fit Protected		0.950			0.950				0.950			
Satd. Flow (prot)	0	3433	4948	0	3433	4933	0	0	3433	5004	0	0
Fit Permitted		0.950			0.950				0.950			
Satd. Flow (perm)	0	3433	4948	0	3433	4933	0	0	3433	5004	0	0
Right Turn on Red				Yes		Yes				Yes		
Satd. Flow (RTOR)			31			34					17	
Link Speed (mph)			42			42					42	
Link Distance (ft)			1672			1942					3054	
Travel Time (s)			27.1			31.5					49.6	
Peak Hour Factor	0.93	0.93	0.93	0.93	0.93	0.93	0.93	0.93	0.93	0.93	0.93	0.93
Adj. Flow (vph)	1	297	1027	224	199	640	162	3	223	1952	237	5
Shared Lane Traffic (%)												
Lane Group Flow (vph)	0	298	1251	0	199	802	0	0	226	2189	0	0
Enter Blocked Intersection	No	No	No	No	No	No	No	No	No	No	No	No
Lane Alignment	R NA	Left	Left	Right	Left	Left	Right	R NA	Left	Left	Right	R NA
Median Width(ft)			24			24					24	
Link Offset(ft)			0			0					0	
Crosswalk Width(ft)			16			16					16	
Two way Left Turn Lane												
Headway Factor	1.00	1.00	1.00	1.00	1.00	1.00	1.00	1.00	1.00	1.00	1.00	1.00
Turning Speed (mph)	9	15			9	15			9	15		9
Number of Detectors	1	1	1		1	1			1	1	1	1
Detector Template												
Leading Detector (ft)	50	50	50		50	50			50	50	50	50
Trailing Detector (ft)	0	0	0		0	0			0	0	0	0
Detector 1 Position(ft)	0	0	0		0	0			0	0	0	0
Detector 1 Size(ft)	50	50	50		50	50			50	50	50	50
Detector 1 Type	CI+Ex	CI+Ex	CI+Ex		CI+Ex	CI+Ex			CI+Ex	CI+Ex	CI+Ex	CI+Ex
Detector 1 Channel												
Detector 1 Extend (s)	0.0	0.0	0.0		0.0	0.0			0.0	0.0	0.0	0.0
Detector 1 Queue (s)	0.0	0.0	0.0		0.0	0.0			0.0	0.0	0.0	0.0
Detector 1 Delay (s)	0.0	0.0	0.0		0.0	0.0			0.0	0.0	0.0	0.0
Turn Type	Prot	Prot	NA		Prot	NA			Prot	Prot	NA	Prot
Protected Phases	3	3	8		7	4			1	1	6	5
Permitted Phases												
Detector Phase	3	3	8		7	4			1	1	6	5
Switch Phase												
Minimum Initial (s)	3.0	3.0	18.0		3.0	18.0			3.0	3.0	18.0	3.0
Minimum Split (s)	10.0	10.0	36.7		21.0	36.3			10.0	10.0	35.7	10.0
Total Split (s)	30.0	30.0	53.0		13.0	36.0			24.0	24.0	76.0	18.0

09/26/2022 4:54 pm

Kimley-Horn

Pepper Square TIA  
Lanes, Volumes, Timings

Phase 1 & P - 2028 Background + Site - PM  
1365: Preston & Arapho

Lane Group	SBL	SBT	SBR
Lane Configurations	↑↑	↑↑↑	
Traffic Volume (vph)	215	1426	187
Future Volume (vph)	215	1426	187
Ideal Flow (vphpl)	1900	1900	1900
Storage Length (ft)	250		0
Storage Lanes	2		0
Taper Length (ft)	25		
Lane Util. Factor	0.97	0.91	0.91
Frt		0.983	
Fit Protected	0.950		
Satd. Flow (prot)	3433	4999	0
Fit Permitted	0.950		
Satd. Flow (perm)	3433	4999	0
Right Turn on Red			Yes
Satd. Flow (RTOR)		18	
Link Speed (mph)		48	
Link Distance (ft)		5087	
Travel Time (s)		72.3	
Peak Hour Factor	0.93	0.93	0.93
Adj. Flow (vph)	231	1533	201
Shared Lane Traffic (%)			
Lane Group Flow (vph)	236	1734	0
Enter Blocked Intersection	No	No	No
Lane Alignment	Left	Left	Right
Median Width(ft)		24	
Link Offset(ft)		0	
Crosswalk Width(ft)		16	
Two way Left Turn Lane			
Headway Factor	1.00	1.00	1.00
Turning Speed (mph)	15		9
Number of Detectors	1	1	
Detector Template			
Leading Detector (ft)	50	50	
Trailing Detector (ft)	0	0	
Detector 1 Position(ft)	0	0	
Detector 1 Size(ft)	50	50	
Detector 1 Type	CI+Ex	CI+Ex	
Detector 1 Channel			
Detector 1 Extend (s)	0.0	0.0	
Detector 1 Queue (s)	0.0	0.0	
Detector 1 Delay (s)	0.0	0.0	
Turn Type	Prot	NA	
Protected Phases	5	2	
Permitted Phases			
Detector Phase	5	2	
Switch Phase			
Minimum Initial (s)	3.0	18.0	
Minimum Split (s)	10.0	37.7	
Total Split (s)	18.0	70.0	

Pepper Square TIA  
Lanes, Volumes, Timings

Phase 1 & P - 2028 Background + Site - PM  
1365: Preston & Arapho

Lane Group	EBU	EBL	EBT	EBR	WBL	WBT	WBR	NBU	NBL	NBT	NBR	SBU
Total Split (%)	18.8%	18.8%	33.1%		8.1%	22.5%		15.0%	15.0%	47.5%		11.3%
Maximum Green (s)	24.5	24.5	47.7		7.5	30.7		18.5	18.5	70.3		12.5
Yellow Time (s)	3.0	3.0	4.3		3.0	4.3		3.0	3.0	4.7		3.0
All-Red Time (s)	2.5	2.5	1.0		2.5	1.0		2.5	2.5	1.0		2.5
Lost Time Adjust (s)		-1.0	-1.4		-1.0	-1.0			-1.0	-1.7		
Total Lost Time (s)		4.5	3.9		4.5	4.3			4.5	4.0		
Lead/Lag	Lead	Lead	Lead		Lag	Lag		Lead	Lead	Lead		Lag
Lead-Lag Optimize?	Yes	Yes	Yes		Yes	Yes		Yes	Yes	Yes		Yes
Vehicle Extension (s)	0.8	0.8	2.5		0.8	1.8		1.5	1.5	1.7		1.5
Recall Mode	None	None	Max		None	None		None	None	Max		None
Walk Time (s)			4.0			4.0				4.0		
Flash Dont Walk (s)			27.0			27.0				26.0		
Pedestrian Calls (#/hr)			0			0				0		
Act Effect Green (s)		18.1	49.1		8.5	39.1			15.4	72.0		
Actuated g/C Ratio		0.11	0.31		0.05	0.24			0.10	0.45		
v/c Ratio		0.77	0.81		1.09	0.65			0.69	0.97		
Control Delay		81.3	54.2		152.9	50.3			96.1	29.0		
Queue Delay		0.0	0.0		0.0	0.0			0.0	0.0		
Total Delay		81.3	54.2		152.9	50.3			96.1	29.0		
LOS		F	D		F	D			F	C		
Approach Delay			59.4			70.7				35.3		
Approach LOS			E			E				D		
Queue Length 50th (ft)			159		-121	243			109	195		
Queue Length 95th (ft)			206		#209	274			m122	m#219		
Internal Link Dist (ft)			1592			1862				2974		
Turn Bay Length (ft)			150			150			300			
Base Capacity (vph)			547		1539	182		1231		418		2261
Starvation Cap Reductn			0		0	0		0		0		0
Spillback Cap Reductn			0		0	0		0		0		0
Storage Cap Reductn			0		0	0		0		0		0
Reduced v/c Ratio			0.54		0.81	1.09		0.65		0.54		0.97
<b>Intersection Summary</b>												
Area Type:	Other											
Cycle Length:	160											
Actuated Cycle Length:	160											
Offset:	120 (75%), Referenced to phase 2:SBT, Start of Yellow											
Natural Cycle:	140											
Control Type:	Actuated-Coordinated											
Maximum v/c Ratio:	1.09											
Intersection Signal Delay:	47.5											
Intersection LOS:	D											
Intersection Capacity Utilization:	88.8%											
ICU Level of Service:	E											
Analysis Period (min):	15											
~	Volume exceeds capacity, queue is theoretically infinite. Queue shown is maximum after two cycles.											
#	95th percentile volume exceeds capacity, queue may be longer. Queue shown is maximum after two cycles.											
m	Volume for 95th percentile queue is metered by upstream signal.											

Pepper Square TIA  
Lanes, Volumes, Timings

Phase 1 & P - 2028 Background + Site - PM  
1365: Preston & Arapaho

Splits and Phases: 1365: Preston & Arapaho



Pepper Square TIA  
Lanes, Volumes, Timings

Phase 1 & P - 2028 Background + Site - PM  
1365: Preston & Arapaho

Lane Group	SBL	SBT	SBR
Total Split (%)	11.3%	43.8%	
Maximum Green (s)	12.5	64.3	
Yellow Time (s)	3.0	4.7	
All-Red Time (s)	2.5	1.0	
Lost Time Adjust (s)	-1.0	-1.7	
Total Lost Time (s)	4.5	4.0	
Lead/Lag	Lag	Lag	
Lead-Lag Optimize?	Yes	Yes	
Vehicle Extension (s)	1.5	1.5	
Recall Mode	None	C-Max	
Walk Time (s)		4.0	
Flash Dont Walk (s)		28.0	
Pedestrian Calls (#/hr)		0	
Act Effect Green (s)	13.5	70.1	
Actuated g/C Ratio	0.08	0.44	
v/c Ratio	0.82	0.79	
Control Delay	80.0	36.0	
Queue Delay	0.0	0.0	
Total Delay	80.0	36.0	
LOS	E	D	
Approach Delay		41.2	
Approach LOS		D	
Queue Length 50th (ft)	128	569	
Queue Length 95th (ft)	m154	636	
Internal Link Dist (ft)		5007	
Turn Bay Length (ft)	250		
Base Capacity (vph)	289	2201	
Starvation Cap Reductn	0	0	
Spillback Cap Reductn	0	0	
Storage Cap Reductn	0	0	
Reduced v/c Ratio	0.82	0.79	
<b>Intersection Summary</b>			

Pepper Square TIA  
Lanes, Volumes, Timings

Phase 1 & P - 2028 Background + Site - PM  
1367: Preston & Belt Line



Lane Group	EBU	EBL	EBT	EBR	WBU	WBL	WBT	WBR	NBL	NBT	NBR	SBU
Lane Configurations												
Traffic Volume (vph)	46	365	1041	407	1	103	679	133	505	1913	62	2
Future Volume (vph)	46	365	1041	407	1	103	679	133	505	1913	62	2
Ideal Flow (vphpl)	1900	1900	1900	1900	1900	1900	1900	1900	1900	1900	1900	1900
Storage Length (ft)		150		150		200		0	250		0	
Storage Lanes		2		1		1		0	2		0	
Taper Length (ft)		25				25			25			
Lane Util. Factor	0.91	0.97	0.91	1.00	0.91	1.00	0.91	0.91	0.97	0.91	0.91	0.91
Frt			0.850				0.975			0.995		
Fit Protected		0.950				0.950			0.950			
Satd. Flow (prot)	0	3433	5085	1583	0	1770	4958	0	3433	5060	0	0
Fit Permitted		0.950				0.950			0.950			
Satd. Flow (perm)	0	3433	5085	1583	0	1770	4958	0	3433	5060	0	0
Right Turn on Red				Yes			Yes		Yes		Yes	
Satd. Flow (RTOR)				236			21		4			
Link Speed (mph)			42				42		42			
Link Distance (ft)			925				394		261			
Travel Time (s)			15.0				6.4		4.2			
Peak Hour Factor	0.96	0.96	0.96	0.96	0.96	0.96	0.96	0.96	0.96	0.96	0.96	0.96
Adj. Flow (vph)	48	380	1084	424	1	107	707	139	526	1993	65	2
Shared Lane Traffic (%)												
Lane Group Flow (vph)	0	428	1084	424	0	108	846	0	526	2058	0	0
Enter Blocked Intersection	No	No	No	No	No	No	No	No	No	No	No	No
Lane Alignment	R NA	Left	Left	Right	R NA	Left	Right	Left	Left	Right	R NA	
Median Width(ft)			24				24		24			
Link Offset(ft)			0				0		0			
Crosswalk Width(ft)			16				16		16			
Two way Left Turn Lane												
Headway Factor	1.00	1.00	1.00	1.00	1.00	1.00	1.00	1.00	1.00	1.00	1.00	1.00
Turning Speed (mph)	9	15		9	9	15		9	15		9	9
Number of Detectors	1	1	1	1	1	1	1	1	1	1	1	1
Detector Template												
Leading Detector (ft)	50	50	50	50	50	50	50	50	50	50	50	50
Trailing Detector (ft)	0	0	0	0	0	0	0	0	0	0	0	0
Detector 1 Position(ft)	0	0	0	0	0	0	0	0	0	0	0	0
Detector 1 Size(ft)	50	50	50	50	50	50	50	50	50	50	50	50
Detector 1 Type	CI+Ex	CI+Ex	CI+Ex	CI+Ex	CI+Ex	CI+Ex	CI+Ex	CI+Ex	CI+Ex	CI+Ex	CI+Ex	CI+Ex
Detector 1 Channel												
Detector 1 Extend (s)	0.0	0.0	0.0	0.0	0.0	0.0	0.0	0.0	0.0	0.0	0.0	0.0
Detector 1 Queue (s)	0.0	0.0	0.0	0.0	0.0	0.0	0.0	0.0	0.0	0.0	0.0	0.0
Detector 1 Delay (s)	0.0	0.0	0.0	0.0	0.0	0.0	0.0	0.0	0.0	0.0	0.0	0.0
Turn Type	Prot	Prot	NA	Perm	Prot	Prot	NA	Prot	NA	Prot	NA	Prot
Protected Phases	3 13	3 13	8		17	17	4		1 11	6		5
Permitted Phases				8								
Detector Phase	3 13	3 13	8	8	17	17	4		1 11	6		5
Switch Phase												
Minimum Initial (s)			18.0	18.0	3.0	3.0	18.0		18.0			3.0
Minimum Split (s)			32.5	32.5	8.0	8.0	32.5		33.0			11.0
Total Split (s)			50.0	50.0	14.0	14.0	27.0		77.0			19.0

Pepper Square TIA  
Lanes, Volumes, Timings

Phase 1 & P - 2028 Background + Site - PM  
1367: Preston & Belt Line



Lane Group	SBL	SBT	SBR	Ø1	Ø3	Ø11	Ø13
Lane Configurations							
Traffic Volume (vph)	166	1447	267				
Future Volume (vph)	166	1447	267				
Ideal Flow (vphpl)	1900	1900	1900				
Storage Length (ft)	200		300				
Storage Lanes	1		1				
Taper Length (ft)	25						
Lane Util. Factor	1.00	0.91	1.00				
Frt			0.850				
Fit Protected	0.950						
Satd. Flow (prot)	1770	5085	1583				
Fit Permitted	0.950						
Satd. Flow (perm)	1770	5085	1583				
Right Turn on Red			Yes				
Satd. Flow (RTOR)			226				
Link Speed (mph)		40					
Link Distance (ft)		3054					
Travel Time (s)		52.1					
Peak Hour Factor	0.96	0.96	0.96				
Adj. Flow (vph)	173	1507	278				
Shared Lane Traffic (%)							
Lane Group Flow (vph)	175	1507	278				
Enter Blocked Intersection	No	No	No				
Lane Alignment	Left	Left	Right				
Median Width(ft)		24					
Link Offset(ft)		0					
Crosswalk Width(ft)		16					
Two way Left Turn Lane							
Headway Factor	1.00	1.00	1.00				
Turning Speed (mph)	15		9				
Number of Detectors	1	1	1				
Detector Template							
Leading Detector (ft)	50	50	50				
Trailing Detector (ft)	0	0	0				
Detector 1 Position(ft)	0	0	0				
Detector 1 Size(ft)	50	50	50				
Detector 1 Type	CI+Ex	CI+Ex	CI+Ex				
Detector 1 Channel							
Detector 1 Extend (s)	0.0	0.0	0.0				
Detector 1 Queue (s)	0.0	0.0	0.0				
Detector 1 Delay (s)	0.0	0.0	0.0				
Turn Type	Prot	NA	Perm				
Protected Phases	5	2		1	3	11	13
Permitted Phases			2				
Detector Phase	5	2	2				
Switch Phase							
Minimum Initial (s)	3.0	18.0	18.0	3.0	3.0	3.0	3.0
Minimum Split (s)	11.0	33.0	33.0	8.0	11.0	8.0	11.0
Total Split (s)	19.0	60.0	60.0	16.0	20.0	20.0	17.0

Pepper Square TIA  
Lanes, Volumes, Timings

Phase 1 & P - 2028 Background + Site - PM  
1367: Preston & Belt Line

Lane Group	EBU	EBL	EBT	EBR	WBU	WBL	WBT	WBR	NBL	NBT	NBR	SBU
Total Split (%)		31.3%	31.3%	8.8%	8.8%	16.9%				48.1%		11.9%
Maximum Green (s)		44.5	44.5	9.0	9.0	21.5				71.0		14.0
Yellow Time (s)		4.0	4.0	3.0	3.0	4.0				4.4		3.0
All-Red Time (s)		1.5	1.5	2.0	2.0	1.5				1.6		2.0
Lost Time Adjust (s)		-1.5	-1.5		-1.0	-1.5				-1.7		
Total Lost Time (s)		4.0	4.0		4.0	4.0				4.3		
Lead/Lag							Lag			Lag		Lead
Lead-Lag Optimize?							Yes			Yes		Yes
Vehicle Extension (s)		1.3	1.3	3.0	3.0	1.3				2.0		1.5
Recall Mode		Max	Max	None	None	Max			C-Max			None
Walk Time (s)		7.0	7.0			7.0				7.0		
Flash Dont Walk (s)		20.0	20.0			20.0				20.0		
Pedestrian Calls (#/hr)		0	0			0				0		
Act Effect Green (s)		28.7	46.0	46.0		10.0	23.3		28.0	72.7		
Actuated g/C Ratio		0.18	0.29	0.29		0.06	0.15		0.18	0.45		
v/c Ratio		0.70	0.74	0.68		0.98	1.14		0.88	0.89		
Control Delay		57.6	61.4	35.9		133.1	109.4		55.9	24.5		
Queue Delay		0.0	0.0	0.0		0.0	0.0		0.0	2.7		
Total Delay		57.6	61.4	35.9		133.1	109.4		55.9	27.2		
LOS		E	E	D		F	F		E	C		
Approach Delay			55.0				112.1			33.1		
Approach LOS			D				F			C		
Queue Length 50th (ft)		180	405	214		120	-364		222	697		
Queue Length 95th (ft)		252	460	377		#254	#458		#313	642		
Internal Link Dist (ft)			845				314			181		
Turn Bay Length (ft)		150		150		200			250			
Base Capacity (vph)		622	1461	623		110	740		600	2301		
Starvation Cap Reductn		0	0	0		0	0		0	153		
Spillback Cap Reductn		0	0	0		0	0		0	0		
Storage Cap Reductn		0	0	0		0	0		0	0		
Reduced v/c Ratio		0.69	0.74	0.68		0.98	1.14		0.88	0.96		

Intersection Summary

Area Type:	Other
Cycle Length:	160
Actuated Cycle Length:	160
Offset:	56 (35%), Referenced to phase 6:NBT, Start of Yellow
Natural Cycle:	125
Control Type:	Actuated-Coordinated
Maximum v/c Ratio:	1.14
Intersection Signal Delay:	52.4
Intersection LOS:	D
Intersection Capacity Utilization:	89.0%
ICU Level of Service:	E
Analysis Period (min):	15
~	Volume exceeds capacity, queue is theoretically infinite. Queue shown is maximum after two cycles.
#	95th percentile volume exceeds capacity, queue may be longer. Queue shown is maximum after two cycles.
m	Volume for 95th percentile queue is metered by upstream signal.

Pepper Square TIA  
Lanes, Volumes, Timings

Phase 1 & P - 2028 Background + Site - PM  
1367: Preston & Belt Line

Splits and Phases: 1367: Preston & Belt Line





Pepper Square TIA  
Lanes, Volumes, Timings

Phase 1 & P - 2028 Background + Site - PM  
1367: Preston & Belt Lane

Lane Group	SBL	SBT	SBR	Ø1	Ø3	Ø11	Ø13
Total Split (%)	11.9%	37.5%	37.5%	10%	13%	13%	11%
Maximum Green (s)	14.0	54.0	54.0	11.0	15.0	15.0	12.0
Yellow Time (s)	3.0	4.4	4.4	3.0	3.0	3.0	3.0
All-Red Time (s)	2.0	1.6	1.6	2.0	2.0	2.0	2.0
Lost Time Adjust (s)	-1.0	-1.7	-1.7				
Total Lost Time (s)	4.0	4.3	4.3				
Lead/Lag	Lead	Lag	Lag	Lead	Lead		
Lead-Lag Optimize?	Yes	Yes	Yes	Yes	Yes		
Vehicle Extension (s)	1.5	2.5	2.5	1.6	1.3	3.0	3.0
Recall Mode	None	Max	Max	None	None	None	None
Walk Time (s)		7.0	7.0				
Flash Dont Walk (s)		20.0	20.0				
Pedestrian Calls (#/hr)		0	0				
Act Effect Green (s)	15.0	55.7	55.7				
Actuated g/C Ratio	0.09	0.35	0.35				
v/c Ratio	1.06	0.85	0.40				
Control Delay	124.7	43.9	10.4				
Queue Delay	0.0	0.0	0.0				
Total Delay	124.7	43.9	10.4				
LOS	F	D	B				
Approach Delay		46.4					
Approach LOS		D					
Queue Length 50th (ft)	~192	584	134				
Queue Length 95th (ft)	m#284	m632	m137				
Internal Link Dist (ft)		2974					
Turn Bay Length (ft)	200		300				
Base Capacity (vph)	165	1770	698				
Starvation Cap Reductn	0	0	0				
Spillback Cap Reductn	0	0	0				
Storage Cap Reductn	0	0	0				
Reduced v/c Ratio	1.06	0.85	0.40				

Intersection Summary

Pepper Square TIA  
Lanes, Volumes, Timings

Phase 1 & P - 2028 Background + Site - PM  
1368: Preston & Alexis

Lane Group	EBL	EBT	EBR	WBL	WBT	WBR	NBU	NBL	NBT	NBR	SBL	SBT
Lane Configurations												
Traffic Volume (vph)	66	24	64	265	24	90	7	43	2357	270	189	1673
Future Volume (vph)	66	24	64	265	24	90	7	43	2357	270	189	1673
Ideal Flow (vphpl)	1900	1900	1900	1900	1900	1900	1900	1900	1900	1900	1900	1900
Storage Length (ft)	0		0	175		0		150		150	150	
Storage Lanes	1		1	2		1		1		1	1	
Taper Length (ft)	25			25				25			25	
Lane Util. Factor	0.91	0.91	1.00	0.97	1.00	1.00	0.91	1.00	0.91	1.00	1.00	0.91
Frt			0.850			0.850				0.850		
Fit Protected	0.950	0.972		0.950				0.950			0.950	
Satd. Flow (prot)	1610	3295	1583	3433	1863	1583	0	1770	5085	1583	1770	5085
Fit Permitted	0.950	0.972		0.950				0.099			0.040	
Satd. Flow (perm)	1610	3295	1583	3433	1863	1583	0	184	5085	1583	75	5085
Right Turn on Red			Yes			Yes				Yes		
Satd. Flow (RTOR)			125			93				111		
Link Speed (mph)		30			30			43				42
Link Distance (ft)		660			627			2867				173
Travel Time (s)		15.0			14.3			45.5				2.8
Peak Hour Factor	0.95	0.95	0.95	0.95	0.95	0.95	0.95	0.95	0.95	0.95	0.95	0.95
Adj. Flow (vph)	69	25	67	279	25	95	7	45	2481	284	199	1761
Shared Lane Traffic (%)	50%											
Lane Group Flow (vph)	34	60	67	279	25	95	0	52	2481	284	199	1761
Enter Blocked Intersection	No	No	No	No	No	No	No	No	No	No	No	No
Lane Alignment	Left	Left	Right	Left	Left	Right	R NA	Left	Left	Right	Left	Left
Median Width(ft)	24			24				12				12
Link Offset(ft)	0			0				0				0
Crosswalk Width(ft)	16			16				16				16
Two way Left Turn Lane												
Headway Factor	1.00	1.00	1.00	1.00	1.00	1.00	1.00	1.00	1.00	1.00	1.00	1.00
Turning Speed (mph)	15		9	15		9	9	15		9	15	
Number of Detectors	1	1	1	1	1	1	1	1	1	1	1	1
Detector Template												
Leading Detector (ft)	50	50	50	50	50	50	50	50	50	50	50	50
Trailing Detector (ft)	0	0	0	0	0	0	0	0	0	0	0	0
Detector 1 Position(ft)	0	0	0	0	0	0	0	0	0	0	0	0
Detector 1 Size(ft)	50	50	50	50	50	50	50	50	50	50	50	50
Detector 1 Type	Cl+Ex	Cl+Ex	Cl+Ex	Cl+Ex	Cl+Ex	Cl+Ex	Cl+Ex	Cl+Ex	Cl+Ex	Cl+Ex	Cl+Ex	Cl+Ex
Detector 1 Channel												
Detector 1 Extend (s)	0.0	0.0	0.0	0.0	0.0	0.0	0.0	0.0	0.0	0.0	0.0	0.0
Detector 1 Queue (s)	0.0	0.0	0.0	0.0	0.0	0.0	0.0	0.0	0.0	0.0	0.0	0.0
Detector 1 Delay (s)	0.0	0.0	0.0	0.0	0.0	0.0	0.0	0.0	0.0	0.0	0.0	0.0
Turn Type	Split	NA	Perm	Split	NA	pm+ov	D,P+P	D,P+P	NA	Perm	D,P+P	NA
Permitted Phases	3	3		4	4	5	1	1	6		5	2
Permitted Phases			3		4	2	2			6	6	
Detector Phase	3	3	3	4	4	5	1	1	6	6	5	2
Switch Phase												
Minimum Initial (s)	6.0	6.0	6.0	8.0	8.0	3.0	3.0	3.0	14.0	14.0	3.0	14.0
Minimum Split (s)	27.0	27.0	27.0	27.0	27.0	8.4	8.4	8.4	24.0	24.0	8.4	24.0
Total Split (s)	23.0	23.0	23.0	22.0	22.0	20.0	15.0	15.0	95.0	95.0	20.0	100.0

Pepper Square TIA  
Lanes, Volumes, Timings

Phase 1 & P - 2028 Background + Site - PM  
1368: Preston & Alexis

Lane Group	SBR
Left Configurations	↑
Traffic Volume (vph)	23
Future Volume (vph)	23
Ideal Flow (vphpl)	1900
Storage Length (ft)	150
Storage Lanes	1
Taper Length (ft)	
Lane Util. Factor	1.00
Frt	0.850
Fit Protected	
Satd. Flow (prot)	1583
Fit Permitted	
Satd. Flow (perm)	1583
Right Turn on Red	Yes
Satd. Flow (RTOR)	78
Link Speed (mph)	
Link Distance (ft)	
Travel Time (s)	
Peak Hour Factor	0.95
Adj. Flow (vph)	24
Shared Lane Traffic (%)	
Lane Group Flow (vph)	24
Enter Blocked Intersection	No
Lane Alignment	Right
Median Width(ft)	
Link Offset(ft)	
Crosswalk Width(ft)	
Two way Left Turn Lane	
Headway Factor	1.00
Turning Speed (mph)	9
Number of Detectors	1
Detector Template	
Leading Detector (ft)	50
Trailing Detector (ft)	0
Detector 1 Position(ft)	0
Detector 1 Size(ft)	50
Detector 1 Type	CI+Ex
Detector 1 Channel	
Detector 1 Extend (s)	0.0
Detector 1 Queue (s)	0.0
Detector 1 Delay (s)	0.0
Turn Type	Perm
Protected Phases	
Permitted Phases	2
Detector Phase	2
Switch Phase	
Minimum Initial (s)	14.0
Minimum Split (s)	24.0
Total Split (s)	100.0

09/26/2022 4:54 pm  
Kimley-Horn

Synchro 11 Report  
Page 17

Pepper Square TIA  
Lanes, Volumes, Timings

Phase 1 & P - 2028 Background + Site - PM  
1368: Preston & Alexis

Lane Group	EBL	EBT	EBR	WBL	WBT	WBR	NBU	NBL	NBT	NBR	SBL	SBT
Total Split (%)	14.4%	14.4%	14.4%	13.8%	13.8%	12.5%	9.4%	9.4%	59.4%	59.4%	12.5%	62.5%
Maximum Green (s)	18.0	18.0	18.0	17.0	17.0	15.6	10.6	10.6	89.0	89.0	15.6	94.0
Yellow Time (s)	4.0	4.0	4.0	4.0	4.0	3.4	3.4	3.4	4.5	4.5	3.4	4.5
All-Red Time (s)	1.0	1.0	1.0	1.0	1.0	1.0	1.0	1.0	1.5	1.5	1.0	1.5
Lost Time Adjust (s)	-1.0	-1.0	0.0	-1.0	-1.0	0.0			-1.0	-2.0	0.0	-1.0
Total Lost Time (s)	4.0	4.0	5.0	4.0	4.0	4.4			3.4	4.0	6.0	3.4
Lead/Lag	Lag	Lag	Lag	Lead	Lead	Lag	Lead	Lead	Lead	Lead	Lag	Lag
Lead-Lag Optimize?	Yes	Yes	Yes	Yes	Yes	Yes	Yes	Yes	Yes	Yes	Yes	Yes
Vehicle Extension (s)	2.0	2.0	2.0	2.0	2.0	1.2	1.2	1.2	2.5	2.5	1.2	2.5
Recall Mode	None	None	None	None	None	None	None	None	Max	Max	None	C-Max
Walk Time (s)	4.0	4.0	4.0	4.0	4.0				4.0	4.0		4.0
Flash Dont Walk (s)	18.0	18.0	18.0	18.0	18.0				14.0	14.0		14.0
Pedestrian Calls (#/hr)	0	0	0	0	0				0	0		0
Act Effect Green (s)	9.1	9.1	8.1	16.8	16.8	36.4			119.9	102.1	100.1	119.3
Actuated g/C Ratio	0.06	0.06	0.05	0.10	0.10	0.23			0.75	0.64	0.63	0.75
v/c Ratio	0.37	0.32	0.34	0.78	0.13	0.22			0.27	0.77	0.28	0.86
Control Delay	83.4	76.3	4.5	84.8	65.9	10.2			8.0	19.4	6.8	60.7
Queue Delay	0.0	0.0	0.0	0.0	0.0	0.0			0.0	0.0	0.0	0.0
Total Delay	83.4	76.3	4.5	84.8	65.9	10.2			8.0	19.4	6.8	60.7
LOS	F	E	A	F	E	B			A	B	A	E
Approach Delay			47.9			65.8				17.9		9.1
Approach LOS			D			E				B		A
Queue Length 50th (ft)	38	34	0	147	24	2			11	590	49	163
Queue Length 95th (ft)	80	60	0	200	57	51			21	749	83	#307
Internal Link Dist (ft)			580			547				2787		93
Turn Bay Length (ft)					175				150		150	
Base Capacity (vph)	191	391	289	386	209	432			256	3243	1031	231
Starvation Cap Reductn	0	0	0	0	0	0			0	0	0	0
Spillback Cap Reductn	0	0	0	0	0	0			0	0	0	0
Storage Cap Reductn	0	0	0	0	0	0			0	0	0	0
Reduced v/c Ratio	0.18	0.15	0.23	0.72	0.12	0.22			0.20	0.77	0.28	0.86

Intersection Summary

Area Type: Other  
 Cycle Length: 160  
 Actuated Cycle Length: 160  
 Offset: 63 (39%), Referenced to phase 2:NBSB, Start of Yellow  
 Natural Cycle: 140  
 Control Type: Actuated-Coordinated  
 Maximum v/c Ratio: 0.86  
 Intersection Signal Delay: 19.1  
 Intersection LOS: B  
 Intersection Capacity Utilization 80.2%  
 ICU Level of Service D  
 Analysis Period (min) 15  
 # 95th percentile volume exceeds capacity, queue may be longer.  
 Queue shown is maximum after two cycles.  
 m Volume for 95th percentile queue is metered by upstream signal.

Splits and Phases: 1368: Preston & Alexis

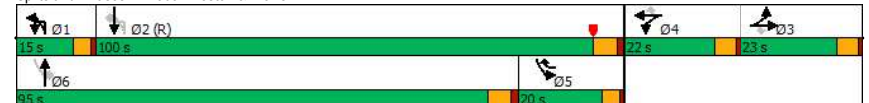

Pepper Square TIA  
Lanes, Volumes, Timings

Phase 1 & P - 2028 Background + Site - PM  
1368: Preston & Alexis

Lane Group	SBR
Total Split (%)	62.5%
Maximum Green (s)	94.0
Yellow Time (s)	4.5
All-Red Time (s)	1.5
Lost Time Adjust (s)	0.0
Total Lost Time (s)	6.0
Lead/Lag	Lag
Lead-Lag Optimize?	Yes
Vehicle Extension (s)	2.5
Recall Mode	C-Max
Walk Time (s)	4.0
Flash Dont Walk (s)	14.0
Pedestrian Calls (#/hr)	0
Act Effect Green (s)	112.5
Actuated g/C Ratio	0.70
v/c Ratio	0.02
Control Delay	0.0
Queue Delay	0.0
Total Delay	0.0
LOS	A
Approach Delay	
Approach LOS	
Queue Length 50th (ft)	0
Queue Length 95th (ft)	m0
Internal Link Dist (ft)	
Turn Bay Length (ft)	150
Base Capacity (vph)	1135
Starvation Cap Reductn	0
Spillback Cap Reductn	0
Storage Cap Reductn	0
Reduced v/c Ratio	0.02

Intersection Summary

Pepper Square TIA  
Lanes, Volumes, Timings

Phase 1 & P - 2028 Background + Site - PM  
1369: Preston & Belt Line Village Driveway

Lane Group	EBL	EBT	EBR	WBL	WBT	WBR	NBU	NBL	NBT	NBR	SBU	SBL
Lane Configurations		↕↕		↕	↕			↕	↕↕↕			↕
Traffic Volume (vph)	80	5	54	88	6	51	1	67	2280	44	8	132
Future Volume (vph)	80	5	54	88	6	51	1	67	2280	44	8	132
Ideal Flow (vphpl)	1900	1900	1900	1900	1900	1900	1900	1900	1900	1900	1900	1900
Storage Length (ft)	0		0	0		0		100		0		100
Storage Lanes	0		0	1		0		1		0		1
Taper Length (ft)	25			25				25				25
Lane Util. Factor	0.95	0.95	0.95	1.00	1.00	1.00	0.91	1.00	0.91	0.91	0.91	1.00
Fr		0.941				0.865			0.997			
Fit Protected		0.972		0.950				0.950				0.950
Satd. Flow (prot)	0	3237	0	1770	1611	0	0	1770	5070	0	0	1770
Fit Permitted		0.757		0.591				0.077				0.041
Satd. Flow (perm)	0	2521	0	1101	1611	0	0	143	5070	0	0	76
Right Turn on Red			Yes			Yes				Yes		
Satd. Flow (RTOR)		56			53				3			
Link Speed (mph)		30			30				42			
Link Distance (ft)		303			249				252			
Travel Time (s)		6.9			5.7				4.1			
Peak Hour Factor	0.97	0.97	0.97	0.97	0.97	0.97	0.97	0.97	0.97	0.97	0.97	0.97
Adj. Flow (vph)	82	5	56	91	6	53	1	69	2351	45	8	136
Shared Lane Traffic (%)												
Lane Group Flow (vph)	0	143	0	91	59	0	0	70	2396	0	0	144
Enter Blocked Intersection	No	No	No	No	No	No	No	No	No	No	No	No
Lane Alignment	Left	Left	Right	Left	Left	Right	R NA	Left	Left	Right	R NA	Left
Median Width(ft)		12			12				12			
Link Offset(ft)		0			0				0			
Crosswalk Width(ft)		16			16				16			
Two way Left Turn Lane												
Headway Factor	1.00	1.00	1.00	1.00	1.00	1.00	1.00	1.00	1.00	1.00	1.00	1.00
Turning Speed (mph)	15		9	15		9	9	15		9	9	15
Number of Detectors	1	1		1	1		1	1	1		1	1
Detector Template												
Leading Detector (ft)	50	50		50	50		50	50	50		50	50
Trailing Detector (ft)	0	0		0	0		0	0	0		0	0
Detector 1 Position(ft)	0	0		0	0		0	0	0		0	0
Detector 1 Size(ft)	50	50		50	50		50	50	50		50	50
Detector 1 Type	CI+Ex	CI+Ex		CI+Ex	CI+Ex		CI+Ex	CI+Ex	CI+Ex		CI+Ex	CI+Ex
Detector 1 Channel												
Detector 1 Extend (s)	0.0	0.0		0.0	0.0		0.0	0.0	0.0		0.0	0.0
Detector 1 Queue (s)	0.0	0.0		0.0	0.0		0.0	0.0	0.0		0.0	0.0
Detector 1 Delay (s)	0.0	0.0		0.0	0.0		0.0	0.0	0.0		0.0	0.0
Turn Type	Perm	NA		Perm	NA		custom	D,P+P	NA		custom	D,P+P
Protected Phases		8			4			1	6			5
Permitted Phases	8			4			1	2			5	6
Detector Phase	8	8		4	4		1	1	6		5	5
Switch Phase												
Minimum Initial (s)	20.0	20.0		20.0	20.0		5.0	5.0	20.0		5.0	5.0
Minimum Split (s)	25.0	25.0		25.0	25.0		10.0	10.0	26.0		10.0	10.0
Total Split (s)	47.0	47.0		47.0	47.0		20.0	20.0	98.0		15.0	15.0

Pepper Square TIA  
Lanes, Volumes, Timings

Phase 1 & P - 2028 Background + Site - PM  
1369: Preston & Belt Line Village Driveway

Lane Group	SBT	SBR
Lane Configurations	↑↑↑	↔
Traffic Volume (vph)	1892	26
Future Volume (vph)	1892	26
Ideal Flow (vphpl)	1900	1900
Storage Length (ft)		0
Storage Lanes		0
Taper Length (ft)		
Lane Util. Factor	0.91	0.91
Frt	0.998	
Fit Protected		
Satd. Flow (prot)	5075	0
Fit Permitted		
Satd. Flow (perm)	5075	0
Right Turn on Red		Yes
Satd. Flow (RTOR)	2	
Link Speed (mph)	38	
Link Distance (ft)	191	
Travel Time (s)	3.4	
Peak Hour Factor	0.97	0.97
Adj. Flow (vph)	1951	27
Shared Lane Traffic (%)		
Lane Group Flow (vph)	1978	0
Enter Blocked Intersection	No	No
Lane Alignment	Left	Right
Median Width(ft)	12	
Link Offset(ft)	0	
Crosswalk Width(ft)	16	
Two way Left Turn Lane		
Headway Factor	1.00	1.00
Turning Speed (mph)		9
Number of Detectors	1	
Detector Template		
Leading Detector (ft)	50	
Trailing Detector (ft)	0	
Detector 1 Position(ft)	0	
Detector 1 Size(ft)	50	
Detector 1 Type	CI+Ex	
Detector 1 Channel		
Detector 1 Extend (s)	0.0	
Detector 1 Queue (s)	0.0	
Detector 1 Delay (s)	0.0	
Turn Type	NA	
Protected Phases	2	
Permitted Phases		
Detector Phase	2	
Switch Phase		
Minimum Initial (s)	20.0	
Minimum Split (s)	26.0	
Total Split (s)	93.0	

09/26/2022 4:54 pm  
Kimley-Horn

Synchro 11 Report  
Page 21

Pepper Square TIA  
Lanes, Volumes, Timings

Phase 1 & P - 2028 Background + Site - PM  
1369: Preston & Belt Line Village Driveway

Lane Group	EBL	EBT	EBR	WBL	WBT	WBR	NBU	NBL	NBT	NBR	SBU	SBL
Total Split (%)	29.4%	29.4%		29.4%	29.4%		12.5%	12.5%	61.3%		9.4%	9.4%
Maximum Green (s)	42.3	42.3		42.3	42.3		15.0	15.0	93.7		10.0	10.0
Yellow Time (s)	3.0	3.0		3.0	3.0		3.0	3.0	3.0		3.0	3.0
All-Red Time (s)	1.7	1.7		1.7	1.7		2.0	2.0	1.3		2.0	2.0
Lost Time Adjust (s)		-1.0		-1.0	-1.0			-1.0	-2.0			-1.0
Total Lost Time (s)		3.7		3.7	3.7			4.0	2.3			4.0
Lead/Lag							Lead	Lead	Lead		Lag	Lag
Lead-Lag Optimize?							Yes	Yes	Yes		Yes	Yes
Vehicle Extension (s)	2.0	2.0		2.0	2.0		1.5	1.5	3.0		1.5	1.5
Recall Mode	None	None		None	None		None	None	Max		None	None
Walk Time (s)	5.0	5.0		5.0	5.0				7.0			
Flash Dont Walk (s)	15.0	15.0		15.0	15.0				8.0			
Pedestrian Calls (#/hr)	0	0		0	0				0			
Act Effect Green (s)		21.9		21.9	21.9			126.4	117.1			126.4
Actuated g/C Ratio		0.14		0.14	0.14			0.79	0.73			0.79
v/c Ratio		0.36		0.61	0.22			0.37	0.65			0.82
Control Delay		40.2		82.3	18.8			13.1	2.3			65.1
Queue Delay		0.0		0.0	0.0			0.0	0.3			0.0
Total Delay		40.2		82.3	18.8			13.1	2.5			65.1
LOS		D		F	B			B	A			E
Approach Delay		40.2			57.3				2.8			
Approach LOS		D			E				A			
Queue Length 50th (ft)		43		92	6			3	49			98
Queue Length 95th (ft)		78		154	50			m11	53			m#145
Internal Link Dist (ft)		223			169				172			
Turn Bay Length (ft)								100				100
Base Capacity (vph)		723		297	474			279	3710			176
Starvation Cap Reductn		0		0	0			0	541			0
Spillback Cap Reductn		2		0	4			0	417			0
Storage Cap Reductn		0		0	0			0	0			0
Reduced v/c Ratio		0.20		0.31	0.13			0.25	0.76			0.82

Intersection Summary

Area Type: Other  
 Cycle Length: 160  
 Actuated Cycle Length: 160  
 Offset: 86 (54%), Referenced to phase 2:NBSB, Start of Yellow  
 Natural Cycle: 70  
 Control Type: Actuated-Coordinated  
 Maximum v/c Ratio: 0.82  
 Intersection Signal Delay: 7.6  
 Intersection LOS: A  
 Intersection Capacity Utilization 79.5%  
 ICU Level of Service D  
 Analysis Period (min) 15  
 # 95th percentile volume exceeds capacity, queue may be longer.  
 Queue shown is maximum after two cycles.  
 m Volume for 95th percentile queue is metered by upstream signal.

Splits and Phases: 1369: Preston & Belt Line Village Driveway

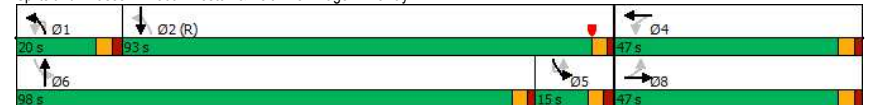

Pepper Square TIA  
Lanes, Volumes, Timings

Phase 1 & P - 2028 Background + Site - PM  
1369: Preston & Belt Line Village Driveway

Lane Group	SBT	SBR
Total Split (%)	58.1%	
Maximum Green (s)	88.7	
Yellow Time (s)	3.0	
All-Red Time (s)	1.3	
Lost Time Adjust (s)	-2.0	
Total Lost Time (s)	2.3	
Lead/Lag	Lag	
Lead-Lag Optimize?	Yes	
Vehicle Extension (s)	3.3	
Recall Mode	C-Max	
Walk Time (s)	7.0	
Flash Dont Walk (s)	8.0	
Pedestrian Calls (#/hr)	0	
Act Effect Green (s)	120.4	
Actuated g/C Ratio	0.75	
v/c Ratio	0.52	
Control Delay	3.0	
Queue Delay	0.3	
Total Delay	3.3	
LOS	A	
Approach Delay	7.5	
Approach LOS	A	
Queue Length 50th (ft)	58	
Queue Length 95th (ft)	m141	
Internal Link Dist (ft)	111	
Turn Bay Length (ft)		
Base Capacity (vph)	3819	
Starvation Cap Reductn	1055	
Spillback Cap Reductn	0	
Storage Cap Reductn	0	
Reduced v/c Ratio	0.72	
<b>Intersection Summary</b>		

Pepper Square TIA  
Lanes, Volumes, Timings

Phase 1 & P - 2028 Background + Site - PM  
1371: Preston & Spring Valley

Lane Group	EBL	EBT	EBR	WBL	WBT	WBR	NBU	NBL	NBT	NBR	SBU	SBL
Lane Configurations	↑↑	↑↑↑		↑↑	↑↑↑			↑↑	↑↑↑			↑↑
Traffic Volume (vph)	328	787	225	104	484	172	1	191	2267	198	6	166
Future Volume (vph)	328	787	225	104	484	172	1	191	2267	198	6	166
Ideal Flow (vphpl)	1900	1900	1900	1900	1900	1900	1900	1900	1900	1900	1900	1900
Storage Length (ft)	225		0	225		0		225		0		275
Storage Lanes	2		0	2		0		2		0		2
Taper Length (ft)	25			25				25				25
Lane Util. Factor	0.97	0.91	0.91	0.97	0.91	0.91	0.91	0.97	0.91	0.91	0.91	0.97
Fr		0.967			0.961				0.988			
Fit Protected	0.950			0.950				0.950				0.950
Satd. Flow (prot)	3433	4917	0	3433	4887	0	0	3433	5024	0	0	3433
Fit Permitted	0.950			0.950				0.950				0.950
Satd. Flow (perm)	3433	4917	0	3433	4887	0	0	3433	5024	0	0	3433
Right Turn on Red			Yes			Yes				Yes		
Satd. Flow (RTOR)		45			45				12			
Link Speed (mph)		38			42				41			
Link Distance (ft)		3259			5488				2139			
Travel Time (s)		58.5			89.1				35.6			
Peak Hour Factor	0.94	0.94	0.94	0.94	0.94	0.94	0.94	0.94	0.94	0.94	0.94	0.94
Adj. Flow (vph)	349	837	239	111	515	183	1	203	2412	211	6	177
Shared Lane Traffic (%)												
Lane Group Flow (vph)	349	1076	0	111	698	0	0	204	2623	0	0	183
Enter Blocked Intersection	No	No	No	No	No	No	No	No	No	No	No	No
Lane Alignment	Left	Left	Right	Left	Left	Right	R NA	Left	Left	Right	R NA	Left
Median Width(ft)		24			24				24			
Link Offset(ft)		0			0				0			
Crosswalk Width(ft)		16			16				16			
Two way Left Turn Lane												
Headway Factor	1.00	1.00	1.00	1.00	1.00	1.00	1.00	1.00	1.00	1.00	1.00	1.00
Turning Speed (mph)	15		9	15		9	9	15		9	9	15
Number of Detectors	1	1		1	1		1	1	1	1	1	1
Detector Template												
Leading Detector (ft)	50	50		50	50		50	50	50		50	50
Trailing Detector (ft)	0	0		0	0		0	0	0		0	0
Detector 1 Position(ft)	0	0		0	0		0	0	0		0	0
Detector 1 Size(ft)	50	50		50	50		50	50	50		50	50
Detector 1 Type	CI+Ex	CI+Ex		CI+Ex	CI+Ex		CI+Ex	CI+Ex	CI+Ex		CI+Ex	CI+Ex
Detector 1 Channel												
Detector 1 Extend (s)	0.0	0.0		0.0	0.0		0.0	0.0	0.0		0.0	0.0
Detector 1 Queue (s)	0.0	0.0		0.0	0.0		0.0	0.0	0.0		0.0	0.0
Detector 1 Delay (s)	0.0	0.0		0.0	0.0		0.0	0.0	0.0		0.0	0.0
Turn Type	Prot	NA		Prot	NA		Prot	Prot	NA		Prot	Prot
Protected Phases	3	8		7	4		1	1	6		5	5
Permitted Phases												
Detector Phase	3	8		7	4		1	1	6		5	5
Switch Phase												
Minimum Initial (s)	6.0	12.0		3.0	12.0		3.0	3.0	13.0		3.0	3.0
Minimum Split (s)	11.0	27.5		11.0	27.5		11.0	11.0	28.0		11.0	11.0
Total Split (s)	40.0	50.0		13.0	23.0		22.0	22.0	82.0		15.0	15.0

Pepper Square TIA  
Lanes, Volumes, Timings

Phase 1 & P - 2028 Background + Site - PM  
1371: Preston & Spring Valley

Lane Group	SBT	SBR
Lane Configurations	↑↑↓	
Traffic Volume (vph)	1612	207
Future Volume (vph)	1612	207
Ideal Flow (vphpl)	1900	1900
Storage Length (ft)	0	
Storage Lanes	0	
Taper Length (ft)		
Lane Util. Factor	0.91	0.91
Fr't	0.983	
Fit Protected		
Satd. Flow (prot)	4999	0
Fit Permitted		
Satd. Flow (perm)	4999	0
Right Turn on Red		Yes
Satd. Flow (RTOR)	18	
Link Speed (mph)	38	
Link Distance (ft)	1208	
Travel Time (s)	21.7	
Peak Hour Factor	0.94	0.94
Adj. Flow (vph)	1715	220
Shared Lane Traffic (%)		
Lane Group Flow (vph)	1935	0
Enter Blocked Intersection	No	No
Lane Alignment	Left	Right
Median Width(ft)	24	
Link Offset(ft)	0	
Crosswalk Width(ft)	16	
Two way Left Turn Lane		
Headway Factor	1.00	1.00
Turning Speed (mph)		9
Number of Detectors	1	
Detector Template		
Leading Detector (ft)	50	
Trailing Detector (ft)	0	
Detector 1 Position(ft)	0	
Detector 1 Size(ft)	50	
Detector 1 Type	CI+Ex	
Detector 1 Channel		
Detector 1 Extend (s)	0.0	
Detector 1 Queue (s)	0.0	
Detector 1 Delay (s)	0.0	
Turn Type	NA	
Protected Phases	2	
Permitted Phases		
Detector Phase	2	
Switch Phase		
Minimum Initial (s)	18.0	
Minimum Split (s)	28.0	
Total Split (s)	75.0	

Pepper Square TIA  
Lanes, Volumes, Timings

Phase 1 & P - 2028 Background + Site - PM  
1371: Preston & Spring Valley

Lane Group	EBL	EBT	EBR	WBL	WBT	WBR	NBU	NBL	NBT	NBR	SBU	SBL
Total Split (%)	25.0%	31.3%		8.1%	14.4%		13.8%	13.8%	51.3%		9.4%	9.4%
Maximum Green (s)	35.0	44.5		8.0	17.5		17.0	17.0	76.0		10.0	10.0
Yellow Time (s)	3.0	4.0		3.0	4.0		3.0	3.0	4.5		3.0	3.0
All-Red Time (s)	2.0	1.5		2.0	1.5		2.0	2.0	1.5		2.0	2.0
Lost Time Adjust (s)	-1.0	-1.5		-1.0	-1.5			-1.0	-2.0			-1.0
Total Lost Time (s)	4.0	4.0		4.0	4.0			4.0	4.0			4.0
Lead/Lag	Lead	Lead		Lag	Lag		Lead	Lead	Lead		Lag	Lag
Lead-Lag Optimize?	Yes	Yes		Yes	Yes		Yes	Yes	Yes		Yes	Yes
Vehicle Extension (s)	0.8	2.0		0.8	2.0		0.8	0.8	2.5		0.8	0.8
Recall Mode	None	Max		None	Max		None	None	None		None	None
Walk Time (s)		4.0			4.0				4.0			
Flash Dont Walk (s)		18.0			18.0				18.0			
Pedestrian Calls (#/hr)		0			0				0			
Act Effect Green (s)	20.6	46.0		9.0	34.4			13.7	78.0			11.0
Actuated g/C Ratio	0.13	0.29		0.06	0.22			0.09	0.49			0.07
v/c Ratio	0.79	0.74		0.58	0.64			0.69	1.07			0.78
Control Delay	75.7	51.6		70.7	50.4			82.8	80.3			75.9
Queue Delay	0.0	0.0		0.0	0.0			0.0	0.0			0.0
Total Delay	75.7	51.6		70.7	50.4			82.8	80.3			75.9
LOS	E	D		E	D			F	F			E
Approach Delay		57.5			53.1				80.5			
Approach LOS		E			D				F			
Queue Length 50th (ft)	182	378		60	234			112	~1076			98
Queue Length 95th (ft)	235	422		m57	m241			m155	#1160			m#140
Internal Link Dist (ft)		3179			5408				2059			
Turn Bay Length (ft)	225			225				225				275
Base Capacity (vph)	772	1445		193	1085			386	2455			236
Starvation Cap Reductn	0	0		0	0			0	0			0
Spillback Cap Reductn	0	0		0	0			0	0			0
Storage Cap Reductn	0	0		0	0			0	0			0
Reduced v/c Ratio	0.45	0.74		0.58	0.64			0.53	1.07			0.78

Intersection Summary

Area Type:	Other
Cycle Length:	160
Actuated Cycle Length:	160
Offset:	135 (84%), Referenced to phase 2:SBT, Start of Yellow
Natural Cycle:	120
Control Type:	Actuated-Coordinated
Maximum v/c Ratio:	1.07
Intersection Signal Delay:	58.2
Intersection LOS:	E
Intersection Capacity Utilization:	90.0%
ICU Level of Service:	E
Analysis Period (min):	15
~	Volume exceeds capacity, queue is theoretically infinite. Queue shown is maximum after two cycles.
#	95th percentile volume exceeds capacity, queue may be longer. Queue shown is maximum after two cycles.
m	Volume for 95th percentile queue is metered by upstream signal.

Pepper Square TIA  
Lanes, Volumes, Timings

Phase 1 & P - 2028 Background + Site - PM  
1371: Preston & Spring Valley

Splits and Phases: 1371: Preston & Spring Valley

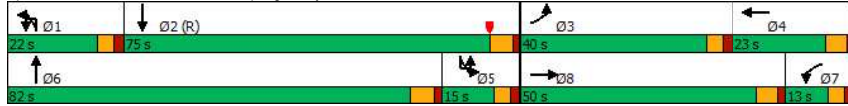

Pepper Square TIA  
Lanes, Volumes, Timings

Phase 1 & P - 2028 Background + Site - PM  
1371: Preston & Spring Valley

Lane Group	SBT	SBR
Total Split (%)	46.9%	
Maximum Green (s)	69.0	
Yellow Time (s)	4.5	
All-Red Time (s)	1.5	
Lost Time Adjust (s)	-2.0	
Total Lost Time (s)	4.0	
Lead/Lag	Lag	
Lead-Lag Optimize?	Yes	
Vehicle Extension (s)	2.4	
Recall Mode	C-Max	
Walk Time (s)	4.0	
Flash Dont Walk (s)	18.0	
Pedestrian Calls (#/hr)	0	
Act Effect Green (s)	75.3	
Actuated g/C Ratio	0.47	
v/c Ratio	0.82	
Control Delay	26.8	
Queue Delay	0.0	
Total Delay	26.8	
LOS	C	
Approach Delay	31.0	
Approach LOS	C	
Queue Length 50th (ft)	280	
Queue Length 95th (ft)	597	
Internal Link Dist (ft)	1128	
Turn Bay Length (ft)		
Base Capacity (vph)	2360	
Starvation Cap Reductn	0	
Spillback Cap Reductn	0	
Storage Cap Reductn	0	
Reduced v/c Ratio	0.82	
Intersection Summary		

Pepper Square TIA  
Lanes, Volumes, Timings

Phase 1 & P - 2028 Background + Site - PM  
1405: Prestonwood & Belt Line

Lane Group	EBU	EBL	EBT	EBR	WBU	WBL	WBT	WBR	NBL	NBT	NBR	SBL
Lane Configurations			↑↑↑				↑↑↑					↑↑
Traffic Volume (vph)	7	80	1687	7	3	2	1357	106	6	1	2	151
Future Volume (vph)	7	80	1687	7	3	2	1357	106	6	1	2	151
Ideal Flow (vphpl)	1900	1900	1900	1900	1900	1900	1900	1900	1900	1900	1900	1900
Storage Length (ft)		200		0		200		0	0		0	300
Storage Lanes		1		0		1		0	0		0	2
Taper Length (ft)		25				25			25			25
Lane Util. Factor	0.91	1.00	0.91	0.91	0.91	1.00	0.91	0.91	1.00	1.00	1.00	0.97
Fr			0.999				0.989			0.970		
Fit Protected		0.950				0.950				0.968		0.950
Satd. Flow (prot)	0	1770	5080	0	0	1770	5029	0	0	1749	0	3433
Fit Permitted		0.070				0.105				0.968		0.950
Satd. Flow (perm)	0	130	5080	0	0	196	5029	0	0	1749	0	3433
Right Turn on Red			Yes				Yes			Yes		
Satd. Flow (RTOR)			1				12			2		
Link Speed (mph)			42				42			30		
Link Distance (ft)			1445				2036			315		
Travel Time (s)			23.5				33.1			7.2		
Peak Hour Factor	0.95	0.95	0.95	0.95	0.95	0.95	0.95	0.95	0.95	0.95	0.95	0.95
Adj. Flow (vph)	7	84	1776	7	3	2	1428	112	6	1	2	159
Shared Lane Traffic (%)												
Lane Group Flow (vph)	0	91	1783	0	0	5	1540	0	0	9	0	159
Enter Blocked Intersection	No	No	No	No	No	No	No	No	No	No	No	No
Lane Alignment	R NA	Left	Left	Right	R NA	Left	Right	Left	Left	Right	Right	Left
Median Width(ft)			24				24			24		
Link Offset(ft)			0				0			0		
Crosswalk Width(ft)			16				16			16		
Two way Left Turn Lane												
Headway Factor	1.00	1.00	1.00	1.00	1.00	1.00	1.00	1.00	1.00	1.00	1.00	1.00
Turning Speed (mph)	9	15		9	9	15		9	15		9	15
Number of Detectors	1	1	1		1	1	1		1	1		1
Detector Template												
Leading Detector (ft)	50	50	50		50	50	50		50	50		50
Trailing Detector (ft)	0	0	0		0	0	0		0	0		0
Detector 1 Position(ft)	0	0	0		0	0	0		0	0		0
Detector 1 Size(ft)	50	50	50		50	50	50		50	50		50
Detector 1 Type	CI+Ex	CI+Ex	CI+Ex		CI+Ex	CI+Ex	CI+Ex		CI+Ex	CI+Ex		CI+Ex
Detector 1 Channel												
Detector 1 Extend (s)	0.0	0.0	0.0		0.0	0.0	0.0		0.0	0.0		0.0
Detector 1 Queue (s)	0.0	0.0	0.0		0.0	0.0	0.0		0.0	0.0		0.0
Detector 1 Delay (s)	0.0	0.0	0.0		0.0	0.0	0.0		0.0	0.0		0.0
Turn Type	D,P+P	D,P+P	NA		D,P+P	D,P+P	NA		Split	NA		Split
Protected Phases	1	1	6		5	5	2		3	3		4
Permitted Phases	2	2			6	6						
Detector Phase	1	1	6		5	5	2		3	3		4
Switch Phase												
Minimum Initial (s)	3.0	3.0	15.0		3.0	3.0	15.0		5.0	5.0		7.0
Minimum Split (s)	8.0	8.0	22.0		8.0	8.0	24.0		23.0	23.0		23.2
Total Split (s)	25.0	25.0	99.0		15.0	15.0	89.0		18.0	18.0		28.0

Pepper Square TIA  
Lanes, Volumes, Timings

Phase 1 & P - 2028 Background + Site - PM  
1405: Prestonwood & Belt Line

Lane Group	SBT	SBR
Lane Configurations	↑	↑
Traffic Volume (vph)	2	83
Future Volume (vph)	2	83
Ideal Flow (vphpl)	1900	1900
Storage Length (ft)		0
Storage Lanes		1
Taper Length (ft)		
Lane Util. Factor	0.95	0.95
Fr	0.857	0.850
Fit Protected		
Satd. Flow (prot)	1517	1504
Fit Permitted		
Satd. Flow (perm)	1517	1504
Right Turn on Red		Yes
Satd. Flow (RTOR)	43	89
Link Speed (mph)		30
Link Distance (ft)		868
Travel Time (s)		19.7
Peak Hour Factor	0.95	0.95
Adj. Flow (vph)	2	87
Shared Lane Traffic (%)		49%
Lane Group Flow (vph)	45	44
Enter Blocked Intersection	No	No
Lane Alignment	Left	Right
Median Width(ft)		24
Link Offset(ft)		0
Crosswalk Width(ft)		16
Two way Left Turn Lane		
Headway Factor	1.00	1.00
Turning Speed (mph)		9
Number of Detectors	1	1
Detector Template		
Leading Detector (ft)	50	50
Trailing Detector (ft)	0	0
Detector 1 Position(ft)	0	0
Detector 1 Size(ft)	50	50
Detector 1 Type	CI+Ex	CI+Ex
Detector 1 Channel		
Detector 1 Extend (s)	0.0	0.0
Detector 1 Queue (s)	0.0	0.0
Detector 1 Delay (s)	0.0	0.0
Turn Type	NA	custom
Protected Phases	4	
Permitted Phases		1 4
Detector Phase	4	1 4
Switch Phase		
Minimum Initial (s)		7.0
Minimum Split (s)		23.2
Total Split (s)		28.0



Pepper Square TIA  
Lanes, Volumes, Timings

Phase 1 & P - 2028 Background + Site - PM  
1405: Prestonwood & Belt Line



Lane Group	EBU	EBL	EBT	EBR	WBU	WBL	WBT	WBR	NBL	NBT	NBR	SBL
Total Split (%)	15.6%	15.6%	61.9%		9.4%	9.4%	55.6%		11.3%	11.3%		17.5%
Maximum Green (s)	20.0	20.0	93.0		10.0	10.0	83.0		13.0	13.0		22.8
Yellow Time (s)	3.0	3.0	4.5		3.0	3.0	4.5		3.0	3.0		3.2
All-Red Time (s)	2.0	2.0	1.5		2.0	2.0	1.5		2.0	2.0		2.0
Lost Time Adjust (s)		-1.0	-2.0			-1.0	-2.0			-1.0		-1.2
Total Lost Time (s)		4.0	4.0			4.0	4.0			4.0		4.0
Lead/Lag	Lag	Lag	Lag		Lead	Lead	Lead		Lead	Lead		Lag
Lead-Lag Optimize?	Yes	Yes	Yes		Yes	Yes	Yes		Yes	Yes		Yes
Vehicle Extension (s)	1.0	1.0	2.5		1.0	1.0	2.5		1.5	1.5		1.5
Recall Mode	None	None	C-Max		None	None	None		None	None		None
Walk Time (s)			5.0				4.0		4.0	4.0		4.0
Flash Dont Walk (s)			10.0				14.0		14.0	14.0		14.0
Pedestrian Calls (#/hr)			0				0		0	0		0
Act Effect Green (s)		131.2	133.4			134.4	76.0			6.3		12.5
Actuated g/C Ratio		0.82	0.83			0.84	0.48			0.04		0.08
v/c Ratio		0.14	0.42			0.02	0.64			0.13		0.59
Control Delay		18.3	4.9			0.8	20.9			67.0		80.1
Queue Delay		0.0	0.0			0.0	0.0			0.0		0.0
Total Delay		18.3	4.9			0.8	20.9			67.0		80.1
LOS		B	A			A	C			E		F
Approach Delay			5.6				20.8			67.0		
Approach LOS			A				C			E		
Queue Length 50th (ft)		11	49			0	204			7		84
Queue Length 95th (ft)		61	418			m1	m310			28		122
Internal Link Dist (ft)			1365				1956			235		
Turn Bay Length (ft)		200				200						300
Base Capacity (vph)		672	4236			273	2677			154		514
Starvation Cap Reductn		0	0			0	0			0		0
Spillback Cap Reductn		0	0			0	0			0		0
Storage Cap Reductn		0	0			0	0			0		0
Reduced v/c Ratio		0.14	0.42			0.02	0.58			0.06		0.31

Intersection Summary

Area Type: Other  
 Cycle Length: 160  
 Actuated Cycle Length: 160  
 Offset: 60 (38%), Referenced to phase 6:EBWB, Start of Yellow  
 Natural Cycle: 90  
 Control Type: Actuated-Coordinated  
 Maximum v/c Ratio: 0.64  
 Intersection Signal Delay: 15.5 Intersection LOS: B  
 Intersection Capacity Utilization 54.3% ICU Level of Service A  
 Analysis Period (min) 15  
 m Volume for 95th percentile queue is metered by upstream signal.

Splits and Phases: 1405: Prestonwood & Belt Line

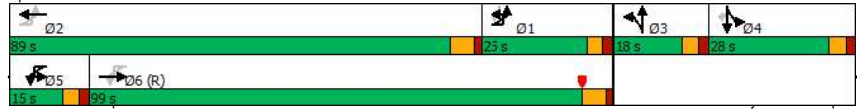

Pepper Square TIA  
Lanes, Volumes, Timings

Phase 1 & P - 2028 Background + Site - PM  
1405: Prestonwood & Belt Line



Lane Group	SBT	SBR
Total Split (%)	17.5%	
Maximum Green (s)	22.8	
Yellow Time (s)	3.2	
All-Red Time (s)	2.0	
Lost Time Adjust (s)	-1.2	
Total Lost Time (s)	4.0	
Lead/Lag	Lag	
Lead-Lag Optimize?	Yes	
Vehicle Extension (s)	1.5	
Recall Mode	None	
Walk Time (s)	4.0	
Flash Dont Walk (s)	14.0	
Pedestrian Calls (#/hr)	0	
Act Effect Green (s)	12.5	70.1
Actuated g/C Ratio	0.08	0.44
v/c Ratio	0.28	0.06
Control Delay	23.5	0.2
Queue Delay	0.0	0.0
Total Delay	23.5	0.2
LOS	C	A
Approach Delay	55.7	
Approach LOS	E	
Queue Length 50th (ft)	2	0
Queue Length 95th (ft)	45	0
Internal Link Dist (ft)	788	
Turn Bay Length (ft)		
Base Capacity (vph)	264	810
Starvation Cap Reductn	0	0
Spillback Cap Reductn	0	0
Storage Cap Reductn	0	0
Reduced v/c Ratio	0.17	0.05

Intersection Summary

Area Type: Other  
 Cycle Length: 160  
 Actuated Cycle Length: 160  
 Offset: 60 (38%), Referenced to phase 6:EBWB, Start of Yellow  
 Natural Cycle: 90  
 Control Type: Actuated-Coordinated  
 Maximum v/c Ratio: 0.64  
 Intersection Signal Delay: 15.5 Intersection LOS: B  
 Intersection Capacity Utilization 54.3% ICU Level of Service A  
 Analysis Period (min) 15  
 m Volume for 95th percentile queue is metered by upstream signal.

Pepper Square TIA  
HCM 6th TWSC

Phase 1 & P - 2028 Background + Site - PM  
2: Ladera Drive & Belt Line

Intersection												
Int Delay, s/veh	2.4											
Movement	EBL	EBT	EBR	WBL	WBT	WBR	NBL	NBT	NBR	SBL	SBT	SBR
Lane Configurations	↔ ↑↑↔			↔ ↑↑↔			↔ ↑↑↔			↔ ↑↑↔		
Traffic Vol, veh/h	132	1706	57	77	1340	80	17	1	49	38	1	83
Future Vol, veh/h	132	1706	57	77	1340	80	17	1	49	38	1	83
Conflicting Peds, #/hr	0	0	0	0	0	0	0	0	0	0	0	0
Sign Control	Free	Free	Free	Free	Free	Stop	Stop	Stop	Stop	Stop	Stop	Stop
RT Channelized	-	-	None	-	-	None	-	-	None	-	-	None
Storage Length	100	-	-	100	-	-	-	-	0	-	-	0
Veh in Median Storage, #	-	0	-	-	0	-	-	1	-	-	1	-
Grade, %	-	0	-	-	0	-	-	0	-	-	0	-
Peak Hour Factor	96	96	96	96	96	96	96	96	96	96	96	96
Heavy Vehicles, %	2	2	2	2	2	2	2	2	2	2	2	2
Mvmt Flow	138	1777	59	80	1396	83	18	1	51	40	1	86

Major/Minor	Major1	Major2	Minor1	Minor2
Conflicting Flow All	1479	0	0	1836
Stage 1	-	-	-	-
Stage 2	-	-	-	-
Critical Hdwy	5.34	-	-	5.34
Critical Hdwy Stg 1	-	-	-	-
Critical Hdwy Stg 2	-	-	-	-
Follow-up Hdwy	3.12	-	-	3.12
Pot Cap-1 Maneuver	228	-	-	*660
Stage 1	-	-	-	-
Stage 2	-	-	-	-
Platoon blocked, %	-	-	-	-
Mov Cap-1 Maneuver	228	-	-	*660
Mov Cap-2 Maneuver	-	-	-	-
Stage 1	-	-	-	-
Stage 2	-	-	-	-

Approach	EB	WB	NB	SB
HCM Control Delay, s	2.9	0.6	35.1	-
HCM LOS	E		-	

Minor Lane/Major Mvmt	NBLn1	NBLn2	EBL	EBT	EBR	WBL	WBT	WBR	SBLn1	SBLn2
Capacity (veh/h)	57	525	228	-	-	*660	-	-	-	308
HCM Lane V/C Ratio	0.329	0.097	0.603	-	-	0.122	-	-	-	0.281
HCM Control Delay (s)	96.5	12.6	42.2	-	-	11.2	-	-	-	21.2
HCM Lane LOS	F	B	E	-	-	B	-	-	-	C
HCM 95th %tile Q(veh)	1.2	0.3	3.5	-	-	0.4	-	-	-	1.1

Notes  
 ~: Volume exceeds capacity    \$: Delay exceeds 300s    +: Computation Not Defined    \*: All major volume in platoon

Pepper Square TIA  
HCM 6th TWSC

Phase 1 & P - 2028 Background + Site - PM  
3: Median Opening East of Preston Rd & Belt Line

Intersection												
Int Delay, s/veh	0.5											
Movement	EBU	EBL	EBT	EBR	WBU	WBL	WBT	WBR	NBL	NBT	NBR	SBL
Lane Configurations	↔ ↑↑↔			↔ ↑↑↔			↔ ↑↑↔			↔ ↑↑↔		
Traffic Vol, veh/h	6	6	1247	12	1	13	947	5	2	0	2	21
Future Vol, veh/h	6	6	1247	12	1	13	947	5	2	0	2	21
Conflicting Peds, #/hr	0	0	0	0	0	0	0	0	0	0	0	0
Sign Control	Free	Free	Free	Free	Free	Free	Free	Free	Stop	Stop	Stop	Stop
RT Channelized	-	-	-	None	-	-	-	None	-	-	None	-
Storage Length	-	150	-	-	-	200	-	-	-	-	-	-
Veh in Median Storage, #	-	-	0	-	-	0	-	-	1	-	-	1
Grade, %	-	-	0	-	-	0	-	-	0	-	-	0
Peak Hour Factor	93	93	93	93	93	93	93	93	93	93	93	93
Heavy Vehicles, %	2	2	2	2	2	2	2	2	2	2	2	2
Mvmt Flow	6	6	1341	13	1	14	1018	5	2	0	2	23

Major/Minor	Major1	Major2	Minor1	Minor2
Conflicting Flow All	747	1023	0	0
Stage 1	-	-	-	-
Stage 2	-	-	-	-
Critical Hdwy	5.64	5.34	-	-
Critical Hdwy Stg 1	-	-	-	-
Critical Hdwy Stg 2	-	-	-	-
Follow-up Hdwy	2.32	3.12	-	-
Pot Cap-1 Maneuver	*1189	*884	-	-
Stage 1	-	-	-	-
Stage 2	-	-	-	-
Platoon blocked, %	1	1	-	-
Mov Cap-1 Maneuver	*1000	*1000	-	-
Mov Cap-2 Maneuver	-	-	-	-
Stage 1	-	-	-	-
Stage 2	-	-	-	-

Approach	EB	WB	NB	SB
HCM Control Delay, s	0.1	0.3	31.9	14.1
HCM LOS	D		B	

Minor Lane/Major Mvmt	NBLn1	EBL	EBT	EBR	WBL	WBT	WBR	SBLn1
Capacity (veh/h)	138	*1000	-	-	271	-	-	445
HCM Lane V/C Ratio	0.031	0.013	-	-	0.056	-	-	0.106
HCM Control Delay (s)	31.9	8.6	-	-	19.1	-	-	14.1
HCM Lane LOS	D	A	-	-	C	-	-	B
HCM 95th %tile Q(veh)	0.1	0	-	-	0.2	-	-	0.4

Notes  
 ~: Volume exceeds capacity    \$: Delay exceeds 300s    +: Computation Not Defined    \*: All major volume in platoon

Pepper Square TIA  
HCM 6th TWSC

Phase 1 & P - 2028 Background + Site - PM  
5: Belt Line & Median between Berry Trail and Alexis Dr

Intersection												
Int Delay, s/veh	0.7											
Movement	EBL	EBT	EBR	WBL	WBT	WBR	NBL	NBT	NBR	SBL	SBT	SBR
Lane Configurations	↔ ↑↑↑			↔ ↑↑↑			↔			↔		
Traffic Vol, veh/h	8	1282	34	48	944	12	14	4	53	4	1	7
Future Vol, veh/h	8	1282	34	48	944	12	14	4	53	4	1	7
Conflicting Peds, #/hr	0	0	0	0	0	0	0	0	0	0	0	0
Sign Control	Free	Free	Free	Free	Free	Stop	Stop	Stop	Stop	Stop	Stop	Stop
RT Channelized	-	-	None	-	-	None	-	-	None	-	-	None
Storage Length	150	-	-	150	-	-	-	-	-	-	-	-
Veh in Median Storage, #	-	0	-	-	0	-	-	1	-	-	1	-
Grade, %	-	0	-	-	0	-	-	0	-	-	0	-
Peak Hour Factor	94	94	94	94	94	94	94	94	94	94	94	94
Heavy Vehicles, %	2	2	2	2	2	2	2	2	2	2	2	2
Mvmt Flow	9	1364	36	51	1004	13	15	4	56	4	1	7

Major/Minor	Major1	Major2	Minor1	Minor2
Conflicting Flow All	1017	0	0	1400
Stage 1	-	-	-	-
Stage 2	-	-	-	-
Critical Hdwy	5.34	-	-	5.34
Critical Hdwy Stg 1	-	-	-	-
Critical Hdwy Stg 2	-	-	-	-
Follow-up Hdwy	3.12	-	-	3.12
Pot Cap-1 Maneuver	*884	-	-	*782
Stage 1	-	-	-	-
Stage 2	-	-	-	-
Platoon blocked, %	1	-	-	1
Mov Cap-1 Maneuver	*884	-	-	*782
Mov Cap-2 Maneuver	-	-	-	-
Stage 1	-	-	-	-
Stage 2	-	-	-	-

Approach	EB	WB	NB	SB
HCM Control Delay, s	0.1	0.5	12.3	11.7
HCM LOS			B	B

Minor Lane/Major Mvmt	NBLn1	EBL	EBT	EBR	WBL	WBT	WBR	SBLn1
Capacity (veh/h)	570	*884	-	-	*782	-	-	547
HCM Lane V/C Ratio	0.133	0.01	-	-	0.065	-	-	0.023
HCM Control Delay (s)	12.3	9.1	-	-	9.9	-	-	11.7
HCM Lane LOS	B	A	-	-	A	-	-	B
HCM 95th %tile Q(veh)	0.5	0	-	-	0.2	-	-	0.1

Notes  
 ~: Volume exceeds capacity    \$: Delay exceeds 300s    +: Computation Not Defined    \*: All major volume in platoon

Pepper Square TIA  
HCM 6th TWSC

Phase 1 & P - 2028 Background + Site - PM  
6: Alexis Drive & Belt Line

Intersection						
Int Delay, s/veh	2.9					
Movement	EBT	EBR	WBL	WBT	NBL	NBR
Lane Configurations	↑↑↑		↔ ↑↑↑		↔	
Traffic Vol, veh/h	1306	19	244	993	4	313
Future Vol, veh/h	1306	19	244	993	4	313
Conflicting Peds, #/hr	0	0	0	0	0	0
Sign Control	Free	Free	Free	Free	Stop	Stop
RT Channelized	-	None	-	None	-	Yield
Storage Length	-	-	150	-	0	0
Veh in Median Storage, #	0	-	-	0	1	-
Grade, %	0	-	-	0	0	-
Peak Hour Factor	95	95	95	95	95	95
Heavy Vehicles, %	2	2	2	2	2	2
Mvmt Flow	1375	20	257	1045	4	329

Major/Minor	Major1	Major2	Minor1
Conflicting Flow All	0	0	1395
Stage 1	-	-	-
Stage 2	-	-	-
Critical Hdwy	-	-	5.34
Critical Hdwy Stg 1	-	-	-
Critical Hdwy Stg 2	-	-	-
Follow-up Hdwy	-	-	3.12
Pot Cap-1 Maneuver	-	-	*782
Stage 1	-	-	-
Stage 2	-	-	-
Platoon blocked, %	-	-	1
Mov Cap-1 Maneuver	-	-	*782
Mov Cap-2 Maneuver	-	-	-
Stage 1	-	-	-
Stage 2	-	-	-

Approach	EB	WB	NB
HCM Control Delay, s	0	2.3	17.1
HCM LOS			C

Minor Lane/Major Mvmt	NBLn1	NBLn2	EBT	EBR	WBL	WBT
Capacity (veh/h)	375	622	-	-	*782	-
HCM Lane V/C Ratio	0.011	0.53	-	-	0.328	-
HCM Control Delay (s)	14.7	17.1	-	-	11.8	-
HCM Lane LOS	B	C	-	-	B	-
HCM 95th %tile Q(veh)	0	3.1	-	-	1.4	-

Notes  
 ~: Volume exceeds capacity    \$: Delay exceeds 300s    +: Computation Not Defined    \*: All major volume in platoon

Pepper Square TIA  
HCM 6th TWSC

Phase 1 & P - 2028 Background + Site - PM  
10: Preston & Pepper Square Driveway

Intersection													
Int Delay, s/veh	9.6												
Movement	EBL	EBT	EBR	WBL	WBT	WBR	NBL	NBT	NBR	SBL	SBT	SBR	
Lane Configurations		↔			↔	↔		↔	↔	↔	↔	↔	
Traffic Vol, veh/h	11	5	61	9	2	86	4	95	2313	66	6	24	1862
Future Vol, veh/h	11	5	61	9	2	86	4	95	2313	66	6	24	1862
Conflicting Peds, #/hr	0	0	0	0	0	0	0	0	0	0	0	0	0
Sign Control	Stop	Stop	Stop	Stop	Stop	Free	Free	Free	Free	Free	Free	Free	Free
RT Channelized	-	-	None	-	-	None	-	-	None	-	-	-	None
Storage Length	-	-	-	-	-	0	-	150	-	-	150	-	-
Veh in Median Storage, #	-	1	-	-	1	-	-	0	-	-	0	-	0
Grade, %	-	0	-	-	0	-	-	0	-	-	0	-	-
Peak Hour Factor	97	97	97	97	97	97	97	97	97	97	97	97	97
Heavy Vehicles, %	2	2	2	2	2	2	2	2	2	2	2	2	2
Mvmt Flow	11	5	63	9	2	89	4	98	2385	68	6	25	1920

Major/Minor	Minor2	Minor1	Major1	Major2									
Conflicting Flow All	3177	4675	996	3456	4676	1227	1453	1991	0	0	1790	2453	0
Stage 1	2018	2018	-	2623	2623	-	-	-	-	-	-	-	-
Stage 2	1159	2657	-	833	2053	-	-	-	-	-	-	-	-
Critical Hdwy	6.44	6.54	7.14	6.44	6.54	7.14	5.64	5.34	-	-	5.64	5.34	-
Critical Hdwy Stg 1	7.34	5.54	-	7.34	5.54	-	-	-	-	-	-	-	-
Critical Hdwy Stg 2	6.74	5.54	-	6.74	5.54	-	-	-	-	-	-	-	-
Follow-up Hdwy	3.82	4.02	3.92	3.82	4.02	3.92	2.32	3.12	-	-	2.32	3.12	-
Pot Cap-1 Maneuver	*32	*~1	*493	*15	*~1	146	*833	*619	-	-	158	73	-
Stage 1	*506	*481	-	*13	*49	-	-	-	-	-	-	-	-
Stage 2	*187	*47	-	*506	*481	-	-	-	-	-	-	-	-
Platoon blocked, %	1	1	1	1	1	1	1	1	-	-	1	1	-
Mov Cap-1 Maneuver	*~7	*0	*493	*~8	*0	146	*623	*623	-	-	71	71	-
Mov Cap-2 Maneuver	*24	*7	-	*10	*30	-	-	-	-	-	-	-	-
Stage 1	*423	*272	-	*11	*41	-	-	-	-	-	-	-	-
Stage 2	*58	*39	-	*244	*272	-	-	-	-	-	-	-	-

Approach	EB	WB	NB	SB
HCM Control Delay, s	351.1	137.5	0.5	1.4
HCM LOS	F	F		

Minor Lane/Major Mvmt	NBL	NBT	NBR	EBLn1	WBLn1	WBLn2	SBL	SBT	SBR
Capacity (veh/h)	*623	-	-	59	11	146	71	-	-
HCM Lane V/C Ratio	0.164	-	-	1.345	1.031	0.607	0.436	-	-
HCM Control Delay (s)	11.9	-	-	\$ 351.1	\$ 728.9	61.9	89.7	-	-
HCM Lane LOS	B	-	-	F	F	F	F	-	-
HCM 95th %tile Q(veh)	0.6	-	-	6.9	2.1	3.2	1.7	-	-

Notes  
 ~: Volume exceeds capacity    \$: Delay exceeds 300s    +: Computation Not Defined    \*: All major volume in platoon

Pepper Square TIA  
HCM 6th TWSC

Phase 1 & P - 2028 Background + Site - PM  
20: Preston & Drive 2

Intersection						
Int Delay, s/veh	0.5					
Movement	WBL	WBR	NBT	NBR	SBL	SBT
Lane Configurations		↔	↔	↔	↔	↔
Traffic Vol, veh/h	0	46	2361	40	0	2047
Future Vol, veh/h	0	46	2361	40	0	2047
Conflicting Peds, #/hr	0	0	0	0	0	0
Sign Control	Stop	Stop	Free	Free	Free	Free
RT Channelized	-	None	-	None	-	None
Storage Length	-	0	-	-	-	-
Veh in Median Storage, #	0	-	0	-	-	0
Grade, %	0	-	0	-	-	0
Peak Hour Factor	95	95	95	95	95	95
Heavy Vehicles, %	2	2	2	2	2	2
Mvmt Flow	0	48	2485	42	0	2155

Major/Minor	Minor1	Major1	Major2				
Conflicting Flow All	-	1264	0	0	-	-	-
Stage 1	-	-	-	-	-	-	-
Stage 2	-	-	-	-	-	-	-
Critical Hdwy	-	7.14	-	-	-	-	-
Critical Hdwy Stg 1	-	-	-	-	-	-	-
Critical Hdwy Stg 2	-	-	-	-	-	-	-
Follow-up Hdwy	-	3.92	-	-	-	-	-
Pot Cap-1 Maneuver	0	138	-	-	0	-	-
Stage 1	0	-	-	-	0	-	-
Stage 2	0	-	-	-	0	-	-
Platoon blocked, %	-	-	-	-	-	-	-
Mov Cap-1 Maneuver	-	138	-	-	-	-	-
Mov Cap-2 Maneuver	-	-	-	-	-	-	-
Stage 1	-	-	-	-	-	-	-
Stage 2	-	-	-	-	-	-	-

Approach	WB	NB	SB
HCM Control Delay, s	44.6	0	0
HCM LOS	E		

Minor Lane/Major Mvmt	NBT	NBR	WBLn1	SBT
Capacity (veh/h)	-	-	138	-
HCM Lane V/C Ratio	-	-	0.351	-
HCM Control Delay (s)	-	-	44.6	-
HCM Lane LOS	-	-	E	-
HCM 95th %tile Q(veh)	-	-	1.4	-

Pepper Square TIA  
HCM 6th TWSC

Phase 1 & P - 2028 Background + Site - PM  
21: Preston & Drive 1

Intersection						
Int Delay, s/veh	0					
Movement	WBL	WBR	NBT	NBR	SBL	SBT
Lane Configurations		↑ ↑ ↑	↑ ↑ ↑			↑ ↑ ↑
Traffic Vol, veh/h	0	2	2478	2	0	1884
Future Vol, veh/h	0	2	2478	2	0	1884
Conflicting Peds, #/hr	0	0	0	0	0	0
Sign Control	Stop	Stop	Free	Free	Free	Free
RT Channelized	-	None	-	None	-	None
Storage Length	-	0	-	-	-	-
Veh in Median Storage, #	0	-	0	-	0	0
Grade, %	0	-	0	-	0	0
Peak Hour Factor	95	95	95	95	95	95
Heavy Vehicles, %	2	2	2	2	2	2
Mvmt Flow	0	2	2608	2	0	1983

Major/Minor	Minor1	Major1	Major2		
Conflicting Flow All	-	1305	0	0	-
Stage 1	-	-	-	-	-
Stage 2	-	-	-	-	-
Critical Hdwy	-	7.14	-	-	-
Critical Hdwy Stg 1	-	-	-	-	-
Critical Hdwy Stg 2	-	-	-	-	-
Follow-up Hdwy	-	3.92	-	-	-
Pot Cap-1 Maneuver	0	129	-	0	-
Stage 1	0	-	-	0	-
Stage 2	0	-	-	0	-
Platoon blocked, %	-	-	-	-	-
Mov Cap-1 Maneuver	-	129	-	-	-
Mov Cap-2 Maneuver	-	-	-	-	-
Stage 1	-	-	-	-	-
Stage 2	-	-	-	-	-

Approach	WB	NB	SB
HCM Control Delay, s	33.4	0	0
HCM LOS	D		

Minor Lane/Major Mvmt	NBT	NBRWBLn1	SBT
Capacity (veh/h)	-	-	129
HCM Lane V/C Ratio	-	-	0.016
HCM Control Delay (s)	-	-	33.4
HCM Lane LOS	-	-	D
HCM 95th %tile Q(veh)	-	-	0.1

Pepper Square TIA  
HCM 6th TWSC

Phase 1 & P - 2028 Background + Site - PM  
22: Drive 6 & Belt Line

Intersection						
Int Delay, s/veh	0.1					
Movement	EBT	EBR	WBL	WBT	NBL	NBR
Lane Configurations	↑ ↑ ↑			↑ ↑ ↑		↑
Traffic Vol, veh/h	1294	8	0	962	0	8
Future Vol, veh/h	1294	8	0	962	0	8
Conflicting Peds, #/hr	0	0	0	0	0	0
Sign Control	Free	Free	Free	Free	Stop	Stop
RT Channelized	-	None	-	None	-	None
Storage Length	-	-	-	-	-	0
Veh in Median Storage, #	0	-	-	0	0	-
Grade, %	0	-	-	0	0	-
Peak Hour Factor	93	93	93	93	93	93
Heavy Vehicles, %	2	2	2	2	2	2
Mvmt Flow	1391	9	0	1034	0	9

Major/Minor	Major1	Major2	Minor1		
Conflicting Flow All	0	0	-	-	700
Stage 1	-	-	-	-	-
Stage 2	-	-	-	-	-
Critical Hdwy	-	-	-	-	7.14
Critical Hdwy Stg 1	-	-	-	-	-
Critical Hdwy Stg 2	-	-	-	-	-
Follow-up Hdwy	-	-	-	-	3.92
Pot Cap-1 Maneuver	-	-	0	-	327
Stage 1	-	-	0	-	0
Stage 2	-	-	0	-	0
Platoon blocked, %	-	-	-	-	-
Mov Cap-1 Maneuver	-	-	-	-	327
Mov Cap-2 Maneuver	-	-	-	-	-
Stage 1	-	-	-	-	-
Stage 2	-	-	-	-	-

Approach	EB	WB	NB
HCM Control Delay, s	0	0	16.3
HCM LOS			C

Minor Lane/Major Mvmt	NBLn1	EBT	EBR	WBT
Capacity (veh/h)	327	-	-	-
HCM Lane V/C Ratio	0.026	-	-	-
HCM Control Delay (s)	16.3	-	-	-
HCM Lane LOS	C	-	-	-
HCM 95th %tile Q(veh)	0.1	-	-	-

Pepper Square TIA  
HCM 6th TWSC

Phase 1 & P - 2028 Background + Site - PM  
24: Drive 5 & Belt Line

Intersection						
Int Delay, s/veh	0					
Movement	EBT	EBR	WBL	WBT	NBL	NBR
Lane Configurations	↑↑↑			↑↑↑		↑
Traffic Vol, veh/h	1276	0	0	917	0	5
Future Vol, veh/h	1276	0	0	917	0	5
Conflicting Peds, #/hr	0	0	0	0	0	0
Sign Control	Free	Free	Free	Free	Stop	Stop
RT Channelized	-	None	-	None	-	None
Storage Length	-	-	-	-	-	0
Veh in Median Storage, #	0	-	-	0	0	-
Grade, %	0	-	-	0	0	-
Peak Hour Factor	93	93	93	93	93	93
Heavy Vehicles, %	2	2	2	2	2	2
Mvmt Flow	1372	0	0	986	0	5

Major/Minor	Major1	Major2	Minor1
Conflicting Flow All	0	0	- 686
Stage 1	-	-	-
Stage 2	-	-	-
Critical Hdwy	-	-	- 7.14
Critical Hdwy Stg 1	-	-	-
Critical Hdwy Stg 2	-	-	-
Follow-up Hdwy	-	-	- 3.92
Pot Cap-1 Maneuver	-	0	0 334
Stage 1	-	0	0
Stage 2	-	0	0
Platoon blocked, %	-	-	-
Mov Cap-1 Maneuver	-	-	- 334
Mov Cap-2 Maneuver	-	-	-
Stage 1	-	-	-
Stage 2	-	-	-

Approach	EB	WB	NB
HCM Control Delay, s	0	0	16
HCM LOS			C

Minor Lane/Major Mvmt	NBLn1	EBT	EBR	WBT
Capacity (veh/h)	334	-	-	-
HCM Lane V/C Ratio	0.016	-	-	-
HCM Control Delay (s)	16	-	-	-
HCM Lane LOS	C	-	-	-
HCM 95th %tile Q(veh)	0	-	-	-

Pepper Square TIA  
HCM 6th TWSC

Phase 1 & P - 2028 Background + Site - PM  
25: Preston & Drive 4

Intersection						
Int Delay, s/veh	0.1					
Movement	WBL	WBR	NBT	NBR	SBL	SBT
Lane Configurations		↑↑↑	↑↑↑			↑↑↑
Traffic Vol, veh/h	0	10	2479	9	0	2058
Future Vol, veh/h	0	10	2479	9	0	2058
Conflicting Peds, #/hr	0	0	0	0	0	0
Sign Control	Stop	Stop	Free	Free	Free	Free
RT Channelized	-	None	-	None	-	None
Storage Length	-	0	-	-	-	-
Veh in Median Storage, #	0	-	0	-	0	0
Grade, %	0	-	0	-	0	-
Peak Hour Factor	95	95	95	95	95	95
Heavy Vehicles, %	2	2	2	2	2	2
Mvmt Flow	0	11	2609	9	0	2166

Major/Minor	Minor1	Major1	Major2
Conflicting Flow All	- 1309	0	0
Stage 1	-	-	-
Stage 2	-	-	-
Critical Hdwy	- 7.14	-	-
Critical Hdwy Stg 1	-	-	-
Critical Hdwy Stg 2	-	-	-
Follow-up Hdwy	- 3.92	-	-
Pot Cap-1 Maneuver	0	128	- 0
Stage 1	0	-	- 0
Stage 2	0	-	- 0
Platoon blocked, %	-	-	-
Mov Cap-1 Maneuver	- 128	-	-
Mov Cap-2 Maneuver	-	-	-
Stage 1	-	-	-
Stage 2	-	-	-

Approach	WB	NB	SB
HCM Control Delay, s	35.6	0	0
HCM LOS	E		

Minor Lane/Major Mvmt	NBT	NBRWBLn1	SBT
Capacity (veh/h)	-	- 128	-
HCM Lane V/C Ratio	-	- 0.082	-
HCM Control Delay (s)	-	- 35.6	-
HCM Lane LOS	-	- E	-
HCM 95th %tile Q(veh)	-	- 0.3	-

Intersection						
Int Delay, s/veh	0.3					
Movement	WBL	WBR	NBT	NBR	SBL	SBT
Lane Configurations			↑ ↑ ↑			↑ ↑ ↑
Traffic Vol, veh/h	0	30	2479	18	0	2058
Future Vol, veh/h	0	30	2479	18	0	2058
Conflicting Peds, #/hr	0	0	0	0	0	0
Sign Control	Stop	Stop	Free	Free	Free	Free
RT Channelized	-	None	-	None	-	None
Storage Length	-	0	-	-	-	-
Veh in Median Storage, #	0	-	0	-	-	0
Grade, %	0	-	0	-	-	0
Peak Hour Factor	95	95	95	95	95	95
Heavy Vehicles, %	2	2	2	2	2	2
Mvmt Flow	0	32	2609	19	0	2166

Major/Minor	Minor1	Major1	Major2		
Conflicting Flow All	-	1314	0	0	-
Stage 1	-	-	-	-	-
Stage 2	-	-	-	-	-
Critical Hdwy	-	7.14	-	-	-
Critical Hdwy Stg 1	-	-	-	-	-
Critical Hdwy Stg 2	-	-	-	-	-
Follow-up Hdwy	-	3.92	-	-	-
Pot Cap-1 Maneuver	0	127	-	-	0
Stage 1	0	-	-	-	0
Stage 2	0	-	-	-	0
Platoon blocked, %	-	-	-	-	-
Mov Cap-1 Maneuver	-	127	-	-	-
Mov Cap-2 Maneuver	-	-	-	-	-
Stage 1	-	-	-	-	-
Stage 2	-	-	-	-	-

Approach	WB	NB	SB
HCM Control Delay, s	42.5	0	0
HCM LOS	E		

Minor Lane/Major Mvmt	NBT	NBRWBLn1	SBT
Capacity (veh/h)	-	-	127
HCM Lane V/C Ratio	-	-	0.249
HCM Control Delay (s)	-	-	42.5
HCM Lane LOS	-	-	E
HCM 95th %tile Q(veh)	-	-	0.9



## Synchro™ Output - 2033 Background Traffic



Pepper Square TIA  
Lanes, Volumes, Timings

Phase 1, P, & N - 2033 Background - AM  
4: Berry Trail & Belt Line

Lane Group	EBL	EBT	EBR	WBL	WBT	WBR	NBL	NBT	NBR	SBL	SBT	SBR
Lane Configurations	↔ ↕ ↘	↔ ↕ ↘	↔ ↕ ↘	↔ ↕ ↘	↔ ↕ ↘	↔ ↕ ↘	↔ ↕ ↘	↔ ↕ ↘	↔ ↕ ↘	↔ ↕ ↘	↔ ↕ ↘	↔ ↕ ↘
Traffic Volume (vph)	14	564	4	3	1085	22	1	1	0	36	7	65
Future Volume (vph)	14	564	4	3	1085	22	1	1	0	36	7	65
Ideal Flow (vphpl)	1900	1900	1900	1900	1900	1900	1900	1900	1900	1900	1900	1900
Storage Length (ft)	150	0	150	0	0	0	0	0	0	0	0	0
Storage Lanes	1	0	1	0	1	0	1	0	1	0	1	0
Taper Length (ft)	25		25		25		25		25		25	
Lane Util. Factor	1.00	0.91	0.91	1.00	0.91	0.91	1.00	1.00	1.00	1.00	1.00	1.00
Frt		0.999			0.997						0.864	
Fit Protected	0.950		0.950		0.950		0.950		0.950		0.950	
Satd. Flow (prot)	1770	5080	0	1770	5070	0	1770	1863	0	1770	1609	0
Fit Permitted	0.190		0.386		0.558		0.558		0.558		0.864	
Satd. Flow (perm)	354	5080	0	719	5070	0	1039	1863	0	1863	1609	0
Right Turn on Red		Yes		Yes		Yes		Yes		Yes		Yes
Satd. Flow (RTOR)		1		3		76		76		76		76
Link Speed (mph)	42		42		30		30		30		30	
Link Distance (ft)	234		493		277		236		236		236	
Travel Time (s)	3.8		8.0		6.3		5.4		5.4		5.4	
Peak Hour Factor	0.85	0.85	0.85	0.85	0.85	0.85	0.85	0.85	0.85	0.85	0.85	0.85
Adj. Flow (vph)	16	664	5	4	1276	26	1	1	0	42	8	76
Shared Lane Traffic (%)												
Lane Group Flow (vph)	16	669	0	4	1302	0	1	1	0	42	84	0
Enter Blocked Intersection	No	No	No	No	No	No	No	No	No	No	No	No
Lane Alignment	Left	Left	Right	Left	Left	Right	Left	Left	Right	Left	Left	Right
Median Width(ft)	12		12		12		12		12		12	
Link Offset(ft)	0		0		0		0		0		0	
Crosswalk Width(ft)	16		16		16		16		16		16	
Two way Left Turn Lane												
Headway Factor	1.00	1.00	1.00	1.00	1.00	1.00	1.00	1.00	1.00	1.00	1.00	1.00
Turning Speed (mph)	15		9	15		9	15		9	15		9
Number of Detectors	1	2		1	2		1	2		1	2	
Detector Template	Left	Thru		Left	Thru		Left	Thru		Left	Thru	
Leading Detector (ft)	20	100		20	100		20	100		20	100	
Trailing Detector (ft)	0	0		0	0		0	0		0	0	
Detector 1 Position(ft)	0	0		0	0		0	0		0	0	
Detector 1 Size(ft)	20	6		20	6		20	6		20	6	
Detector 1 Type	Cl+Ex	Cl+Ex		Cl+Ex	Cl+Ex		Cl+Ex	Cl+Ex		Cl+Ex	Cl+Ex	
Detector 1 Channel												
Detector 1 Extend (s)	0.0	0.0		0.0	0.0		0.0	0.0		0.0	0.0	
Detector 1 Queue (s)	0.0	0.0		0.0	0.0		0.0	0.0		0.0	0.0	
Detector 1 Delay (s)	0.0	0.0		0.0	0.0		0.0	0.0		0.0	0.0	
Detector 2 Position(ft)	94		94		94		94		94		94	
Detector 2 Size(ft)	6		6		6		6		6		6	
Detector 2 Type	Cl+Ex		Cl+Ex		Cl+Ex		Cl+Ex		Cl+Ex		Cl+Ex	
Detector 2 Channel												
Detector 2 Extend (s)	0.0		0.0		0.0		0.0		0.0		0.0	
Turn Type	D,P+P	NA		D,P+P	NA		D,P+P	NA		D,P+P	NA	
Protected Phases	3	8		7	4		1	6		5	2	
Permitted Phases	4		8		2		6		6			

Pepper Square TIA  
Lanes, Volumes, Timings

Phase 1, P, & N - 2033 Background - AM  
4: Berry Trail & Belt Line

Lane Group	EBL	EBT	EBR	WBL	WBT	WBR	NBL	NBT	NBR	SBL	SBT	SBR
Detector Phase	3	8		7	4		1	6		5	2	
Switch Phase												
Minimum Initial (s)	4.0	4.0		4.0	4.0		4.0	4.0		4.0	4.0	
Minimum Split (s)	10.0	24.0		10.0	24.0		10.0	31.0		10.0	31.0	
Total Split (s)	15.0	99.0		15.0	99.0		15.0	31.0		15.0	31.0	
Total Split (%)	9.4%	61.9%		9.4%	61.9%		9.4%	19.4%		9.4%	19.4%	
Maximum Green (s)	9.0	93.0		9.0	93.0		9.0	25.0		9.0	25.0	
Yellow Time (s)	4.0	4.0		4.0	4.0		4.0	4.0		4.0	4.0	
All-Red Time (s)	2.0	2.0		2.0	2.0		2.0	2.0		2.0	2.0	
Lost Time Adjust (s)	0.0	0.0		0.0	0.0		0.0	0.0		0.0	0.0	
Total Lost Time (s)	6.0	6.0		6.0	6.0		6.0	6.0		6.0	6.0	
Lead/Lag	Lead	Lag		Lead	Lag		Lead	Lag		Lead	Lag	
Lead-Lag Optimize?	Yes	Yes		Yes	Yes		Yes	Yes		Yes	Yes	
Vehicle Extension (s)	1.0	1.0		1.0	1.0		1.0	1.0		1.0	1.0	
Recall Mode	None	C-Max		None	C-Max		None	None		None	None	
Walk Time (s)		4.0			4.0			4.0			4.0	
Flash Dont Walk (s)		14.0			14.0			21.0			21.0	
Pedestrian Calls (#/hr)		0			0			0			0	
Act Effect Green (s)	135.2	136.8		137.6	132.8		8.0	4.2		8.0	7.2	
Actuated g/C Ratio	0.84	0.86		0.86	0.83		0.05	0.03		0.05	0.04	
v/c Ratio	0.05	0.15		0.01	0.31		0.01	0.02		0.47	0.58	
Control Delay	4.0	4.0		0.7	1.2		66.0	76.0		87.6	34.1	
Queue Delay	0.0	0.0		0.0	0.0		0.0	0.0		0.0	0.0	
Total Delay	4.0	4.0		0.7	1.2		66.0	76.0		87.6	34.1	
LOS	A	A		A	A		E	E		F	C	
Approach Delay		4.0			1.2			71.0			51.9	
Approach LOS		A			A			E			D	
Queue Length 50th (ft)	3	50		0	27		1	1		44	8	
Queue Length 95th (ft)	m8	66		m1	42		8	8		77	59	
Internal Link Dist (ft)		154			413			197			156	
Turn Bay Length (ft)	150			150								
Base Capacity (vph)	385	4344		682	4208		112	291		111	315	
Starvation Cap Reductn	0	0		0	0		0	0		0	0	
Spillback Cap Reductn	0	0		0	0		0	0		0	0	
Storage Cap Reductn	0	0		0	0		0	0		0	0	
Reduced v/c Ratio	0.04	0.15		0.01	0.31		0.01	0.00		0.38	0.27	
Intersection Summary												
Area Type:	Other											
Cycle Length:	160											
Actuated Cycle Length:	160											
Offset:	11 (7%), Referenced to phase 4:EBWB and 8:EBWB, Start of Yellow											
Natural Cycle:	75											
Control Type:	Actuated-Coordinated											
Maximum v/c Ratio:	0.58											
Intersection Signal Delay:	5.1						Intersection LOS: A					
Intersection Capacity Utilization:	40.1%						ICU Level of Service A					
Analysis Period (min):	15											
m Volume for 95th percentile queue is metered by upstream signal.												

Pepper Square TIA  
Lanes, Volumes, Timings

Phase 1, P, & N - 2033 Background - AM  
4: Berry Trail & Belt Line

Splits and Phases: 4: Berry Trail & Belt Line

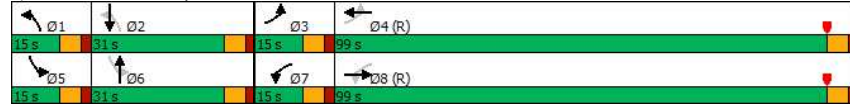

Pepper Square TIA  
Lanes, Volumes, Timings

Phase 1, P, & N - 2033 Background - AM  
1335: Meadow Creek & Belt Line

Lane Group	EBL	EBT	EBR	WBL	WBT	WBR	NBL	NBT	NBR	SBL	SBT	SBR
Lane Configurations	↑↑↑			↑↑↑				↑			↑	
Traffic Volume (vph)	30	801	16	3	1139	18	21	3	6	8	10	84
Future Volume (vph)	30	801	16	3	1139	18	21	3	6	8	10	84
Ideal Flow (vphpl)	1900	1900	1900	1900	1900	1900	1900	1900	1900	1900	1900	1900
Storage Length (ft)	150		0	150		0	0		0	0		0
Storage Lanes	1		0	1		0	0		0	0		0
Taper Length (ft)	25			25			25			25		
Lane Util. Factor	1.00	0.91	0.91	1.00	0.91	0.91	1.00	1.00	1.00	1.00	1.00	1.00
Frt		0.997			0.998			0.975				0.890
Fit Protected	0.950			0.950				0.965				0.996
Satd. Flow (prot)	1770	5070	0	1770	5075	0	0	1753	0	0	1651	0
Fit Permitted	0.197			0.300				0.696				0.978
Satd. Flow (perm)	367	5070	0	559	5075	0	0	1264	0	0	1621	0
Right Turn on Red			Yes			Yes			Yes			Yes
Satd. Flow (RTOR)		4			3			6				90
Link Speed (mph)	42			42			30					30
Link Distance (ft)		1673			2404		392					423
Travel Time (s)		27.2			39.0		8.9					9.6
Peak Hour Factor	0.93	0.93	0.93	0.93	0.93	0.93	0.93	0.93	0.93	0.93	0.93	0.93
Adj. Flow (vph)	32	861	17	3	1225	19	23	3	6	9	11	90
Shared Lane Traffic (%)												
Lane Group Flow (vph)	32	878	0	3	1244	0	0	32	0	0	110	0
Enter Blocked Intersection	No	No	No	No	No	No	No	No	No	No	No	No
Lane Alignment	Left	Left	Right	Left	Left	Right	Left	Left	Right	Left	Left	Right
Median Width(ft)		12			12			0				0
Link Offset(ft)		0			0			0				0
Crosswalk Width(ft)		16			16			16				16
Two way Left Turn Lane												
Headway Factor	1.00	1.00	1.00	1.00	1.00	1.00	1.00	1.00	1.00	1.00	1.00	1.00
Turning Speed (mph)	15		9	15		9	15		9	15		9
Number of Detectors	1	1		1	1		1	1		1	1	
Detector Template												
Leading Detector (ft)	50	50		50	50		50	50		50	50	
Trailing Detector (ft)	0	0		0	0		0	0		0	0	
Detector 1 Position(ft)	0	0		0	0		0	0		0	0	
Detector 1 Size(ft)	50	50		50	50		50	50		50	50	
Detector 1 Type	CI+Ex	CI+Ex		CI+Ex	CI+Ex		CI+Ex	CI+Ex		CI+Ex	CI+Ex	
Detector 1 Channel												
Detector 1 Extend (s)	0.0	0.0		0.0	0.0		0.0	0.0		0.0	0.0	
Detector 1 Queue (s)	0.0	0.0		0.0	0.0		0.0	0.0		0.0	0.0	
Detector 1 Delay (s)	0.0	0.0		0.0	0.0		0.0	0.0		0.0	0.0	
Turn Type	Perm	NA		Perm	NA		Perm	NA		Perm	NA	
Protected Phases		6 14			2 10			4 12			4 12	
Permitted Phases	6 14			2 10		4 12			4 12			
Detector Phase	6 14	6 14		2 10	2 10		4 12	4 12		4 12	4 12	
Switch Phase												
Minimum Initial (s)												
Minimum Split (s)												
Total Split (s)												

Pepper Square TIA  
Lanes, Volumes, Timings

Phase 1, P, & N - 2033 Background - AM  
1335: Meadow Creek & Belt Line

Lane Group	Ø2	Ø4	Ø6	Ø10	Ø12	Ø14
Lane Configurations						
Traffic Volume (vph)						
Future Volume (vph)						
Ideal Flow (vphpl)						
Storage Length (ft)						
Storage Lanes						
Taper Length (ft)						
Lane Util. Factor						
Frt						
Fit Protected						
Satd. Flow (prot)						
Fit Permitted						
Satd. Flow (perm)						
Right Turn on Red						
Satd. Flow (RTOR)						
Link Speed (mph)						
Link Distance (ft)						
Travel Time (s)						
Peak Hour Factor						
Adj. Flow (vph)						
Shared Lane Traffic (%)						
Lane Group Flow (vph)						
Enter Blocked Intersection						
Lane Alignment						
Median Width(ft)						
Link Offset(ft)						
Crosswalk Width(ft)						
Two way Left Turn Lane						
Headway Factor						
Turning Speed (mph)						
Number of Detectors						
Detector Template						
Leading Detector (ft)						
Trailing Detector (ft)						
Detector 1 Position(ft)						
Detector 1 Size(ft)						
Detector 1 Type						
Detector 1 Channel						
Detector 1 Extend (s)						
Detector 1 Queue (s)						
Detector 1 Delay (s)						
Turn Type						
Protected Phases	2	4	6	10	12	14
Permitted Phases						
Detector Phase						
Switch Phase						
Minimum Initial (s)	12.0	6.0	12.0	12.0	12.0	6.0
Minimum Split (s)	17.0	23.5	17.0	20.0	23.0	20.0
Total Split (s)	96.0	22.0	96.0	22.0	20.0	22.0

Pepper Square TIA  
Lanes, Volumes, Timings

Phase 1, P, & N - 2033 Background - AM  
1335: Meadow Creek & Belt Line

Lane Group	EBL	EBT	EBR	WBL	WBT	WBR	NBL	NBT	NBR	SBL	SBT	SBR
Total Split (%)												
Maximum Green (s)												
Yellow Time (s)												
All-Red Time (s)												
Lost Time Adjust (s)												
Total Lost Time (s)												
Lead/Lag												
Lead-Lag Optimize?												
Vehicle Extension (s)												
Recall Mode												
Walk Time (s)												
Flash Dont Walk (s)												
Pedestrian Calls (#/hr)												
Act Effect Green (s)	122.1	122.1		122.1	122.1			21.9				21.9
Actuated g/C Ratio	0.76	0.76		0.76	0.76			0.14				0.14
v/c Ratio	0.11	0.23		0.01	0.32			0.18				0.37
Control Delay	2.3	1.5		0.3	0.3			39.7				15.4
Queue Delay	0.0	0.0		0.0	0.0			0.0				0.0
Total Delay	2.3	1.5		0.3	0.3			39.7				15.4
LOS	A	A		A	A			D				B
Approach Delay		1.6			0.3			39.7				15.4
Approach LOS		A			A			D				B
Queue Length 50th (ft)	2	15		0	6			21				16
Queue Length 95th (ft)	3	17		m0	m5			48				64
Internal Link Dist (ft)		1593			2324			312				343
Turn Bay Length (ft)	150			150								
Base Capacity (vph)	290	4007		441	4011			273				415
Starvation Cap Reductn	0	0		0	0			0				0
Spillback Cap Reductn	0	0		0	0			0				0
Storage Cap Reductn	0	0		0	0			0				0
Reduced v/c Ratio	0.11	0.22		0.01	0.31			0.12				0.27

Intersection Summary

Area Type: Other  
 Cycle Length: 160  
 Actuated Cycle Length: 160  
 Offset: 82 (51%), Referenced to phase 2:WBTL and 6:EBTL, Start of Yellow  
 Natural Cycle: 85  
 Control Type: Actuated-Coordinated  
 Maximum v/c Ratio: 0.37  
 Intersection Signal Delay: 2.1 Intersection LOS: A  
 Intersection Capacity Utilization 40.0% ICU Level of Service A  
 Analysis Period (min) 15  
 m Volume for 95th percentile queue is metered by upstream signal.

Splits and Phases: 1335: Meadow Creek & Belt Line

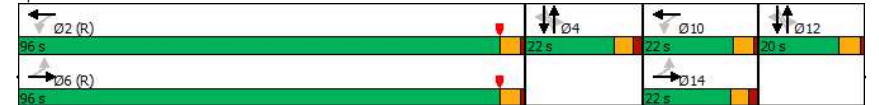

Pepper Square TIA  
Lanes, Volumes, Timings

Phase 1, P, & N - 2033 Background - AM  
1335: Meadow Creek & Belt Line

Lane Group	Ø2	Ø4	Ø6	Ø10	Ø12	Ø14
Total Split (%)	60%	14%	60%	14%	13%	14%
Maximum Green (s)	91.0	16.5	91.0	17.0	15.0	16.5
Yellow Time (s)	4.0	3.7	4.0	4.0	4.0	3.7
All-Red Time (s)	1.0	1.8	1.0	1.0	1.0	1.8
Lost Time Adjust (s)						
Total Lost Time (s)						
Lead/Lag						
Lead-Lag Optimize?						
Vehicle Extension (s)	2.0	1.8	2.0	2.0	1.8	2.0
Recall Mode	C-Max	None	C-Min	None	None	None
Walk Time (s)	4.0	4.0	4.0	4.0	4.0	4.0
Flash Dont Walk (s)	8.0	14.0	8.0	8.0	14.0	8.0
Pedestrian Calls (#/hr)	0	0	0	0	0	0
Act Effect Green (s)						
Actuated g/C Ratio						
v/c Ratio						
Control Delay						
Queue Delay						
Total Delay						
LOS						
Approach Delay						
Approach LOS						
Queue Length 50th (ft)						
Queue Length 95th (ft)						
Internal Link Dist (ft)						
Turn Bay Length (ft)						
Base Capacity (vph)						
Starvation Cap Reductn						
Spillback Cap Reductn						
Storage Cap Reductn						
Reduced v/c Ratio						
Intersection Summary						

Pepper Square TIA  
Lanes, Volumes, Timings

Phase 1, P, & N - 2033 Background - AM  
1365: Preston & Arapah

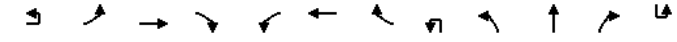

Lane Group	EBU	EBL	EBT	EBR	WBL	WBT	WBR	NBU	NBL	NBT	NBR	SBU
Lane Configurations		↔	↔		↔	↔			↔	↔		
Traffic Volume (vph)	3	146	299	159	127	771	174	1	155	1798	115	4
Future Volume (vph)	3	146	299	159	127	771	174	1	155	1798	115	4
Ideal Flow (vphpl)	1900	1900	1900	1900	1900	1900	1900	1900	1900	1900	1900	1900
Storage Length (ft)		150		0	150		0		300		0	
Storage Lanes		2		0	2		0		2		0	
Taper Length (ft)		25			25				25			
Lane Util. Factor	0.91	0.97	0.91	0.91	0.97	0.91	0.91	0.91	0.97	0.91	0.91	0.91
Frt			0.948			0.972				0.991		
Fit Protected		0.950			0.950				0.950			
Satd. Flow (prot)	0	3433	4821	0	3433	4943	0	0	3433	5040	0	0
Fit Permitted		0.950			0.950				0.950			
Satd. Flow (perm)	0	3433	4821	0	3433	4943	0	0	3433	5040	0	0
Right Turn on Red			Yes			Yes				Yes		
Satd. Flow (RTOR)			80			32				8		
Link Speed (mph)		42			42				42			
Link Distance (ft)		1672			1942				3054			
Travel Time (s)		27.1			31.5				49.6			
Peak Hour Factor	0.95	0.95	0.95	0.95	0.95	0.95	0.95	0.95	0.95	0.95	0.95	0.95
Adj. Flow (vph)	3	154	315	167	134	812	183	1	163	1893	121	4
Shared Lane Traffic (%)												
Lane Group Flow (vph)	0	157	482	0	134	995	0	0	164	2014	0	0
Enter Blocked Intersection	No	No	No	No	No	No	No	No	No	No	No	No
Lane Alignment	R NA	Left	Left	Right	Left	Left	Right	R NA	Left	Left	Right	R NA
Median Width(ft)		24			24				24			
Link Offset(ft)		0			0				0			
Crosswalk Width(ft)			16			16					16	
Two way Left Turn Lane												
Headway Factor	1.00	1.00	1.00	1.00	1.00	1.00	1.00	1.00	1.00	1.00	1.00	1.00
Turning Speed (mph)	9	15		9	15		9	9	15		9	9
Number of Detectors	1	1	1		1	1		1	1	1		1
Detector Template												
Leading Detector (ft)	50	50	50		50	50		50	50	50		50
Trailing Detector (ft)	0	0	0		0	0		0	0	0		0
Detector 1 Position(ft)	0	0	0		0	0		0	0	0		0
Detector 1 Size(ft)	50	50	50		50	50		50	50	50		50
Detector 1 Type	CI+Ex	CI+Ex	CI+Ex		CI+Ex	CI+Ex		CI+Ex	CI+Ex	CI+Ex		CI+Ex
Detector 1 Channel												
Detector 1 Extend (s)	0.0	0.0	0.0		0.0	0.0		0.0	0.0	0.0		0.0
Detector 1 Queue (s)	0.0	0.0	0.0		0.0	0.0		0.0	0.0	0.0		0.0
Detector 1 Delay (s)	0.0	0.0	0.0		0.0	0.0		0.0	0.0	0.0		0.0
Turn Type	Prot	Prot	NA		Prot	NA		Prot	Prot	NA		Prot
Protected Phases	3	3	8		7	4		1	1	6		5
Permitted Phases												
Detector Phase	3	3	8		7	4		1	1	6		5
Switch Phase												
Minimum Initial (s)	3.0	3.0	18.0		3.0	18.0		3.0	3.0	18.0		3.0
Minimum Split (s)	10.0	10.0	36.7		21.0	36.3		10.0	10.0	35.7		10.0
Total Split (s)	13.0	13.0	44.0		18.0	49.0		14.0	14.0	78.0		20.0

Pepper Square TIA  
Lanes, Volumes, Timings

Phase 1, P, & N - 2033 Background - AM  
1365: Preston & Arapaho

Lane Group	SBL	SBT	SBR
Lane Configurations	↑↑	↑↑↑	
Traffic Volume (vph)	104	1901	227
Future Volume (vph)	104	1901	227
Ideal Flow (vphpl)	1900	1900	1900
Storage Length (ft)	250		0
Storage Lanes	2		0
Taper Length (ft)	25		
Lane Util. Factor	0.97	0.91	0.91
Frt		0.984	
Fit Protected	0.950		
Satd. Flow (prot)	3433	5004	0
Fit Permitted	0.950		
Satd. Flow (perm)	3433	5004	0
Right Turn on Red			Yes
Satd. Flow (RTOR)		18	
Link Speed (mph)		48	
Link Distance (ft)		5087	
Travel Time (s)		72.3	
Peak Hour Factor	0.95	0.95	0.95
Adj. Flow (vph)	109	2001	239
Shared Lane Traffic (%)			
Lane Group Flow (vph)	113	2240	0
Enter Blocked Intersection	No	No	No
Lane Alignment	Left	Left	Right
Median Width(ft)		24	
Link Offset(ft)		0	
Crosswalk Width(ft)		16	
Two way Left Turn Lane			
Headway Factor	1.00	1.00	1.00
Turning Speed (mph)	15		9
Number of Detectors	1	1	
Detector Template			
Leading Detector (ft)	50	50	
Trailing Detector (ft)	0	0	
Detector 1 Position(ft)	0	0	
Detector 1 Size(ft)	50	50	
Detector 1 Type	CI+Ex	CI+Ex	
Detector 1 Channel			
Detector 1 Extend (s)	0.0	0.0	
Detector 1 Queue (s)	0.0	0.0	
Detector 1 Delay (s)	0.0	0.0	
Turn Type	Prot	NA	
Protected Phases	5	2	
Permitted Phases			
Detector Phase	5	2	
Switch Phase			
Minimum Initial (s)	3.0	18.0	
Minimum Split (s)	10.0	37.7	
Total Split (s)	20.0	84.0	

09/22/2022 10:16 am  
Kimley-Horn

Synchro 11 Report  
Page 9

Pepper Square TIA  
Lanes, Volumes, Timings

Phase 1, P, & N - 2033 Background - AM  
1365: Preston & Arapaho

Lane Group	EBU	EBL	EBT	EBR	WBL	WBT	WBR	NBU	NBL	NBT	NBR	SBU
Total Split (%)	8.1%	8.1%	27.5%		11.3%	30.6%		8.8%	8.8%	48.8%		12.5%
Maximum Green (s)	7.5	7.5	38.7		12.5	43.7		8.5	8.5	72.3		14.5
Yellow Time (s)	3.0	3.0	4.3		3.0	4.3		3.0	3.0	4.7		3.0
All-Red Time (s)	2.5	2.5	1.0		2.5	1.0		2.5	2.5	1.0		2.5
Lost Time Adjust (s)		-1.0	-1.4		-1.0	-1.0		-1.0	-1.0	-1.7		
Total Lost Time (s)		4.5	3.9		4.5	4.3		4.5	4.5	4.0		
Lead/Lag	Lead	Lead	Lag		Lead	Lag		Lead	Lead	Lead		Lag
Lead-Lag Optimize?	Yes	Yes	Yes		Yes	Yes		Yes	Yes	Yes		Yes
Vehicle Extension (s)	0.8	0.8	2.5		0.8	1.8		1.5	1.5	1.7		1.5
Recall Mode	None	None	Max		None	None		None	None	Max		None
Walk Time (s)			4.0			4.0				4.0		
Flash Dont Walk (s)			27.0			27.0				26.0		
Pedestrian Calls (#/hr)			0			0				0		
Act Effect Green (s)		8.5	43.2		10.4	44.7			9.5	74.0		
Actuated g/C Ratio		0.05	0.27		0.06	0.28			0.06	0.46		
v/c Ratio		0.86	0.35		0.60	0.71			0.81	0.86		
Control Delay		110.3	39.5		79.1	63.3			95.4	25.2		
Queue Delay		0.0	0.0		0.0	0.0			0.0	0.0		
Total Delay		110.3	39.5		79.1	63.3			95.4	25.2		
LOS		F	D		E	E			F	C		
Approach Delay			56.9			65.1				30.5		
Approach LOS			E			E				C		
Queue Length 50th (ft)		86	124		72	376			81	740		
Queue Length 95th (ft)		#156	160		108	437			m#111	791		
Internal Link Dist (ft)			1592			1862				2974		
Turn Bay Length (ft)		150			150				300			
Base Capacity (vph)		182	1359		289	1404			203	2335		
Starvation Cap Reductn		0	0		0	0			0	0		
Spillback Cap Reductn		0	0		0	0			0	0		
Storage Cap Reductn		0	0		0	0			0	0		
Reduced v/c Ratio		0.86	0.35		0.46	0.71			0.81	0.86		

Intersection Summary

Area Type: Other  
 Cycle Length: 160  
 Actuated Cycle Length: 160  
 Offset: 11 (7%), Referenced to phase 2:SBT, Start of Yellow  
 Natural Cycle: 130  
 Control Type: Actuated-Coordinated  
 Maximum v/c Ratio: 0.89  
 Intersection Signal Delay: 46.4  
 Intersection LOS: D  
 Intersection Capacity Utilization 83.7%  
 ICU Level of Service E  
 Analysis Period (min) 15  
 # 95th percentile volume exceeds capacity, queue may be longer.  
 Queue shown is maximum after two cycles.  
 m Volume for 95th percentile queue is metered by upstream signal.

Splits and Phases: 1365: Preston & Arapaho

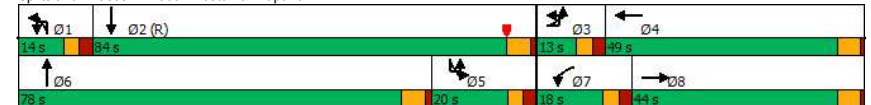

Pepper Square TIA  
Lanes, Volumes, Timings

Phase 1, P, & N - 2033 Background - AM  
1365: Preston & Arapaho

Lane Group	SBL	SBT	SBR
Total Split (%)	12.5%	52.5%	
Maximum Green (s)	14.5	78.3	
Yellow Time (s)	3.0	4.7	
All-Red Time (s)	2.5	1.0	
Lost Time Adjust (s)	-1.0	-1.7	
Total Lost Time (s)	4.5	4.0	
Lead/Lag	Lag	Lag	
Lead-Lag Optimize?	Yes	Yes	
Vehicle Extension (s)	1.5	1.5	
Recall Mode	None	C-Max	
Walk Time (s)		4.0	
Flash Dont Walk (s)		28.0	
Pedestrian Calls (#/hr)		0	
Act Effect Green (s)	15.5	80.0	
Actuated g/C Ratio	0.10	0.50	
v/c Ratio	0.34	0.89	
Control Delay	79.2	47.8	
Queue Delay	0.0	0.0	
Total Delay	79.2	47.8	
LOS	E	D	
Approach Delay		49.3	
Approach LOS		D	
Queue Length 50th (ft)	57	804	
Queue Length 95th (ft)	m72	885	
Internal Link Dist (ft)		5007	
Turn Bay Length (ft)		250	
Base Capacity (vph)	332	2512	
Starvation Cap Reductn	0	0	
Spillback Cap Reductn	0	0	
Storage Cap Reductn	0	0	
Reduced v/c Ratio	0.34	0.89	

Intersection Summary

Pepper Square TIA  
Lanes, Volumes, Timings

Phase 1, P, & N - 2033 Background - AM  
1367: Preston & Belt Line

Lane Group	EBU	EBL	EBT	EBR	WBL	WBT	WBR	NBL	NBT	NBR	SBU	SBL
Lane Configurations		↔	↕	↔	↔	↕	↔	↕	↕	↔	↔	↔
Traffic Volume (vph)	11	171	442	246	70	892	139	322	1719	22	2	151
Future Volume (vph)	11	171	442	246	70	892	139	322	1719	22	2	151
Ideal Flow (vphpl)	1900	1900	1900	1900	1900	1900	1900	1900	1900	1900	1900	1900
Storage Length (ft)		150		150	200		0	250		0		200
Storage Lanes		2		1	1		0	2		0		1
Taper Length (ft)		25			25			25				25
Lane Util. Factor	0.91	0.97	0.91	1.00	1.00	0.91	0.91	0.97	0.91	0.91	0.91	1.00
Fit			0.850		0.980			0.998				
Fit Protected		0.950		0.950		0.950		0.950				0.950
Satd. Flow (prot)	0	3433	5085	1583	1770	4984	0	3433	5075	0	0	1770
Fit Permitted		0.950		0.950		0.950		0.950				0.950
Satd. Flow (perm)	0	3433	5085	1583	1770	4984	0	3433	5075	0	0	1770
Right Turn on Red				Yes		Yes			Yes			
Satd. Flow (RTOR)				203		18			1			
Link Speed (mph)			42			42			42			
Link Distance (ft)			925			394			261			
Travel Time (s)			15.0			6.4			4.2			
Peak Hour Factor	0.95	0.95	0.95	0.95	0.95	0.95	0.95	0.95	0.95	0.95	0.95	0.95
Adj. Flow (vph)	12	180	465	259	74	939	146	339	1809	23	2	159
Shared Lane Traffic (%)												
Lane Group Flow (vph)	0	192	465	259	74	1085	0	339	1832	0	0	161
Enter Blocked Intersection	No	No	No	No	No	No	No	No	No	No	No	No
Lane Alignment	R NA	Left	Left	Right	Left	Left	Right	Left	Left	Right	R NA	Left
Median Width(ft)			24			24			24			
Link Offset(ft)			0			0			0			
Crosswalk Width(ft)				16		16			16			
Two way Left Turn Lane												
Headway Factor	1.00	1.00	1.00	1.00	1.00	1.00	1.00	1.00	1.00	1.00	1.00	1.00
Turning Speed (mph)	9	15		9	15		9	15		9	9	15
Number of Detectors	1	1	1	1	1	1	1	1	1	1	1	1
Detector Template												
Leading Detector (ft)	50	50	50	50	50	50		50	50		50	50
Trailing Detector (ft)	0	0	0	0	0	0		0	0		0	0
Detector 1 Position(ft)	0	0	0	0	0	0		0	0		0	0
Detector 1 Size(ft)	50	50	50	50	50	50		50	50		50	50
Detector 1 Type	CI+Ex	CI+Ex	CI+Ex	CI+Ex	CI+Ex	CI+Ex		CI+Ex	CI+Ex		CI+Ex	CI+Ex
Detector 1 Channel												
Detector 1 Extend (s)	0.0	0.0	0.0	0.0	0.0	0.0		0.0	0.0		0.0	0.0
Detector 1 Queue (s)	0.0	0.0	0.0	0.0	0.0	0.0		0.0	0.0		0.0	0.0
Detector 1 Delay (s)	0.0	0.0	0.0	0.0	0.0	0.0		0.0	0.0		0.0	0.0
Turn Type	Prot	Prot	NA	Perm	Prot	NA		Prot	NA		Prot	Prot
Protected Phases	3	3	8		7	4		1	6		5	5
Permitted Phases				8								
Detector Phase	3	3	8	8	7	4		1	6		5	5
Switch Phase												
Minimum Initial (s)	3.0	3.0	18.0	18.0	3.0	18.0		3.0	18.0		3.0	3.0
Minimum Split (s)	11.0	11.0	32.5	32.5	8.0	32.5		8.0	33.0		11.0	11.0
Total Split (s)	16.0	16.0	42.0	42.0	20.0	46.0		18.0	76.0		22.0	22.0

Pepper Square TIA  
Lanes, Volumes, Timings

Phase 1, P, & N - 2033 Background - AM  
1367: Preston & Belt Line

Lane Group	SBT	SBR
Lane Configurations	↑↑↑	↑
Traffic Volume (vph)	1891	285
Future Volume (vph)	1891	285
Ideal Flow (vphpl)	1900	1900
Storage Length (ft)		300
Storage Lanes		1
Taper Length (ft)		
Lane Util. Factor	0.91	1.00
Frt		0.850
Fit Protected		
Satd. Flow (prot)	5085	1583
Fit Permitted		
Satd. Flow (perm)	5085	1583
Right Turn on Red		Yes
Satd. Flow (RTOR)		175
Link Speed (mph)	40	
Link Distance (ft)	3054	
Travel Time (s)	52.1	
Peak Hour Factor	0.95	0.95
Adj. Flow (vph)	1991	300
Shared Lane Traffic (%)		
Lane Group Flow (vph)	1991	300
Enter Blocked Intersection	No	No
Lane Alignment	Left	Right
Median Width(ft)	24	
Link Offset(ft)	0	
Crosswalk Width(ft)	16	
Two way Left Turn Lane		
Headway Factor	1.00	1.00
Turning Speed (mph)		9
Number of Detectors	1	1
Detector Template		
Leading Detector (ft)	50	50
Trailing Detector (ft)	0	0
Detector 1 Position(ft)	0	0
Detector 1 Size(ft)	50	50
Detector 1 Type	CI+Ex	CI+Ex
Detector 1 Channel		
Detector 1 Extend (s)	0.0	0.0
Detector 1 Queue (s)	0.0	0.0
Detector 1 Delay (s)	0.0	0.0
Turn Type	NA	Perm
Protected Phases	2	
Permitted Phases		2
Detector Phase	2	2
Switch Phase		
Minimum Initial (s)	18.0	18.0
Minimum Split (s)	33.0	33.0
Total Split (s)	80.0	80.0

Pepper Square TIA  
Lanes, Volumes, Timings

Phase 1, P, & N - 2033 Background - AM  
1367: Preston & Belt Line

Lane Group	EBU	EBL	EBT	EBR	WBL	WBT	WBR	NBL	NBT	NBR	SBU	SBL
Total Split (%)	10.0%	10.0%	26.3%	26.3%	12.5%	28.8%		11.3%	47.5%		13.8%	13.8%
Maximum Green (s)	11.0	11.0	36.5	36.5	15.0	40.5		13.0	70.0		17.0	17.0
Yellow Time (s)	3.0	3.0	4.0	4.0	3.0	4.0		3.0	4.4		3.0	3.0
All-Red Time (s)	2.0	2.0	1.5	1.5	2.0	1.5		2.0	1.6		2.0	2.0
Lost Time Adjust (s)		-1.0	-1.5	-1.5	-1.0	-1.5		-1.0	-1.7			-1.0
Total Lost Time (s)		4.0	4.0	4.0	4.0	4.0		4.0	4.3			4.0
Lead/Lag	Lead	Lead	Lead	Lead	Lag	Lag		Lag	Lag		Lead	Lead
Lead-Lag Optimize?	Yes	Yes	Yes	Yes	Yes	Yes		Yes	Yes		Yes	Yes
Vehicle Extension (s)	1.3	1.3	1.3	1.3	1.0	1.3		1.6	2.0		1.5	1.5
Recall Mode	None	None	Max	Max	None	Max		None	C-Max		None	None
Walk Time (s)			7.0	7.0		7.0			7.0			
Flash Dont Walk (s)			20.0	20.0		20.0			20.0			
Pedestrian Calls (#/hr)			0	0		0			0			
Act Effect Green (s)		11.6	38.0	38.0	16.0	42.4		14.0	72.7			17.0
Actuated g/C Ratio		0.07	0.24	0.24	0.10	0.26		0.09	0.45			0.11
v/c Ratio		0.77	0.39	0.49	0.42	0.81		1.13	0.79			0.86
Control Delay		80.6	43.2	12.2	46.0	30.4		141.6	28.1			108.2
Queue Delay		0.0	0.0	0.0	0.0	0.0		0.0	2.0			0.0
Total Delay		80.6	43.2	12.2	46.0	30.4		141.6	30.1			108.2
LOS		F	D	B	D	C		F	C			F
Approach Delay			42.3			31.4			47.5			
Approach LOS			D			C			D			
Queue Length 50th (ft)		104	157	88	72	350		~215	653			155
Queue Length 95th (ft)		#158	196	173	135	457		#326	792			m193
Internal Link Dist (ft)			845			314			181			
Turn Bay Length (ft)		150		150	200			250				200
Base Capacity (vph)		257	1207	530	177	1333		300	2306			199
Starvation Cap Reductn		0	0	0	0	0		0	313			0
Spillback Cap Reductn		0	0	1	0	0		0	0			0
Storage Cap Reductn		0	0	0	0	0		0	0			0
Reduced v/c Ratio		0.75	0.39	0.49	0.42	0.81		1.13	0.92			0.81
<b>Intersection Summary</b>												
Area Type: Other												
Cycle Length: 160												
Actuated Cycle Length: 160												
Offset: 81 (51%), Referenced to phase 6:NBT, Start of Yellow												
Natural Cycle: 100												
Control Type: Actuated-Coordinated												
Maximum v/c Ratio: 1.13												
Intersection Signal Delay: 34.1												
Intersection Capacity Utilization 84.8%												
ICU Level of Service E												
Analysis Period (min) 15												
~ Volume exceeds capacity, queue is theoretically infinite.												
Queue shown is maximum after two cycles.												
# 95th percentile volume exceeds capacity, queue may be longer.												
Queue shown is maximum after two cycles.												
m Volume for 95th percentile queue is metered by upstream signal.												

Pepper Square TIA  
Lanes, Volumes, Timings

Phase 1, P, & N - 2033 Background - AM  
1367: Preston & Belt Line

Splits and Phases: 1367: Preston & Belt Line

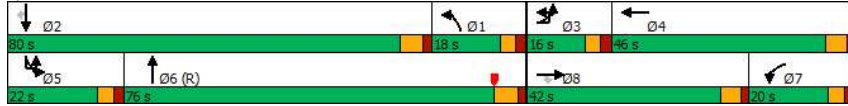

Pepper Square TIA  
Lanes, Volumes, Timings

Phase 1, P, & N - 2033 Background - AM  
1367: Preston & Belt Line

Lane Group	SBT	SBR
Total Split (%)	50.0%	50.0%
Maximum Green (s)	74.0	74.0
Yellow Time (s)	4.4	4.4
All-Red Time (s)	1.6	1.6
Lost Time Adjust (s)	-1.7	-1.7
Total Lost Time (s)	4.3	4.3
Lead/Lag	Lead	Lead
Lead-Lag Optimize?	Yes	Yes
Vehicle Extension (s)	2.5	2.5
Recall Mode	Max	Max
Walk Time (s)	7.0	7.0
Flash Dont Walk (s)	20.0	20.0
Pedestrian Calls (#/hr)	0	0
Act Effct Green (s)	75.7	75.7
Actuated g/C Ratio	0.47	0.47
v/c Ratio	0.83	0.36
Control Delay	16.3	1.4
Queue Delay	0.1	0.0
Total Delay	16.4	1.4
LOS	B	A
Approach Delay	20.6	
Approach LOS	C	
Queue Length 50th (ft)	412	3
Queue Length 95th (ft)	386	m4
Internal Link Dist (ft)	2974	
Turn Bay Length (ft)		300
Base Capacity (vph)	2405	841
Starvation Cap Reductn	0	0
Spillback Cap Reductn	28	0
Storage Cap Reductn	0	0
Reduced v/c Ratio	0.84	0.36
<b>Intersection Summary</b>		



Pepper Square TIA  
Lanes, Volumes, Timings

Phase 1, P, & N - 2033 Background - AM  
1368: Preston & Alexis

Lane Group	EBL	EBT	EBR	WBL	WBT	WBR	NBU	NBL	NBT	NBR	SBL	SBT
Lane Configurations	↔	↔	↔	↔	↔	↔	↔	↔	↔	↔	↔	↔
Traffic Volume (vph)	16	5	29	266	22	125	3	21	1991	96	104	2061
Future Volume (vph)	16	5	29	266	22	125	3	21	1991	96	104	2061
Ideal Flow (vphpl)	1900	1900	1900	1900	1900	1900	1900	1900	1900	1900	1900	1900
Storage Length (ft)	0		0	175		0		150		150	150	
Storage Lanes	1		1	2		1		1		1	1	
Taper Length (ft)	25			25				25			25	
Lane Util. Factor	0.91	0.91	1.00	0.97	1.00	1.00	0.91	1.00	0.91	1.00	1.00	0.91
Frt			0.850			0.850				0.850		
Fit Protected	0.950	0.969		0.950				0.950			0.950	
Satd. Flow (prot)	1610	3285	1583	3433	1863	1583	0	1770	5085	1583	1770	5085
Fit Permitted	0.950	0.969		0.950				0.052			0.051	
Satd. Flow (perm)	1610	3285	1583	3433	1863	1583	0	97	5085	1583	95	5085
Right Turn on Red			Yes			Yes				Yes		
Satd. Flow (RTOR)			125			85				89		
Link Speed (mph)	30			30				43			42	
Link Distance (ft)	660			627				2867			173	
Travel Time (s)	15.0			14.3				45.5			2.8	
Peak Hour Factor	0.92	0.92	0.92	0.92	0.92	0.92	0.92	0.92	0.92	0.92	0.92	0.92
Adj. Flow (vph)	17	5	32	289	24	136	3	23	2164	104	113	2240
Shared Lane Traffic (%)	50%											
Lane Group Flow (vph)	8	14	32	289	24	136	0	26	2164	104	113	2240
Enter Blocked Intersection	No	No	No	No	No	No	No	No	No	No	No	No
Lane Alignment	Left	Left	Right	Left	Left	Right	R NA	Left	Left	Right	Left	Left
Median Width(ft)	24			24				12			12	
Link Offset(ft)	0			0				0			0	
Crosswalk Width(ft)	16			16				16			16	
Two way Left Turn Lane												
Headway Factor	1.00	1.00	1.00	1.00	1.00	1.00	1.00	1.00	1.00	1.00	1.00	1.00
Turning Speed (mph)	15		9	15		9	9	15		9	15	
Number of Detectors	1	1	1	1	1	1	1	1	1	1	1	1
Detector Template												
Leading Detector (ft)	50	50	50	50	50	50	50	50	50	50	50	50
Trailing Detector (ft)	0	0	0	0	0	0	0	0	0	0	0	0
Detector 1 Position(ft)	0	0	0	0	0	0	0	0	0	0	0	0
Detector 1 Size(ft)	50	50	50	50	50	50	50	50	50	50	50	50
Detector 1 Type	Cl+Ex	Cl+Ex	Cl+Ex	Cl+Ex	Cl+Ex	Cl+Ex	Cl+Ex	Cl+Ex	Cl+Ex	Cl+Ex	Cl+Ex	Cl+Ex
Detector 1 Channel												
Detector 1 Extend (s)	0.0	0.0	0.0	0.0	0.0	0.0	0.0	0.0	0.0	0.0	0.0	0.0
Detector 1 Queue (s)	0.0	0.0	0.0	0.0	0.0	0.0	0.0	0.0	0.0	0.0	0.0	0.0
Detector 1 Delay (s)	0.0	0.0	0.0	0.0	0.0	0.0	0.0	0.0	0.0	0.0	0.0	0.0
Turn Type	Split	NA	Perm	Split	NA	pm+ov	custom	D.P+P	NA	Perm	D.P+P	NA
Protected Phases	3	3		4	4	5		1	6		5	2
Permitted Phases			3			4	1	2		6		6
Detector Phase	3	3	3	4	4	5	1	1	6	6	5	2
Switch Phase												
Minimum Initial (s)	6.0	6.0	6.0	8.0	8.0	3.0	3.0	3.0	14.0	14.0	3.0	14.0
Minimum Split (s)	27.0	27.0	27.0	27.0	27.0	8.4	8.4	8.4	24.0	24.0	8.4	24.0
Total Split (s)	13.0	13.0	13.0	29.0	29.0	15.0	18.0	18.0	103.0	103.0	15.0	100.0

Pepper Square TIA  
Lanes, Volumes, Timings

Phase 1, P, & N - 2033 Background - AM  
1368: Preston & Alexis

Lane Group	SBR
Lane Configurations	↔
Traffic Volume (vph)	23
Future Volume (vph)	23
Ideal Flow (vphpl)	1900
Storage Length (ft)	150
Storage Lanes	1
Taper Length (ft)	
Lane Util. Factor	1.00
Frt	0.850
Fit Protected	
Satd. Flow (prot)	1583
Fit Permitted	
Satd. Flow (perm)	1583
Right Turn on Red	Yes
Satd. Flow (RTOR)	78
Link Speed (mph)	
Link Distance (ft)	
Travel Time (s)	
Peak Hour Factor	0.92
Adj. Flow (vph)	25
Shared Lane Traffic (%)	
Lane Group Flow (vph)	25
Enter Blocked Intersection	No
Lane Alignment	Right
Median Width(ft)	
Link Offset(ft)	
Crosswalk Width(ft)	
Two way Left Turn Lane	
Headway Factor	1.00
Turning Speed (mph)	9
Number of Detectors	1
Detector Template	
Leading Detector (ft)	50
Trailing Detector (ft)	0
Detector 1 Position(ft)	0
Detector 1 Size(ft)	50
Detector 1 Type	Cl+Ex
Detector 1 Channel	
Detector 1 Extend (s)	0.0
Detector 1 Queue (s)	0.0
Detector 1 Delay (s)	0.0
Turn Type	Perm
Protected Phases	
Permitted Phases	2
Detector Phase	2
Switch Phase	
Minimum Initial (s)	14.0
Minimum Split (s)	24.0
Total Split (s)	100.0

Pepper Square TIA  
Lanes, Volumes, Timings

Phase 1, P, & N - 2033 Background - AM  
1368: Preston & Alexis

Lane Group	EBL	EBT	EBR	WBL	WBT	WBR	NBU	NBL	NBT	NBR	SBL	SBT
Total Split (%)	8.1%	8.1%	8.1%	18.1%	18.1%	9.4%	11.3%	11.3%	64.4%	64.4%	9.4%	62.5%
Maximum Green (s)	8.0	8.0	8.0	24.0	24.0	10.6	13.6	13.6	97.0	97.0	10.6	94.0
Yellow Time (s)	4.0	4.0	4.0	4.0	4.0	3.4	3.4	3.4	4.5	4.5	3.4	4.5
All-Red Time (s)	1.0	1.0	1.0	1.0	1.0	1.0	1.0	1.0	1.5	1.5	1.0	1.5
Lost Time Adjust (s)	-1.0	-1.0	0.0	-1.0	-1.0	0.0			-1.0	-2.0	0.0	-2.0
Total Lost Time (s)	4.0	4.0	5.0	4.0	4.0	4.4			3.4	4.0	6.0	3.4
Lead/Lag	Lead	Lead	Lead	Lag	Lag	Lag	Lead	Lead	Lead	Lead	Lag	Lag
Lead-Lag Optimize?	Yes	Yes	Yes	Yes	Yes	Yes	Yes	Yes	Yes	Yes	Yes	Yes
Vehicle Extension (s)	2.0	2.0	2.0	2.0	2.0	1.2	1.2	1.2	2.5	2.5	1.2	2.5
Recall Mode	None	None	None	None	None	None	None	None	Max	Max	None	C-Max
Walk Time (s)	4.0	4.0	4.0	4.0	4.0				4.0	4.0		4.0
Flash Dont Walk (s)	18.0	18.0	18.0	18.0	18.0				14.0	14.0		14.0
Pedestrian Calls (#/hr)	0	0	0	0	0				0	0		0
Act Effect Green (s)	7.2	7.2	6.2	18.8	18.8	29.9		122.8	109.2	107.2	121.4	118.8
Actuated g/C Ratio	0.04	0.04	0.04	0.12	0.12	0.19		0.77	0.68	0.67	0.76	0.74
v/c Ratio	0.11	0.10	0.18	0.72	0.11	0.37		0.20	0.62	0.10	0.59	0.59
Control Delay	76.7	74.6	2.1	78.1	62.5	20.3		7.6	8.3	0.4	28.3	1.6
Queue Delay	0.0	0.0	0.0	0.0	0.0	0.0		0.0	0.0	0.0	0.0	0.0
Total Delay	76.7	74.6	2.1	78.1	62.5	20.3		7.6	8.3	0.4	28.3	1.6
LOS	E	E	A	E	E	C		A	A	A	C	A
Approach Delay		32.0			59.8				7.9			2.9
Approach LOS		C			E				A			A
Queue Length 50th (ft)	8	7	0	152	23	40		3	264	1	55	26
Queue Length 95th (ft)	30	21	0	199	52	95		9	277	0	112	109
Internal Link Dist (ft)		580			547				2787			93
Turn Bay Length (ft)				175				150		150	150	
Base Capacity (vph)	90	184	197	536	291	364		228	3471	1090	193	3776
Starvation Cap Reductn	0	0	0	0	0	0		0	0	0	0	196
Spillback Cap Reductn	0	0	0	0	0	0		0	0	0	0	0
Storage Cap Reductn	0	0	0	0	0	0		0	0	0	0	0
Reduced v/c Ratio	0.09	0.08	0.16	0.54	0.08	0.37		0.11	0.62	0.10	0.59	0.63

Intersection Summary

Area Type: Other  
 Cycle Length: 160  
 Actuated Cycle Length: 160  
 Offset: 89 (56%), Referenced to phase 2:NBSB, Start of Yellow  
 Natural Cycle: 110  
 Control Type: Actuated-Coordinated  
 Maximum v/c Ratio: 0.72  
 Intersection Signal Delay: 10.3 Intersection LOS: B  
 Intersection Capacity Utilization 69.9% ICU Level of Service C  
 Analysis Period (min) 15  
 m Volume for 95th percentile queue is metered by upstream signal.

Splits and Phases: 1368: Preston & Alexis

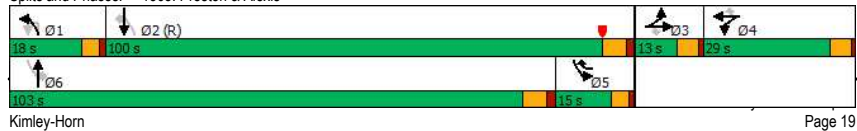

Pepper Square TIA  
Lanes, Volumes, Timings

Phase 1, P, & N - 2033 Background - AM  
1368: Preston & Alexis

Lane Group	SBR
Total Split (%)	62.5%
Maximum Green (s)	94.0
Yellow Time (s)	4.5
All-Red Time (s)	1.5
Lost Time Adjust (s)	0.0
Total Lost Time (s)	6.0
Lead/Lag	Lag
Lead-Lag Optimize?	Yes
Vehicle Extension (s)	2.5
Recall Mode	C-Max
Walk Time (s)	4.0
Flash Dont Walk (s)	14.0
Pedestrian Calls (#/hr)	0
Act Effect Green (s)	116.8
Actuated g/C Ratio	0.73
v/c Ratio	0.02
Control Delay	0.0
Queue Delay	0.0
Total Delay	0.0
LOS	A
Approach Delay	
Approach LOS	
Queue Length 50th (ft)	0
Queue Length 95th (ft)	m0
Internal Link Dist (ft)	
Turn Bay Length (ft)	150
Base Capacity (vph)	1177
Starvation Cap Reductn	0
Spillback Cap Reductn	0
Storage Cap Reductn	0
Reduced v/c Ratio	0.02

Intersection Summary

Area Type: Other  
 Cycle Length: 160  
 Actuated Cycle Length: 160  
 Offset: 89 (56%), Referenced to phase 2:NBSB, Start of Yellow  
 Natural Cycle: 110  
 Control Type: Actuated-Coordinated  
 Maximum v/c Ratio: 0.72  
 Intersection Signal Delay: 10.3 Intersection LOS: B  
 Intersection Capacity Utilization 69.9% ICU Level of Service C  
 Analysis Period (min) 15  
 m Volume for 95th percentile queue is metered by upstream signal.

Pepper Square TIA  
Lanes, Volumes, Timings

Phase 1, P, & N - 2033 Background - AM  
1369: Preston & Belt Line Village Driveway



Lane Group	EBL	EBT	EBR	WBL	WBT	WBR	NBL	NBT	NBR	SBU	SBL	SBT
Lane Configurations		↕↕			↕		↕	↕↕↕			↕	↕↕↕
Traffic Volume (vph)	41	1	29	4	2	0	25	1997	3	3	8	2206
Future Volume (vph)	41	1	29	4	2	0	25	1997	3	3	8	2206
Ideal Flow (vphpl)	1900	1900	1900	1900	1900	1900	1900	1900	1900	1900	1900	1900
Storage Length (ft)	0		0	0		0	100		0		100	
Storage Lanes	0		0	0		0	1		0		1	
Taper Length (ft)	25			25			25				25	
Lane Util. Factor	0.95	0.95	0.95	1.00	1.00	1.00	1.00	0.91	0.91	0.91	1.00	0.91
Fr		0.939										0.998
Fit Protected		0.972			0.968		0.950				0.950	
Satd. Flow (prot)	0	3230	0	0	1803	0	1770	5085	0	0	1770	5075
Fit Permitted		0.804			0.884		0.041				0.052	
Satd. Flow (perm)	0	2672	0	0	1647	0	76	5085	0	0	97	5075
Right Turn on Red			Yes			Yes			Yes			
Satd. Flow (RTOR)		32										2
Link Speed (mph)		30			30			42				38
Link Distance (ft)		303			249			252				191
Travel Time (s)		6.9			5.7			4.1				3.4
Peak Hour Factor	0.90	0.90	0.90	0.90	0.90	0.90	0.90	0.90	0.90	0.90	0.90	0.90
Adj. Flow (vph)	46	1	32	4	2	0	28	2219	3	3	9	2451
Shared Lane Traffic (%)												
Lane Group Flow (vph)	0	79	0	0	6	0	28	2222	0	0	12	2484
Enter Blocked Intersection	No	No	No	No	No	No	No	No	No	No	No	No
Lane Alignment	Left	Left	Right	Left	Left	Right	Left	Left	Right	R NA	Left	Left
Median Width(ft)		0			0			12				12
Link Offset(ft)		0			0			0				0
Crosswalk Width(ft)		16			16			16				16
Two way Left Turn Lane												
Headway Factor	1.00	1.00	1.00	1.00	1.00	1.00	1.00	1.00	1.00	1.00	1.00	1.00
Turning Speed (mph)	15		9	15		9	15		9	9	15	
Number of Detectors	1	1		1	1		1	1		1	1	1
Detector Template												
Leading Detector (ft)	50	50		50	50		50	50		50	50	50
Trailing Detector (ft)	0	0		0	0		0	0		0	0	0
Detector 1 Position(ft)	0	0		0	0		0	0		0	0	0
Detector 1 Size(ft)	50	50		50	50		50	50		50	50	50
Detector 1 Type	CI+Ex	CI+Ex		CI+Ex	CI+Ex		CI+Ex	CI+Ex		CI+Ex	CI+Ex	CI+Ex
Detector 1 Channel												
Detector 1 Extend (s)	0.0	0.0		0.0	0.0		0.0	0.0		0.0	0.0	0.0
Detector 1 Queue (s)	0.0	0.0		0.0	0.0		0.0	0.0		0.0	0.0	0.0
Detector 1 Delay (s)	0.0	0.0		0.0	0.0		0.0	0.0		0.0	0.0	0.0
Turn Type	Perm	NA		Perm	NA		D.P+P	NA		custom	D.P+P	NA
Protected Phases		8			4		1	6			5	2
Permitted Phases	8			4			2			5	6	
Detector Phase	8	8		4	4		1	6		5	5	2
Switch Phase												
Minimum Initial (s)	20.0	20.0		20.0	20.0		5.0	20.0		5.0	5.0	20.0
Minimum Split (s)	25.0	25.0		25.0	25.0		10.0	26.0		10.0	10.0	26.0
Total Split (s)	47.0	47.0		47.0	47.0		20.0	98.0		15.0	15.0	93.0

Pepper Square TIA  
Lanes, Volumes, Timings

Phase 1, P, & N - 2033 Background - AM  
1369: Preston & Belt Line Village Driveway



Lane Group	SBR
Lane Configurations	↕↕↕
Traffic Volume (vph)	30
Future Volume (vph)	30
Ideal Flow (vphpl)	1900
Storage Length (ft)	0
Storage Lanes	0
Taper Length (ft)	
Lane Util. Factor	0.91
Fr	
Fit Protected	
Satd. Flow (prot)	0
Fit Permitted	
Satd. Flow (perm)	0
Right Turn on Red	Yes
Satd. Flow (RTOR)	
Link Speed (mph)	
Link Distance (ft)	
Travel Time (s)	
Peak Hour Factor	0.90
Adj. Flow (vph)	33
Shared Lane Traffic (%)	
Lane Group Flow (vph)	0
Enter Blocked Intersection	No
Lane Alignment	Right
Median Width(ft)	
Link Offset(ft)	
Crosswalk Width(ft)	
Two way Left Turn Lane	
Headway Factor	1.00
Turning Speed (mph)	9
Number of Detectors	
Detector Template	
Leading Detector (ft)	
Trailing Detector (ft)	
Detector 1 Position(ft)	
Detector 1 Size(ft)	
Detector 1 Type	
Detector 1 Channel	
Detector 1 Extend (s)	
Detector 1 Queue (s)	
Detector 1 Delay (s)	
Turn Type	
Protected Phases	
Permitted Phases	
Detector Phase	
Switch Phase	
Minimum Initial (s)	
Minimum Split (s)	
Total Split (s)	

Pepper Square TIA  
Lanes, Volumes, Timings

Phase 1, P, & N - 2033 Background - AM  
1369: Preston & Belt Line Village Driveway



Lane Group	EBL	EBT	EBR	WBL	WBT	WBR	NBL	NBT	NBR	SBU	SBL	SBT
Total Split (%)	29.4%	29.4%		29.4%	29.4%		12.5%	61.3%		9.4%	9.4%	58.1%
Maximum Green (s)	42.3	42.3		42.3	42.3		15.0	93.7		10.0	10.0	88.7
Yellow Time (s)	3.0	3.0		3.0	3.0		3.0	3.0		3.0	3.0	3.0
All-Red Time (s)	1.7	1.7		1.7	1.7		2.0	1.3		2.0	2.0	1.3
Lost Time Adjust (s)		-1.0		-1.0	-1.0		-1.0	-2.0		-1.0	-2.0	
Total Lost Time (s)		3.7		3.7	3.7		4.0	2.3		4.0	2.3	
Lead/Lag							Lead	Lead		Lag	Lag	Lag
Lead-Lag Optimize?							Yes	Yes		Yes	Yes	Yes
Vehicle Extension (s)	2.0	2.0		2.0	2.0		1.5	3.0		1.5	1.5	3.3
Recall Mode	None	None		None	None		None	None		None	None	C-Max
Walk Time (s)	5.0	5.0		5.0	5.0			7.0				7.0
Flash Dont Walk (s)	15.0	15.0		15.0	15.0			8.0				8.0
Pedestrian Calls (#/hr)	0	0		0	0			0				0
Act Effect Green (s)		21.0			21.0		128.9	118.4			129.7	127.0
Actuated g/C Ratio		0.13			0.13		0.81	0.74			0.81	0.79
v/c Ratio		0.21			0.03		0.23	0.59			0.05	0.62
Control Delay		39.3			61.2		11.8	7.1			1.1	3.1
Queue Delay		0.0			0.0		0.0	0.1			0.0	0.1
Total Delay		39.3			61.2		11.8	7.1			1.1	3.2
LOS		D			E		B	A			A	A
Approach Delay		39.3			61.2			7.2				3.2
Approach LOS		D			E			A				A
Queue Length 50th (ft)		23			6		2	41			1	67
Queue Length 95th (ft)		51			22		m3	295			m1	81
Internal Link Dist (ft)		223			169			172				111
Turn Bay Length (ft)								100				100
Base Capacity (vph)		746			445		231	3762			283	4027
Starvation Cap Reductn		0			0		0	107			0	329
Spillback Cap Reductn		0			0		0	322			0	0
Storage Cap Reductn		0			0		0	0			0	0
Reduced v/c Ratio		0.11			0.01		0.12	0.65			0.04	0.67

Intersection Summary

Area Type: Other  
 Cycle Length: 160  
 Actuated Cycle Length: 160  
 Offset: 86 (54%), Referenced to phase 2:NBSB, Start of Yellow  
 Natural Cycle: 75  
 Control Type: Actuated-Coordinated  
 Maximum v/c Ratio: 0.62  
 Intersection Signal Delay: 5.7 Intersection LOS: A  
 Intersection Capacity Utilization 66.6% ICU Level of Service C  
 Analysis Period (min) 15  
 m Volume for 95th percentile queue is metered by upstream signal.

Splits and Phases: 1369: Preston & Belt Line Village Driveway

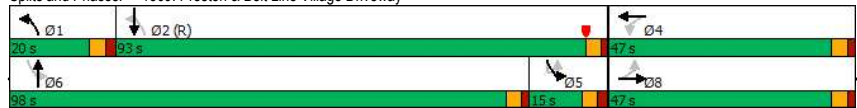

Pepper Square TIA  
Lanes, Volumes, Timings

Phase 1, P, & N - 2033 Background - AM  
1369: Preston & Belt Line Village Driveway



Lane Group	SBR
Total Split (%)	
Maximum Green (s)	
Yellow Time (s)	
All-Red Time (s)	
Lost Time Adjust (s)	
Total Lost Time (s)	
Lead/Lag	
Lead-Lag Optimize?	
Vehicle Extension (s)	
Recall Mode	
Walk Time (s)	
Flash Dont Walk (s)	
Pedestrian Calls (#/hr)	
Act Effect Green (s)	
Actuated g/C Ratio	
v/c Ratio	
Control Delay	
Queue Delay	
Total Delay	
LOS	
Approach Delay	
Approach LOS	
Queue Length 50th (ft)	
Queue Length 95th (ft)	
Internal Link Dist (ft)	
Turn Bay Length (ft)	
Base Capacity (vph)	
Starvation Cap Reductn	
Spillback Cap Reductn	
Storage Cap Reductn	
Reduced v/c Ratio	

Intersection Summary

Area Type: Other  
 Cycle Length: 160  
 Actuated Cycle Length: 160  
 Offset: 86 (54%), Referenced to phase 2:NBSB, Start of Yellow  
 Natural Cycle: 75  
 Control Type: Actuated-Coordinated  
 Maximum v/c Ratio: 0.62  
 Intersection Signal Delay: 5.7 Intersection LOS: A  
 Intersection Capacity Utilization 66.6% ICU Level of Service C  
 Analysis Period (min) 15  
 m Volume for 95th percentile queue is metered by upstream signal.

Splits and Phases: 1369: Preston & Belt Line Village Driveway

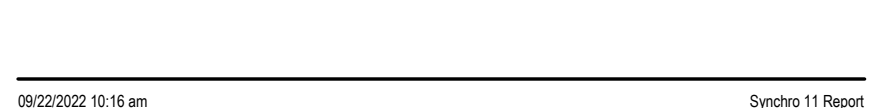

Pepper Square TIA  
Lanes, Volumes, Timings

Phase 1, P, & N - 2033 Background - AM  
1371: Preston & Spring Valley



Lane Group	EBL	EBT	EBR	WBL	WBT	WBR	NBL	NBT	NBR	SBU	SBL	SBT
Lane Configurations	↑↑	↑↑↑		↑↑	↑↑↑		↑↑	↑↑↑			↑↑	↑↑↑
Traffic Volume (vph)	155	375	259	92	755	153	118	1658	78	1	163	2176
Future Volume (vph)	155	375	259	92	755	153	118	1658	78	1	163	2176
Ideal Flow (vphpl)	1900	1900	1900	1900	1900	1900	1900	1900	1900	1900	1900	1900
Storage Length (ft)	225		0	225		0	225		0		275	
Storage Lanes	2		0	2		0	2		0		2	
Taper Length (ft)	25			25			25				25	
Lane Util. Factor	0.97	0.91	0.91	0.97	0.91	0.91	0.97	0.91	0.91	0.91	0.97	0.91
Fr't		0.939			0.975			0.993				0.987
Fit Protected	0.950			0.950			0.950				0.950	
Satd. Flow (prot)	3433	4775	0	3433	4958	0	3433	5050	0	0	3433	5019
Fit Permitted	0.950			0.950			0.950				0.950	
Satd. Flow (perm)	3433	4775	0	3433	4958	0	3433	5050	0	0	3433	5019
Right Turn on Red			Yes			Yes			Yes			
Satd. Flow (RTOR)		103			26			5				15
Link Speed (mph)	38				42			41				38
Link Distance (ft)	3259				5488			2139				1208
Travel Time (s)	58.5				89.1			35.6				21.7
Peak Hour Factor	0.96	0.96	0.96	0.96	0.96	0.96	0.96	0.96	0.96	0.96	0.96	0.96
Adj. Flow (vph)	161	391	270	96	786	159	123	1727	81	1	170	2267
Shared Lane Traffic (%)												
Lane Group Flow (vph)	161	661	0	96	945	0	123	1808	0	0	171	2491
Enter Blocked Intersection	No	No	No	No	No	No	No	No	No	No	No	No
Lane Alignment	Left	Left	Right	Left	Left	Right	Left	Left	Right	R NA	Left	Left
Median Width(ft)	24				24			24				24
Link Offset(ft)	0				0			0				0
Crosswalk Width(ft)	16				16			16				16
Two way Left Turn Lane												
Headway Factor	1.00	1.00	1.00	1.00	1.00	1.00	1.00	1.00	1.00	1.00	1.00	1.00
Turning Speed (mph)	15		9	15		9	15		9	9	15	
Number of Detectors	1	1		1	1		1	1		1	1	1
Detector Template												
Leading Detector (ft)	50	50		50	50		50	50		50	50	50
Trailing Detector (ft)	0	0		0	0		0	0		0	0	0
Detector 1 Position(ft)	0	0		0	0		0	0		0	0	0
Detector 1 Size(ft)	50	50		50	50		50	50		50	50	50
Detector 1 Type	Cl+Ex	Cl+Ex		Cl+Ex	Cl+Ex		Cl+Ex	Cl+Ex		Cl+Ex	Cl+Ex	Cl+Ex
Detector 1 Channel												
Detector 1 Extend (s)	0.0	0.0		0.0	0.0		0.0	0.0		0.0	0.0	0.0
Detector 1 Queue (s)	0.0	0.0		0.0	0.0		0.0	0.0		0.0	0.0	0.0
Detector 1 Delay (s)	0.0	0.0		0.0	0.0		0.0	0.0		0.0	0.0	0.0
Turn Type	Prot	NA		Prot	NA		Prot	NA		Prot	Prot	NA
Protected Phases	3	8		7	4		1	6		5	5	2
Permitted Phases												
Detector Phase	3	8		7	4		1	6		5	5	2
Switch Phase												
Minimum Initial (s)	6.0	12.0		3.0	12.0		3.0	13.0		3.0	3.0	18.0
Minimum Split (s)	11.0	27.5		11.0	27.5		11.0	28.0		11.0	11.0	28.0
Total Split (s)	15.0	43.0		16.0	44.0		13.0	71.0		30.0	30.0	88.0

Pepper Square TIA  
Lanes, Volumes, Timings

Phase 1, P, & N - 2033 Background - AM  
1371: Preston & Spring Valley



Lane Group	SBR
Lane Configurations	↑↑
Traffic Volume (vph)	215
Future Volume (vph)	215
Ideal Flow (vphpl)	1900
Storage Length (ft)	0
Storage Lanes	0
Taper Length (ft)	
Lane Util. Factor	0.91
Fr't	
Fit Protected	
Satd. Flow (prot)	0
Fit Permitted	
Satd. Flow (perm)	0
Right Turn on Red	Yes
Satd. Flow (RTOR)	
Link Speed (mph)	
Link Distance (ft)	
Travel Time (s)	
Peak Hour Factor	0.96
Adj. Flow (vph)	224
Shared Lane Traffic (%)	
Lane Group Flow (vph)	0
Enter Blocked Intersection	No
Lane Alignment	Right
Median Width(ft)	
Link Offset(ft)	
Crosswalk Width(ft)	
Two way Left Turn Lane	
Headway Factor	1.00
Turning Speed (mph)	9
Number of Detectors	
Detector Template	
Leading Detector (ft)	
Trailing Detector (ft)	
Detector 1 Position(ft)	
Detector 1 Size(ft)	
Detector 1 Type	
Detector 1 Channel	
Detector 1 Extend (s)	
Detector 1 Queue (s)	
Detector 1 Delay (s)	
Turn Type	
Protected Phases	
Permitted Phases	
Detector Phase	
Switch Phase	
Minimum Initial (s)	
Minimum Split (s)	
Total Split (s)	

Pepper Square TIA  
Lanes, Volumes, Timings

Phase 1, P, & N - 2033 Background - AM  
1371: Preston & Spring Valley



Lane Group	EBL	EBT	EBR	WBL	WBT	WBR	NBL	NBT	NBR	SBU	SBL	SBT
Total Split (%)	9.4%	26.9%		10.0%	27.5%		8.1%	44.4%		18.8%	18.8%	55.0%
Maximum Green (s)	10.0	37.5		11.0	38.5		8.0	65.0		25.0	25.0	82.0
Yellow Time (s)	3.0	4.0		3.0	4.0		3.0	4.5		3.0	3.0	4.5
All-Red Time (s)	2.0	1.5		2.0	1.5		2.0	1.5		2.0	2.0	1.5
Lost Time Adjust (s)	-1.0	-1.5		-1.0	-1.5		-1.0	-2.0		-1.0	-2.0	
Total Lost Time (s)	4.0	4.0		4.0	4.0		4.0	4.0		4.0	4.0	4.0
Lead/Lag	Lead	Lead		Lag	Lag		Lead	Lead		Lag	Lag	Lag
Lead-Lag Optimize?	Yes	Yes		Yes	Yes		Yes	Yes		Yes	Yes	Yes
Vehicle Extension (s)	0.8	2.0		0.8	2.0		0.8	2.5		0.8	0.8	2.4
Recall Mode	None	None		None	None		None	None		None	None	C-Max
Walk Time (s)		4.0			4.0			4.0				4.0
Flash Dont Walk (s)		18.0			18.0			18.0				18.0
Pedestrian Calls (#/hr)		0			0			0				0
Act Effect Green (s)	10.3	25.1		20.8	35.6		8.9	67.2		30.9	89.1	
Actuated g/C Ratio	0.06	0.16		0.13	0.22		0.06	0.42		0.19	0.56	
v/c Ratio	0.73	0.79		0.22	0.84		0.64	0.85		0.26	0.89	
Control Delay	84.0	59.4		63.5	59.9		92.8	45.4		70.9	47.6	
Queue Delay	0.0	0.0		0.0	0.0		0.0	0.0		0.0	0.0	
Total Delay	84.0	59.4		63.5	59.9		92.8	45.4		70.9	47.6	
LOS	F	E		E	E		F	D		E	D	D
Approach Delay		64.2			60.2			48.4				49.1
Approach LOS		E			E			D				D
Queue Length 50th (ft)	85	224		50	357		68	468		89	958	
Queue Length 95th (ft)	128	262		m47	m332		m105	520		m127	1047	
Internal Link Dist (ft)		3179			5408			2059				1128
Turn Bay Length (ft)	225			225			225			275		
Base Capacity (vph)	236	1241		446	1259		202	2128		662	2803	
Starvation Cap Reductn	0	0		0	0		0	0		0	0	0
Spillback Cap Reductn	0	0		0	0		0	0		0	0	0
Storage Cap Reductn	0	0		0	0		0	0		0	0	0
Reduced v/c Ratio	0.68	0.53		0.22	0.75		0.61	0.85		0.26	0.89	

Intersection Summary

Area Type: Other  
 Cycle Length: 160  
 Actuated Cycle Length: 160  
 Offset: 156 (98%), Referenced to phase 2:SBT, Start of Yellow  
 Natural Cycle: 100  
 Control Type: Actuated-Coordinated  
 Maximum v/c Ratio: 0.89  
 Intersection Signal Delay: 52.6 Intersection LOS: D  
 Intersection Capacity Utilization 86.5% ICU Level of Service E  
 Analysis Period (min) 15  
 m Volume for 95th percentile queue is metered by upstream signal.

Splits and Phases: 1371: Preston & Spring Valley

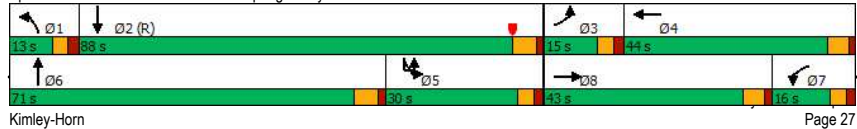

Pepper Square TIA  
Lanes, Volumes, Timings

Phase 1, P, & N - 2033 Background - AM  
1371: Preston & Spring Valley



Lane Group	SBR
Total Split (%)	
Maximum Green (s)	
Yellow Time (s)	
All-Red Time (s)	
Lost Time Adjust (s)	
Total Lost Time (s)	
Lead/Lag	
Lead-Lag Optimize?	
Vehicle Extension (s)	
Recall Mode	
Walk Time (s)	
Flash Dont Walk (s)	
Pedestrian Calls (#/hr)	
Act Effect Green (s)	
Actuated g/C Ratio	
v/c Ratio	
Control Delay	
Queue Delay	
Total Delay	
LOS	
Approach Delay	
Approach LOS	
Queue Length 50th (ft)	
Queue Length 95th (ft)	
Internal Link Dist (ft)	
Turn Bay Length (ft)	
Base Capacity (vph)	
Starvation Cap Reductn	
Spillback Cap Reductn	
Storage Cap Reductn	
Reduced v/c Ratio	

Intersection Summary

Area Type: Other  
 Cycle Length: 160  
 Actuated Cycle Length: 160  
 Offset: 156 (98%), Referenced to phase 2:SBT, Start of Yellow  
 Natural Cycle: 100  
 Control Type: Actuated-Coordinated  
 Maximum v/c Ratio: 0.89  
 Intersection Signal Delay: 52.6 Intersection LOS: D  
 Intersection Capacity Utilization 86.5% ICU Level of Service E  
 Analysis Period (min) 15  
 m Volume for 95th percentile queue is metered by upstream signal.

Pepper Square TIA  
Lanes, Volumes, Timings

Phase 1, P, & N - 2033 Background - AM  
1405: Prestonwood & Belt Line

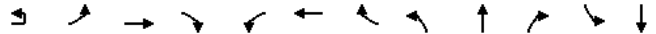

Lane Group	EBU	EBL	EBT	EBR	WBL	WBT	WBR	NBL	NBT	NBR	SBL	SBT
Lane Configurations			↑↑↑		↑↑↑				↑		↑↑↑	↑
Traffic Volume (vph)	4	42	808	3	4	1604	50	1	0	5	40	1
Future Volume (vph)	4	42	808	3	4	1604	50	1	0	5	40	1
Ideal Flow (vphpl)	1900	1900	1900	1900	1900	1900	1900	1900	1900	1900	1900	1900
Storage Length (ft)		200		0	200		0	0		0	300	
Storage Lanes		1		0	1		0	0		0	2	
Taper Length (ft)		25			25			25			25	
Lane Util. Factor	0.91	1.00	0.91	0.91	1.00	0.91	0.91	1.00	1.00	1.00	0.97	0.95
Frt			0.999			0.995			0.887			0.854
Fit Protected		0.950			0.950				0.992		0.950	
Satd. Flow (prot)	0	1770	5080	0	1770	5060	0	0	1639	0	3433	1511
Fit Permitted		0.109			0.315				0.992		0.950	
Satd. Flow (perm)	0	203	5080	0	587	5060	0	0	1639	0	3433	1511
Right Turn on Red			Yes		Yes			Yes				
Satd. Flow (RTOR)			1			6			131			34
Link Speed (mph)			42			42			30			30
Link Distance (ft)			1445			2036			315			868
Travel Time (s)			23.5			33.1			7.2			19.7
Peak Hour Factor	0.95	0.95	0.95	0.95	0.95	0.95	0.95	0.95	0.95	0.95	0.95	0.95
Adj. Flow (vph)	4	44	851	3	4	1688	53	1	0	5	42	1
Shared Lane Traffic (%)												
Lane Group Flow (vph)	0	48	854	0	4	1741	0	0	6	0	42	35
Enter Blocked Intersection	No	No	No	No	No	No	No	No	No	No	No	No
Lane Alignment	R NA	Left	Left	Right	Left	Left	Right	Left	Left	Right	Left	Left
Median Width(ft)			24			24			24			24
Link Offset(ft)			0			0			0			0
Crosswalk Width(ft)			16			16			16			16
Two way Left Turn Lane												
Headway Factor	1.00	1.00	1.00	1.00	1.00	1.00	1.00	1.00	1.00	1.00	1.00	1.00
Turning Speed (mph)	9	15		9	15		9	15		9	15	
Number of Detectors	1	1	1		1	1		1	1		1	1
Detector Template												
Leading Detector (ft)	50	50	50		50	50		50	50		50	50
Trailing Detector (ft)	0	0	0		0	0		0	0		0	0
Detector 1 Position(ft)	0	0	0		0	0		0	0		0	0
Detector 1 Size(ft)	50	50	50		50	50		50	50		50	50
Detector 1 Type	Cl+Ex	Cl+Ex	Cl+Ex		Cl+Ex	Cl+Ex		Cl+Ex	Cl+Ex		Cl+Ex	Cl+Ex
Detector 1 Channel												
Detector 1 Extend (s)	0.0	0.0	0.0		0.0	0.0		0.0	0.0		0.0	0.0
Detector 1 Queue (s)	0.0	0.0	0.0		0.0	0.0		0.0	0.0		0.0	0.0
Detector 1 Delay (s)	0.0	0.0	0.0		0.0	0.0		0.0	0.0		0.0	0.0
Turn Type	custom	D,P+P	NA		D,P+P	NA		Split	NA		Split	NA
Protected Phases		1	6		5	2		3	3		4	4
Permitted Phases		1	2		6							
Detector Phase	1	1	6		5	2		3	3		4	4
Switch Phase												
Minimum Initial (s)	3.0	3.0	15.0		3.0	15.0		5.0	5.0		7.0	7.0
Minimum Split (s)	8.0	8.0	22.0		8.0	24.0		23.0	23.0		23.2	23.2
Total Split (s)	15.0	15.0	109.0		15.0	109.0		18.0	18.0		18.0	18.0

Pepper Square TIA  
Lanes, Volumes, Timings

Phase 1, P, & N - 2033 Background - AM  
1405: Prestonwood & Belt Line



Lane Group	SBR
Lane Configurations	↑
Traffic Volume (vph)	66
Future Volume (vph)	66
Ideal Flow (vphpl)	1900
Storage Length (ft)	0
Storage Lanes	1
Taper Length (ft)	
Lane Util. Factor	0.95
Frt	0.850
Fit Protected	
Satd. Flow (prot)	1504
Fit Permitted	
Satd. Flow (perm)	1504
Right Turn on Red	Yes
Satd. Flow (RTOR)	89
Link Speed (mph)	
Link Distance (ft)	
Travel Time (s)	
Peak Hour Factor	0.95
Adj. Flow (vph)	69
Shared Lane Traffic (%)	49%
Lane Group Flow (vph)	35
Enter Blocked Intersection	No
Lane Alignment	Right
Median Width(ft)	
Link Offset(ft)	
Crosswalk Width(ft)	
Two way Left Turn Lane	
Headway Factor	1.00
Turning Speed (mph)	9
Number of Detectors	1
Detector Template	
Leading Detector (ft)	50
Trailing Detector (ft)	0
Detector 1 Position(ft)	0
Detector 1 Size(ft)	50
Detector 1 Type	Cl+Ex
Detector 1 Channel	
Detector 1 Extend (s)	0.0
Detector 1 Queue (s)	0.0
Detector 1 Delay (s)	0.0
Turn Type	custom
Protected Phases	
Permitted Phases	1 4
Detector Phase	1 4
Switch Phase	
Minimum Initial (s)	
Minimum Split (s)	
Total Split (s)	

Pepper Square TIA  
Lanes, Volumes, Timings

Phase 1, P, & N - 2033 Background - AM  
1405: Prestonwood & Belt Line

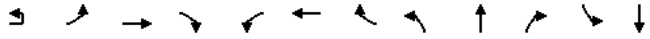

Lane Group	EBU	EBL	EBT	EBR	WBL	WBT	WBR	NBL	NBT	NBR	SBL	SBT
Total Split (%)	9.4%	9.4%	68.1%	9.4%	9.4%	68.1%	11.3%	11.3%	11.3%	11.3%	11.3%	11.3%
Maximum Green (s)	10.0	10.0	103.0	10.0	10.0	103.0	13.0	13.0	12.8	12.8		
Yellow Time (s)	3.0	3.0	4.5	3.0	3.0	4.5	3.0	3.0	3.2	3.2		
All-Red Time (s)	2.0	2.0	1.5	2.0	2.0	1.5	2.0	2.0	2.0	2.0		
Lost Time Adjust (s)		-1.0	-2.0	-1.0	-2.0		-1.0	-2.0	-1.2	-1.2		
Total Lost Time (s)		4.0	4.0	4.0	4.0		4.0	4.0	4.0	4.0		
Lead/Lag	Lag	Lag	Lag	Lead	Lead		Lead	Lead	Lag	Lag		
Lead-Lag Optimize?	Yes	Yes	Yes	Yes	Yes		Yes	Yes	Yes	Yes		
Vehicle Extension (s)	1.0	1.0	2.5	1.0	2.5		1.5	1.5	1.5	1.5		
Recall Mode	None	None	C-Max	None	Max		None	None	None	None		
Walk Time (s)			5.0		4.0		4.0	4.0	4.0	4.0		
Flash Dont Walk (s)			10.0		14.0		14.0	14.0	14.0	14.0		
Pedestrian Calls (#/hr)			0		0		0	0	0	0		
Act Effect Green (s)		141.7	143.1		143.3	132.9		6.0	8.4	8.4		
Actuated g/C Ratio		0.89	0.89		0.90	0.83		0.04	0.05	0.05		
v/c Ratio		0.17	0.19		0.01	0.41		0.03	0.23	0.32		
Control Delay		5.7	1.5		0.8	1.9		0.3	76.0	29.7		
Queue Delay		0.0	0.0		0.0	0.0		0.0	0.0	0.0		
Total Delay		5.7	1.5		0.8	1.9		0.3	76.0	29.7		
LOS		A	A		A	A		A	E	C		
Approach Delay			1.8		1.9			0.3		38.1		
Approach LOS			A		A			A		D		
Queue Length 50th (ft)		3	23		0	62		0	22	1		
Queue Length 95th (ft)		17	65		m1	m85		0	44	42		
Internal Link Dist (ft)			1365		1956			235		788		
Turn Bay Length (ft)		200			200				300			
Base Capacity (vph)		286	4544		609	4202		262	300	163		
Starvation Cap Reductn		0	0		0	0		0	0	0		
Spillback Cap Reductn		0	0		0	0		0	0	0		
Storage Cap Reductn		0	0		0	0		0	0	0		
Reduced v/c Ratio		0.17	0.19		0.01	0.41		0.02	0.14	0.21		

Intersection Summary

Area Type: Other  
 Cycle Length: 160  
 Actuated Cycle Length: 160  
 Offset: 73 (46%), Referenced to phase 6:EBWB, Start of Yellow  
 Natural Cycle: 90  
 Control Type: Actuated-Coordinated  
 Maximum v/c Ratio: 0.41  
 Intersection Signal Delay: 3.3 Intersection LOS: A  
 Intersection Capacity Utilization 55.7% ICU Level of Service B  
 Analysis Period (min) 15  
 m Volume for 95th percentile queue is metered by upstream signal.

Splits and Phases: 1405: Prestonwood & Belt Line

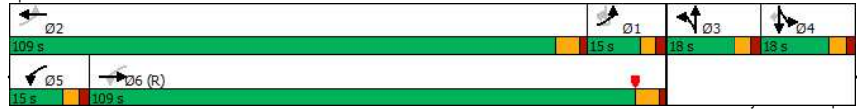

Pepper Square TIA  
Lanes, Volumes, Timings

Phase 1, P, & N - 2033 Background - AM  
1405: Prestonwood & Belt Line



Lane Group	SBR
Total Split (%)	11.3%
Maximum Green (s)	12.8
Yellow Time (s)	3.2
All-Red Time (s)	2.0
Lost Time Adjust (s)	-1.2
Total Lost Time (s)	4.0
Lead/Lag	Lag
Lead-Lag Optimize?	Yes
Vehicle Extension (s)	1.5
Recall Mode	None
Walk Time (s)	4.0
Flash Dont Walk (s)	14.0
Pedestrian Calls (#/hr)	0
Act Effect Green (s)	20.5
Actuated g/C Ratio	0.13
v/c Ratio	0.13
Control Delay	1.0
Queue Delay	0.0
Total Delay	1.0
LOS	A
Approach Delay	
Approach LOS	
Queue Length 50th (ft)	0
Queue Length 95th (ft)	0
Internal Link Dist (ft)	
Turn Bay Length (ft)	
Base Capacity (vph)	338
Starvation Cap Reductn	0
Spillback Cap Reductn	0
Storage Cap Reductn	0
Reduced v/c Ratio	0.10

Intersection Summary

Area Type: Other  
 Cycle Length: 160  
 Actuated Cycle Length: 160  
 Offset: 73 (46%), Referenced to phase 6:EBWB, Start of Yellow  
 Natural Cycle: 90  
 Control Type: Actuated-Coordinated  
 Maximum v/c Ratio: 0.41  
 Intersection Signal Delay: 3.3 Intersection LOS: A  
 Intersection Capacity Utilization 55.7% ICU Level of Service B  
 Analysis Period (min) 15  
 m Volume for 95th percentile queue is metered by upstream signal.

Splits and Phases: 1405: Prestonwood & Belt Line

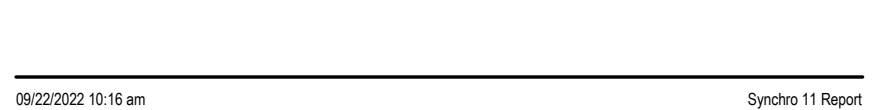



Pepper Square TIA  
HCM 6th TWSC

Phase 1, P, & N - 2033 Background - AM  
2: Ladera Drive & Belt Line

Intersection													
Int Delay, s/veh	34.7												
Movement	EBL	EBT	EBR	WBL	WBT	WBR	NBL	NBT	NBR	SBL	SBT	SBR	
Lane Configurations	↔ ↗ ↘			↔ ↗ ↘			↕ ↗ ↘			↕ ↗ ↘			
Traffic Vol, veh/h	71	769	16	23	1445	43	42	0	67	83	0	151	
Future Vol, veh/h	71	769	16	23	1445	43	42	0	67	83	0	151	
Conflicting Peds, #/hr	0	0	0	0	0	0	0	0	0	0	0	0	
Sign Control	Free	Free	Free	Free	Free	Free	Stop	Stop	Stop	Stop	Stop	Stop	
RT Channelized	-	-	None	-	-	None	-	-	None	-	-	None	
Storage Length	100	-	-	100	-	-	-	-	0	-	-	0	
Veh in Median Storage, #	-	0	-	-	0	-	-	1	-	-	1	-	
Grade, %	-	0	-	-	0	-	-	0	-	-	0	-	
Peak Hour Factor	91	91	91	91	91	91	91	91	91	91	91	91	
Heavy Vehicles, %	2	2	2	2	2	2	2	2	2	2	2	2	
Mvmt Flow	78	845	18	25	1588	47	46	0	74	91	0	166	

Major/Minor	Major1	Major2	Minor1	Minor2								
Conflicting Flow All	1635	0	0	863	0	0	1695	2695	432	2156	2681	818
Stage 1	-	-	-	-	-	-	1010	1010	-	1662	1662	-
Stage 2	-	-	-	-	-	-	685	1685	-	494	1019	-
Critical Hdwy	5.34	-	-	5.34	-	-	6.44	6.54	7.14	6.44	6.54	7.14
Critical Hdwy Stg 1	-	-	-	-	-	-	7.34	5.54	-	7.34	5.54	-
Critical Hdwy Stg 2	-	-	-	-	-	-	6.74	5.54	-	6.74	5.54	-
Follow-up Hdwy	3.12	-	-	3.12	-	-	3.82	4.02	3.92	3.82	4.02	3.92
Pot Cap-1 Maneuver	191	-	-	885	-	-	189	31	*752	*~ 87	32	274
Stage 1	-	-	-	-	-	-	534	577	-	*~ 68	153	-
Stage 2	-	-	-	-	-	-	368	149	-	*771	571	-
Platoon blocked, %	-	-	-	1	-	-	1	1	1	1	1	1
Mov Cap-1 Maneuver	191	-	-	885	-	-	50	18	*752	*~ 52	18	274
Mov Cap-2 Maneuver	-	-	-	-	-	-	57	55	-	*~ 36	99	-
Stage 1	-	-	-	-	-	-	316	342	-	*~ 40	149	-
Stage 2	-	-	-	-	-	-	141	145	-	*412	338	-

Approach	EB	WB	NB	SB
HCM Control Delay, s	3	0.1	76.8	\$ 354.4
HCM LOS			F	F

Minor Lane/Major Mvmt	NBLn1	NBLn2	EBL	EBT	EBR	WBL	WBT	WBR	SBLn1	SBLn2
Capacity (veh/h)	57	752	191	-	-	885	-	-	36	274
HCM Lane V/C Ratio	0.81	0.098	0.408	-	-	0.029	-	-	2.534	0.606
HCM Control Delay (s)	183	10.3	36.3	-	-	9.2	-	-	\$ 932.8	36.4
HCM Lane LOS	F	B	E	-	-	A	-	-	F	E
HCM 95th %tile Q(veh)	3.5	0.3	1.8	-	-	0.1	-	-	10.2	3.6

Notes  
 ~: Volume exceeds capacity    \$: Delay exceeds 300s    +: Computation Not Defined    \*: All major volume in platoon

Pepper Square TIA  
HCM 6th TWSC

Phase 1, P, & N - 2033 Background - AM  
3: Median Opening East of Preston Rd & Belt Line

Intersection													
Int Delay, s/veh	0.3												
Movement	EBU	EBL	EBT	EBR	WBL	WBT	WBR	NBL	NBT	NBR	SBL	SBT	SBR
Lane Configurations	↔ ↗ ↘			↔ ↗ ↘			↕ ↗ ↘			↕ ↗ ↘			
Traffic Vol, veh/h	4	21	582	4	14	1111	18	1	2	0	1	0	3
Future Vol, veh/h	4	21	582	4	14	1111	18	1	2	0	1	0	3
Conflicting Peds, #/hr	0	0	0	0	0	0	0	0	0	0	0	0	0
Sign Control	Free	Free	Free	Free	Free	Free	Stop	Stop	Stop	Stop	Stop	Stop	
RT Channelized	-	-	-	None	-	-	None	-	-	None	-	-	None
Storage Length	-	150	-	-	200	-	-	-	-	-	-	-	-
Veh in Median Storage, #	-	-	0	-	0	-	-	1	-	-	1	-	-
Grade, %	-	-	0	-	0	-	-	0	-	-	0	-	-
Peak Hour Factor	96	96	96	96	96	96	96	96	96	96	96	96	96
Heavy Vehicles, %	2	2	2	2	2	2	2	2	2	2	2	2	2
Mvmt Flow	4	22	606	4	15	1157	19	1	2	0	1	0	3

Major/Minor	Major1	Major2	Minor1	Minor2									
Conflicting Flow All	859	1176	0	0	610	0	0	1153	1866	305	1492	1859	588
Stage 1	-	-	-	-	-	-	-	660	660	-	1197	1197	-
Stage 2	-	-	-	-	-	-	-	493	1206	-	295	662	-
Critical Hdwy	5.64	5.34	-	-	5.34	-	-	6.44	6.54	7.14	6.44	6.54	7.14
Critical Hdwy Stg 1	-	-	-	-	-	-	-	7.34	5.54	-	7.34	5.54	-
Critical Hdwy Stg 2	-	-	-	-	-	-	-	6.74	5.54	-	6.74	5.54	-
Follow-up Hdwy	2.32	3.12	-	-	3.12	-	-	3.82	4.02	3.92	3.82	4.02	3.92
Pot Cap-1 Maneuver	*1134	*843	-	-	601	-	-	*688	*203	589	*420	*206	*671
Stage 1	-	-	-	-	-	-	-	*341	*458	-	*688	*655	-
Stage 2	-	-	-	-	-	-	-	*688	*655	-	*632	*457	-
Platoon blocked, %	1	1	-	-	-	-	-	1	1	1	1	1	1
Mov Cap-1 Maneuver	*879	*879	-	-	601	-	-	*657	*192	589	*401	*194	*671
Mov Cap-2 Maneuver	-	-	-	-	-	-	-	*587	*319	-	*469	*317	-
Stage 1	-	-	-	-	-	-	-	*331	*444	-	*668	*638	-
Stage 2	-	-	-	-	-	-	-	*668	*638	-	*610	*443	-

Approach	EB	WB	NB	SB
HCM Control Delay, s	0.4	0.1	14.7	11
HCM LOS			B	B

Minor Lane/Major Mvmt	NBLn1	EBL	EBT	EBR	WBL	WBT	WBR	SBLn1
Capacity (veh/h)	376	* 879	-	-	601	-	-	606
HCM Lane V/C Ratio	0.008	0.03	-	-	0.024	-	-	0.007
HCM Control Delay (s)	14.7	9.2	-	-	11.1	-	-	11
HCM Lane LOS	B	A	-	-	B	-	-	B
HCM 95th %tile Q(veh)	0	0.1	-	-	0.1	-	-	0

Notes  
 ~: Volume exceeds capacity    \$: Delay exceeds 300s    +: Computation Not Defined    \*: All major volume in platoon

Pepper Square TIA  
HCM 6th TWSC

Phase 1, P, & N - 2033 Background - AM  
5: Belt Line & Median between Berry Trail and Alexis Dr

Intersection												
Int Delay, s/veh	0.2											
Movement	EBL	EBT	EBR	WBL	WBT	WBR	NBL	NBT	NBR	SBL	SBT	SBR
Lane Configurations	↔ ↗ ↘			↔ ↗ ↘			↔			↔		
Traffic Vol, veh/h	5	618	0	12	1107	12	1	0	0	6	1	7
Future Vol, veh/h	5	618	0	12	1107	12	1	0	0	6	1	7
Conflicting Peds, #/hr	0	0	0	0	0	0	0	0	0	0	0	0
Sign Control	Free	Free	Free	Free	Free	Free	Stop	Stop	Stop	Stop	Stop	Stop
RT Channelized	-	-	None	-	-	None	-	-	None	-	-	None
Storage Length	150	-	-	150	-	-	-	-	-	-	-	-
Veh in Median Storage, #	-	0	-	-	0	-	-	1	-	-	1	-
Grade, %	-	0	-	-	0	-	-	0	-	-	0	-
Peak Hour Factor	88	88	88	88	88	88	88	88	88	88	88	88
Heavy Vehicles, %	2	2	2	2	2	2	2	2	2	2	2	2
Mvmt Flow	6	702	0	14	1258	14	1	0	0	7	1	8

Major/Minor	Major1	Major2	Minor1	Minor2
Conflicting Flow All	1272	0	0	702
Stage 1	-	-	-	-
Stage 2	-	-	-	-
Critical Hdwy	5.34	-	-	5.34
Critical Hdwy Stg 1	-	-	-	-
Critical Hdwy Stg 2	-	-	-	-
Follow-up Hdwy	3.12	-	-	3.12
Pot Cap-1 Maneuver	770	-	-	928
Stage 1	-	-	-	-
Stage 2	-	-	-	-
Platoon blocked, %	1	-	-	1
Mov Cap-1 Maneuver	770	-	-	928
Mov Cap-2 Maneuver	-	-	-	-
Stage 1	-	-	-	-
Stage 2	-	-	-	-

Approach	EB	WB	NB	SB
HCM Control Delay, s	0.1	0.1	11.4	11.4
HCM LOS			B	B

Minor Lane/Major Mvmt	NBLn1	EBL	EBT	EBR	WBL	WBT	WBR	SBLn1
Capacity (veh/h)	568	770	-	-	928	-	-	578
HCM Lane V/C Ratio	0.002	0.007	-	-	0.015	-	-	0.028
HCM Control Delay (s)	11.4	9.7	-	-	8.9	-	-	11.4
HCM Lane LOS	B	A	-	-	A	-	-	B
HCM 95th %tile Q(veh)	0	0	-	-	0	-	-	0.1

Notes  
 ~: Volume exceeds capacity    \$: Delay exceeds 300s    +: Computation Not Defined    \*: All major volume in platoon

Pepper Square TIA  
HCM 6th TWSC

Phase 1, P, & N - 2033 Background - AM  
6: Alexis Drive & Belt Line

Intersection						
Int Delay, s/veh	2.4					
Movement	EBT	EBR	WBL	WBT	NBL	NBR
Lane Configurations	↔ ↗		↔ ↗ ↘		↔ ↗	
Traffic Vol, veh/h	617	7	176	1091	24	246
Future Vol, veh/h	617	7	176	1091	24	246
Conflicting Peds, #/hr	0	0	0	0	0	0
Sign Control	Free	Free	Free	Free	Stop	Stop
RT Channelized	-	None	-	None	-	Yield
Storage Length	-	-	150	-	0	0
Veh in Median Storage, #	0	-	-	0	1	-
Grade, %	0	-	-	0	0	-
Peak Hour Factor	86	86	86	86	86	86
Heavy Vehicles, %	2	2	2	2	2	2
Mvmt Flow	717	8	205	1269	28	286

Major/Minor	Major1	Major2	Minor1
Conflicting Flow All	0	0	725
Stage 1	-	-	-
Stage 2	-	-	-
Critical Hdwy	-	-	5.34
Critical Hdwy Stg 1	-	-	-
Critical Hdwy Stg 2	-	-	-
Follow-up Hdwy	-	-	3.12
Pot Cap-1 Maneuver	-	-	902
Stage 1	-	-	-
Stage 2	-	-	-
Platoon blocked, %	-	-	1
Mov Cap-1 Maneuver	-	-	902
Mov Cap-2 Maneuver	-	-	-
Stage 1	-	-	-
Stage 2	-	-	-

Approach	EB	WB	NB
HCM Control Delay, s	0	1.4	12.3
HCM LOS			B

Minor Lane/Major Mvmt	NBLn1	NBLn2	EBT	EBR	WBL	WBT
Capacity (veh/h)	461	784	-	-	902	-
HCM Lane V/C Ratio	0.061	0.365	-	-	0.227	-
HCM Control Delay (s)	13.3	12.2	-	-	10.2	-
HCM Lane LOS	B	B	-	-	B	-
HCM 95th %tile Q(veh)	0.2	1.7	-	-	0.9	-

Notes  
 ~: Volume exceeds capacity    \$: Delay exceeds 300s    +: Computation Not Defined    \*: All major volume in platoon

Pepper Square TIA  
HCM 6th TWSC

Phase 1, P, & N - 2033 Background - AM  
10: Preston & Pepper Square Driveway

Intersection														
Int Delay, s/veh	1.6													
Movement	EBL	EBT	EBR	WBL	WBT	WBR	NBU	NBL	NBT	NBR	SBU	SBL	SBT	SBR
Lane Configurations		↔		↔				↔	↔	↔		↔	↔	↔
Traffic Vol, veh/h	11	3	27	7	1	8	1	53	2041	19	1	16	2154	70
Future Vol, veh/h	11	3	27	7	1	8	1	53	2041	19	1	16	2154	70
Conflicting Peds, #/hr	0	0	0	0	0	0	0	0	0	0	0	0	0	0
Sign Control	Stop	Stop	Stop	Stop	Stop	Free	Free	Free	Free	Free	Free	Free	Free	Free
RT Channelized	-	-	None	-	-	None	-	-	None	-	-	-	-	None
Storage Length	-	-	-	-	-	-	-	150	-	-	-	150	-	-
Veh in Median Storage, #	-	1	-	-	1	-	-	-	0	-	-	-	0	-
Grade, %	-	0	-	-	0	-	-	-	0	-	-	-	0	-
Peak Hour Factor	89	89	89	89	89	89	89	89	89	89	89	89	89	89
Heavy Vehicles, %	2	2	2	2	2	2	2	2	2	2	2	2	2	2
Mvmt Flow	12	3	30	8	1	9	1	60	2293	21	1	18	2420	79

Major/Minor	Minor2	Minor1	Major1	Major2
Conflicting Flow All	3538	4934	1250	3434
Stage 1	2498	2498	-	2426
Stage 2	1040	2436	-	1008
Critical Hdwy	6.44	6.54	7.14	6.44
Critical Hdwy Stg 1	7.34	5.54	-	7.34
Critical Hdwy Stg 2	6.74	5.54	-	6.74
Follow-up Hdwy	3.82	4.02	3.92	3.82
Pot Cap-1 Maneuver	16	0	*428	*22
Stage 1	320	339	-	*19
Stage 2	222	61	-	*439
Platoon blocked, %	1	1	1	1
Mov Cap-1 Maneuver	~11	0	*428	*15
Mov Cap-2 Maneuver	96	27	-	*15
Stage 1	275	267	-	*16
Stage 2	176	52	-	*316

Approach	EB	WB	NB	SB
HCM Control Delay, s	42.1	236.1	0.4	0.4
HCM LOS	E	F		

Minor Lane/Major Mvmt	NBL	NBT	NBR	EBLn1	WBLn1	SBL	SBT	SBR
Capacity (veh/h)	433	-	-	142	30	89	-	-
HCM Lane V/C Ratio	0.14	-	-	0.324	0.599	0.215	-	-
HCM Control Delay (s)	14.7	-	-	42.1	236.1	56.5	-	-
HCM Lane LOS	B	-	-	E	F	F	-	-
HCM 95th %tile Q(veh)	0.5	-	-	1.3	2	0.8	-	-

Notes  
 ~: Volume exceeds capacity    \$: Delay exceeds 300s    +: Computation Not Defined    \*: All major volume in platoon

Pepper Square TIA  
HCM 6th TWSC

Phase 1, P, & N - 2033 Background - AM  
20: Preston & Drive 2

Intersection						
Int Delay, s/veh	0					
Movement	WBL	WBR	NBT	NBR	SBL	SBT
Lane Configurations		↔	↔	↔		↔
Traffic Vol, veh/h	0	2	2025	0	0	2247
Future Vol, veh/h	0	2	2025	0	0	2247
Conflicting Peds, #/hr	0	0	0	0	0	0
Sign Control	Stop	Stop	Free	Free	Free	Free
RT Channelized	-	None	-	None	-	None
Storage Length	-	0	-	-	-	-
Veh in Median Storage, #	0	-	0	-	-	0
Grade, %	0	-	0	-	-	0
Peak Hour Factor	92	92	92	92	92	92
Heavy Vehicles, %	2	2	2	2	2	2
Mvmt Flow	0	2	2201	0	0	2442

Major/Minor	Minor1	Major1	Major2
Conflicting Flow All	-	1101	0
Stage 1	-	-	-
Stage 2	-	-	-
Critical Hdwy	-	7.14	-
Critical Hdwy Stg 1	-	-	-
Critical Hdwy Stg 2	-	-	-
Follow-up Hdwy	-	3.92	-
Pot Cap-1 Maneuver	0	178	-
Stage 1	0	-	-
Stage 2	0	-	-
Platoon blocked, %	-	-	-
Mov Cap-1 Maneuver	-	178	-
Mov Cap-2 Maneuver	-	-	-
Stage 1	-	-	-
Stage 2	-	-	-

Approach	WB	NB	SB
HCM Control Delay, s	25.5	0	0
HCM LOS	D		

Minor Lane/Major Mvmt	NBT	NBR	WBLn1	SBT
Capacity (veh/h)	-	-	178	-
HCM Lane V/C Ratio	-	-	0.012	-
HCM Control Delay (s)	-	-	25.5	-
HCM Lane LOS	-	-	D	-
HCM 95th %tile Q(veh)	-	-	0	-

Pepper Square TIA  
HCM 6th TWSC

Phase 1, P, & N - 2033 Background - AM  
21: Preston & Drive 1

Intersection						
Int Delay, s/veh	0					
Movement	WBL	WBR	NBT	NBR	SBL	SBT
Lane Configurations		↑↑↑	↑↑↑			↑↑↑
Traffic Vol, veh/h	0	0	2115	0	0	2187
Future Vol, veh/h	0	0	2115	0	0	2187
Conflicting Peds, #/hr	0	0	0	0	0	0
Sign Control	Stop	Stop	Free	Free	Free	Free
RT Channelized	-	None	-	None	-	None
Storage Length	-	0	-	-	-	-
Veh in Median Storage, #	0	-	0	-	0	0
Grade, %	0	-	0	-	0	0
Peak Hour Factor	92	92	92	92	92	92
Heavy Vehicles, %	2	2	2	2	2	2
Mvmt Flow	0	0	2299	0	0	2377

Major/Minor	Minor1	Major1	Major2		
Conflicting Flow All	-	1150	0	0	-
Stage 1	-	-	-	-	-
Stage 2	-	-	-	-	-
Critical Hdwy	-	7.14	-	-	-
Critical Hdwy Stg 1	-	-	-	-	-
Critical Hdwy Stg 2	-	-	-	-	-
Follow-up Hdwy	-	3.92	-	-	-
Pot Cap-1 Maneuver	0	165	-	0	-
Stage 1	0	-	-	0	-
Stage 2	0	-	-	0	-
Platoon blocked, %	-	-	-	-	-
Mov Cap-1 Maneuver	-	165	-	-	-
Mov Cap-2 Maneuver	-	-	-	-	-
Stage 1	-	-	-	-	-
Stage 2	-	-	-	-	-

Approach	WB	NB	SB
HCM Control Delay, s	0	0	0
HCM LOS	A		

Minor Lane/Major Mvmt	NBT	NBRWBLn1	SBT
Capacity (veh/h)	-	-	-
HCM Lane V/C Ratio	-	-	-
HCM Control Delay (s)	-	0	-
HCM Lane LOS	-	A	-
HCM 95th %tile Q(veh)	-	-	-

Pepper Square TIA  
HCM 6th TWSC

Phase 1, P, & N - 2033 Background - AM  
22: Drive 6 & Belt Line

Intersection						
Int Delay, s/veh	0					
Movement	EBT	EBR	WBL	WBT	NBL	NBR
Lane Configurations	↑↑↑			↑↑↑		↑
Traffic Vol, veh/h	582	0	0	1150	0	0
Future Vol, veh/h	582	0	0	1150	0	0
Conflicting Peds, #/hr	0	0	0	0	0	0
Sign Control	Free	Free	Free	Free	Stop	Stop
RT Channelized	-	None	-	None	-	None
Storage Length	-	-	-	-	-	0
Veh in Median Storage, #	0	-	-	0	0	-
Grade, %	0	-	-	0	0	-
Peak Hour Factor	96	96	96	96	96	96
Heavy Vehicles, %	2	2	2	2	2	2
Mvmt Flow	606	0	0	1198	0	0

Major/Minor	Major1	Major2	Minor1		
Conflicting Flow All	0	0	-	-	303
Stage 1	-	-	-	-	-
Stage 2	-	-	-	-	-
Critical Hdwy	-	-	-	-	7.14
Critical Hdwy Stg 1	-	-	-	-	-
Critical Hdwy Stg 2	-	-	-	-	-
Follow-up Hdwy	-	-	-	-	3.92
Pot Cap-1 Maneuver	-	0	-	0	591
Stage 1	-	0	-	0	-
Stage 2	-	0	-	0	-
Platoon blocked, %	-	-	-	-	-
Mov Cap-1 Maneuver	-	-	-	-	591
Mov Cap-2 Maneuver	-	-	-	-	-
Stage 1	-	-	-	-	-
Stage 2	-	-	-	-	-

Approach	EB	WB	NB
HCM Control Delay, s	0	0	0
HCM LOS			A

Minor Lane/Major Mvmt	NBLn1	EBT	EBR	WBT
Capacity (veh/h)	-	-	-	-
HCM Lane V/C Ratio	-	-	-	-
HCM Control Delay (s)	0	-	-	-
HCM Lane LOS	A	-	-	-
HCM 95th %tile Q(veh)	-	-	-	-

Pepper Square TIA  
HCM 6th TWSC

Phase 1, P, & N - 2033 Background - AM  
24: Drive 5 & Belt Line

Intersection						
Int Delay, s/veh	0					
Movement	EBT	EBR	WBL	WBT	NBL	NBR
Lane Configurations	↑↑↑			↑↑↑		↑
Traffic Vol, veh/h	612	0	0	1100	0	0
Future Vol, veh/h	612	0	0	1100	0	0
Conflicting Peds, #/hr	0	0	0	0	0	0
Sign Control	Free	Free	Free	Free	Stop	Stop
RT Channelized	-	None	-	None	-	None
Storage Length	-	-	-	-	-	0
Veh in Median Storage, #	0	-	-	0	0	-
Grade, %	0	-	-	0	0	-
Peak Hour Factor	96	96	96	96	96	96
Heavy Vehicles, %	2	2	2	2	2	2
Mvmt Flow	638	0	0	1146	0	0

Major/Minor	Major1	Major2	Minor1
Conflicting Flow All	0	0	- - - 319
Stage 1	-	-	- - -
Stage 2	-	-	- - -
Critical Hdwy	-	-	- - - 7.14
Critical Hdwy Stg 1	-	-	- - -
Critical Hdwy Stg 2	-	-	- - -
Follow-up Hdwy	-	-	- - - 3.92
Pot Cap-1 Maneuver	-	-	0 - 0 577
Stage 1	-	-	0 - 0 -
Stage 2	-	-	0 - 0 -
Platoon blocked, %	-	-	- - -
Mov Cap-1 Maneuver	-	-	- - - 577
Mov Cap-2 Maneuver	-	-	- - -
Stage 1	-	-	- - -
Stage 2	-	-	- - -

Approach	EB	WB	NB
HCM Control Delay, s	0	0	0
HCM LOS			A

Minor Lane/Major Mvmt	NBLn1	EBT	EBR	WBT
Capacity (veh/h)	-	-	-	-
HCM Lane V/C Ratio	-	-	-	-
HCM Control Delay (s)	0	-	-	-
HCM Lane LOS	A	-	-	-
HCM 95th %tile Q(veh)	-	-	-	-

Pepper Square TIA  
HCM 6th TWSC

Phase 1, P, & N - 2033 Background - AM  
25: Preston & Drive 4

Intersection						
Int Delay, s/veh	0					
Movement	WBL	WBR	NBT	NBR	SBL	SBT
Lane Configurations		↑↑↑	↑↑↑			↑↑↑
Traffic Vol, veh/h	0	5	2063	3	0	2247
Future Vol, veh/h	0	5	2063	3	0	2247
Conflicting Peds, #/hr	0	0	0	0	0	0
Sign Control	Stop	Stop	Free	Free	Free	Free
RT Channelized	-	None	-	None	-	None
Storage Length	-	0	-	-	-	-
Veh in Median Storage, #	0	-	0	-	-	0
Grade, %	0	-	0	-	-	0
Peak Hour Factor	92	92	92	92	92	92
Heavy Vehicles, %	2	2	2	2	2	2
Mvmt Flow	0	5	2242	3	0	2442

Major/Minor	Minor1	Major1	Major2
Conflicting Flow All	-	1123	0 0 - -
Stage 1	-	-	- - -
Stage 2	-	-	- - -
Critical Hdwy	-	7.14	- - -
Critical Hdwy Stg 1	-	-	- - -
Critical Hdwy Stg 2	-	-	- - -
Follow-up Hdwy	-	3.92	- - -
Pot Cap-1 Maneuver	0	172	- - 0 -
Stage 1	0	-	- - 0 -
Stage 2	0	-	- - 0 -
Platoon blocked, %	-	-	- - -
Mov Cap-1 Maneuver	-	172	- - -
Mov Cap-2 Maneuver	-	-	- - -
Stage 1	-	-	- - -
Stage 2	-	-	- - -

Approach	WB	NB	SB
HCM Control Delay, s	26.6	0	0
HCM LOS	D		

Minor Lane/Major Mvmt	NBT	NBRWBLn1	SBT
Capacity (veh/h)	-	-	172 -
HCM Lane V/C Ratio	-	-	0.032 -
HCM Control Delay (s)	-	-	26.6 -
HCM Lane LOS	-	-	D -
HCM 95th %tile Q(veh)	-	-	0.1 -

Intersection						
Int Delay, s/veh	0					
Movement	WBL	WBR	NBT	NBR	SBL	SBT
Lane Configurations			↑ ↑ ↑			↑ ↑ ↑
Traffic Vol, veh/h	0	3	2063	0	0	2247
Future Vol, veh/h	0	3	2063	0	0	2247
Conflicting Peds, #/hr	0	0	0	0	0	0
Sign Control	Stop	Stop	Free	Free	Free	Free
RT Channelized	-	None	-	None	-	None
Storage Length	-	0	-	-	-	-
Veh in Median Storage, #	0	-	0	-	-	0
Grade, %	0	-	0	-	-	0
Peak Hour Factor	92	92	92	92	92	92
Heavy Vehicles, %	2	2	2	2	2	2
Mvmt Flow	0	3	2242	0	0	2442

Major/Minor	Minor1	Major1	Major2		
Conflicting Flow All	-	1121	0	0	-
Stage 1	-	-	-	-	-
Stage 2	-	-	-	-	-
Critical Hdwy	-	7.14	-	-	-
Critical Hdwy Stg 1	-	-	-	-	-
Critical Hdwy Stg 2	-	-	-	-	-
Follow-up Hdwy	-	3.92	-	-	-
Pot Cap-1 Maneuver	0	172	-	-	0
Stage 1	0	-	-	-	0
Stage 2	0	-	-	-	0
Platoon blocked, %	-	-	-	-	-
Mov Cap-1 Maneuver	-	172	-	-	-
Mov Cap-2 Maneuver	-	-	-	-	-
Stage 1	-	-	-	-	-
Stage 2	-	-	-	-	-

Approach	WB	NB	SB
HCM Control Delay, s	26.3	0	0
HCM LOS	D		

Minor Lane/Major Mvmt	NBT	NBRWBLn1	SBT
Capacity (veh/h)	-	-	172
HCM Lane V/C Ratio	-	-	0.019
HCM Control Delay (s)	-	-	26.3
HCM Lane LOS	-	-	D
HCM 95th %tile Q(veh)	-	-	0.1

Pepper Square TIA  
Lanes, Volumes, Timings

Phase 1, P, & N - 2033 Background - PM  
4: Berry Trail & Belt Line

Lane Group	EBL	EBT	EBR	WBL	WBT	WBR	NBL	NBT	NBR	SBL	SBT	SBR
Lane Configurations	↔	↕↕↕		↔	↕↕↕		↔	↕		↔	↕	
Traffic Volume (vph)	41	1268	15	19	944	33	3	10	4	28	6	35
Future Volume (vph)	41	1268	15	19	944	33	3	10	4	28	6	35
Ideal Flow (vphpl)	1900	1900	1900	1900	1900	1900	1900	1900	1900	1900	1900	1900
Storage Length (ft)	150		0	150		0	0		0	0		0
Storage Lanes	1		0	1		0	1		0	1		0
Taper Length (ft)	25			25			25			25		
Lane Util. Factor	1.00	0.91	0.91	1.00	0.91	0.91	1.00	1.00	1.00	1.00	1.00	1.00
Frt		0.998			0.995			0.960			0.871	
Fit Protected	0.950			0.950			0.950			0.950		
Satd. Flow (prot)	1770	5075	0	1770	5060	0	1770	1788	0	1770	1622	0
Fit Permitted	0.255			0.176			0.729					
Satd. Flow (perm)	475	5075	0	328	5060	0	1358	1788	0	1863	1622	0
Right Turn on Red		Yes			Yes			Yes			Yes	
Satd. Flow (RTOR)		2			5			4			37	
Link Speed (mph)	42			42			30			30		
Link Distance (ft)	234			493			277			236		
Travel Time (s)	3.8			8.0			6.3			5.4		
Peak Hour Factor	0.94	0.94	0.94	0.94	0.94	0.94	0.94	0.94	0.94	0.94	0.94	0.94
Adj. Flow (vph)	44	1349	16	20	1004	35	3	11	4	30	6	37
Shared Lane Traffic (%)												
Lane Group Flow (vph)	44	1365	0	20	1039	0	3	15	0	30	43	0
Enter Blocked Intersection	No	No	No	No	No	No	No	No	No	No	No	No
Lane Alignment	Left	Left	Right	Left	Left	Right	Left	Left	Right	Left	Left	Right
Median Width(ft)	12			12			12			12		
Link Offset(ft)	0			0			0			0		
Crosswalk Width(ft)	16			16			16			16		
Two way Left Turn Lane												
Headway Factor	1.00	1.00	1.00	1.00	1.00	1.00	1.00	1.00	1.00	1.00	1.00	1.00
Turning Speed (mph)	15		9	15		9	15		9	15		9
Number of Detectors	1	2		1	2		1	2		1	2	
Detector Template	Left	Thru		Left	Thru		Left	Thru		Left	Thru	
Leading Detector (ft)	20	100		20	100		20	100		20	100	
Trailing Detector (ft)	0	0		0	0		0	0		0	0	
Detector 1 Position(ft)	0	0		0	0		0	0		0	0	
Detector 1 Size(ft)	20	6		20	6		20	6		20	6	
Detector 1 Type	CI+Ex	CI+Ex		CI+Ex	CI+Ex		CI+Ex	CI+Ex		CI+Ex	CI+Ex	
Detector 1 Channel												
Detector 1 Extend (s)	0.0	0.0		0.0	0.0		0.0	0.0		0.0	0.0	
Detector 1 Queue (s)	0.0	0.0		0.0	0.0		0.0	0.0		0.0	0.0	
Detector 1 Delay (s)	0.0	0.0		0.0	0.0		0.0	0.0		0.0	0.0	
Detector 2 Position(ft)		94			94			94			94	
Detector 2 Size(ft)		6			6			6			6	
Detector 2 Type		CI+Ex			CI+Ex			CI+Ex			CI+Ex	
Detector 2 Channel												
Detector 2 Extend (s)		0.0			0.0			0.0			0.0	
Turn Type	D,P+P	NA		D,P+P	NA		D,P+P	NA		D,P+P	NA	
Protected Phases	3	8		7	4		1	6		5	2	
Permitted Phases	4			8			2			6		

Pepper Square TIA  
Lanes, Volumes, Timings

Phase 1, P, & N - 2033 Background - PM  
4: Berry Trail & Belt Line

Lane Group	EBL	EBT	EBR	WBL	WBT	WBR	NBL	NBT	NBR	SBL	SBT	SBR
Detector Phase	3	8		7	4		1	6		5	2	
Switch Phase												
Minimum Initial (s)	4.0	4.0		4.0	4.0		4.0	4.0		4.0	4.0	
Minimum Split (s)	10.0	24.0		10.0	24.0		10.0	31.0		10.0	31.0	
Total Split (s)	15.0	99.0		15.0	99.0		15.0	31.0		15.0	31.0	
Total Split (%)	9.4%	61.9%		9.4%	61.9%		9.4%	19.4%		9.4%	19.4%	
Maximum Green (s)	9.0	93.0		9.0	93.0		9.0	25.0		9.0	25.0	
Yellow Time (s)	4.0	4.0		4.0	4.0		4.0	4.0		4.0	4.0	
All-Red Time (s)	2.0	2.0		2.0	2.0		2.0	2.0		2.0	2.0	
Lost Time Adjust (s)	0.0	0.0		0.0	0.0		0.0	0.0		0.0	0.0	
Total Lost Time (s)	6.0	6.0		6.0	6.0		6.0	6.0		6.0	6.0	
Lead/Lag	Lead	Lag		Lead	Lag		Lead	Lag		Lead	Lag	
Lead-Lag Optimize?	Yes	Yes		Yes	Yes		Yes	Yes		Yes	Yes	
Vehicle Extension (s)	1.0	1.0		1.0	1.0		1.0	1.0		1.0	1.0	
Recall Mode	None	C-Max		None	C-Max		None	None		None	None	
Walk Time (s)		4.0			4.0			4.0			4.0	
Flash Dont Walk (s)		14.0			14.0			21.0			21.0	
Pedestrian Calls (#/hr)		0			0			0			0	
Act Effct Green (s)	134.3	134.2		135.5	131.9		9.7	4.9		8.5	8.8	
Actuated g/C Ratio	0.84	0.84		0.85	0.82		0.06	0.03		0.05	0.06	
v/c Ratio	0.10	0.32		0.06	0.25		0.03	0.26		0.32	0.35	
Control Delay	1.9	1.9		1.1	1.2		63.7	71.6		75.4	31.4	
Queue Delay	0.0	0.0		0.0	0.0		0.0	0.0		0.0	0.0	
Total Delay	1.9	1.9		1.1	1.2		63.7	71.6		75.4	31.4	
LOS	A	A		A	A		E	E		E	C	
Approach Delay		1.9			1.2			70.3			49.5	
Approach LOS		A			A			E			D	
Queue Length 50th (ft)	3	42		0	13		3	12		31	6	
Queue Length 95th (ft)	m5	m56		2	55		14	39		63	49	
Internal Link Dist (ft)		154			413			197			156	
Turn Bay Length (ft)	150			150								
Base Capacity (vph)	482	4256		364	4173		133	282		127	284	
Starvation Cap Reductn	0	0		0	0		0	0		0	0	
Spillback Cap Reductn	0	0		0	0		0	0		0	0	
Storage Cap Reductn	0	0		0	0		0	0		0	0	
Reduced v/c Ratio	0.09	0.32		0.05	0.25		0.02	0.05		0.24	0.15	
Intersection Summary												
Area Type:	Other											
Cycle Length:	160											
Actuated Cycle Length:	160											
Offset:	153 (96%), Referenced to phase 4:EBWB and 8:EBWB, Start of Yellow											
Natural Cycle:	75											
Control Type:	Actuated-Coordinated											
Maximum v/c Ratio:	0.35											
Intersection Signal Delay:	3.5						Intersection LOS: A					
Intersection Capacity Utilization:	51.4%						ICU Level of Service A					
Analysis Period (min):	15											
m	Volume for 95th percentile queue is metered by upstream signal.											

Pepper Square TIA  
Lanes, Volumes, Timings

Phase 1, P, & N - 2033 Background - PM  
4: Berry Trail & Belt Line

Splits and Phases: 4: Berry Trail & Belt Line

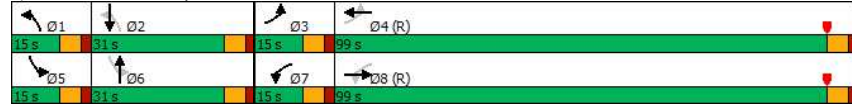

Pepper Square TIA  
Lanes, Volumes, Timings

Phase 1, P, & N - 2033 Background - PM  
1335: Meadow Creek & Belt Line

Lane Group	EBL	EBT	EBR	WBL	WBT	WBR	NBL	NBT	NBR	SBL	SBT	SBR
Lane Configurations												
Traffic Volume (vph)	91	1457	46	7	1195	19	19	12	10	13	5	63
Future Volume (vph)	91	1457	46	7	1195	19	19	12	10	13	5	63
Ideal Flow (vphpl)	1900	1900	1900	1900	1900	1900	1900	1900	1900	1900	1900	1900
Storage Length (ft)	150		0	150		0	0		0	0		0
Storage Lanes	1		0	1		0	0		0	0		0
Taper Length (ft)	25			25			25			25		
Lane Util. Factor	1.00	0.91	0.91	1.00	0.91	0.91	1.00	1.00	1.00	1.00	1.00	1.00
Frt		0.995			0.998			0.966				0.895
Fit Protected	0.950			0.950				0.978				0.992
Satd. Flow (prot)	1770	5060	0	1770	5075	0	0	1760	0	0	1654	0
Fit Permitted	0.202			0.144				0.521				0.936
Satd. Flow (perm)	376	5060	0	268	5075	0	0	937	0	0	1560	0
Right Turn on Red			Yes			Yes			Yes			Yes
Satd. Flow (RTOR)		6			3			11				66
Link Speed (mph)	42			42			30					30
Link Distance (ft)		1673			2404		392					423
Travel Time (s)		27.2			39.0		8.9					9.6
Peak Hour Factor	0.95	0.95	0.95	0.95	0.95	0.95	0.95	0.95	0.95	0.95	0.95	0.95
Adj. Flow (vph)	96	1534	48	7	1258	20	20	13	11	14	5	66
Shared Lane Traffic (%)												
Lane Group Flow (vph)	96	1582	0	7	1278	0	0	44	0	0	85	0
Enter Blocked Intersection	No	No	No	No	No	No	No	No	No	No	No	No
Lane Alignment	Left	Left	Right	Left	Left	Right	Left	Left	Right	Left	Left	Right
Median Width(ft)	12			12			0					0
Link Offset(ft)	0			0			0					0
Crosswalk Width(ft)	16			16			16					16
Two way Left Turn Lane												
Headway Factor	1.00	1.00	1.00	1.00	1.00	1.00	1.00	1.00	1.00	1.00	1.00	1.00
Turning Speed (mph)	15		9	15		9	15		9	15		9
Number of Detectors	1	1		1	1		1	1		1	1	
Detector Template												
Leading Detector (ft)	50	50		50	50		50	50		50	50	
Trailing Detector (ft)	0	0		0	0		0	0		0	0	
Detector 1 Position(ft)	0	0		0	0		0	0		0	0	
Detector 1 Size(ft)	50	50		50	50		50	50		50	50	
Detector 1 Type	Cl+Ex	Cl+Ex		Cl+Ex	Cl+Ex		Cl+Ex	Cl+Ex		Cl+Ex	Cl+Ex	
Detector 1 Channel												
Detector 1 Extend (s)	0.0	0.0		0.0	0.0		0.0	0.0		0.0	0.0	
Detector 1 Queue (s)	0.0	0.0		0.0	0.0		0.0	0.0		0.0	0.0	
Detector 1 Delay (s)	0.0	0.0		0.0	0.0		0.0	0.0		0.0	0.0	
Turn Type	Perm	NA		Perm	NA		Perm	NA		Perm	NA	
Protected Phases		6			2			4			4	
Permitted Phases	6			2			4			4		
Detector Phase	6	6		2	2		4	4		4	4	
Switch Phase												
Minimum Initial (s)	12.0	12.0		12.0	12.0		6.0	6.0		6.0	6.0	
Minimum Split (s)	17.0	17.0		17.0	17.0		23.5	23.5		23.5	23.5	
Total Split (s)	110.0	110.0		110.0	110.0		50.0	50.0		50.0	50.0	



Pepper Square TIA  
Lanes, Volumes, Timings

Phase 1, P, & N - 2033 Background - PM  
1335: Meadow Creek & Belt Line

Lane Group	EBL	EBT	EBR	WBL	WBT	WBR	NBL	NBT	NBR	SBL	SBT	SBR
Total Split (%)	68.8%	68.8%		68.8%	68.8%		31.3%	31.3%		31.3%	31.3%	
Maximum Green (s)	105.0	105.0		105.0	105.0		44.5	44.5		44.5	44.5	
Yellow Time (s)	4.0	4.0		4.0	4.0		3.7	3.7		3.7	3.7	
All-Red Time (s)	1.0	1.0		1.0	1.0		1.8	1.8		1.8	1.8	
Lost Time Adjust (s)	-1.0	-1.0		-1.0	-1.0			-1.5			-1.5	
Total Lost Time (s)	4.0	4.0		4.0	4.0			4.0			4.0	
Lead/Lag												
Lead-Lag Optimize?												
Vehicle Extension (s)	2.0	2.0		2.0	2.0		1.8	1.8		1.8	1.8	
Recall Mode	Min	Min		C-Max	C-Max		None	None		None	None	
Walk Time (s)	4.0	4.0		4.0	4.0		4.0	4.0		4.0	4.0	
Flash Dont Walk (s)	8.0	8.0		8.0	8.0		14.0	14.0		14.0	14.0	
Pedestrian Calls (#/hr)	0	0		0	0		0	0		0	0	
Act Effect Green (s)	142.3	142.3		142.3	142.3			9.7			9.7	
Actuated g/C Ratio	0.89	0.89		0.89	0.89			0.06			0.06	
v/c Ratio	0.29	0.35		0.03	0.28			0.66			0.54	
Control Delay	3.1	1.0		0.1	0.1			98.7			35.7	
Queue Delay	0.0	0.0		0.0	0.0			0.0			0.0	
Total Delay	3.1	1.0		0.1	0.1			98.7			35.7	
LOS	A	A		A	A			F			D	
Approach Delay		1.1			0.1			98.7			35.7	
Approach LOS		A			A			F			D	
Queue Length 50th (ft)	3	19		0	4			34			19	
Queue Length 95th (ft)	20	77		m0	m5			80			77	
Internal Link Dist (ft)		1593			2324			312			343	
Turn Bay Length (ft)	150			150								
Base Capacity (vph)	334	4500		238	4513			277			495	
Starvation Cap Reductn	0	0		0	0			0			0	
Spillback Cap Reductn	0	0		0	0			0			0	
Storage Cap Reductn	0	0		0	0			0			0	
Reduced v/c Ratio	0.29	0.35		0.03	0.28			0.16			0.17	

Intersection Summary

Area Type: Other  
 Cycle Length: 160  
 Actuated Cycle Length: 160  
 Offset: 73 (46%), Referenced to phase 2:WBTL, Start of Yellow  
 Natural Cycle: 60  
 Control Type: Actuated-Coordinated  
 Maximum v/c Ratio: 0.66  
 Intersection Signal Delay: 3.0 Intersection LOS: A  
 Intersection Capacity Utilization 54.5% ICU Level of Service A  
 Analysis Period (min) 15  
 m Volume for 95th percentile queue is metered by upstream signal.

Splits and Phases: 1335: Meadow Creek & Belt Line



Kimley-Horn

Pepper Square TIA  
Lanes, Volumes, Timings

Phase 1, P, & N - 2033 Background - PM  
1365: Preston & Arapaho

Lane Group	EBU	EBL	EBT	EBR	WBL	WBT	WBR	NBU	NBL	NBT	NBR	SBU
Lane Configurations		↔	↔↔		↔	↔↔			↔	↔↔		
Traffic Volume (vph)	1	287	997	227	194	635	155	3	216	1864	221	5
Future Volume (vph)	1	287	997	227	194	635	155	3	216	1864	221	5
Ideal Flow (vphpl)	1900	1900	1900	1900	1900	1900	1900	1900	1900	1900	1900	1900
Storage Length (ft)		150		0	150		0		300		0	
Storage Lanes		2		0	2		0		2		0	
Taper Length (ft)		25			25				25			
Lane Util. Factor	0.91	0.97	0.91	0.91	0.97	0.91	0.91	0.91	0.97	0.91	0.91	0.91
Frt			0.972			0.971					0.984	
Fit Protected		0.950			0.950				0.950			
Satd. Flow (prot)	0	3433	4943	0	3433	4938	0	0	3433	5004	0	0
Fit Permitted		0.950			0.950				0.950			
Satd. Flow (perm)	0	3433	4943	0	3433	4938	0	0	3433	5004	0	0
Right Turn on Red			Yes			Yes				Yes		
Satd. Flow (RTOR)			33			33				17		
Link Speed (mph)			42			42				42		
Link Distance (ft)			1672			1942				3054		
Travel Time (s)			27.1			31.5				49.6		
Peak Hour Factor	0.93	0.93	0.93	0.93	0.93	0.93	0.93	0.93	0.93	0.93	0.93	0.93
Adj. Flow (vph)	1	309	1072	244	209	683	167	3	232	2004	238	5
Shared Lane Traffic (%)												
Lane Group Flow (vph)	0	310	1316	0	209	850	0	0	235	2242	0	0
Enter Blocked Intersection	No	No	No	No	No	No	No	No	No	No	No	No
Lane Alignment	R NA	Left	Right	Left	Left	Right	R NA	Left	Left	Right	R NA	
Median Width(ft)			24			24				24		
Link Offset(ft)			0			0				0		
Crosswalk Width(ft)			16			16				16		
Two way Left Turn Lane												
Headway Factor	1.00	1.00	1.00	1.00	1.00	1.00	1.00	1.00	1.00	1.00	1.00	1.00
Turning Speed (mph)	9	15		9	15		9	15		9	15	9
Number of Detectors	1	1	1		1	1		1	1	1		1
Detector Template												
Leading Detector (ft)	50	50	50		50	50		50	50	50		50
Trailing Detector (ft)	0	0	0		0	0		0	0	0		0
Detector 1 Position(ft)	0	0	0		0	0		0	0	0		0
Detector 1 Size(ft)	50	50	50		50	50		50	50	50		50
Detector 1 Type	Cl+Ex	Cl+Ex	Cl+Ex		Cl+Ex	Cl+Ex		Cl+Ex	Cl+Ex	Cl+Ex		Cl+Ex
Detector 1 Channel												
Detector 1 Extend (s)	0.0	0.0	0.0		0.0	0.0		0.0	0.0	0.0		0.0
Detector 1 Queue (s)	0.0	0.0	0.0		0.0	0.0		0.0	0.0	0.0		0.0
Detector 1 Delay (s)	0.0	0.0	0.0		0.0	0.0		0.0	0.0	0.0		0.0
Turn Type	Prot	Prot	NA		Prot	NA		Prot	Prot	NA		Prot
Protected Phases	3	3	8		7	4		1	1	6		5
Permitted Phases												
Detector Phase	3	3	8		7	4		1	1	6		5
Switch Phase												
Minimum Initial (s)	3.0	3.0	18.0		3.0	18.0		3.0	3.0	18.0		3.0
Minimum Split (s)	10.0	10.0	36.7		21.0	36.3		10.0	10.0	35.7		10.0
Total Split (s)	30.0	30.0	53.0		13.0	36.0		24.0	24.0	76.0		18.0

09/26/2022 4:34 pm  
Kimley-Horn

Pepper Square TIA  
Lanes, Volumes, Timings

Phase 1, P, & N - 2033 Background - PM  
1365: Preston & Arapaho

Lane Group	SBL	SBT	SBR
Lane Configurations	↑↑	↑↑↑	
Traffic Volume (vph)	221	1485	199
Future Volume (vph)	221	1485	199
Ideal Flow (vphpl)	1900	1900	1900
Storage Length (ft)	250		0
Storage Lanes	2		0
Taper Length (ft)	25		
Lane Util. Factor	0.97	0.91	0.91
Frt		0.982	
Fit Protected	0.950		
Satd. Flow (prot)	3433	4994	0
Fit Permitted	0.950		
Satd. Flow (perm)	3433	4994	0
Right Turn on Red			Yes
Satd. Flow (RTOR)		18	
Link Speed (mph)		48	
Link Distance (ft)		5087	
Travel Time (s)		72.3	
Peak Hour Factor	0.93	0.93	0.93
Adj. Flow (vph)	238	1597	214
Shared Lane Traffic (%)			
Lane Group Flow (vph)	243	1811	0
Enter Blocked Intersection	No	No	No
Lane Alignment	Left	Left	Right
Median Width(ft)		24	
Link Offset(ft)		0	
Crosswalk Width(ft)		16	
Two way Left Turn Lane			
Headway Factor	1.00	1.00	1.00
Turning Speed (mph)	15		9
Number of Detectors	1	1	
Detector Template			
Leading Detector (ft)	50	50	
Trailing Detector (ft)	0	0	
Detector 1 Position(ft)	0	0	
Detector 1 Size(ft)	50	50	
Detector 1 Type	CI+Ex	CI+Ex	
Detector 1 Channel			
Detector 1 Extend (s)	0.0	0.0	
Detector 1 Queue (s)	0.0	0.0	
Detector 1 Delay (s)	0.0	0.0	
Turn Type	Prot	NA	
Protected Phases	5	2	
Permitted Phases			
Detector Phase	5	2	
Switch Phase			
Minimum Initial (s)	3.0	18.0	
Minimum Split (s)	10.0	37.7	
Total Split (s)	18.0	70.0	

Pepper Square TIA  
Lanes, Volumes, Timings

Phase 1, P, & N - 2033 Background - PM  
1365: Preston & Arapaho

Lane Group	EBU	EBL	EBT	EBR	WBL	WBT	WBR	NBU	NBL	NBT	NBR	SBU
Total Split (%)	18.8%	18.8%	33.1%		8.1%	22.5%		15.0%	15.0%	47.5%		11.3%
Maximum Green (s)	24.5	24.5	47.7		7.5	30.7		18.5	18.5	70.3		12.5
Yellow Time (s)	3.0	3.0	4.3		3.0	4.3		3.0	3.0	4.7		3.0
All-Red Time (s)	2.5	2.5	1.0		2.5	1.0		2.5	2.5	1.0		2.5
Lost Time Adjust (s)		-1.0	-1.4		-1.0	-1.0			-1.0	-1.7		
Total Lost Time (s)		4.5	3.9		4.5	4.3			4.5	4.0		
Lead/Lag	Lead	Lead	Lead		Lag	Lag		Lead	Lead	Lead		Lag
Lead-Lag Optimize?	Yes	Yes	Yes		Yes	Yes		Yes	Yes	Yes		Yes
Vehicle Extension (s)	0.8	0.8	2.5		0.8	1.8		1.5	1.5	1.7		1.5
Recall Mode	None	None	Max		None	None		None	None	Max		None
Walk Time (s)			4.0			4.0				4.0		
Flash Dont Walk (s)			27.0			27.0				26.0		
Pedestrian Calls (#/hr)			0			0				0		
Act Effect Green (s)		18.7	49.1		8.5	38.5			15.7	72.0		
Actuated g/C Ratio		0.12	0.31		0.05	0.24			0.10	0.45		
v/c Ratio		0.78	0.86		1.15	0.70			0.70	0.99		
Control Delay		81.1	56.6		168.2	52.2			94.5	32.1		
Queue Delay		0.0	0.0		0.0	0.0			0.0	0.0		
Total Delay		81.1	56.6		168.2	52.2			94.5	32.1		
LOS		F	E		F	D			F	C		
Approach Delay			61.3			75.1				38.0		
Approach LOS			E			E				D		
Queue Length 50th (ft)		165	466		-132	259			114	204		
Queue Length 95th (ft)		212	529		#222	235			m121	m#246		
Internal Link Dist (ft)			1592			1862				2974		
Turn Bay Length (ft)		150			150				300			
Base Capacity (vph)		547	1539		182	1213			418	2261		
Starvation Cap Reductn		0	0		0	0			0	0		
Spillback Cap Reductn		0	0		0	0			0	0		
Storage Cap Reductn		0	0		0	0			0	0		
Reduced v/c Ratio		0.57	0.86		1.15	0.70			0.56	0.99		

Intersection Summary

Area Type:	Other
Cycle Length: 160	
Actuated Cycle Length: 160	
Offset: 120 (75%), Referenced to phase 2:SBT, Start of Yellow	
Natural Cycle: 150	
Control Type: Actuated-Coordinated	
Maximum v/c Ratio: 1.15	
Intersection Signal Delay: 50.1	Intersection LOS: D
Intersection Capacity Utilization 91.4%	ICU Level of Service F
Analysis Period (min) 15	
~ Volume exceeds capacity, queue is theoretically infinite. Queue shown is maximum after two cycles.	
# 95th percentile volume exceeds capacity, queue may be longer. Queue shown is maximum after two cycles.	
m Volume for 95th percentile queue is metered by upstream signal.	

Pepper Square TIA  
Lanes, Volumes, Timings

Phase 1, P, & N - 2033 Background - PM  
1365: Preston & Arapaho

Splits and Phases: 1365: Preston & Arapaho

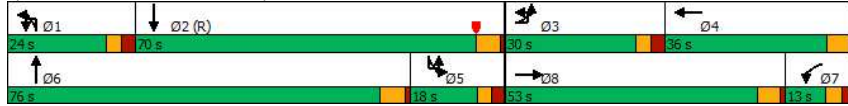

Pepper Square TIA  
Lanes, Volumes, Timings

Phase 1, P, & N - 2033 Background - PM  
1365: Preston & Arapaho

Lane Group	SBL	SBT	SBR
Total Split (%)	11.3%	43.8%	
Maximum Green (s)	12.5	64.3	
Yellow Time (s)	3.0	4.7	
All-Red Time (s)	2.5	1.0	
Lost Time Adjust (s)	-1.0	-1.7	
Total Lost Time (s)	4.5	4.0	
Lead/Lag	Lag	Lag	
Lead-Lag Optimize?	Yes	Yes	
Vehicle Extension (s)	1.5	1.5	
Recall Mode	None	C-Max	
Walk Time (s)		4.0	
Flash Dont Walk (s)		28.0	
Pedestrian Calls (#/hr)		0	
Act Effect Green (s)	13.5	69.8	
Actuated g/C Ratio	0.08	0.44	
v/c Ratio	0.84	0.83	
Control Delay	81.8	37.7	
Queue Delay	0.0	0.0	
Total Delay	81.8	37.7	
LOS	F	D	
Approach Delay		42.9	
Approach LOS		D	
Queue Length 50th (ft)	131	611	
Queue Length 95th (ft)	m158	685	
Internal Link Dist (ft)		5007	
Turn Bay Length (ft)	250		
Base Capacity (vph)	289	2188	
Starvation Cap Reductn	0	0	
Spillback Cap Reductn	0	0	
Storage Cap Reductn	0	0	
Reduced v/c Ratio	0.84	0.83	
<b>Intersection Summary</b>			

Pepper Square TIA  
Lanes, Volumes, Timings

Phase 1, P, & N - 2033 Background - PM  
1367: Preston & Belt Line



Lane Group	EBU	EBL	EBT	EBR	WBU	WBL	WBT	WBR	NBL	NBT	NBR	SBU
Lane Configurations		↔	↕	↔		↔	↕	↔	↔	↕	↔	
Traffic Volume (vph)	47	405	1074	439	1	94	708	133	524	2013	64	2
Future Volume (vph)	47	405	1074	439	1	94	708	133	524	2013	64	2
Ideal Flow (vphpl)	1900	1900	1900	1900	1900	1900	1900	1900	1900	1900	1900	1900
Storage Length (ft)		150		150		200		0	250		0	
Storage Lanes		2		1		1		0	2		0	
Taper Length (ft)		25				25			25			
Lane Util. Factor	0.91	0.97	0.91	1.00	0.91	1.00	0.91	0.91	0.97	0.91	0.91	0.91
Fr			0.850				0.976			0.995		
Fit Protected		0.950				0.950			0.950			
Satd. Flow (prot)	0	3433	5085	1583	0	1770	4963	0	3433	5060	0	0
Fit Permitted		0.950				0.950			0.950			
Satd. Flow (perm)	0	3433	5085	1583	0	1770	4963	0	3433	5060	0	0
Right Turn on Red				Yes			Yes			Yes		
Satd. Flow (RTOR)				246			20			4		
Link Speed (mph)			42				42			42		
Link Distance (ft)			925				394			261		
Travel Time (s)			15.0				6.4			4.2		
Peak Hour Factor	0.96	0.96	0.96	0.96	0.96	0.96	0.96	0.96	0.96	0.96	0.96	0.96
Adj. Flow (vph)	49	422	1119	457	1	98	738	139	546	2097	67	2
Shared Lane Traffic (%)												
Lane Group Flow (vph)	0	471	1119	457	0	99	877	0	546	2164	0	0
Enter Blocked Intersection	No	No	No	No	No	No	No	No	No	No	No	No
Lane Alignment	R NA	Left	Left	Right	R NA	Left	Right	Left	Left	Right	R NA	
Median Width(ft)			24				24			24		
Link Offset(ft)			0				0			0		
Crosswalk Width(ft)			16				16			16		
Two way Left Turn Lane												
Headway Factor	1.00	1.00	1.00	1.00	1.00	1.00	1.00	1.00	1.00	1.00	1.00	1.00
Turning Speed (mph)	9	15		9	9	15		9	15		9	9
Number of Detectors	1	1	1	1	1	1	1	1	1	1	1	1
Detector Template												
Leading Detector (ft)	50	50	50	50	50	50	50		50	50		50
Trailing Detector (ft)	0	0	0	0	0	0	0		0	0		0
Detector 1 Position(ft)	0	0	0	0	0	0	0		0	0		0
Detector 1 Size(ft)	50	50	50	50	50	50	50		50	50		50
Detector 1 Type	Cl+Ex	Cl+Ex	Cl+Ex	Cl+Ex	Cl+Ex	Cl+Ex	Cl+Ex		Cl+Ex	Cl+Ex		Cl+Ex
Detector 1 Channel												
Detector 1 Extend (s)	0.0	0.0	0.0	0.0	0.0	0.0	0.0		0.0	0.0		0.0
Detector 1 Queue (s)	0.0	0.0	0.0	0.0	0.0	0.0	0.0		0.0	0.0		0.0
Detector 1 Delay (s)	0.0	0.0	0.0	0.0	0.0	0.0	0.0		0.0	0.0		0.0
Turn Type	Prot	Prot	NA	Perm	Prot	Prot	NA		Prot	NA		Prot
Protected Phases	3 13	3 13	8		17	17	4		1 11	6		5
Permitted Phases				8								
Detector Phase	3 13	3 13	8	8	17	17	4		1 11	6		5
Switch Phase												
Minimum Initial (s)			18.0	18.0	3.0	3.0	18.0			18.0		3.0
Minimum Split (s)			32.5	32.5	8.0	8.0	32.5			33.0		11.0
Total Split (s)			50.0	50.0	14.0	14.0	27.0			77.0		19.0

Pepper Square TIA  
Lanes, Volumes, Timings

Phase 1, P, & N - 2033 Background - PM  
1367: Preston & Belt Line



Lane Group	SBL	SBT	SBR	Ø1	Ø3	Ø11	Ø13
Lane Configurations	↔	↕	↔				
Traffic Volume (vph)	163	1539	295				
Future Volume (vph)	163	1539	295				
Ideal Flow (vphpl)	1900	1900	1900				
Storage Length (ft)	200		300				
Storage Lanes	1		1				
Taper Length (ft)	25						
Lane Util. Factor	1.00	0.91	1.00				
Fr			0.850				
Fit Protected	0.950						
Satd. Flow (prot)	1770	5085	1583				
Fit Permitted	0.950						
Satd. Flow (perm)	1770	5085	1583				
Right Turn on Red			Yes				
Satd. Flow (RTOR)			235				
Link Speed (mph)			40				
Link Distance (ft)			3054				
Travel Time (s)			52.1				
Peak Hour Factor	0.96	0.96	0.96				
Adj. Flow (vph)	170	1603	307				
Shared Lane Traffic (%)							
Lane Group Flow (vph)	172	1603	307				
Enter Blocked Intersection	No	No	No				
Lane Alignment	Left	Left	Right				
Median Width(ft)			24				
Link Offset(ft)			0				
Crosswalk Width(ft)			16				
Two way Left Turn Lane							
Headway Factor	1.00	1.00	1.00				
Turning Speed (mph)	15		9				
Number of Detectors	1	1	1				
Detector Template							
Leading Detector (ft)	50	50	50				
Trailing Detector (ft)	0	0	0				
Detector 1 Position(ft)	0	0	0				
Detector 1 Size(ft)	50	50	50				
Detector 1 Type	Cl+Ex	Cl+Ex	Cl+Ex				
Detector 1 Channel							
Detector 1 Extend (s)	0.0	0.0	0.0				
Detector 1 Queue (s)	0.0	0.0	0.0				
Detector 1 Delay (s)	0.0	0.0	0.0				
Turn Type	Prot	NA	Perm				
Protected Phases	5	2		1	3	11	13
Permitted Phases			2				
Detector Phase	5	2	2				
Switch Phase							
Minimum Initial (s)	3.0	18.0	18.0	3.0	3.0	3.0	3.0
Minimum Split (s)	11.0	33.0	33.0	8.0	11.0	8.0	11.0
Total Split (s)	19.0	60.0	60.0	16.0	20.0	20.0	17.0

Pepper Square TIA  
Lanes, Volumes, Timings

Phase 1, P, & N - 2033 Background - PM  
1367: Preston & Belt Line

Lane Group	EBU	EBL	EBT	EBR	WBU	WBL	WBT	WBR	NBL	NBT	NBR	SBU
Total Split (%)		31.3%	31.3%	8.8%	8.8%	16.9%			48.1%			11.9%
Maximum Green (s)		44.5	44.5	9.0	9.0	21.5			71.0			14.0
Yellow Time (s)		4.0	4.0	3.0	3.0	4.0			4.4			3.0
All-Red Time (s)		1.5	1.5	2.0	2.0	1.5			1.6			2.0
Lost Time Adjust (s)		-1.5	-1.5		-1.0	-1.5			-1.7			
Total Lost Time (s)		4.0	4.0		4.0	4.0			4.3			
Lead/Lag							Lag		Lag			Lead
Lead-Lag Optimize?							Yes		Yes			Yes
Vehicle Extension (s)		1.3	1.3	3.0	3.0	1.3			2.0			1.5
Recall Mode		Min	Min	None	None	Min			C-Max			None
Walk Time (s)		7.0	7.0			7.0			7.0			
Flash Dont Walk (s)		20.0	20.0			20.0			20.0			
Pedestrian Calls (#/hr)		0	0			0			0			
Act Effect Green (s)	28.0	41.1	41.1		13.9	23.0			29.6			72.7
Actuated g/C Ratio	0.18	0.26	0.26		0.09	0.14			0.18			0.45
v/c Ratio	0.79	0.86	0.78		0.64	1.20			0.86			0.94
Control Delay	62.0	67.6	39.8		65.2	130.2			54.2			28.1
Queue Delay	0.0	0.0	0.0		0.0	0.0			0.0			7.6
Total Delay	62.0	67.6	39.8		65.2	130.2			54.2			35.7
LOS	E	E	D		E	F			D			D
Approach Delay		60.1				123.6			39.5			
Approach LOS		E				F			D			
Queue Length 50th (ft)	200	429	241		109	-386			235			771
Queue Length 95th (ft)	274	473	411		#230	#480			#335			731
Internal Link Dist (ft)		845				314			181			
Turn Bay Length (ft)	150		150		200				250			
Base Capacity (vph)	622	1461	630		154	730			634			2301
Starvation Cap Reductn	0	0	0		0	0			0			140
Spillback Cap Reductn	0	0	0		0	0			0			0
Storage Cap Reductn	0	0	0		0	0			0			0
Reduced v/c Ratio	0.76	0.77	0.73		0.64	1.20			0.86			1.00

Intersection Summary

Area Type:	Other
Cycle Length:	160
Actuated Cycle Length:	160
Offset:	56 (35%), Referenced to phase 6:NBT, Start of Yellow
Natural Cycle:	145
Control Type:	Actuated-Coordinated
Maximum v/c Ratio:	1.20
Intersection Signal Delay:	57.2
Intersection LOS:	E
Intersection Capacity Utilization:	92.6%
ICU Level of Service:	F
Analysis Period (min):	15
~	Volume exceeds capacity, queue is theoretically infinite. Queue shown is maximum after two cycles.
#	95th percentile volume exceeds capacity, queue may be longer. Queue shown is maximum after two cycles.
m	Volume for 95th percentile queue is metered by upstream signal.

Pepper Square TIA  
Lanes, Volumes, Timings

Phase 1, P, & N - 2033 Background - PM  
1367: Preston & Belt Line

Splits and Phases: 1367: Preston & Belt Line



Pepper Square TIA  
Lanes, Volumes, Timings

Phase 1, P, & N - 2033 Background - PM  
1367: Preston & Belt Lane

Lane Group	SBL	SBT	SBR	Ø1	Ø3	Ø11	Ø13
Total Split (%)	11.9%	37.5%	37.5%	10%	13%	13%	11%
Maximum Green (s)	14.0	54.0	54.0	11.0	15.0	15.0	12.0
Yellow Time (s)	3.0	4.4	4.4	3.0	3.0	3.0	3.0
All-Red Time (s)	2.0	1.6	1.6	2.0	2.0	2.0	2.0
Lost Time Adjust (s)	-1.0	-1.7	-1.7				
Total Lost Time (s)	4.0	4.3	4.3				
Lead/Lag	Lead	Lag	Lag	Lead	Lead		
Lead-Lag Optimize?	Yes	Yes	Yes	Yes	Yes		
Vehicle Extension (s)	1.5	2.5	2.5	1.6	1.3	3.0	3.0
Recall Mode	None	Ped	Ped	None	None	None	None
Walk Time (s)		7.0	7.0				
Flash Dont Walk (s)		20.0	20.0				
Pedestrian Calls (#/hr)		0	0				
Act Effect Green (s)	16.0	55.1	55.1				
Actuated g/C Ratio	0.10	0.34	0.34				
v/c Ratio	0.98	0.91	0.44				
Control Delay	103.6	46.9	10.2				
Queue Delay	0.0	0.0	0.0				
Total Delay	103.6	46.9	10.2				
LOS	F	D	B				
Approach Delay		46.2					
Approach LOS		D					
Queue Length 50th (ft)	~189	628	143				
Queue Length 95th (ft)	m#254	m671	m133				
Internal Link Dist (ft)		2974					
Turn Bay Length (ft)	200		300				
Base Capacity (vph)	176	1770	704				
Starvation Cap Reductn	0	0	0				
Spillback Cap Reductn	0	0	0				
Storage Cap Reductn	0	0	0				
Reduced v/c Ratio	0.98	0.91	0.44				

Intersection Summary

Pepper Square TIA  
Lanes, Volumes, Timings

Phase 1, P, & N - 2033 Background - PM  
1368: Preston & Alexis

Lane Group	EBL	EBT	EBR	WBL	WBT	WBR	NBU	NBL	NBT	NBR	SBL	SBT
Lane Configurations	↔	↔	↔	↔	↔	↔	↔	↔	↔	↔	↔	↔
Traffic Volume (vph)	68	24	66	260	24	95	7	45	2472	244	248	1738
Future Volume (vph)	68	24	66	260	24	95	7	45	2472	244	248	1738
Ideal Flow (vphpl)	1900	1900	1900	1900	1900	1900	1900	1900	1900	1900	1900	1900
Storage Length (ft)	0		0	175		0		150		150	150	
Storage Lanes	1		1	2		1		1		1	1	
Taper Length (ft)	25			25				25			25	
Lane Util. Factor	0.91	0.91	1.00	0.97	1.00	1.00	0.91	1.00	0.91	1.00	1.00	0.91
Frt			0.850			0.850				0.850		
Fit Protected	0.950	0.971		0.950				0.950			0.950	
Satd. Flow (prot)	1610	3292	1583	3433	1863	1583	0	1770	5085	1583	1770	5085
Fit Permitted	0.950	0.971		0.950				0.090			0.040	
Satd. Flow (perm)	1610	3292	1583	3433	1863	1583	0	168	5085	1583	75	5085
Right Turn on Red			Yes			Yes				Yes		
Satd. Flow (RTOR)			125			89				96		
Link Speed (mph)		30			30			43				42
Link Distance (ft)		660			627			2867				173
Travel Time (s)		15.0			14.3			45.5				2.8
Peak Hour Factor	0.95	0.95	0.95	0.95	0.95	0.95	0.95	0.95	0.95	0.95	0.95	0.95
Adj. Flow (vph)	72	25	69	274	25	100	7	47	2602	257	261	1829
Shared Lane Traffic (%)	50%											
Lane Group Flow (vph)	36	61	69	274	25	100	0	54	2602	257	261	1829
Enter Blocked Intersection	No	No	No	No	No	No	No	No	No	No	No	No
Lane Alignment	Left	Left	Right	Left	Left	Right	R NA	Left	Left	Right	Left	Left
Median Width(ft)	24			24				12				12
Link Offset(ft)	0			0				0				0
Crosswalk Width(ft)	16			16				16				16
Two way Left Turn Lane												
Headway Factor	1.00	1.00	1.00	1.00	1.00	1.00	1.00	1.00	1.00	1.00	1.00	1.00
Turning Speed (mph)	15		9	15		9	9	15		9	15	
Number of Detectors	1	1	1	1	1	1	1	1	1	1	1	1
Detector Template												
Leading Detector (ft)	50	50	50	50	50	50	50	50	50	50	50	50
Trailing Detector (ft)	0	0	0	0	0	0	0	0	0	0	0	0
Detector 1 Position(ft)	0	0	0	0	0	0	0	0	0	0	0	0
Detector 1 Size(ft)	50	50	50	50	50	50	50	50	50	50	50	50
Detector 1 Type	CI+Ex	CI+Ex	CI+Ex	CI+Ex	CI+Ex	CI+Ex	CI+Ex	CI+Ex	CI+Ex	CI+Ex	CI+Ex	CI+Ex
Detector 1 Channel												
Detector 1 Extend (s)	0.0	0.0	0.0	0.0	0.0	0.0	0.0	0.0	0.0	0.0	0.0	0.0
Detector 1 Queue (s)	0.0	0.0	0.0	0.0	0.0	0.0	0.0	0.0	0.0	0.0	0.0	0.0
Detector 1 Delay (s)	0.0	0.0	0.0	0.0	0.0	0.0	0.0	0.0	0.0	0.0	0.0	0.0
Turn Type	Split	NA	Perm	Split	NA	pm+ov	D,P+P	D,P+P	NA	Perm	D,P+P	NA
Permitted Phases	3	3		4	4	5	1	1	6		5	2
Permitted Phases			3			4	2	2		6		6
Detector Phase	3	3	3	4	4	5	1	1	6	6	5	2
Switch Phase												
Minimum Initial (s)	6.0	6.0	6.0	8.0	8.0	3.0	3.0	3.0	14.0	14.0	3.0	14.0
Minimum Split (s)	27.0	27.0	27.0	27.0	27.0	8.4	8.4	8.4	24.0	24.0	8.4	24.0
Total Split (s)	23.0	23.0	23.0	22.0	22.0	20.0	15.0	15.0	95.0	95.0	20.0	100.0

Pepper Square TIA  
Lanes, Volumes, Timings

Phase 1, P, & N - 2033 Background - PM  
1368: Preston & Alexis

Lane Group	SBR
Left Configurations	↑
Traffic Volume (vph)	23
Future Volume (vph)	23
Ideal Flow (vphpl)	1900
Storage Length (ft)	150
Storage Lanes	1
Taper Length (ft)	
Lane Util. Factor	1.00
Frt	0.850
Fit Protected	
Satd. Flow (prot)	1583
Fit Permitted	
Satd. Flow (perm)	1583
Right Turn on Red	Yes
Satd. Flow (RTOR)	78
Link Speed (mph)	
Link Distance (ft)	
Travel Time (s)	
Peak Hour Factor	0.95
Adj. Flow (vph)	24
Shared Lane Traffic (%)	
Lane Group Flow (vph)	24
Enter Blocked Intersection	No
Lane Alignment	Right
Median Width(ft)	
Link Offset(ft)	
Crosswalk Width(ft)	
Two way Left Turn Lane	
Headway Factor	1.00
Turning Speed (mph)	9
Number of Detectors	1
Detector Template	
Leading Detector (ft)	50
Trailing Detector (ft)	0
Detector 1 Position(ft)	0
Detector 1 Size(ft)	50
Detector 1 Type	CI+Ex
Detector 1 Channel	
Detector 1 Extend (s)	0.0
Detector 1 Queue (s)	0.0
Detector 1 Delay (s)	0.0
Turn Type	Perm
Protected Phases	
Permitted Phases	2
Detector Phase	2
Switch Phase	
Minimum Initial (s)	14.0
Minimum Split (s)	24.0
Total Split (s)	100.0

Pepper Square TIA  
Lanes, Volumes, Timings

Phase 1, P, & N - 2033 Background - PM  
1368: Preston & Alexis

Lane Group	EBL	EBT	EBR	WBL	WBT	WBR	NBU	NBL	NBT	NBR	SBL	SBT
Total Split (%)	14.4%	14.4%	14.4%	13.8%	13.8%	12.5%	9.4%	9.4%	59.4%	59.4%	12.5%	62.5%
Maximum Green (s)	18.0	18.0	18.0	17.0	17.0	15.6	10.6	10.6	89.0	89.0	15.6	94.0
Yellow Time (s)	4.0	4.0	4.0	4.0	4.0	3.4	3.4	3.4	4.5	4.5	3.4	4.5
All-Red Time (s)	1.0	1.0	1.0	1.0	1.0	1.0	1.0	1.0	1.5	1.5	1.0	1.5
Lost Time Adjust (s)	-1.0	-1.0	0.0	-1.0	-1.0	0.0			-1.0	-2.0	0.0	-1.0
Total Lost Time (s)	4.0	4.0	5.0	4.0	4.0	4.4			3.4	4.0	6.0	3.4
Lead/Lag	Lag	Lag	Lag	Lead	Lead	Lag	Lead	Lead	Lead	Lead	Lag	Lag
Lead-Lag Optimize?	Yes	Yes	Yes	Yes	Yes	Yes	Yes	Yes	Yes	Yes	Yes	Yes
Vehicle Extension (s)	2.0	2.0	2.0	2.0	2.0	1.2	1.2	1.2	2.5	2.5	1.2	2.5
Recall Mode	None	None	None	None	None	None	None	None	Max	Max	None	C-Max
Walk Time (s)	4.0	4.0	4.0	4.0	4.0				4.0	4.0		4.0
Flash Dont Walk (s)	18.0	18.0	18.0	18.0	18.0				14.0	14.0		14.0
Pedestrian Calls (#/hr)	0	0	0	0	0				0	0		0
Act Effect Green (s)	9.3	9.3	8.3	16.7	16.7	36.3			119.9	102.0	100.0	119.2
Actuated g/C Ratio	0.06	0.06	0.05	0.10	0.10	0.23			0.75	0.64	0.62	0.74
v/c Ratio	0.39	0.32	0.34	0.77	0.13	0.23			0.29	0.80	0.25	1.13
Control Delay	83.8	76.0	4.7	84.1	65.9	12.9			8.7	21.0	6.9	124.9
Queue Delay	0.0	0.0	0.0	0.0	0.0	0.0			0.0	0.0	0.0	0.0
Total Delay	83.8	76.0	4.7	84.1	65.9	12.9			8.7	21.0	6.9	124.9
LOS	F	E	A	F	E	B			A	C	A	F
Approach Delay		48.0			65.1				19.5			18.3
Approach LOS		D			E				B			B
Queue Length 50th (ft)	40	34	0	144	24	9			11	679	46	-267
Queue Length 95th (ft)	84	61	0	197	57	60			21	865	78	#449
Internal Link Dist (ft)		580			547				2787			93
Turn Bay Length (ft)				175					150		150	
Base Capacity (vph)	191	390	289	386	209	428			244	3240	1025	231
Starvation Cap Reductn	0	0	0	0	0	0			0	0	0	0
Spillback Cap Reductn	0	0	0	0	0	0			0	0	0	0
Storage Cap Reductn	0	0	0	0	0	0			0	0	0	0
Reduced v/c Ratio	0.19	0.16	0.24	0.71	0.12	0.23			0.22	0.80	0.25	1.13

Intersection Summary

Area Type:	Other
Cycle Length:	160
Actuated Cycle Length:	160
Offset:	63 (39%), Referenced to phase 2:NBSB, Start of Yellow
Natural Cycle:	150
Control Type:	Actuated-Coordinated
Maximum v/c Ratio:	1.13
Intersection Signal Delay:	23.2
Intersection LOS:	C
Intersection Capacity Utilization:	85.6%
ICU Level of Service:	E
Analysis Period (min):	15
~	Volume exceeds capacity, queue is theoretically infinite. Queue shown is maximum after two cycles.
#	95th percentile volume exceeds capacity, queue may be longer. Queue shown is maximum after two cycles.
m	Volume for 95th percentile queue is metered by upstream signal.

Pepper Square TIA  
Lanes, Volumes, Timings

Phase 1, P, & N - 2033 Background - PM  
1368: Preston & Alexis

Splits and Phases: 1368: Preston & Alexis



Pepper Square TIA  
Lanes, Volumes, Timings

Phase 1, P, & N - 2033 Background - PM  
1368: Preston & Alexis

Lane Group	SBR
Total Split (%)	62.5%
Maximum Green (s)	94.0
Yellow Time (s)	4.5
All-Red Time (s)	1.5
Lost Time Adjust (s)	0.0
Total Lost Time (s)	6.0
Lead/Lag	Lag
Lead-Lag Optimize?	Yes
Vehicle Extension (s)	2.5
Recall Mode	C-Max
Walk Time (s)	4.0
Flash Dont Walk (s)	14.0
Pedestrian Calls (#/hr)	0
Act Effect Green (s)	112.3
Actuated g/C Ratio	0.70
v/c Ratio	0.02
Control Delay	0.0
Queue Delay	0.0
Total Delay	0.0
LOS	A
Approach Delay	
Approach LOS	
Queue Length 50th (ft)	0
Queue Length 95th (ft)	m0
Internal Link Dist (ft)	
Turn Bay Length (ft)	150
Base Capacity (vph)	1134
Starvation Cap Reductn	0
Spillback Cap Reductn	0
Storage Cap Reductn	0
Reduced v/c Ratio	0.02
Intersection Summary	



Pepper Square TIA  
Lanes, Volumes, Timings

Phase 1, P, & N - 2033 Background - PM  
1369: Preston & Belt Line Village Driveway



Lane Group	EBL	EBT	EBR	WBL	WBT	WBR	NBU	NBL	NBT	NBR	SBU	SBL
Lane Configurations		↑↑			↕			↕	↑↑↑			↕
Traffic Volume (vph)	82	5	55	25	6	19	1	69	2429	13	8	59
Future Volume (vph)	82	5	55	25	6	19	1	69	2429	13	8	59
Ideal Flow (vphpl)	1900	1900	1900	1900	1900	1900	1900	1900	1900	1900	1900	1900
Storage Length (ft)	0	0	0	0	0	0	0	100	0	0	0	100
Storage Lanes	0	0	0	0	0	0	0	1	0	0	0	1
Taper Length (ft)	25			25				25				25
Lane Util. Factor	0.95	0.95	0.95	1.00	1.00	1.00	0.91	1.00	0.91	0.91	0.91	1.00
Frt		0.942			0.948			0.999				
Fit Protected		0.972			0.976			0.950				0.950
Satd. Flow (prot)	0	3241	0	0	1724	0	0	1770	5080	0	0	1770
Fit Permitted		0.760			0.809			0.060				0.035
Satd. Flow (perm)	0	2534	0	0	1429	0	0	112	5080	0	0	65
Right Turn on Red			Yes			Yes				Yes		
Satd. Flow (RTOR)		57			19			1				
Link Speed (mph)		30			30			42				
Link Distance (ft)		303			249			252				
Travel Time (s)		6.9			5.7			4.1				
Peak Hour Factor	0.97	0.97	0.97	0.97	0.97	0.97	0.97	0.97	0.97	0.97	0.97	0.97
Adj. Flow (vph)	85	5	57	26	6	20	1	71	2504	13	8	61
Shared Lane Traffic (%)												
Lane Group Flow (vph)	0	147	0	0	52	0	0	72	2517	0	0	69
Enter Blocked Intersection	No	No	No	No	No	No	No	No	No	No	No	No
Lane Alignment	Left	Left	Right	Left	Left	Right	R NA	Left	Left	Right	R NA	Left
Median Width(ft)		0			0			12				
Link Offset(ft)		0			0			0				
Crosswalk Width(ft)		16			16			16				
Two way Left Turn Lane												
Headway Factor	1.00	1.00	1.00	1.00	1.00	1.00	1.00	1.00	1.00	1.00	1.00	1.00
Turning Speed (mph)	15		9	15		9	9	15		9	9	15
Number of Detectors	1	1		1	1		1	1	1		1	1
Detector Template												
Leading Detector (ft)	50	50		50	50		50	50	50		50	50
Trailing Detector (ft)	0	0		0	0		0	0	0		0	0
Detector 1 Position(ft)	0	0		0	0		0	0	0		0	0
Detector 1 Size(ft)	50	50		50	50		50	50	50		50	50
Detector 1 Type	Cl+Ex	Cl+Ex		Cl+Ex	Cl+Ex		Cl+Ex	Cl+Ex	Cl+Ex		Cl+Ex	Cl+Ex
Detector 1 Channel												
Detector 1 Extend (s)	0.0	0.0		0.0	0.0		0.0	0.0	0.0		0.0	0.0
Detector 1 Queue (s)	0.0	0.0		0.0	0.0		0.0	0.0	0.0		0.0	0.0
Detector 1 Delay (s)	0.0	0.0		0.0	0.0		0.0	0.0	0.0		0.0	0.0
Turn Type	Perm	NA		Perm	NA		custom	D.P+P	NA		custom	D.P+P
Protected Phases		8			4			1	2			5
Permitted Phases	8			4			1	2			5	6
Detector Phase	8	8		4	4		1	1	6		5	5
Switch Phase												
Minimum Initial (s)	20.0	20.0		20.0	20.0		5.0	5.0	20.0		5.0	5.0
Minimum Split (s)	25.0	25.0		25.0	25.0		10.0	10.0	26.0		10.0	10.0
Total Split (s)	47.0	47.0		47.0	47.0		20.0	20.0	98.0		15.0	15.0

Pepper Square TIA  
Lanes, Volumes, Timings

Phase 1, P, & N - 2033 Background - PM  
1369: Preston & Belt Line Village Driveway



Lane Group	SBT	SBR
Lane Configurations	↑↑↑	
Traffic Volume (vph)	2082	27
Future Volume (vph)	2082	27
Ideal Flow (vphpl)	1900	1900
Storage Length (ft)	0	0
Storage Lanes	0	0
Taper Length (ft)		
Lane Util. Factor	0.91	0.91
Frt	0.998	
Fit Protected		
Satd. Flow (prot)	5075	0
Fit Permitted		
Satd. Flow (perm)	5075	0
Right Turn on Red		Yes
Satd. Flow (RTOR)	2	
Link Speed (mph)	38	
Link Distance (ft)	191	
Travel Time (s)	3.4	
Peak Hour Factor	0.97	0.97
Adj. Flow (vph)	2146	28
Shared Lane Traffic (%)		
Lane Group Flow (vph)	2174	0
Enter Blocked Intersection	No	No
Lane Alignment	Left	Right
Median Width(ft)	12	
Link Offset(ft)	0	
Crosswalk Width(ft)	16	
Two way Left Turn Lane		
Headway Factor	1.00	1.00
Turning Speed (mph)		9
Number of Detectors	1	
Detector Template		
Leading Detector (ft)	50	
Trailing Detector (ft)	0	
Detector 1 Position(ft)	0	
Detector 1 Size(ft)	50	
Detector 1 Type	Cl+Ex	
Detector 1 Channel		
Detector 1 Extend (s)	0.0	
Detector 1 Queue (s)	0.0	
Detector 1 Delay (s)	0.0	
Turn Type	NA	
Protected Phases	2	
Permitted Phases		
Detector Phase	2	
Switch Phase		
Minimum Initial (s)	20.0	
Minimum Split (s)	26.0	
Total Split (s)	93.0	

Pepper Square TIA  
Lanes, Volumes, Timings

Phase 1, P, & N - 2033 Background - PM  
1369: Preston & Belt Line Village Driveway

Lane Group	EBL	EBT	EBR	WBL	WBT	WBR	NBU	NBL	NBT	NBR	SBU	SBL
Total Split (%)	29.4%	29.4%		29.4%	29.4%		12.5%	12.5%	61.3%		9.4%	9.4%
Maximum Green (s)	42.3	42.3		42.3	42.3		15.0	15.0	93.7		10.0	10.0
Yellow Time (s)	3.0	3.0		3.0	3.0		3.0	3.0	3.0		3.0	3.0
All-Red Time (s)	1.7	1.7		1.7	1.7		2.0	2.0	1.3		2.0	2.0
Lost Time Adjust (s)		-1.0			-1.0			-1.0	-2.0			-1.0
Total Lost Time (s)		3.7			3.7			4.0	2.3			4.0
Lead/Lag							Lead	Lead	Lead		Lag	Lag
Lead-Lag Optimize?							Yes	Yes	Yes		Yes	Yes
Vehicle Extension (s)	2.0	2.0		2.0	2.0		1.5	1.5	3.0		1.5	1.5
Recall Mode	None	None		None	None		None	None	Max		None	None
Walk Time (s)	5.0	5.0		5.0	5.0				7.0			
Flash Dont Walk (s)	15.0	15.0		15.0	15.0				8.0			
Pedestrian Calls (#/hr)	0	0		0	0				0			
Act Effect Green (s)		21.0			21.0		127.3	118.0				127.3
Actuated g/C Ratio		0.13			0.13		0.80	0.74				0.80
v/c Ratio		0.38			0.25		0.42	0.67				0.41
Control Delay		41.7			45.6		25.3	2.0				34.1
Queue Delay		0.0			0.0		0.0	0.3				0.0
Total Delay		41.7			45.6		25.3	2.3				34.1
LOS		D			D		C	A				C
Approach Delay		41.7			45.6			3.0				
Approach LOS		D			D			A				
Queue Length 50th (ft)		45			31		11	46				32
Queue Length 95th (ft)		84			77		m26	46				m43
Internal Link Dist (ft)		223			169			172				
Turn Bay Length (ft)							100					100
Base Capacity (vph)		727			400		257	3746				168
Starvation Cap Reductn		0			0		0	535				0
Spillback Cap Reductn		2			0		0	441				0
Storage Cap Reductn		0			0		0	0				0
Reduced v/c Ratio		0.20			0.13		0.28	0.78				0.41

Intersection Summary

Area Type: Other  
 Cycle Length: 160  
 Actuated Cycle Length: 160  
 Offset: 86 (54%), Referenced to phase 2:NBSB, Start of Yellow  
 Natural Cycle: 75  
 Control Type: Actuated-Coordinated  
 Maximum v/c Ratio: 0.67  
 Intersection Signal Delay: 5.5 Intersection LOS: A  
 Intersection Capacity Utilization 78.1% ICU Level of Service D  
 Analysis Period (min) 15  
 m Volume for 95th percentile queue is metered by upstream signal.

Splits and Phases: 1369: Preston & Belt Line Village Driveway

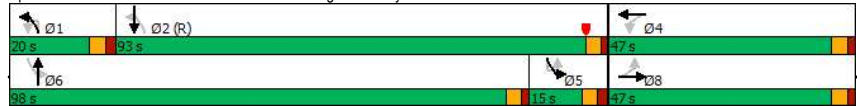

Pepper Square TIA  
Lanes, Volumes, Timings

Phase 1, P, & N - 2033 Background - PM  
1369: Preston & Belt Line Village Driveway

Lane Group	SBT	SBR
Total Split (%)	58.1%	
Maximum Green (s)	88.7	
Yellow Time (s)	3.0	
All-Red Time (s)	1.3	
Lost Time Adjust (s)	-2.0	
Total Lost Time (s)	2.3	
Lead/Lag	Lag	
Lead-Lag Optimize?	Yes	
Vehicle Extension (s)	3.3	
Recall Mode	C-Max	
Walk Time (s)	7.0	
Flash Dont Walk (s)	8.0	
Pedestrian Calls (#/hr)	0	
Act Effect Green (s)	121.0	
Actuated g/C Ratio	0.76	
v/c Ratio	0.57	
Control Delay	3.9	
Queue Delay	0.5	
Total Delay	4.3	
LOS	A	
Approach Delay	5.2	
Approach LOS	A	
Queue Length 50th (ft)	111	
Queue Length 95th (ft)	151	
Internal Link Dist (ft)	111	
Turn Bay Length (ft)		
Base Capacity (vph)	3836	
Starvation Cap Reductn	1020	
Spillback Cap Reductn	0	
Storage Cap Reductn	0	
Reduced v/c Ratio	0.77	

Intersection Summary

Area Type: Other  
 Cycle Length: 160  
 Actuated Cycle Length: 160  
 Offset: 86 (54%), Referenced to phase 2:NBSB, Start of Yellow  
 Natural Cycle: 75  
 Control Type: Actuated-Coordinated  
 Maximum v/c Ratio: 0.67  
 Intersection Signal Delay: 5.5 Intersection LOS: A  
 Intersection Capacity Utilization 78.1% ICU Level of Service D  
 Analysis Period (min) 15  
 m Volume for 95th percentile queue is metered by upstream signal.

Pepper Square TIA  
Lanes, Volumes, Timings

Phase 1, P, & N - 2033 Background - PM  
1371: Preston & Spring Valley

Lane Group	EBL	EBT	EBR	WBL	WBT	WBR	NBU	NBL	NBT	NBR	SBU	SBL
Lane Configurations	↑↑		↑↑↑		↑↑		↑↑↑		↑↑		↑↑	
Traffic Volume (vph)	333	807	230	106	496	174	1	195	2398	203	6	162
Future Volume (vph)	333	807	230	106	496	174	1	195	2398	203	6	162
Ideal Flow (vphpl)	1900	1900	1900	1900	1900	1900	1900	1900	1900	1900	1900	1900
Storage Length (ft)	225			225			225			275		
Storage Lanes	2			0			2			0		
Taper Length (ft)	25			25			25			25		
Lane Util. Factor	0.97	0.91	0.91	0.97	0.91	0.91	0.91	0.97	0.91	0.91	0.91	0.97
Fr	0.967		0.961		0.988							
Fit Protected	0.950			0.950			0.950			0.950		
Satd. Flow (prot)	3433	4917	0	3433	4887	0	0	3433	5024	0	0	3433
Fit Permitted	0.950			0.950			0.950			0.950		
Satd. Flow (perm)	3433	4917	0	3433	4887	0	0	3433	5024	0	0	3433
Right Turn on Red	Yes			Yes			Yes					
Satd. Flow (RTOR)	45			45			12					
Link Speed (mph)	38			42			41					
Link Distance (ft)	3259			5488			2139					
Travel Time (s)	58.5			89.1			35.6					
Peak Hour Factor	0.94	0.94	0.94	0.94	0.94	0.94	0.94	0.94	0.94	0.94	0.94	0.94
Adj. Flow (vph)	354	859	245	113	528	185	1	207	2551	216	6	172
Shared Lane Traffic (%)												
Lane Group Flow (vph)	354	1104	0	113	713	0	0	208	2767	0	0	178
Enter Blocked Intersection	No	No	No	No	No	No	No	No	No	No	No	No
Lane Alignment	Left	Left	Right	Left	Left	Right	R NA	Left	Left	Right	R NA	Left
Median Width(ft)	24			24			24					
Link Offset(ft)	0			0			0					
Crosswalk Width(ft)	16			16			16					
Two way Left Turn Lane												
Headway Factor	1.00	1.00	1.00	1.00	1.00	1.00	1.00	1.00	1.00	1.00	1.00	1.00
Turning Speed (mph)	15		9		15		9		15		9	
Number of Detectors	1	1		1	1		1	1	1		1	1
Detector Template												
Leading Detector (ft)	50	50		50	50		50	50	50		50	50
Trailing Detector (ft)	0	0		0	0		0	0	0		0	0
Detector 1 Position(ft)	0	0		0	0		0	0	0		0	0
Detector 1 Size(ft)	50	50		50	50		50	50	50		50	50
Detector 1 Type	Cl+Ex	Cl+Ex		Cl+Ex	Cl+Ex		Cl+Ex	Cl+Ex	Cl+Ex		Cl+Ex	Cl+Ex
Detector 1 Channel												
Detector 1 Extend (s)	0.0	0.0		0.0	0.0		0.0	0.0	0.0		0.0	0.0
Detector 1 Queue (s)	0.0	0.0		0.0	0.0		0.0	0.0	0.0		0.0	0.0
Detector 1 Delay (s)	0.0	0.0		0.0	0.0		0.0	0.0	0.0		0.0	0.0
Turn Type	Prot	NA		Prot	NA		Prot	Prot	NA		Prot	Prot
Protected Phases	3	8		7	4		1	1	6		5	5
Permitted Phases												
Detector Phase	3	8		7	4		1	1	6		5	5
Switch Phase												
Minimum Initial (s)	6.0	12.0		3.0	12.0		3.0	3.0	13.0		3.0	3.0
Minimum Split (s)	11.0	27.5		11.0	27.5		11.0	11.0	28.0		11.0	11.0
Total Split (s)	40.0	50.0		13.0	23.0		22.0	22.0	82.0		15.0	15.0

Pepper Square TIA  
Lanes, Volumes, Timings

Phase 1, P, & N - 2033 Background - PM  
1371: Preston & Spring Valley

Lane Group	SBT	SBR
Lane Configurations	↑↑↑	
Traffic Volume (vph)	1684	198
Future Volume (vph)	1684	198
Ideal Flow (vphpl)	1900	1900
Storage Length (ft)	0	
Storage Lanes	0	
Taper Length (ft)		
Lane Util. Factor	0.91	0.91
Fr	0.984	
Fit Protected		
Satd. Flow (prot)	5004	0
Fit Permitted		
Satd. Flow (perm)	5004	0
Right Turn on Red	Yes	
Satd. Flow (RTOR)	16	
Link Speed (mph)	38	
Link Distance (ft)	1208	
Travel Time (s)	21.7	
Peak Hour Factor	0.94	0.94
Adj. Flow (vph)	1791	211
Shared Lane Traffic (%)		
Lane Group Flow (vph)	2002	0
Enter Blocked Intersection	No	No
Lane Alignment	Left	Right
Median Width(ft)	24	
Link Offset(ft)	0	
Crosswalk Width(ft)	16	
Two way Left Turn Lane		
Headway Factor	1.00	1.00
Turning Speed (mph)	9	
Number of Detectors	1	
Detector Template		
Leading Detector (ft)	50	
Trailing Detector (ft)	0	
Detector 1 Position(ft)	0	
Detector 1 Size(ft)	50	
Detector 1 Type	Cl+Ex	
Detector 1 Channel		
Detector 1 Extend (s)	0.0	
Detector 1 Queue (s)	0.0	
Detector 1 Delay (s)	0.0	
Turn Type	NA	
Protected Phases	2	
Permitted Phases		
Detector Phase	2	
Switch Phase		
Minimum Initial (s)	18.0	
Minimum Split (s)	28.0	
Total Split (s)	75.0	

Pepper Square TIA  
Lanes, Volumes, Timings

Phase 1, P, & N - 2033 Background - PM  
1371: Preston & Spring Valley

Lane Group	EBL	EBT	EBR	WBL	WBT	WBR	NBU	NBL	NBT	NBR	SBU	SBL
Total Split (%)	25.0%	31.3%	8.1%	14.4%	13.8%	13.8%	51.3%	9.4%	9.4%			
Maximum Green (s)	35.0	44.5	8.0	17.5	17.0	17.0	76.0	10.0	10.0			
Yellow Time (s)	3.0	4.0	3.0	4.0	3.0	3.0	4.5	3.0	3.0			
All-Red Time (s)	2.0	1.5	2.0	1.5	2.0	2.0	1.5	2.0	2.0			
Lost Time Adjust (s)	-1.0	-1.5	-1.0	-1.5	-1.0	-2.0	-1.0	-2.0	-1.0			
Total Lost Time (s)	4.0	4.0	4.0	4.0	4.0	4.0	4.0	4.0	4.0			
Lead/Lag	Lead	Lead	Lag	Lag	Lead	Lead	Lead	Lag	Lag			
Lead-Lag Optimize?	Yes	Yes	Yes	Yes	Yes	Yes	Yes	Yes	Yes			
Vehicle Extension (s)	0.8	2.0	0.8	2.0	0.8	0.8	2.5	0.8	0.8			
Recall Mode	None	Max	None	Max	None	None	None	None	None			
Walk Time (s)		4.0		4.0			4.0					
Flash Dont Walk (s)		18.0		18.0			18.0					
Pedestrian Calls (#/hr)		0		0			0					
Act Effect Green (s)	20.9	46.0	9.0	34.1	13.9	13.9	78.0	11.0	11.0			
Actuated g/C Ratio	0.13	0.29	0.06	0.21	0.09	0.09	0.49	0.07	0.07			
v/c Ratio	0.79	0.76	0.59	0.66	0.70	0.70	1.13	0.75	0.75			
Control Delay	75.5	52.4	71.0	50.9	82.9	82.9	101.9	73.8	73.8			
Queue Delay	0.0	0.0	0.0	0.0	0.0	0.0	0.0	0.0	0.0			
Total Delay	75.5	52.4	71.0	50.9	82.9	82.9	101.9	73.8	73.8			
LOS	E	D	E	D	F	F	F	E	E			
Approach Delay		58.0		53.6			100.6					
Approach LOS		E		D			F					
Queue Length 50th (ft)	184	391	62	239	114	114	~1191	94	94			
Queue Length 95th (ft)	237	436	m59	m246	m158	m158	#1271	m#130	m#130			
Internal Link Dist (ft)		3179		5408			2059					
Turn Bay Length (ft)	225		225		225		225	275	275			
Base Capacity (vph)	772	1445	193	1077	386	386	2455	236	236			
Starvation Cap Reductn	0	0	0	0	0	0	0	0	0			
Spillback Cap Reductn	0	0	0	0	0	0	0	0	0			
Storage Cap Reductn	0	0	0	0	0	0	0	0	0			
Reduced v/c Ratio	0.46	0.76	0.59	0.66	0.54	0.54	1.13	0.75	0.75			

Intersection Summary

Area Type:	Other
Cycle Length:	160
Actuated Cycle Length:	160
Offset:	135 (84%), Referenced to phase 2:SBT, Start of Yellow
Natural Cycle:	130
Control Type:	Actuated-Coordinated
Maximum v/c Ratio:	1.13
Intersection Signal Delay:	66.7
Intersection LOS:	E
Intersection Capacity Utilization:	93.0%
ICU Level of Service:	F
Analysis Period (min):	15
~	Volume exceeds capacity, queue is theoretically infinite. Queue shown is maximum after two cycles.
#	95th percentile volume exceeds capacity, queue may be longer. Queue shown is maximum after two cycles.
m	Volume for 95th percentile queue is metered by upstream signal.

Pepper Square TIA  
Lanes, Volumes, Timings

Phase 1, P, & N - 2033 Background - PM  
1371: Preston & Spring Valley

Splits and Phases: 1371: Preston & Spring Valley

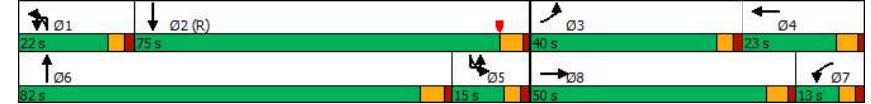

Pepper Square TIA  
Lanes, Volumes, Timings

Phase 1, P, & N - 2033 Background - PM  
1371: Preston & Spring Valley

Lane Group	SBT	SBR
Total Split (%)	46.9%	
Maximum Green (s)	69.0	
Yellow Time (s)	4.5	
All-Red Time (s)	1.5	
Lost Time Adjust (s)	-2.0	
Total Lost Time (s)	4.0	
Lead/Lag	Lag	
Lead-Lag Optimize?	Yes	
Vehicle Extension (s)	2.4	
Recall Mode	C-Max	
Walk Time (s)	4.0	
Flash Dont Walk (s)	18.0	
Pedestrian Calls (#/hr)	0	
Act Effect Green (s)	75.1	
Actuated g/C Ratio	0.47	
v/c Ratio	0.85	
Control Delay	27.5	
Queue Delay	0.0	
Total Delay	27.5	
LOS	C	
Approach Delay	31.3	
Approach LOS	C	
Queue Length 50th (ft)	293	
Queue Length 95th (ft)	654	
Internal Link Dist (ft)	1128	
Turn Bay Length (ft)		
Base Capacity (vph)	2357	
Starvation Cap Reductn	0	
Spillback Cap Reductn	0	
Storage Cap Reductn	0	
Reduced v/c Ratio	0.85	
<b>Intersection Summary</b>		

Pepper Square TIA  
Lanes, Volumes, Timings

Phase 1, P, & N - 2033 Background - PM  
1405: Prestonwood & Belt Line

Lane Group	EBU	EBL	EBT	EBR	WBU	WBL	WBT	WBR	NBL	NBT	NBR	SBL
Lane Configurations		↑↑↑	↑↑↑			↑↑↑	↑↑↑			↑↑		↑↑
Traffic Volume (vph)	7	82	1803	7	3	2	1417	108	6	1	2	155
Future Volume (vph)	7	82	1803	7	3	2	1417	108	6	1	2	155
Ideal Flow (vphpl)	1900	1900	1900	1900	1900	1900	1900	1900	1900	1900	1900	1900
Storage Length (ft)		200		0		200		0	0		0	300
Storage Lanes		1		0		1		0	0		0	2
Taper Length (ft)		25				25		25				25
Lane Util. Factor	0.91	1.00	0.91	0.91	0.91	1.00	0.91	0.91	1.00	1.00	1.00	0.97
Frt			0.999				0.989			0.970		
Fit Protected		0.950				0.950				0.968		0.950
Satd. Flow (prot)	0	1770	5080	0	0	1770	5029	0	0	1749	0	3433
Fit Permitted		0.063				0.090				0.968		0.950
Satd. Flow (perm)	0	117	5080	0	0	168	5029	0	0	1749	0	3433
Right Turn on Red			Yes				Yes			Yes		Yes
Satd. Flow (RTOR)			1				12			2		
Link Speed (mph)			42				42			30		
Link Distance (ft)			1445				2036			315		
Travel Time (s)			23.5				33.1			7.2		
Peak Hour Factor	0.95	0.95	0.95	0.95	0.95	0.95	0.95	0.95	0.95	0.95	0.95	0.95
Adj. Flow (vph)	7	86	1898	7	3	2	1492	114	6	1	2	163
Shared Lane Traffic (%)												
Lane Group Flow (vph)	0	93	1905	0	0	5	1606	0	0	9	0	163
Enter Blocked Intersection	No	No	No	No	No	No	No	No	No	No	No	No
Lane Alignment	R NA	Left	Left	Right	R NA	Left	Left	Right	Left	Left	Right	Left
Median Width(ft)			24				24			24		
Link Offset(ft)			0				0			0		
Crosswalk Width(ft)			16				16			16		
Two way Left Turn Lane												
Headway Factor	1.00	1.00	1.00	1.00	1.00	1.00	1.00	1.00	1.00	1.00	1.00	1.00
Turning Speed (mph)	9	15		9	9	15		9	15		9	15
Number of Detectors	1	1	1		1	1	1		1	1		1
Detector Template												
Leading Detector (ft)	50	50	50		50	50	50		50	50		50
Trailing Detector (ft)	0	0	0		0	0	0		0	0		0
Detector 1 Position(ft)	0	0	0		0	0	0		0	0		0
Detector 1 Size(ft)	50	50	50		50	50	50		50	50		50
Detector 1 Type	CI+Ex	CI+Ex	CI+Ex		CI+Ex	CI+Ex	CI+Ex		CI+Ex	CI+Ex		CI+Ex
Detector 1 Channel												
Detector 1 Extend (s)	0.0	0.0	0.0		0.0	0.0	0.0		0.0	0.0		0.0
Detector 1 Queue (s)	0.0	0.0	0.0		0.0	0.0	0.0		0.0	0.0		0.0
Detector 1 Delay (s)	0.0	0.0	0.0		0.0	0.0	0.0		0.0	0.0		0.0
Turn Type	D,P+P	D,P+P	NA		custom	D,P+P	NA		Split	NA		Split
Protected Phases	1	1	6			5	2		3	3		4
Permitted Phases	2	2			5	6						
Detector Phase	1	1	6		5	5	2		3	3		4
Switch Phase												
Minimum Initial (s)	3.0	3.0	15.0		3.0	3.0	15.0		5.0	5.0		7.0
Minimum Split (s)	8.0	8.0	22.0		8.0	8.0	24.0		23.0	23.0		23.2
Total Split (s)	25.0	25.0	99.0		15.0	15.0	89.0		18.0	18.0		28.0

Pepper Square TIA  
Lanes, Volumes, Timings

Phase 1, P, & N - 2033 Background - PM  
1405: Prestonwood & Belt Line

Lane Group	SBT	SBR
Lane Configurations	↓	↑
Traffic Volume (vph)	2	85
Future Volume (vph)	2	85
Ideal Flow (vphpl)	1900	1900
Storage Length (ft)		0
Storage Lanes		1
Taper Length (ft)		
Lane Util. Factor	0.95	0.95
Frt	0.857	0.850
Fit Protected		
Satd. Flow (prot)	1517	1504
Fit Permitted		
Satd. Flow (perm)	1517	1504
Right Turn on Red		Yes
Satd. Flow (RTOR)	44	89
Link Speed (mph)		30
Link Distance (ft)		868
Travel Time (s)		19.7
Peak Hour Factor	0.95	0.95
Adj. Flow (vph)	2	89
Shared Lane Traffic (%)		49%
Lane Group Flow (vph)	46	45
Enter Blocked Intersection	No	No
Lane Alignment	Left	Right
Median Width(ft)		24
Link Offset(ft)		0
Crosswalk Width(ft)		16
Two way Left Turn Lane		
Headway Factor	1.00	1.00
Turning Speed (mph)		9
Number of Detectors	1	1
Detector Template		
Leading Detector (ft)	50	50
Trailing Detector (ft)	0	0
Detector 1 Position(ft)	0	0
Detector 1 Size(ft)	50	50
Detector 1 Type	CI+Ex	CI+Ex
Detector 1 Channel		
Detector 1 Extend (s)	0.0	0.0
Detector 1 Queue (s)	0.0	0.0
Detector 1 Delay (s)	0.0	0.0
Turn Type	NA	custom
Protected Phases		4
Permitted Phases		1 4
Detector Phase	4	1 4
Switch Phase		
Minimum Initial (s)		7.0
Minimum Split (s)		23.2
Total Split (s)		28.0

Pepper Square TIA  
Lanes, Volumes, Timings

Phase 1, P, & N - 2033 Background - PM  
1405: Prestonwood & Belt Line

Lane Group	EBU	EBL	EBT	EBR	WBU	WBL	WBT	WBR	NBL	NBT	NBR	SBL
Total Split (%)	15.6%	15.6%	61.9%		9.4%	9.4%	55.6%		11.3%	11.3%		17.5%
Maximum Green (s)	20.0	20.0	93.0		10.0	10.0	83.0		13.0	13.0		22.8
Yellow Time (s)	3.0	3.0	4.5		3.0	3.0	4.5		3.0	3.0		3.2
All-Red Time (s)	2.0	2.0	1.5		2.0	2.0	1.5		2.0	2.0		2.0
Lost Time Adjust (s)		-1.0	-2.0			-1.0	-2.0			-1.0		-1.2
Total Lost Time (s)		4.0	4.0			4.0	4.0			4.0		4.0
Lead/Lag	Lag	Lag	Lag		Lead	Lead	Lead		Lead	Lead		Lag
Lead-Lag Optimize?	Yes	Yes	Yes		Yes	Yes	Yes		Yes	Yes		Yes
Vehicle Extension (s)	1.0	1.0	2.5		1.0	1.0	2.5		1.5	1.5		1.5
Recall Mode	None	None	C-Max		None	None	None		None	None		None
Walk Time (s)			5.0				4.0		4.0	4.0		4.0
Flash Dont Walk (s)			10.0				14.0		14.0	14.0		14.0
Pedestrian Calls (#/hr)			0				0		0	0		0
Act Effect Green (s)		131.0	133.3			134.2	77.7			6.3		12.7
Actuated g/C Ratio		0.82	0.83			0.84	0.49			0.04		0.08
v/c Ratio		0.14	0.45			0.03	0.66			0.13		0.60
Control Delay		20.9	5.3			1.0	21.0			67.0		80.2
Queue Delay		0.0	0.0			0.0	0.0			0.0		0.0
Total Delay		20.9	5.3			1.0	21.0			67.0		80.2
LOS		C	A			A	C			E		F
Approach Delay			6.0				20.9			67.0		
Approach LOS			A				C			E		
Queue Length 50th (ft)		13	57			0	255			7		86
Queue Length 95th (ft)		68	454			m1	m305			28		125
Internal Link Dist (ft)			1365				1956			235		
Turn Bay Length (ft)		200				200						300
Base Capacity (vph)		646	4231			251	2677			154		514
Starvation Cap Reductn		0	0			0	0			0		0
Spillback Cap Reductn		0	0			0	0			0		0
Storage Cap Reductn		0	0			0	0			0		0
Reduced v/c Ratio		0.14	0.45			0.02	0.60			0.06		0.32

Intersection Summary

Area Type: Other  
 Cycle Length: 160  
 Actuated Cycle Length: 160  
 Offset: 60 (38%), Referenced to phase 6:EBWB, Start of Yellow  
 Natural Cycle: 90  
 Control Type: Actuated-Coordinated  
 Maximum v/c Ratio: 0.66  
 Intersection Signal Delay: 15.6  
 Intersection LOS: B  
 Intersection Capacity Utilization 55.7%  
 ICU Level of Service B  
 Analysis Period (min) 15  
 m Volume for 95th percentile queue is metered by upstream signal.

Splits and Phases: 1405: Prestonwood & Belt Line



Pepper Square TIA  
Lanes, Volumes, Timings

Phase 1, P, & N - 2033 Background - PM  
1405: Prestonwood & Belt Line



Lane Group	SBT	SBR
Total Split (%)	17.5%	
Maximum Green (s)	22.8	
Yellow Time (s)	3.2	
All-Red Time (s)	2.0	
Lost Time Adjust (s)	-1.2	
Total Lost Time (s)	4.0	
Lead/Lag	Lag	
Lead-Lag Optimize?	Yes	
Vehicle Extension (s)	1.5	
Recall Mode	None	
Walk Time (s)	4.0	
Flash Dont Walk (s)	14.0	
Pedestrian Calls (#/hr)	0	
Act Effect Green (s)	12.7	68.4
Actuated g/C Ratio	0.08	0.43
v/c Ratio	0.29	0.06
Control Delay	23.0	0.2
Queue Delay	0.0	0.0
Total Delay	23.0	0.2
LOS	C	A
Approach Delay	55.6	
Approach LOS	E	
Queue Length 50th (ft)	2	0
Queue Length 95th (ft)	46	0
Internal Link Dist (ft)	788	
Turn Bay Length (ft)		
Base Capacity (vph)	264	794
Starvation Cap Reductn	0	0
Spillback Cap Reductn	0	0
Storage Cap Reductn	0	0
Reduced v/c Ratio	0.17	0.06

Intersection Summary

Pepper Square TIA  
HCM 6th TWSC

Phase 1, P, & N - 2033 Background - PM  
2: Ladera Drive & Belt Line

Intersection												
Int Delay, s/veh	128.2											
Movement	EBL	EBT	EBR	WBL	WBT	WBR	NBL	NBT	NBR	SBL	SBT	SBR
Lane Configurations	↔ ↑↑↑			↔ ↑↑↑			↔ ↑↑			↔ ↑↑		
Traffic Vol, veh/h	183	1775	58	79	1366	129	17	1	50	72	1	119
Future Vol, veh/h	183	1775	58	79	1366	129	17	1	50	72	1	119
Conflicting Peds, #/hr	0	0	0	0	0	0	0	0	0	0	0	0
Sign Control	Free	Free	Free	Free	Free	Stop	Stop	Stop	Stop	Stop	Stop	Stop
RT Channelized	-	-	None	-	-	None	-	-	None	-	-	None
Storage Length	100	-	-	100	-	-	-	-	0	-	-	0
Veh in Median Storage, #	-	0	-	-	0	-	-	1	-	-	1	-
Grade, %	-	0	-	-	0	-	-	0	-	-	0	-
Peak Hour Factor	96	96	96	96	96	96	96	96	96	96	96	96
Heavy Vehicles, %	2	2	2	2	2	2	2	2	2	2	2	2
Mvmt Flow	191	1849	60	82	1423	134	18	1	52	75	1	124

Major/Minor	Major1	Major2	Minor1	Minor2
Conflicting Flow All	1557	0	0	1909
Stage 1	-	-	-	-
Stage 2	-	-	-	-
Critical Hdwy	5.34	-	-	5.34
Critical Hdwy Stg 1	-	-	-	-
Critical Hdwy Stg 2	-	-	-	-
Follow-up Hdwy	3.12	-	-	3.12
Pot Cap-1 Maneuver	209	-	-	*640
Stage 1	-	-	-	-
Stage 2	-	-	-	-
Platoon blocked, %	-	-	-	-
Mov Cap-1 Maneuver	209	-	-	*640
Mov Cap-2 Maneuver	-	-	-	-
Stage 1	-	-	-	-
Stage 2	-	-	-	-

Approach	EB	WB	NB	SB
HCM Control Delay, s	8.1	0.6	40.8	\$2466.3
HCM LOS			E	F

Minor Lane/Major Mvmt	NBLn1	NBLn2	EBL	EBT	EBR	WBL	WBT	WBR	SBLn1	SBLn2
Capacity (veh/h)	49	509	209	-	-	*640	-	-	6	291
HCM Lane V/C Ratio	0.383	0.102	0.912	-	-	0.129	-	-	12.674	0.426
HCM Control Delay (s)	118.3	12.9	88.8	-	-	11.5	-	-	\$6444.1	26.2
HCM Lane LOS	F	B	F	-	-	B	-	-	F	D
HCM 95th %tile Q(veh)	1.4	0.3	7.4	-	-	0.4	-	-	11.3	2

Notes  
 ~: Volume exceeds capacity    \$: Delay exceeds 300s    +: Computation Not Defined    \*: All major volume in platoon

Pepper Square TIA  
HCM 6th TWSC

Phase 1, P, & N - 2033 Background - PM  
3: Median Opening East of Preston Rd & Belt Line

Intersection														
Int Delay, s/veh	0.5													
Movement	EBU	EBL	EBT	EBR	WBU	WBL	WBT	WBR	NBL	NBT	NBR	SBL	SBT	SBR
Lane Configurations	↔ ↑↑↑			↔ ↑↑↑			↔ ↑↑			↔ ↑↑				
Traffic Vol, veh/h	6	6	1278	13	1	14	967	5	2	0	2	21	1	22
Future Vol, veh/h	6	6	1278	13	1	14	967	5	2	0	2	21	1	22
Conflicting Peds, #/hr	0	0	0	0	0	0	0	0	0	0	0	0	0	0
Sign Control	Free	Free	Free	Free	Free	Free	Free	Free	Stop	Stop	Stop	Stop	Stop	Stop
RT Channelized	-	-	-	None	-	-	-	None	-	-	None	-	-	None
Storage Length	-	150	-	-	-	200	-	-	-	-	-	-	-	-
Veh in Median Storage, #	-	-	0	-	-	0	-	-	1	-	-	1	-	-
Grade, %	-	-	0	-	-	0	-	-	0	-	-	0	-	-
Peak Hour Factor	93	93	93	93	93	93	93	93	93	93	93	93	93	93
Heavy Vehicles, %	2	2	2	2	2	2	2	2	2	2	2	2	2	2
Mvmt Flow	6	6	1374	14	1	15	1040	5	2	0	2	23	1	24

Major/Minor	Major1	Major2	Minor1	Minor2
Conflicting Flow All	763	1045	0	0
Stage 1	-	-	-	-
Stage 2	-	-	-	-
Critical Hdwy	5.64	5.34	-	-
Critical Hdwy Stg 1	-	-	-	-
Critical Hdwy Stg 2	-	-	-	-
Follow-up Hdwy	2.32	3.12	-	-
Pot Cap-1 Maneuver	*1189	*884	-	-
Stage 1	-	-	-	-
Stage 2	-	-	-	-
Platoon blocked, %	1	1	-	-
Mov Cap-1 Maneuver	*1000	*1000	-	-
Mov Cap-2 Maneuver	-	-	-	-
Stage 1	-	-	-	-
Stage 2	-	-	-	-

Approach	EB	WB	NB	SB
HCM Control Delay, s	0.1	0.3	32.8	14.3
HCM LOS			D	B

Minor Lane/Major Mvmt	NBLn1	EBL	EBT	EBR	WBL	WBT	WBR	SBLn1
Capacity (veh/h)	134	*1000	-	-	260	-	-	433
HCM Lane V/C Ratio	0.032	0.013	-	-	0.062	-	-	0.109
HCM Control Delay (s)	32.8	8.6	-	-	19.8	-	-	14.3
HCM Lane LOS	D	A	-	-	C	-	-	B
HCM 95th %tile Q(veh)	0.1	0	-	-	0.2	-	-	0.4

Notes  
 ~: Volume exceeds capacity    \$: Delay exceeds 300s    +: Computation Not Defined    \*: All major volume in platoon



Pepper Square TIA  
HCM 6th TWSC

Phase 1, P, & N - 2033 Background - PM  
5: Belt Line & Median between Berry Trail and Alexis Dr

Intersection												
Int Delay, s/veh	0.3											
Movement	EBL	EBT	EBR	WBL	WBT	WBR	NBL	NBT	NBR	SBL	SBT	SBR
Lane Configurations	↔ ↑↑↑			↔ ↑↑↑			↔			↔		
Traffic Vol, veh/h	8	1335	2	28	975	13	3	4	12	4	1	7
Future Vol, veh/h	8	1335	2	28	975	13	3	4	12	4	1	7
Conflicting Peds, #/hr	0	0	0	0	0	0	0	0	0	0	0	0
Sign Control	Free	Free	Free	Free	Free	Stop	Stop	Stop	Stop	Stop	Stop	Stop
RT Channelized	-	-	None	-	-	None	-	-	None	-	-	None
Storage Length	150	-	-	150	-	-	-	-	-	-	-	-
Veh in Median Storage, #	-	0	-	-	0	-	-	1	-	-	1	-
Grade, %	-	0	-	-	0	-	-	0	-	-	0	-
Peak Hour Factor	94	94	94	94	94	94	94	94	94	94	94	94
Heavy Vehicles, %	2	2	2	2	2	2	2	2	2	2	2	2
Mvmt Flow	9	1420	2	30	1037	14	3	4	13	4	1	7

Major/Minor	Major1	Major2	Minor1	Minor2
Conflicting Flow All	1051	0	0	1422
Stage 1	-	-	-	-
Stage 2	-	-	-	-
Critical Hdwy	5.34	-	-	5.34
Critical Hdwy Stg 1	-	-	-	-
Critical Hdwy Stg 2	-	-	-	-
Follow-up Hdwy	3.12	-	-	3.12
Pot Cap-1 Maneuver	883	-	-	*782
Stage 1	-	-	-	-
Stage 2	-	-	-	-
Platoon blocked, %	1	-	-	1
Mov Cap-1 Maneuver	883	-	-	*782
Mov Cap-2 Maneuver	-	-	-	-
Stage 1	-	-	-	-
Stage 2	-	-	-	-

Approach	EB	WB	NB	SB
HCM Control Delay, s	0.1	0.3	12.1	11.5
HCM LOS			B	B

Minor Lane/Major Mvmt	NBLn1	EBL	EBT	EBR	WBL	WBT	WBR	SBLn1
Capacity (veh/h)	526	883	-	-	*782	-	-	569
HCM Lane V/C Ratio	0.038	0.01	-	-	0.038	-	-	0.022
HCM Control Delay (s)	12.1	9.1	-	-	9.8	-	-	11.5
HCM Lane LOS	B	A	-	-	A	-	-	B
HCM 95th %tile Q(veh)	0.1	0	-	-	0.1	-	-	0.1

Notes  
 ~: Volume exceeds capacity    \$: Delay exceeds 300s    +: Computation Not Defined    \*: All major volume in platoon

Pepper Square TIA  
HCM 6th TWSC

Phase 1, P, & N - 2033 Background - PM  
6: Alexis Drive & Belt Line

Intersection						
Int Delay, s/veh	3.5					
Movement	EBT	EBR	WBL	WBT	NBL	NBR
Lane Configurations	↑↑↑		↔ ↑↑↑		↔	
Traffic Vol, veh/h	1308	29	305	999	7	342
Future Vol, veh/h	1308	29	305	999	7	342
Conflicting Peds, #/hr	0	0	0	0	0	0
Sign Control	Free	Free	Free	Free	Stop	Stop
RT Channelized	-	None	-	None	-	Yield
Storage Length	-	-	150	-	0	0
Veh in Median Storage, #	0	-	-	0	1	-
Grade, %	0	-	-	0	0	-
Peak Hour Factor	95	95	95	95	95	95
Heavy Vehicles, %	2	2	2	2	2	2
Mvmt Flow	1377	31	321	1052	7	360

Major/Minor	Major1	Major2	Minor1
Conflicting Flow All	0	0	1408
Stage 1	-	-	-
Stage 2	-	-	-
Critical Hdwy	-	-	5.34
Critical Hdwy Stg 1	-	-	-
Critical Hdwy Stg 2	-	-	-
Follow-up Hdwy	-	-	3.12
Pot Cap-1 Maneuver	-	-	*782
Stage 1	-	-	-
Stage 2	-	-	-
Platoon blocked, %	-	-	1
Mov Cap-1 Maneuver	-	-	*782
Mov Cap-2 Maneuver	-	-	-
Stage 1	-	-	-
Stage 2	-	-	-

Approach	EB	WB	NB
HCM Control Delay, s	0	3	18.4
HCM LOS			C

Minor Lane/Major Mvmt	NBLn1	NBLn2	EBT	EBR	WBL	WBT
Capacity (veh/h)	334	622	-	-	*782	-
HCM Lane V/C Ratio	0.022	0.579	-	-	0.411	-
HCM Control Delay (s)	16	18.4	-	-	12.8	-
HCM Lane LOS	C	C	-	-	B	-
HCM 95th %tile Q(veh)	0.1	3.7	-	-	2	-

Notes  
 ~: Volume exceeds capacity    \$: Delay exceeds 300s    +: Computation Not Defined    \*: All major volume in platoon

Pepper Square TIA  
HCM 6th TWSC

Phase 1, P, & N - 2033 Background - PM  
10: Preston & Pepper Square Driveway

Intersection													
Int Delay, s/veh	30.9												
Movement	EBL	EBT	EBR	WBL	WBT	WBR	NBL	NBT	NBR	SBL	SBT	SBR	
Lane Configurations		↔		↔			↔	↔	↔	↔	↔	↔	
Traffic Vol, veh/h	12	5	63	10	2	55	4	98	2463	35	6	24	1987
Future Vol, veh/h	12	5	63	10	2	55	4	98	2463	35	6	24	1987
Conflicting Peds, #/hr	0	0	0	0	0	0	0	0	0	0	0	0	0
Sign Control	Stop	Stop	Stop	Stop	Stop	Free	Free	Free	Free	Free	Free	Free	Free
RT Channelized	-	-	None	-	-	None	-	-	None	-	-	-	None
Storage Length	-	-	-	-	-	-	150	-	-	150	-	-	-
Veh in Median Storage, #	-	1	-	-	1	-	-	0	-	-	0	-	-
Grade, %	-	0	-	-	0	-	-	0	-	-	0	-	-
Peak Hour Factor	97	97	97	97	97	97	97	97	97	97	97	97	97
Heavy Vehicles, %	2	2	2	2	2	2	2	2	2	2	2	2	2
Mvmt Flow	12	5	65	10	2	57	4	101	2539	36	6	25	2048

Major/Minor	Minor2	Minor1	Major1	Major2									
Conflicting Flow All	3374	4932	1061	3651	4950	1288	1549	2121	0	0	1880	2575	0
Stage 1	2147	2147	-	2767	2767	-	-	-	-	-	-	-	-
Stage 2	1227	2785	-	884	2183	-	-	-	-	-	-	-	-
Critical Hdwy	6.44	6.54	7.14	6.44	6.54	7.14	5.64	5.34	-	5.64	5.34	-	-
Critical Hdwy Stg 1	7.34	5.54	-	7.34	5.54	-	-	-	-	-	-	-	-
Critical Hdwy Stg 2	6.74	5.54	-	6.74	5.54	-	-	-	-	-	-	-	-
Follow-up Hdwy	3.82	4.02	3.92	3.82	4.02	3.92	2.32	3.12	-	2.32	3.12	-	-
Pot Cap-1 Maneuver	*22	*0	*460	*~10	*0	133	*778	*579	-	141	63	-	-
Stage 1	*472	*449	-	*~10	*41	-	-	-	-	-	-	-	-
Stage 2	*169	*40	-	*472	*449	-	-	-	-	-	-	-	-
Platoon blocked, %	1	1	1	1	1	1	1	1	-	-	-	-	-
Mov Cap-1 Maneuver	*~7	*0	*460	*~5	*0	133	*582	*582	-	66	66	-	-
Mov Cap-2 Maneuver	*37	*~2	-	*~7	*25	-	-	-	-	-	-	-	-
Stage 1	*387	*239	-	*~8	*34	-	-	-	-	-	-	-	-
Stage 2	*75	*33	-	*211	*239	-	-	-	-	-	-	-	-

Approach	EB	WB	NB	SB
HCM Control Delay, s	1230.7	700.2	0.5	1.4
HCM LOS	F	F		

Minor Lane/Major Mvmt	NBL	NBT	NBR	EBLn1	WBLn1	SBL	SBT	SBR
Capacity (veh/h)	*582	-	-	27	35	66	-	-
HCM Lane V/C Ratio	0.181	-	-	3.055	1.973	0.469	-	-
HCM Control Delay (s)	12.5	-	-	\$1230.7	700.2	100.2	-	-
HCM Lane LOS	B	-	-	F	F	F	-	-
HCM 95th %tile Q(veh)	0.7	-	-	10	7.6	1.9	-	-

Notes  
 ~: Volume exceeds capacity    \$: Delay exceeds 300s    +: Computation Not Defined    \*: All major volume in platoon

Pepper Square TIA  
HCM 6th TWSC

Phase 1, P, & N - 2033 Background - PM  
20: Preston & Drive 2

Intersection						
Int Delay, s/veh	0.1					
Movement	WBL	WBR	NBT	NBR	SBL	SBT
Lane Configurations		↔	↔	↔	↔	↔
Traffic Vol, veh/h	0	15	2512	8	0	2177
Future Vol, veh/h	0	15	2512	8	0	2177
Conflicting Peds, #/hr	0	0	0	0	0	0
Sign Control	Stop	Stop	Free	Free	Free	Free
RT Channelized	-	None	-	None	-	None
Storage Length	-	0	-	-	-	-
Veh in Median Storage, #	0	-	0	-	-	0
Grade, %	0	-	0	-	-	0
Peak Hour Factor	95	95	95	95	95	95
Heavy Vehicles, %	2	2	2	2	2	2
Mvmt Flow	0	16	2644	8	0	2292

Major/Minor	Minor1	Major1	Major2				
Conflicting Flow All	-	1326	0	0	-	-	-
Stage 1	-	-	-	-	-	-	-
Stage 2	-	-	-	-	-	-	-
Critical Hdwy	-	7.14	-	-	-	-	-
Critical Hdwy Stg 1	-	-	-	-	-	-	-
Critical Hdwy Stg 2	-	-	-	-	-	-	-
Follow-up Hdwy	-	3.92	-	-	-	-	-
Pot Cap-1 Maneuver	0	125	-	-	0	-	-
Stage 1	0	-	-	-	0	-	-
Stage 2	0	-	-	-	0	-	-
Platoon blocked, %	-	-	-	-	-	-	-
Mov Cap-1 Maneuver	-	125	-	-	-	-	-
Mov Cap-2 Maneuver	-	-	-	-	-	-	-
Stage 1	-	-	-	-	-	-	-
Stage 2	-	-	-	-	-	-	-

Approach	WB	NB	SB
HCM Control Delay, s	37.9	0	0
HCM LOS	E		

Minor Lane/Major Mvmt	NBT	NBR	WBLn1	SBT
Capacity (veh/h)	-	-	125	-
HCM Lane V/C Ratio	-	-	0.126	-
HCM Control Delay (s)	-	-	37.9	-
HCM Lane LOS	-	-	E	-
HCM 95th %tile Q(veh)	-	-	0.4	-

Pepper Square TIA  
HCM 6th TWSC

Phase 1, P, & N - 2033 Background - PM  
21: Preston & Drive 1

Intersection						
Int Delay, s/veh	0					
Movement	WBL	WBR	NBT	NBR	SBL	SBT
Lane Configurations		↑↑↑	↑↑↑			↑↑↑
Traffic Vol, veh/h	0	2	2600	2	0	2009
Future Vol, veh/h	0	2	2600	2	0	2009
Conflicting Peds, #/hr	0	0	0	0	0	0
Sign Control	Stop	Stop	Free	Free	Free	Free
RT Channelized	-	None	-	None	-	None
Storage Length	-	0	-	-	-	-
Veh in Median Storage, #	0	-	0	-	0	0
Grade, %	0	-	0	-	0	0
Peak Hour Factor	95	95	95	95	95	95
Heavy Vehicles, %	2	2	2	2	2	2
Mvmt Flow	0	2	2737	2	0	2115

Major/Minor	Minor1	Major1	Major2		
Conflicting Flow All	-	1370	0	0	-
Stage 1	-	-	-	-	-
Stage 2	-	-	-	-	-
Critical Hdwy	-	7.14	-	-	-
Critical Hdwy Stg 1	-	-	-	-	-
Critical Hdwy Stg 2	-	-	-	-	-
Follow-up Hdwy	-	3.92	-	-	-
Pot Cap-1 Maneuver	0	117	-	0	-
Stage 1	0	-	-	0	-
Stage 2	0	-	-	0	-
Platoon blocked, %	-	-	-	-	-
Mov Cap-1 Maneuver	-	117	-	-	-
Mov Cap-2 Maneuver	-	-	-	-	-
Stage 1	-	-	-	-	-
Stage 2	-	-	-	-	-

Approach	WB	NB	SB
HCM Control Delay, s	36.3	0	0
HCM LOS	E		

Minor Lane/Major Mvmt	NBT	NBRWBLn1	SBT
Capacity (veh/h)	-	-	117
HCM Lane V/C Ratio	-	-	0.018
HCM Control Delay (s)	-	-	36.3
HCM Lane LOS	-	-	E
HCM 95th %tile Q(veh)	-	-	0.1

Pepper Square TIA  
HCM 6th TWSC

Phase 1, P, & N - 2033 Background - PM  
22: Drive 6 & Belt Line

Intersection						
Int Delay, s/veh	0.1					
Movement	EBT	EBR	WBL	WBT	NBL	NBR
Lane Configurations	↑↑↑			↑↑↑		↑
Traffic Vol, veh/h	1326	8	0	982	0	8
Future Vol, veh/h	1326	8	0	982	0	8
Conflicting Peds, #/hr	0	0	0	0	0	0
Sign Control	Free	Free	Free	Free	Stop	Stop
RT Channelized	-	None	-	None	-	None
Storage Length	-	-	-	-	-	0
Veh in Median Storage, #	0	-	-	0	0	-
Grade, %	0	-	-	0	0	-
Peak Hour Factor	93	93	93	93	93	93
Heavy Vehicles, %	2	2	2	2	2	2
Mvmt Flow	1426	9	0	1056	0	9

Major/Minor	Major1	Major2	Minor1		
Conflicting Flow All	0	0	-	-	718
Stage 1	-	-	-	-	-
Stage 2	-	-	-	-	-
Critical Hdwy	-	-	-	-	7.14
Critical Hdwy Stg 1	-	-	-	-	-
Critical Hdwy Stg 2	-	-	-	-	-
Follow-up Hdwy	-	-	-	-	3.92
Pot Cap-1 Maneuver	-	-	0	-	319
Stage 1	-	-	0	-	0
Stage 2	-	-	0	-	0
Platoon blocked, %	-	-	-	-	-
Mov Cap-1 Maneuver	-	-	-	-	319
Mov Cap-2 Maneuver	-	-	-	-	-
Stage 1	-	-	-	-	-
Stage 2	-	-	-	-	-

Approach	EB	WB	NB
HCM Control Delay, s	0	0	16.6
HCM LOS			C

Minor Lane/Major Mvmt	NBLn1	EBT	EBR	WBT
Capacity (veh/h)	319	-	-	-
HCM Lane V/C Ratio	0.027	-	-	-
HCM Control Delay (s)	16.6	-	-	-
HCM Lane LOS	C	-	-	-
HCM 95th %tile Q(veh)	0.1	-	-	-

Pepper Square TIA  
HCM 6th TWSC

Phase 1, P, & N - 2033 Background - PM  
24: Drive 5 & Belt Line

Intersection						
Int Delay, s/veh	0					
Movement	EBT	EBR	WBL	WBT	NBL	NBR
Lane Configurations	↑↑↑			↑↑↑		↑
Traffic Vol, veh/h	1308	0	0	936	0	5
Future Vol, veh/h	1308	0	0	936	0	5
Conflicting Peds, #/hr	0	0	0	0	0	0
Sign Control	Free	Free	Free	Free	Stop	Stop
RT Channelized	-	None	-	None	-	None
Storage Length	-	-	-	-	-	0
Veh in Median Storage, #	0	-	-	0	0	-
Grade, %	0	-	-	0	0	-
Peak Hour Factor	93	93	93	93	93	93
Heavy Vehicles, %	2	2	2	2	2	2
Mvmt Flow	1406	0	0	1006	0	5

Major/Minor	Major1	Major2	Minor1
Conflicting Flow All	0	0	- 703
Stage 1	-	-	-
Stage 2	-	-	-
Critical Hdwy	-	-	- 7.14
Critical Hdwy Stg 1	-	-	-
Critical Hdwy Stg 2	-	-	-
Follow-up Hdwy	-	-	- 3.92
Pot Cap-1 Maneuver	-	0	- 0 326
Stage 1	-	0	- 0
Stage 2	-	0	- 0
Platoon blocked, %	-	-	-
Mov Cap-1 Maneuver	-	-	- 326
Mov Cap-2 Maneuver	-	-	-
Stage 1	-	-	-
Stage 2	-	-	-

Approach	EB	WB	NB
HCM Control Delay, s	0	0	16.2
HCM LOS			C

Minor Lane/Major Mvmt	NBLn1	EBT	EBR	WBT
Capacity (veh/h)	326	-	-	-
HCM Lane V/C Ratio	0.016	-	-	-
HCM Control Delay (s)	16.2	-	-	-
HCM Lane LOS	C	-	-	-
HCM 95th %tile Q(veh)	0.1	-	-	-

Pepper Square TIA  
HCM 6th TWSC

Phase 1, P, & N - 2033 Background - PM  
25: Preston & Drive 4

Intersection						
Int Delay, s/veh	0.1					
Movement	WBL	WBR	NBT	NBR	SBL	SBT
Lane Configurations		↑↑↑	↑↑↑			↑↑↑
Traffic Vol, veh/h	0	11	2601	10	0	2177
Future Vol, veh/h	0	11	2601	10	0	2177
Conflicting Peds, #/hr	0	0	0	0	0	0
Sign Control	Stop	Stop	Free	Free	Free	Free
RT Channelized	-	None	-	None	-	None
Storage Length	-	0	-	-	-	-
Veh in Median Storage, #	0	-	0	-	0	-
Grade, %	0	-	0	-	0	-
Peak Hour Factor	95	95	95	95	95	95
Heavy Vehicles, %	2	2	2	2	2	2
Mvmt Flow	0	12	2738	11	0	2292

Major/Minor	Minor1	Major1	Major2
Conflicting Flow All	- 1375	0	0 - -
Stage 1	-	-	- - -
Stage 2	-	-	- - -
Critical Hdwy	- 7.14	-	- - -
Critical Hdwy Stg 1	-	-	- - -
Critical Hdwy Stg 2	-	-	- - -
Follow-up Hdwy	- 3.92	-	- - -
Pot Cap-1 Maneuver	0 116	-	- 0 -
Stage 1	0	-	- 0 -
Stage 2	0	-	- 0 -
Platoon blocked, %	-	-	- - -
Mov Cap-1 Maneuver	- 116	-	- - -
Mov Cap-2 Maneuver	-	-	- - -
Stage 1	-	-	- - -
Stage 2	-	-	- - -

Approach	WB	NB	SB
HCM Control Delay, s	39.4	0	0
HCM LOS	E		

Minor Lane/Major Mvmt	NBT	NBRWBLn1	SBT
Capacity (veh/h)	-	- 116	-
HCM Lane V/C Ratio	-	- 0.1	-
HCM Control Delay (s)	-	- 39.4	-
HCM Lane LOS	-	- E	-
HCM 95th %tile Q(veh)	-	- 0.3	-

**Intersection**

Int Delay, s/veh 0.3

Movement	WBL	WBR	NBT	NBR	SBL	SBT
Lane Configurations			↑ ↑ ↑			↑ ↑ ↑
Traffic Vol, veh/h	0	31	2601	18	0	2177
Future Vol, veh/h	0	31	2601	18	0	2177
Conflicting Peds, #/hr	0	0	0	0	0	0
Sign Control	Stop	Stop	Free	Free	Free	Free
RT Channelized	-	None	-	None	-	None
Storage Length	-	0	-	-	-	-
Veh in Median Storage, #	0	-	0	-	-	0
Grade, %	0	-	0	-	-	0
Peak Hour Factor	95	95	95	95	95	95
Heavy Vehicles, %	2	2	2	2	2	2
Mvmt Flow	0	33	2738	19	0	2292

**Major/Minor**

	Minor1	Major1	Major2		
Conflicting Flow All	-	1379	0	0	-
Stage 1	-	-	-	-	-
Stage 2	-	-	-	-	-
Critical Hdwy	-	7.14	-	-	-
Critical Hdwy Stg 1	-	-	-	-	-
Critical Hdwy Stg 2	-	-	-	-	-
Follow-up Hdwy	-	3.92	-	-	-
Pot Cap-1 Maneuver	0	115	-	-	0
Stage 1	0	-	-	-	0
Stage 2	0	-	-	-	0
Platoon blocked, %	-	-	-	-	-
Mov Cap-1 Maneuver	-	115	-	-	-
Mov Cap-2 Maneuver	-	-	-	-	-
Stage 1	-	-	-	-	-
Stage 2	-	-	-	-	-

**Approach**

	WB	NB	SB
HCM Control Delay, s	48.3	0	0
HCM LOS	E		

**Minor Lane/Major Mvmt**

	NBT	NBRWBLn1	SBT
Capacity (veh/h)	-	-	115
HCM Lane V/C Ratio	-	-	0.284
HCM Control Delay (s)	-	-	48.3
HCM Lane LOS	-	-	E
HCM 95th %tile Q(veh)	-	-	1.1



**Synchro™ Output - 2033 Background Plus Site-Generated  
Traffic – Phases 1, P and N**

Pepper Square TIA  
Lanes, Volumes, Timings

Phase 1, P, & N - 2033 Background + Site - AM  
4: Berry Trail & Belt Line

Lane Group	EBL	EBT	EBR	WBL	WBT	WBR	NBL	NBT	NBR	SBL	SBT	SBR
Lane Configurations	↔ ↗ ↘	↔ ↗ ↘	↔ ↗ ↘	↔ ↗ ↘	↔ ↗ ↘	↔ ↗ ↘	↔ ↗ ↘	↔ ↗ ↘	↔ ↗ ↘	↔ ↗ ↘	↔ ↗ ↘	↔ ↗ ↘
Traffic Volume (vph)	14	607	61	115	1050	22	177	1	88	36	7	65
Future Volume (vph)	14	607	61	115	1050	22	177	1	88	36	7	65
Ideal Flow (vphpl)	1900	1900	1900	1900	1900	1900	1900	1900	1900	1900	1900	1900
Storage Length (ft)	150		0	150		0	0		0	0		0
Storage Lanes	1		0	1		0	1		0	1		0
Taper Length (ft)	25			25			25			25		
Lane Util. Factor	1.00	0.91	0.91	1.00	0.91	0.91	1.00	1.00	1.00	1.00	1.00	1.00
Frt		0.986			0.997			0.851			0.864	
Fit Protected	0.950			0.950			0.950			0.950		
Satd. Flow (prot)	1770	5014	0	1770	5070	0	1770	1585	0	1770	1609	0
Fit Permitted	0.186			0.327			0.571			0.589		
Satd. Flow (perm)	346	5014	0	609	5070	0	1064	1585	0	1097	1609	0
Right Turn on Red			Yes			Yes			Yes			Yes
Satd. Flow (RTOR)		18			3			104				76
Link Speed (mph)		42			42			30				30
Link Distance (ft)		234			493			277				236
Travel Time (s)		3.8			8.0			6.3				5.4
Peak Hour Factor	0.85	0.85	0.85	0.85	0.85	0.85	0.85	0.85	0.85	0.85	0.85	0.85
Adj. Flow (vph)	16	714	72	135	1235	26	208	1	104	42	8	76
Shared Lane Traffic (%)												
Lane Group Flow (vph)	16	786	0	135	1261	0	208	105	0	42	84	0
Enter Blocked Intersection	No	No	No	No	No	No	No	No	No	No	No	No
Lane Alignment	Left	Left	Right	Left	Left	Right	Left	Left	Right	Left	Left	Right
Median Width(ft)		12			12			12				12
Link Offset(ft)		0			0			0				0
Crosswalk Width(ft)		16			16			16				16
Two way Left Turn Lane												
Headway Factor	1.00	1.00	1.00	1.00	1.00	1.00	1.00	1.00	1.00	1.00	1.00	1.00
Turning Speed (mph)	15		9	15		9	15		9	15		9
Number of Detectors	1	2		1	2		1	2		1	2	
Detector Template	Left	Thru		Left	Thru		Left	Thru		Left	Thru	
Leading Detector (ft)	20	100		20	100		20	100		20	100	
Trailing Detector (ft)	0	0		0	0		0	0		0	0	
Detector 1 Position(ft)	0	0		0	0		0	0		0	0	
Detector 1 Size(ft)	20	6		20	6		20	6		20	6	
Detector 1 Type	CI+Ex	CI+Ex		CI+Ex	CI+Ex		CI+Ex	CI+Ex		CI+Ex	CI+Ex	
Detector 1 Channel												
Detector 1 Extend (s)	0.0	0.0		0.0	0.0		0.0	0.0		0.0	0.0	
Detector 1 Queue (s)	0.0	0.0		0.0	0.0		0.0	0.0		0.0	0.0	
Detector 1 Delay (s)	0.0	0.0		0.0	0.0		0.0	0.0		0.0	0.0	
Detector 2 Position(ft)		94			94			94			94	
Detector 2 Size(ft)		6			6			6			6	
Detector 2 Type		CI+Ex			CI+Ex			CI+Ex			CI+Ex	
Detector 2 Channel												
Detector 2 Extend (s)		0.0			0.0			0.0			0.0	
Turn Type	D,P+P	NA		D,P+P	NA		D,P+P	NA		D,P+P	NA	
Protected Phases	3	8		7	4		1	6		5	2	
Permitted Phases	4			8			2			6		

Pepper Square TIA  
Lanes, Volumes, Timings

Phase 1, P, & N - 2033 Background + Site - AM  
4: Berry Trail & Belt Line

Lane Group	EBL	EBT	EBR	WBL	WBT	WBR	NBL	NBT	NBR	SBL	SBT	SBR
Detector Phase	3	8		7	4		1	6		5	2	
Switch Phase												
Minimum Initial (s)	4.0	4.0		4.0	4.0		4.0	4.0		4.0	4.0	
Minimum Split (s)	10.0	24.0		10.0	24.0		10.0	31.0		10.0	31.0	
Total Split (s)	15.0	99.0		15.0	99.0		25.0	31.0		15.0	21.0	
Total Split (%)	9.4%	61.9%		9.4%	61.9%		15.6%	19.4%		9.4%	13.1%	
Maximum Green (s)	9.0	93.0		9.0	93.0		19.0	25.0		9.0	15.0	
Yellow Time (s)	4.0	4.0		4.0	4.0		4.0	4.0		4.0	4.0	
All-Red Time (s)	2.0	2.0		2.0	2.0		2.0	2.0		2.0	2.0	
Lost Time Adjust (s)	0.0	0.0		0.0	0.0		0.0	0.0		0.0	0.0	
Total Lost Time (s)	6.0	6.0		6.0	6.0		6.0	6.0		6.0	6.0	
Lead/Lag	Lead	Lag		Lead	Lag		Lead	Lag		Lead	Lag	
Lead-Lag Optimize?	Yes	Yes		Yes	Yes		Yes	Yes		Yes	Yes	
Vehicle Extension (s)	1.0	1.0		1.0	1.0		1.0	1.0		1.0	1.0	
Recall Mode	None	C-Max		None	C-Max		None	None		None	None	
Walk Time (s)		4.0			4.0			4.0			4.0	
Flash Dont Walk (s)		14.0			14.0			21.0			21.0	
Pedestrian Calls (#/hr)		0			0			0			0	
Act Effct Green (s)	114.9	105.5		112.5	112.4		23.5	18.9		24.7	5.8	
Actuated g/C Ratio	0.72	0.66		0.70	0.70		0.15	0.12		0.15	0.04	
v/c Ratio	0.06	0.24		0.28	0.35		0.89	0.38		0.21	0.64	
Control Delay	8.4	11.5		3.5	3.4		96.7	14.9		55.6	39.6	
Queue Delay	0.0	0.0		0.0	0.0		0.0	0.0		0.0	0.0	
Total Delay	8.4	11.5		3.5	3.4		96.7	14.9		55.6	39.6	
LOS	A	B		A	A		F	B		E	D	
Approach Delay		11.4			3.4			69.3			44.9	
Approach LOS		B			A			E			D	
Queue Length 50th (ft)	4	83		11	66		204	1		37	8	
Queue Length 95th (ft)	m9	m95		17	100		266	51		68	59	
Internal Link Dist (ft)		154			413			197			156	
Turn Bay Length (ft)	150			150								
Base Capacity (vph)	335	3311		502	3562		248	335		217	219	
Starvation Cap Reductn	0	0		0	0		0	0		0	0	
Spillback Cap Reductn	0	0		0	0		0	0		0	0	
Storage Cap Reductn	0	0		0	0		0	0		0	0	
Reduced v/c Ratio	0.05	0.24		0.27	0.35		0.84	0.31		0.19	0.38	
Intersection Summary												
Area Type:	Other											
Cycle Length:	160											
Actuated Cycle Length:	160											
Offset:	11 (7%), Referenced to phase 4:EBWB and 8:EBWB, Start of Yellow											
Natural Cycle:	75											
Control Type:	Actuated-Coordinated											
Maximum v/c Ratio:	0.89											
Intersection Signal Delay:	15.6						Intersection LOS: B					
Intersection Capacity Utilization:	55.6%						ICU Level of Service B					
Analysis Period (min)	15											
m	Volume for 95th percentile queue is metered by upstream signal.											

Pepper Square TIA  
Lanes, Volumes, Timings

Phase 1, P, & N - 2033 Background + Site - AM  
4: Berry Trail & Belt Line

Splits and Phases: 4: Berry Trail & Belt Line

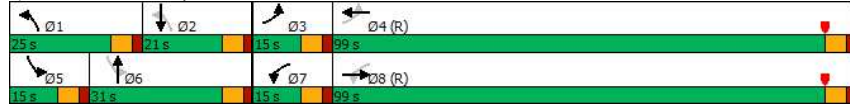

Pepper Square TIA  
Lanes, Volumes, Timings

Phase 1, P, & N - 2033 Background + Site - AM  
1335: Meadow Creek & Belt Line

	EBL	EBT	EBR	WBL	WBT	WBR	NBL	NBT	NBR	SBL	SBT	SBR
Lane Configurations	↑↑↑↑											
Traffic Volume (vph)	30	933	16	3	1234	18	21	3	6	8	10	84
Future Volume (vph)	30	933	16	3	1234	18	21	3	6	8	10	84
Ideal Flow (vphpl)	1900	1900	1900	1900	1900	1900	1900	1900	1900	1900	1900	1900
Storage Length (ft)	150		0	150		0	0		0	0		0
Storage Lanes	1		0	1		0	0		0	0		0
Taper Length (ft)	25			25			25			25		
Lane Util. Factor	1.00	0.91	0.91	1.00	0.91	0.91	1.00	1.00	1.00	1.00	1.00	1.00
Frt		0.997			0.998			0.975				0.890
Fit Protected	0.950			0.950				0.965				0.996
Satd. Flow (prot)	1770	5070	0	1770	5075	0	0	1753	0	0	1651	0
Fit Permitted	0.175			0.255				0.698				0.978
Satd. Flow (perm)	326	5070	0	475	5075	0	0	1268	0	0	1621	0
Right Turn on Red			Yes			Yes			Yes			Yes
Satd. Flow (RTOR)		3			3			6				84
Link Speed (mph)	42			42			30					30
Link Distance (ft)		1673			2404		392					423
Travel Time (s)		27.2			39.0		8.9					9.6
Peak Hour Factor	0.93	0.93	0.93	0.93	0.93	0.93	0.93	0.93	0.93	0.93	0.93	0.93
Adj. Flow (vph)	32	1003	17	3	1327	19	23	3	6	9	11	90
Shared Lane Traffic (%)												
Lane Group Flow (vph)	32	1020	0	3	1346	0	0	32	0	0	110	0
Enter Blocked Intersection	No	No	No	No	No	No	No	No	No	No	No	No
Lane Alignment	Left	Left	Right	Left	Left	Right	Left	Left	Right	Left	Left	Right
Median Width(ft)	12			12			0					0
Link Offset(ft)	0			0			0					0
Crosswalk Width(ft)	16			16			16					16
Two way Left Turn Lane												
Headway Factor	1.00	1.00	1.00	1.00	1.00	1.00	1.00	1.00	1.00	1.00	1.00	1.00
Turning Speed (mph)	15		9	15		9	15		9	15		9
Number of Detectors	1	1		1	1		1	1		1	1	1
Detector Template												
Leading Detector (ft)	50	50		50	50		50	50		50	50	
Trailing Detector (ft)	0	0		0	0		0	0		0	0	
Detector 1 Position(ft)	0	0		0	0		0	0		0	0	
Detector 1 Size(ft)	50	50		50	50		50	50		50	50	
Detector 1 Type	CI+Ex	CI+Ex		CI+Ex	CI+Ex		CI+Ex	CI+Ex		CI+Ex	CI+Ex	
Detector 1 Channel												
Detector 1 Extend (s)	0.0	0.0		0.0	0.0		0.0	0.0		0.0	0.0	
Detector 1 Queue (s)	0.0	0.0		0.0	0.0		0.0	0.0		0.0	0.0	
Detector 1 Delay (s)	0.0	0.0		0.0	0.0		0.0	0.0		0.0	0.0	
Turn Type	Perm	NA		Perm	NA		Perm	NA		Perm	NA	
Protected Phases		6 14			2 10			4 12			4 12	
Permitted Phases	6 14			2 10		4 12				4 12		
Detector Phase	6 14	6 14		2 10	2 10		4 12	4 12		4 12	4 12	
Switch Phase												
Minimum Initial (s)												
Minimum Split (s)												
Total Split (s)												



Pepper Square TIA  
Lanes, Volumes, Timings

Phase 1, P, & N - 2033 Background + Site - AM  
1335: Meadow Creek & Belt Line

Lane Group	Ø2	Ø4	Ø6	Ø10	Ø12	Ø14
Lane Configurations						
Traffic Volume (vph)						
Future Volume (vph)						
Ideal Flow (vphpl)						
Storage Length (ft)						
Storage Lanes						
Taper Length (ft)						
Lane Util. Factor						
Frt						
Fit Protected						
Satd. Flow (prot)						
Fit Permitted						
Satd. Flow (perm)						
Right Turn on Red						
Satd. Flow (RTOR)						
Link Speed (mph)						
Link Distance (ft)						
Travel Time (s)						
Peak Hour Factor						
Adj. Flow (vph)						
Shared Lane Traffic (%)						
Lane Group Flow (vph)						
Enter Blocked Intersection						
Lane Alignment						
Median Width(ft)						
Link Offset(ft)						
Crosswalk Width(ft)						
Two way Left Turn Lane						
Headway Factor						
Turning Speed (mph)						
Number of Detectors						
Detector Template						
Leading Detector (ft)						
Trailing Detector (ft)						
Detector 1 Position(ft)						
Detector 1 Size(ft)						
Detector 1 Type						
Detector 1 Channel						
Detector 1 Extend (s)						
Detector 1 Queue (s)						
Detector 1 Delay (s)						
Turn Type						
Protected Phases	2	4	6	10	12	14
Permitted Phases						
Detector Phase						
Switch Phase						
Minimum Initial (s)	12.0	6.0	12.0	12.0	12.0	6.0
Minimum Split (s)	17.0	23.5	17.0	20.0	23.0	20.0
Total Split (s)	96.0	22.0	96.0	22.0	20.0	22.0

Pepper Square TIA  
Lanes, Volumes, Timings

Phase 1, P, & N - 2033 Background + Site - AM  
1335: Meadow Creek & Belt Line

Lane Group	EBL	EBT	EBR	WBL	WBT	WBR	NBL	NBT	NBR	SBL	SBT	SBR
Total Split (%)												
Maximum Green (s)												
Yellow Time (s)												
All-Red Time (s)												
Lost Time Adjust (s)												
Total Lost Time (s)												
Lead/Lag												
Lead-Lag Optimize?												
Vehicle Extension (s)												
Recall Mode												
Walk Time (s)												
Flash Dont Walk (s)												
Pedestrian Calls (#/hr)												
Act Effect Green (s)	122.0	122.0		122.0	122.0			22.0				22.0
Actuated g/C Ratio	0.76	0.76		0.76	0.76			0.14				0.14
v/c Ratio	0.13	0.26		0.01	0.35			0.18				0.37
Control Delay	5.5	4.3		0.3	0.3			39.0				16.7
Queue Delay	0.0	0.0		0.0	0.0			0.0				0.0
Total Delay	5.5	4.3		0.3	0.3			39.0				16.7
LOS	A	A		A	A			D				B
Approach Delay		4.3			0.3			39.0				16.7
Approach LOS		A			A			D				B
Queue Length 50th (ft)	8	94		0	6			21				21
Queue Length 95th (ft)	18	110		m0	m5			47				67
Internal Link Dist (ft)		1593			2324			312				343
Turn Bay Length (ft)	150			150								
Base Capacity (vph)	256	3983		373	3987			274				410
Starvation Cap Reductn	0	0		0	0			0				0
Spillback Cap Reductn	0	0		0	0			0				0
Storage Cap Reductn	0	0		0	0			0				0
Reduced v/c Ratio	0.13	0.26		0.01	0.34			0.12				0.27

Intersection Summary

Area Type: Other  
 Cycle Length: 160  
 Actuated Cycle Length: 160  
 Offset: 82 (51%), Referenced to phase 2:WBTl and 6:EBTL, Start of Yellow  
 Natural Cycle: 85  
 Control Type: Actuated-Coordinated  
 Maximum v/c Ratio: 0.37  
 Intersection Signal Delay: 3.1 Intersection LOS: A  
 Intersection Capacity Utilization 40.0% ICU Level of Service A  
 Analysis Period (min) 15  
 m Volume for 95th percentile queue is metered by upstream signal.

Splits and Phases: 1335: Meadow Creek & Belt Line

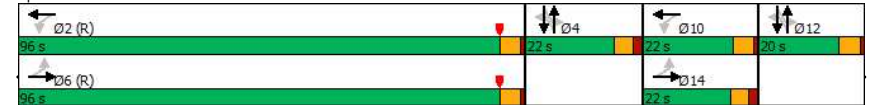

Pepper Square TIA  
Lanes, Volumes, Timings

Phase 1, P, & N - 2033 Background + Site - AM  
1335: Meadow Creek & Belt Line

Lane Group	Ø2	Ø4	Ø6	Ø10	Ø12	Ø14
Total Split (%)	60%	14%	60%	14%	13%	14%
Maximum Green (s)	91.0	16.5	91.0	17.0	15.0	16.5
Yellow Time (s)	4.0	3.7	4.0	4.0	4.0	3.7
All-Red Time (s)	1.0	1.8	1.0	1.0	1.0	1.8
Lost Time Adjust (s)						
Total Lost Time (s)						
Lead/Lag						
Lead-Lag Optimize?						
Vehicle Extension (s)	2.0	1.8	2.0	2.0	1.8	2.0
Recall Mode	C-Max	None	C-Min	None	None	None
Walk Time (s)	4.0	4.0	4.0	4.0	4.0	4.0
Flash Dont Walk (s)	8.0	14.0	8.0	8.0	14.0	8.0
Pedestrian Calls (#/hr)	0	0	0	0	0	0
Act Effect Green (s)						
Actuated g/C Ratio						
v/c Ratio						
Control Delay						
Queue Delay						
Total Delay						
LOS						
Approach Delay						
Approach LOS						
Queue Length 50th (ft)						
Queue Length 95th (ft)						
Internal Link Dist (ft)						
Turn Bay Length (ft)						
Base Capacity (vph)						
Starvation Cap Reductn						
Spillback Cap Reductn						
Storage Cap Reductn						
Reduced v/c Ratio						
Intersection Summary						

Pepper Square TIA  
Lanes, Volumes, Timings

Phase 1, P, & N - 2033 Background + Site - AM  
1365: Preston & Arapahoe

Lane Group	EBU	EBL	EBT	EBR	WBL	WBT	WBR	NBU	NBL	NBT	NBR	SBU
Lane Configurations		↔	↔		↔	↔		↔	↔	↔		
Traffic Volume (vph)	3	146	299	175	143	771	174	1	177	1842	137	4
Future Volume (vph)	3	146	299	175	143	771	174	1	177	1842	137	4
Ideal Flow (vphpl)	1900	1900	1900	1900	1900	1900	1900	1900	1900	1900	1900	1900
Storage Length (ft)		150		0	150		0		300		0	
Storage Lanes		2		0	2		0		2		0	
Taper Length (ft)		25			25				25			
Lane Util. Factor	0.91	0.97	0.91	0.91	0.97	0.91	0.91	0.91	0.97	0.91	0.91	0.91
Frt			0.945		0.972					0.990		
Fit Protected		0.950			0.950				0.950			
Satd. Flow (prot)	0	3433	4806	0	3433	4943	0	0	3433	5034	0	0
Fit Permitted		0.950			0.950				0.950			
Satd. Flow (perm)	0	3433	4806	0	3433	4943	0	0	3433	5034	0	0
Right Turn on Red			Yes			Yes				Yes		
Satd. Flow (RTOR)			88			32				10		
Link Speed (mph)		42			42				42			
Link Distance (ft)		1672			1942				3054			
Travel Time (s)		27.1			31.5				49.6			
Peak Hour Factor	0.95	0.95	0.95	0.95	0.95	0.95	0.95	0.95	0.95	0.95	0.95	0.95
Adj. Flow (vph)	3	154	315	184	151	812	183	1	186	1939	144	4
Shared Lane Traffic (%)												
Lane Group Flow (vph)	0	157	499	0	151	995	0	0	187	2083	0	0
Enter Blocked Intersection	No	No	No	No	No	No	No	No	No	No	No	No
Lane Alignment	R NA	Left	Left	Right	Left	Left	Right	R NA	Left	Left	Right	R NA
Median Width(ft)		24			24				24			
Link Offset(ft)		0			0				0			
Crosswalk Width(ft)			16			16					16	
Two way Left Turn Lane												
Headway Factor	1.00	1.00	1.00	1.00	1.00	1.00	1.00	1.00	1.00	1.00	1.00	1.00
Turning Speed (mph)	9	15		9	15		9	9	15		9	9
Number of Detectors	1	1	1		1	1		1	1	1		1
Detector Template												
Leading Detector (ft)	50	50	50		50	50		50	50	50		50
Trailing Detector (ft)	0	0	0		0	0		0	0	0		0
Detector 1 Position(ft)	0	0	0		0	0		0	0	0		0
Detector 1 Size(ft)	50	50	50		50	50		50	50	50		50
Detector 1 Type	CI+Ex	CI+Ex	CI+Ex		CI+Ex	CI+Ex		CI+Ex	CI+Ex	CI+Ex		CI+Ex
Detector 1 Channel												
Detector 1 Extend (s)	0.0	0.0	0.0		0.0	0.0		0.0	0.0	0.0		0.0
Detector 1 Queue (s)	0.0	0.0	0.0		0.0	0.0		0.0	0.0	0.0		0.0
Detector 1 Delay (s)	0.0	0.0	0.0		0.0	0.0		0.0	0.0	0.0		0.0
Turn Type	Prot	Prot	NA		Prot	NA		Prot	Prot	NA		Prot
Protected Phases	3	3	8		7	4		1	1	6		5
Permitted Phases												
Detector Phase	3	3	8		7	4		1	1	6		5
Switch Phase												
Minimum Initial (s)	3.0	3.0	18.0		3.0	18.0		3.0	3.0	18.0		3.0
Minimum Split (s)	10.0	10.0	36.7		21.0	36.3		10.0	10.0	35.7		10.0
Total Split (s)	13.0	13.0	44.0		18.0	49.0		14.0	14.0	78.0		20.0

Pepper Square TIA  
Lanes, Volumes, Timings

Phase 1, P, & N - 2033 Background + Site - AM  
1365: Preston & Arapaho

Lane Group	SBL	SBT	SBR
Lane Configurations	↑↑	↑↑↑	
Traffic Volume (vph)	104	1933	227
Future Volume (vph)	104	1933	227
Ideal Flow (vphpl)	1900	1900	1900
Storage Length (ft)	250		0
Storage Lanes	2		0
Taper Length (ft)	25		
Lane Util. Factor	0.97	0.91	0.91
Frt		0.984	
Fit Protected	0.950		
Satd. Flow (prot)	3433	5004	0
Fit Permitted	0.950		
Satd. Flow (perm)	3433	5004	0
Right Turn on Red			Yes
Satd. Flow (RTOR)		18	
Link Speed (mph)		48	
Link Distance (ft)		5087	
Travel Time (s)		72.3	
Peak Hour Factor	0.95	0.95	0.95
Adj. Flow (vph)	109	2035	239
Shared Lane Traffic (%)			
Lane Group Flow (vph)	113	2274	0
Enter Blocked Intersection	No	No	No
Lane Alignment	Left	Left	Right
Median Width(ft)		24	
Link Offset(ft)		0	
Crosswalk Width(ft)		16	
Two way Left Turn Lane			
Headway Factor	1.00	1.00	1.00
Turning Speed (mph)	15		9
Number of Detectors	1	1	
Detector Template			
Leading Detector (ft)	50	50	
Trailing Detector (ft)	0	0	
Detector 1 Position(ft)	0	0	
Detector 1 Size(ft)	50	50	
Detector 1 Type	CI+Ex	CI+Ex	
Detector 1 Channel			
Detector 1 Extend (s)	0.0	0.0	
Detector 1 Queue (s)	0.0	0.0	
Detector 1 Delay (s)	0.0	0.0	
Turn Type	Prot	NA	
Protected Phases	5	2	
Permitted Phases			
Detector Phase	5	2	
Switch Phase			
Minimum Initial (s)	3.0	18.0	
Minimum Split (s)	10.0	37.7	
Total Split (s)	20.0	84.0	

09/22/2022 11:12 am  
Kimley-Horn

Synchro 11 Report  
Page 9

Pepper Square TIA  
Lanes, Volumes, Timings

Phase 1, P, & N - 2033 Background + Site - AM  
1365: Preston & Arapaho

Lane Group	EBU	EBL	EBT	EBR	WBL	WBT	WBR	NBU	NBL	NBT	NBR	SBU
Total Split (%)	8.1%	8.1%	27.5%		11.3%	30.6%		8.8%	8.8%	48.8%		12.5%
Maximum Green (s)	7.5	7.5	38.7		12.5	43.7		8.5	8.5	72.3		14.5
Yellow Time (s)	3.0	3.0	4.3		3.0	4.3		3.0	3.0	4.7		3.0
All-Red Time (s)	2.5	2.5	1.0		2.5	1.0		2.5	2.5	1.0		2.5
Lost Time Adjust (s)		-1.0	-1.4		-1.0	-1.0			-1.0	-1.7		
Total Lost Time (s)		4.5	3.9		4.5	4.3			4.5	4.0		
Lead/Lag	Lead	Lead	Lag		Lead	Lag		Lead	Lead	Lead		Lag
Lead-Lag Optimize?	Yes	Yes	Yes		Yes	Yes		Yes	Yes	Yes		Yes
Vehicle Extension (s)	0.8	0.8	2.5		0.8	1.8		1.5	1.5	1.7		1.5
Recall Mode	None	None	Max		None	None		None	None	Max		None
Walk Time (s)			4.0			4.0				4.0		
Flash Dont Walk (s)			27.0			27.0				26.0		
Pedestrian Calls (#/hr)			0			0				0		
Act Effect Green (s)		8.5	42.6		11.0	44.7			9.5	74.0		
Actuated g/C Ratio		0.05	0.27		0.07	0.28			0.06	0.46		
v/c Ratio		0.86	0.37		0.64	0.71			0.92	0.89		
Control Delay		110.4	39.5		79.9	63.3			109.0	27.6		
Queue Delay		0.0	0.0		0.0	0.0			0.0	0.0		
Total Delay		110.4	39.5		79.9	63.3			109.0	27.6		
LOS		F	D		E	E			F	C		
Approach Delay			56.5			65.5				34.3		
Approach LOS			E			E				C		
Queue Length 50th (ft)		86	128		80	376			95	776		
Queue Length 95th (ft)		#157	163		119	437			m#137	820		
Internal Link Dist (ft)			1592			1862				2974		
Turn Bay Length (ft)		150			150				300			
Base Capacity (vph)		182	1343		289	1404			203	2333		
Starvation Cap Reductn		0	0		0	0			0	0		
Spillback Cap Reductn		0	0		0	0			0	0		
Storage Cap Reductn		0	0		0	0			0	0		
Reduced v/c Ratio		0.86	0.37		0.52	0.71			0.92	0.89		

Intersection Summary

Area Type: Other  
 Cycle Length: 160  
 Actuated Cycle Length: 160  
 Offset: 11 (7%), Referenced to phase 2:SBT, Start of Yellow  
 Natural Cycle: 130  
 Control Type: Actuated-Coordinated  
 Maximum v/c Ratio: 0.92  
 Intersection Signal Delay: 47.9  
 Intersection LOS: D  
 Intersection Capacity Utilization 84.9%  
 ICU Level of Service E  
 Analysis Period (min) 15  
 # 95th percentile volume exceeds capacity, queue may be longer.  
 Queue shown is maximum after two cycles.  
 m Volume for 95th percentile queue is metered by upstream signal.

Splits and Phases: 1365: Preston & Arapaho

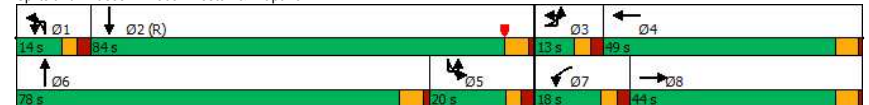

Pepper Square TIA  
Lanes, Volumes, Timings

Phase 1, P, & N - 2033 Background + Site - AM  
1365: Preston & Arapaho

Lane Group	SBL	SBT	SBR
Total Split (%)	12.5%	52.5%	
Maximum Green (s)	14.5	78.3	
Yellow Time (s)	3.0	4.7	
All-Red Time (s)	2.5	1.0	
Lost Time Adjust (s)	-1.0	-1.7	
Total Lost Time (s)	4.5	4.0	
Lead/Lag	Lag	Lag	
Lead-Lag Optimize?	Yes	Yes	
Vehicle Extension (s)	1.5	1.5	
Recall Mode	None	C-Max	
Walk Time (s)		4.0	
Flash Dont Walk (s)		28.0	
Pedestrian Calls (#/hr)		0	
Act Effect Green (s)	15.5	80.0	
Actuated g/C Ratio	0.10	0.50	
v/c Ratio	0.34	0.91	
Control Delay	79.2	48.6	
Queue Delay	0.0	0.0	
Total Delay	79.2	48.6	
LOS	E	D	
Approach Delay		50.1	
Approach LOS		D	
Queue Length 50th (ft)	57	816	
Queue Length 95th (ft)	m72	898	
Internal Link Dist (ft)		5007	
Turn Bay Length (ft)	250		
Base Capacity (vph)	332	2511	
Starvation Cap Reductn	0	0	
Spillback Cap Reductn	0	0	
Storage Cap Reductn	0	0	
Reduced v/c Ratio	0.34	0.91	

Intersection Summary

Pepper Square TIA  
Lanes, Volumes, Timings

Phase 1, P, & N - 2033 Background + Site - AM  
1367: Preston & Belt Line

Lane Group	EBU	EBL	EBT	EBR	WBL	WBT	WBR	NBL	NBT	NBR	SBU	SBL
Lane Configurations		↑↑	↑↑↑	↑	↑	↑↑↑	↑	↑↑	↑↑↑	↑	↑	↑
Traffic Volume (vph)	11	171	474	278	92	936	183	366	1763	22	2	183
Future Volume (vph)	11	171	474	278	92	936	183	366	1763	22	2	183
Ideal Flow (vphpl)	1900	1900	1900	1900	1900	1900	1900	1900	1900	1900	1900	1900
Storage Length (ft)		150		150	200		0	250		0		200
Storage Lanes		2		1	1		0	2		0		1
Taper Length (ft)		25			25			25				25
Lane Util. Factor	0.91	0.97	0.91	1.00	1.00	0.91	0.91	0.97	0.91	0.91	0.91	1.00
Fit			0.850			0.975		0.998				
Fit Protected		0.950			0.950			0.950				0.950
Satd. Flow (prot)	0	3433	5085	1583	1770	4958	0	3433	5075	0	0	1770
Fit Permitted		0.950			0.950			0.950				0.950
Satd. Flow (perm)	0	3433	5085	1583	1770	4958	0	3433	5075	0	0	1770
Right Turn on Red				Yes		Yes			Yes			
Satd. Flow (RTOR)				186		25			1			
Link Speed (mph)			42			42			42			
Link Distance (ft)			925			394			261			
Travel Time (s)			15.0			6.4			4.2			
Peak Hour Factor	0.95	0.95	0.95	0.95	0.95	0.95	0.95	0.95	0.95	0.95	0.95	0.95
Adj. Flow (vph)	12	180	499	293	97	985	193	385	1856	23	2	193
Shared Lane Traffic (%)												
Lane Group Flow (vph)	0	192	499	293	97	1178	0	385	1879	0	0	195
Enter Blocked Intersection	No	No	No	No	No	No	No	No	No	No	No	No
Lane Alignment	R NA	Left	Left	Right	Left	Left	Right	Left	Left	Right	R NA	Left
Median Width(ft)			24			24			24			
Link Offset(ft)			0			0			0			
Crosswalk Width(ft)				16		16			16			
Two way Left Turn Lane												
Headway Factor	1.00	1.00	1.00	1.00	1.00	1.00	1.00	1.00	1.00	1.00	1.00	1.00
Turning Speed (mph)	9	15		9	15		9	15		9	9	15
Number of Detectors	1	1	1	1	1	1	1	1	1	1	1	1
Detector Template												
Leading Detector (ft)	50	50	50	50	50	50	50	50	50	50	50	50
Trailing Detector (ft)	0	0	0	0	0	0	0	0	0	0	0	0
Detector 1 Position(ft)	0	0	0	0	0	0	0	0	0	0	0	0
Detector 1 Size(ft)	50	50	50	50	50	50	50	50	50	50	50	50
Detector 1 Type	CI+Ex	CI+Ex	CI+Ex	CI+Ex	CI+Ex	CI+Ex	CI+Ex	CI+Ex	CI+Ex	CI+Ex	CI+Ex	CI+Ex
Detector 1 Channel												
Detector 1 Extend (s)	0.0	0.0	0.0	0.0	0.0	0.0	0.0	0.0	0.0	0.0	0.0	0.0
Detector 1 Queue (s)	0.0	0.0	0.0	0.0	0.0	0.0	0.0	0.0	0.0	0.0	0.0	0.0
Detector 1 Delay (s)	0.0	0.0	0.0	0.0	0.0	0.0	0.0	0.0	0.0	0.0	0.0	0.0
Turn Type	Prot	Prot	NA	Perm	Prot	NA	Prot	NA	Prot	NA	Prot	Prot
Protected Phases	3	3	8		7	4		1	6		5	5
Permitted Phases				8								
Detector Phase	3	3	8	8	7	4		1	6		5	5
Switch Phase												
Minimum Initial (s)	3.0	3.0	18.0	18.0	3.0	18.0		3.0	18.0		3.0	3.0
Minimum Split (s)	11.0	11.0	32.5	32.5	8.0	32.5		8.0	33.0		11.0	11.0
Total Split (s)	16.0	16.0	42.0	42.0	20.0	46.0		18.0	76.0		22.0	22.0

Pepper Square TIA  
Lanes, Volumes, Timings

Phase 1, P, & N - 2033 Background + Site - AM  
1367: Preston & Belt Line

Lane Group	SBT	SBR
Lane Configurations	↑↑↑	↑
Traffic Volume (vph)	1923	285
Future Volume (vph)	1923	285
Ideal Flow (vphpl)	1900	1900
Storage Length (ft)		300
Storage Lanes		1
Taper Length (ft)		
Lane Util. Factor	0.91	1.00
Frt		0.850
Fit Protected		
Satd. Flow (prot)	5085	1583
Fit Permitted		
Satd. Flow (perm)	5085	1583
Right Turn on Red		Yes
Satd. Flow (RTOR)		173
Link Speed (mph)	40	
Link Distance (ft)	3054	
Travel Time (s)	52.1	
Peak Hour Factor	0.95	0.95
Adj. Flow (vph)	2024	300
Shared Lane Traffic (%)		
Lane Group Flow (vph)	2024	300
Enter Blocked Intersection	No	No
Lane Alignment	Left	Right
Median Width(ft)	24	
Link Offset(ft)	0	
Crosswalk Width(ft)	16	
Two way Left Turn Lane		
Headway Factor	1.00	1.00
Turning Speed (mph)		9
Number of Detectors	1	1
Detector Template		
Leading Detector (ft)	50	50
Trailing Detector (ft)	0	0
Detector 1 Position(ft)	0	0
Detector 1 Size(ft)	50	50
Detector 1 Type	CI+Ex	CI+Ex
Detector 1 Channel		
Detector 1 Extend (s)	0.0	0.0
Detector 1 Queue (s)	0.0	0.0
Detector 1 Delay (s)	0.0	0.0
Turn Type	NA	Perm
Protected Phases	2	
Permitted Phases		2
Detector Phase	2	2
Switch Phase		
Minimum Initial (s)	18.0	18.0
Minimum Split (s)	33.0	33.0
Total Split (s)	80.0	80.0

Pepper Square TIA  
Lanes, Volumes, Timings

Phase 1, P, & N - 2033 Background + Site - AM  
1367: Preston & Belt Line

Lane Group	EBU	EBL	EBT	EBR	WBL	WBT	WBR	NBL	NBT	NBR	SBU	SBL
Total Split (%)	10.0%	10.0%	26.3%	26.3%	12.5%	28.8%		11.3%	47.5%		13.8%	13.8%
Maximum Green (s)	11.0	11.0	36.5	36.5	15.0	40.5		13.0	70.0		17.0	17.0
Yellow Time (s)	3.0	3.0	4.0	4.0	3.0	4.0		3.0	4.4		3.0	3.0
All-Red Time (s)	2.0	2.0	1.5	1.5	2.0	1.5		2.0	1.6		2.0	2.0
Lost Time Adjust (s)		-1.0	-1.5	-1.5	-1.0	-1.5		-1.0	-1.7			-1.0
Total Lost Time (s)		4.0	4.0	4.0	4.0	4.0		4.0	4.3			4.0
Lead/Lag	Lead	Lead	Lead	Lead	Lag	Lag		Lag	Lag		Lead	Lead
Lead-Lag Optimize?	Yes	Yes	Yes	Yes	Yes	Yes		Yes	Yes		Yes	Yes
Vehicle Extension (s)	1.3	1.3	1.3	1.3	1.0	1.3		1.6	2.0		1.5	1.5
Recall Mode	None	None	Max	Max	None	Max		None	C-Max		None	None
Walk Time (s)			7.0	7.0		7.0			7.0			
Flash Dont Walk (s)			20.0	20.0		20.0			20.0			
Pedestrian Calls (#/hr)			0	0		0			0			
Act Effect Green (s)		11.6	38.0	38.0	16.0	42.4		14.0	71.7			18.0
Actuated g/C Ratio		0.07	0.24	0.24	0.10	0.26		0.09	0.45			0.11
v/c Ratio		0.77	0.41	0.57	0.55	0.89		1.28	0.83			0.98
Control Delay		81.2	44.2	17.9	55.5	39.4		190.2	25.8			125.1
Queue Delay		0.0	0.0	0.0	0.0	0.0		0.0	20.8			0.0
Total Delay		81.2	44.2	17.9	55.5	39.4		190.2	46.7			125.1
LOS		F	D	B	E	D		F	D			F
Approach Delay			43.6			40.6			71.1			
Approach LOS			D			D			E			
Queue Length 50th (ft)		104	169	111	98	437		~268	755			197
Queue Length 95th (ft)		#159	210	229	m166	517		#380	543			m#269
Internal Link Dist (ft)			845			314			181			
Turn Bay Length (ft)		150		150	200			250				200
Base Capacity (vph)		257	1207	517	177	1331		300	2274			199
Starvation Cap Reductn		0	0	0	0	0		0	458			0
Spillback Cap Reductn		0	0	0	0	0		0	0			0
Storage Cap Reductn		0	0	0	0	0		0	0			0
Reduced v/c Ratio		0.75	0.41	0.57	0.55	0.89		1.28	1.03			0.98
<b>Intersection Summary</b>												
Area Type:	Other											
Cycle Length:	160											
Actuated Cycle Length:	160											
Offset:	81 (51%), Referenced to phase 6:NBT, Start of Yellow											
Natural Cycle:	100											
Control Type:	Actuated-Coordinated											
Maximum v/c Ratio:	1.28											
Intersection Signal Delay:	44.8						Intersection LOS: D					
Intersection Capacity Utilization:	88.5%						ICU Level of Service E					
Analysis Period (min)	15											
~ Volume exceeds capacity, queue is theoretically infinite. Queue shown is maximum after two cycles.												
# 95th percentile volume exceeds capacity, queue may be longer. Queue shown is maximum after two cycles.												
m Volume for 95th percentile queue is metered by upstream signal.												

Pepper Square TIA  
Lanes, Volumes, Timings

Phase 1, P, & N - 2033 Background + Site - AM  
1367: Preston & Belt Line

Splits and Phases: 1367: Preston & Belt Line

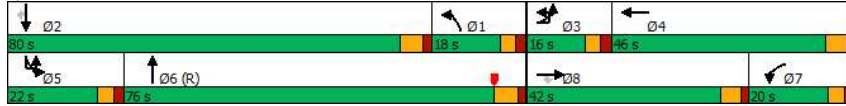

Pepper Square TIA  
Lanes, Volumes, Timings

Phase 1, P, & N - 2033 Background + Site - AM  
1367: Preston & Belt Line

Lane Group	SBT	SBR
Total Split (%)	50.0%	50.0%
Maximum Green (s)	74.0	74.0
Yellow Time (s)	4.4	4.4
All-Red Time (s)	1.6	1.6
Lost Time Adjust (s)	-1.7	-1.7
Total Lost Time (s)	4.3	4.3
Lead/Lag	Lead	Lead
Lead-Lag Optimize?	Yes	Yes
Vehicle Extension (s)	2.5	2.5
Recall Mode	Max	Max
Walk Time (s)	7.0	7.0
Flash Dont Walk (s)	20.0	20.0
Pedestrian Calls (#/hr)	0	0
Act Effct Green (s)	75.7	75.7
Actuated g/C Ratio	0.47	0.47
v/c Ratio	0.84	0.36
Control Delay	17.4	1.5
Queue Delay	0.0	0.0
Total Delay	17.4	1.5
LOS	B	A
Approach Delay	23.8	
Approach LOS	C	
Queue Length 50th (ft)	437	4
Queue Length 95th (ft)	425	m6
Internal Link Dist (ft)	2974	
Turn Bay Length (ft)		300
Base Capacity (vph)	2405	840
Starvation Cap Reductn	0	0
Spillback Cap Reductn	2	0
Storage Cap Reductn	0	0
Reduced v/c Ratio	0.84	0.36
<b>Intersection Summary</b>		

Pepper Square TIA  
Lanes, Volumes, Timings

Phase 1, P, & N - 2033 Background + Site - AM  
1368: Preston & Alexis

Lane Group	EBL	EBT	EBR	WBL	WBT	WBR	NBU	NBL	NBT	NBR	SBL	SBT
Lane Configurations	↔	↔	↔	↔	↔	↔	↔	↔	↔	↔	↔	↔
Traffic Volume (vph)	16	5	29	310	22	147	3	21	2055	128	120	2149
Future Volume (vph)	16	5	29	310	22	147	3	21	2055	128	120	2149
Ideal Flow (vphpl)	1900	1900	1900	1900	1900	1900	1900	1900	1900	1900	1900	1900
Storage Length (ft)	0	0	175	0	0	150	150	150	150	150	150	150
Storage Lanes	1	1	2	1	1	1	1	1	1	1	1	1
Taper Length (ft)	25	25	25	25	25	25	25	25	25	25	25	25
Lane Util. Factor	0.91	0.91	1.00	0.97	1.00	1.00	0.91	1.00	0.91	1.00	1.00	0.91
Fr	0.850			0.850			0.850			0.850		
Fit Protected	0.950	0.969	0.950	0.950	0.950	0.950	0.950	0.950	0.950	0.950	0.950	0.950
Satd. Flow (prot)	1610	3285	1583	3433	1863	1583	0	1770	5085	1583	1770	5085
Fit Permitted	0.950	0.969	0.950	0.950	0.950	0.950	0.044	0.044	0.044	0.044	0.044	0.044
Satd. Flow (perm)	1610	3285	1583	3433	1863	1583	0	82	5085	1583	80	5085
Right Turn on Red	Yes			Yes			Yes			Yes		
Satd. Flow (RTOR)	125			85			89			89		
Link Speed (mph)	30			30			43			42		
Link Distance (ft)	660			627			2867			173		
Travel Time (s)	15.0			14.3			45.5			2.8		
Peak Hour Factor	0.92	0.92	0.92	0.92	0.92	0.92	0.92	0.92	0.92	0.92	0.92	0.92
Adj. Flow (vph)	17	5	32	337	24	160	3	23	2234	139	130	2336
Shared Lane Traffic (%)	50%											
Lane Group Flow (vph)	8	14	32	337	24	160	0	26	2234	139	130	2336
Enter Blocked Intersection	No	No	No	No	No	No	No	No	No	No	No	No
Lane Alignment	Left	Left	Right	Left	Left	Right	R NA	Left	Left	Right	Left	Left
Median Width(ft)	24			24			12			12		
Link Offset(ft)	0			0			0			0		
Crosswalk Width(ft)	16			16			16			16		
Two way Left Turn Lane												
Headway Factor	1.00	1.00	1.00	1.00	1.00	1.00	1.00	1.00	1.00	1.00	1.00	1.00
Turning Speed (mph)	15	9	15	9	15	9	15	9	15	9	15	9
Number of Detectors	1	1	1	1	1	1	1	1	1	1	1	1
Detector Template												
Leading Detector (ft)	50	50	50	50	50	50	50	50	50	50	50	50
Trailing Detector (ft)	0	0	0	0	0	0	0	0	0	0	0	0
Detector 1 Position(ft)	0	0	0	0	0	0	0	0	0	0	0	0
Detector 1 Size(ft)	50	50	50	50	50	50	50	50	50	50	50	50
Detector 1 Type	Cl+Ex	Cl+Ex	Cl+Ex	Cl+Ex	Cl+Ex	Cl+Ex	Cl+Ex	Cl+Ex	Cl+Ex	Cl+Ex	Cl+Ex	Cl+Ex
Detector 1 Channel												
Detector 1 Extend (s)	0.0	0.0	0.0	0.0	0.0	0.0	0.0	0.0	0.0	0.0	0.0	0.0
Detector 1 Queue (s)	0.0	0.0	0.0	0.0	0.0	0.0	0.0	0.0	0.0	0.0	0.0	0.0
Detector 1 Delay (s)	0.0	0.0	0.0	0.0	0.0	0.0	0.0	0.0	0.0	0.0	0.0	0.0
Turn Type	Split	NA	Perm	Split	NA	pm+ov	custom	D.P+P	NA	Perm	D.P+P	NA
Protected Phases	3	3	4	4	4	5	1	6	6	5	5	2
Permitted Phases	3			4			1 2			6 6		
Detector Phase	3	3	3	4	4	5	1	1	6	6	5	2
Switch Phase												
Minimum Initial (s)	6.0	6.0	6.0	8.0	8.0	3.0	3.0	3.0	14.0	14.0	3.0	14.0
Minimum Split (s)	27.0	27.0	27.0	27.0	27.0	8.4	8.4	8.4	24.0	24.0	8.4	24.0
Total Split (s)	13.0	13.0	13.0	29.0	29.0	15.0	18.0	18.0	103.0	103.0	15.0	100.0

Pepper Square TIA  
Lanes, Volumes, Timings

Phase 1, P, & N - 2033 Background + Site - AM  
1368: Preston & Alexis

Lane Group	SBR
Lane Configurations	↔
Traffic Volume (vph)	23
Future Volume (vph)	23
Ideal Flow (vphpl)	1900
Storage Length (ft)	150
Storage Lanes	1
Taper Length (ft)	25
Lane Util. Factor	1.00
Fr	0.850
Fit Protected	1583
Satd. Flow (prot)	1583
Fit Permitted	1583
Satd. Flow (perm)	1583
Right Turn on Red	Yes
Satd. Flow (RTOR)	78
Link Speed (mph)	0.92
Link Distance (ft)	25
Travel Time (s)	25
Peak Hour Factor	0.92
Adj. Flow (vph)	25
Shared Lane Traffic (%)	25
Lane Group Flow (vph)	25
Enter Blocked Intersection	No
Lane Alignment	Right
Median Width(ft)	12
Link Offset(ft)	0
Crosswalk Width(ft)	16
Two way Left Turn Lane	
Headway Factor	1.00
Turning Speed (mph)	9
Number of Detectors	1
Detector Template	
Leading Detector (ft)	50
Trailing Detector (ft)	0
Detector 1 Position(ft)	0
Detector 1 Size(ft)	50
Detector 1 Type	Cl+Ex
Detector 1 Channel	
Detector 1 Extend (s)	0.0
Detector 1 Queue (s)	0.0
Detector 1 Delay (s)	0.0
Turn Type	Perm
Protected Phases	2
Permitted Phases	2
Detector Phase	2
Switch Phase	
Minimum Initial (s)	14.0
Minimum Split (s)	24.0
Total Split (s)	100.0

Pepper Square TIA  
Lanes, Volumes, Timings

Phase 1, P, & N - 2033 Background + Site - AM  
1368: Preston & Alexis

Lane Group	EBL	EBT	EBR	WBL	WBT	WBR	NBU	NBL	NBT	NBR	SBL	SBT
Total Split (%)	8.1%	8.1%	8.1%	18.1%	18.1%	9.4%	11.3%	11.3%	64.4%	64.4%	9.4%	62.5%
Maximum Green (s)	8.0	8.0	8.0	24.0	24.0	10.6	13.6	13.6	97.0	97.0	10.6	94.0
Yellow Time (s)	4.0	4.0	4.0	4.0	4.0	3.4	3.4	3.4	4.5	4.5	3.4	4.5
All-Red Time (s)	1.0	1.0	1.0	1.0	1.0	1.0	1.0	1.0	1.5	1.5	1.0	1.5
Lost Time Adjust (s)	-1.0	-1.0	0.0	-1.0	-1.0	0.0			-1.0	-2.0	0.0	-1.0
Total Lost Time (s)	4.0	4.0	5.0	4.0	4.0	4.4			3.4	4.0	6.0	3.4
Lead/Lag	Lead	Lead	Lead	Lag	Lag	Lag	Lead	Lead	Lead	Lead	Lag	Lag
Lead-Lag Optimize?	Yes	Yes	Yes	Yes	Yes	Yes	Yes	Yes	Yes	Yes	Yes	Yes
Vehicle Extension (s)	2.0	2.0	2.0	2.0	2.0	1.2	1.2	1.2	2.5	2.5	1.2	2.5
Recall Mode	None	None	None	None	None	None	None	None	Max	Max	None	C-Max
Walk Time (s)	4.0	4.0	4.0	4.0	4.0				4.0	4.0		4.0
Flash Dont Walk (s)	18.0	18.0	18.0	18.0	18.0				14.0	14.0		14.0
Pedestrian Calls (#/hr)	0	0	0	0	0				0	0		0
Act Effect Green (s)	7.2	7.2	6.2	21.0	21.0	32.1		120.6	107.0	105.0	119.2	116.6
Actuated g/C Ratio	0.04	0.04	0.04	0.13	0.13	0.20		0.75	0.67	0.66	0.74	0.73
v/c Ratio	0.11	0.10	0.18	0.75	0.10	0.42		0.22	0.66	0.13	0.71	0.63
Control Delay	76.7	74.6	2.1	77.4	60.2	23.4		10.5	9.9	1.5	46.2	3.2
Queue Delay	0.0	0.0	0.0	0.0	0.0	0.0		0.0	0.0	0.0	0.0	0.1
Total Delay	76.7	74.6	2.1	77.4	60.2	23.4		10.5	9.9	1.5	46.2	3.2
LOS	E	E	A	E	E	C		B	A	A	D	A
Approach Delay		32.0			60.0				9.5			5.4
Approach LOS		C			E				A			A
Queue Length 50th (ft)	8	7	0	177	22	59		3	320	0	77	90
Queue Length 95th (ft)	30	21	0	226	51	118		11	324	10	#180	97
Internal Link Dist (ft)		580			547				2787			93
Turn Bay Length (ft)				175				150		150		
Base Capacity (vph)	90	184	197	541	293	385		216	3401	1069	182	3704
Starvation Cap Reductn	0	0	0	0	0	0		0	0	0	0	204
Spillback Cap Reductn	0	0	0	0	0	0		0	0	0	0	0
Storage Cap Reductn	0	0	0	0	0	0		0	0	0	0	0
Reduced v/c Ratio	0.09	0.08	0.16	0.62	0.08	0.42		0.12	0.66	0.13	0.71	0.67

Intersection Summary

Area Type: Other  
 Cycle Length: 160  
 Actuated Cycle Length: 160  
 Offset: 89 (56%), Referenced to phase 2:NBSB, Start of Yellow  
 Natural Cycle: 120  
 Control Type: Actuated-Coordinated  
 Maximum v/c Ratio: 0.75  
 Intersection Signal Delay: 12.7 Intersection LOS: B  
 Intersection Capacity Utilization 72.9% ICU Level of Service C  
 Analysis Period (min) 15  
 # 95th percentile volume exceeds capacity, queue may be longer.  
 Queue shown is maximum after two cycles.  
 m Volume for 95th percentile queue is metered by upstream signal.

Splits and Phases: 1368: Preston & Alexis

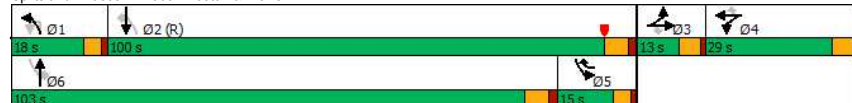

Pepper Square TIA  
Lanes, Volumes, Timings

Phase 1, P, & N - 2033 Background + Site - AM  
1368: Preston & Alexis

Lane Group	SBR
Total Split (%)	62.5%
Maximum Green (s)	94.0
Yellow Time (s)	4.5
All-Red Time (s)	1.5
Lost Time Adjust (s)	0.0
Total Lost Time (s)	6.0
Lead/Lag	Lag
Lead-Lag Optimize?	Yes
Vehicle Extension (s)	2.5
Recall Mode	C-Max
Walk Time (s)	4.0
Flash Dont Walk (s)	14.0
Pedestrian Calls (#/hr)	0
Act Effect Green (s)	114.6
Actuated g/C Ratio	0.72
v/c Ratio	0.02
Control Delay	0.0
Queue Delay	0.0
Total Delay	0.0
LOS	A
Approach Delay	
Approach LOS	
Queue Length 50th (ft)	0
Queue Length 95th (ft)	m0
Internal Link Dist (ft)	
Turn Bay Length (ft)	150
Base Capacity (vph)	1155
Starvation Cap Reductn	0
Spillback Cap Reductn	0
Storage Cap Reductn	0
Reduced v/c Ratio	0.02

Intersection Summary

Area Type: Other  
 Cycle Length: 160  
 Actuated Cycle Length: 160  
 Offset: 89 (56%), Referenced to phase 2:NBSB, Start of Yellow  
 Natural Cycle: 120  
 Control Type: Actuated-Coordinated  
 Maximum v/c Ratio: 0.75  
 Intersection Signal Delay: 12.7 Intersection LOS: B  
 Intersection Capacity Utilization 72.9% ICU Level of Service C  
 Analysis Period (min) 15  
 # 95th percentile volume exceeds capacity, queue may be longer.  
 Queue shown is maximum after two cycles.  
 m Volume for 95th percentile queue is metered by upstream signal.



Pepper Square TIA  
Lanes, Volumes, Timings

Phase 1, P, & N - 2033 Background + Site - AM  
1369: Preston & Belt Line Village Driveway

Lane Group	EBL	EBT	EBR	WBL	WBT	WBR	NBL	NBT	NBR	SBU	SBL	SBT
Lane Configurations		↕↕		↕	↕		↕	↕↕↕			↕	↕↕↕
Traffic Volume (vph)	41	1	29	158	2	66	25	2036	51	3	120	2180
Future Volume (vph)	41	1	29	158	2	66	25	2036	51	3	120	2180
Ideal Flow (vphpl)	1900	1900	1900	1900	1900	1900	1900	1900	1900	1900	1900	1900
Storage Length (ft)	0		0	0		0	100		0		100	
Storage Lanes	0		0	1		0	1		0		1	
Taper Length (ft)	25			25			25				25	
Lane Util. Factor	0.95	0.95	0.95	1.00	1.00	1.00	1.00	0.91	0.91	0.91	1.00	0.91
Frt		0.939			0.854			0.996				0.998
Fit Protected		0.972		0.950			0.950				0.950	
Satd. Flow (prot)	0	3230	0	1770	1591	0	1770	5065	0	0	1770	5075
Fit Permitted		0.781		0.703			0.038				0.044	
Satd. Flow (perm)	0	2596	0	1310	1591	0	71	5065	0	0	82	5075
Right Turn on Red			Yes		Yes			Yes				
Satd. Flow (RTOR)		32			73			4				2
Link Speed (mph)		30			30			42				38
Link Distance (ft)		303			249			252				191
Travel Time (s)		6.9			5.7			4.1				3.4
Peak Hour Factor	0.90	0.90	0.90	0.90	0.90	0.90	0.90	0.90	0.90	0.90	0.90	0.90
Adj. Flow (vph)	46	1	32	176	2	73	28	2262	57	3	133	2422
Shared Lane Traffic (%)												
Lane Group Flow (vph)	0	79	0	176	75	0	28	2319	0	0	136	2455
Enter Blocked Intersection	No	No	No	No	No	No	No	No	No	No	No	No
Lane Alignment	Left	Left	Right	Left	Left	Right	Left	Left	Right	R NA	Left	Left
Median Width(ft)		12			12			12				12
Link Offset(ft)		0			0			0				0
Crosswalk Width(ft)		16			16			16				16
Two way Left Turn Lane												
Headway Factor	1.00	1.00	1.00	1.00	1.00	1.00	1.00	1.00	1.00	1.00	1.00	1.00
Turning Speed (mph)	15		9	15		9	15		9	9	15	
Number of Detectors	1	1		1	1		1	1		1	1	1
Detector Template												
Leading Detector (ft)	50	50		50	50		50	50		50	50	50
Trailing Detector (ft)	0	0		0	0		0	0		0	0	0
Detector 1 Position(ft)	0	0		0	0		0	0		0	0	0
Detector 1 Size(ft)	50	50		50	50		50	50		50	50	50
Detector 1 Type	CI+Ex	CI+Ex		CI+Ex	CI+Ex		CI+Ex	CI+Ex		CI+Ex	CI+Ex	CI+Ex
Detector 1 Channel												
Detector 1 Extend (s)	0.0	0.0		0.0	0.0		0.0	0.0		0.0	0.0	0.0
Detector 1 Queue (s)	0.0	0.0		0.0	0.0		0.0	0.0		0.0	0.0	0.0
Detector 1 Delay (s)	0.0	0.0		0.0	0.0		0.0	0.0		0.0	0.0	0.0
Turn Type	Perm	NA		Perm	NA		D.P+P	NA		custom	D.P+P	NA
Protected Phases		8			4			1 6			5	2
Permitted Phases		8		4			2			5	6	
Detector Phase	8	8		4	4		1	6		5	5	2
Switch Phase												
Minimum Initial (s)	20.0	20.0		20.0	20.0		5.0	20.0		5.0	5.0	20.0
Minimum Split (s)	25.0	25.0		25.0	25.0		10.0	26.0		10.0	10.0	26.0
Total Split (s)	47.0	47.0		47.0	47.0		20.0	98.0		15.0	15.0	93.0

Pepper Square TIA  
Lanes, Volumes, Timings

Phase 1, P, & N - 2033 Background + Site - AM  
1369: Preston & Belt Line Village Driveway

Lane Group	SBR
Lane Configurations	↕
Traffic Volume (vph)	30
Future Volume (vph)	30
Ideal Flow (vphpl)	1900
Storage Length (ft)	0
Storage Lanes	0
Taper Length (ft)	
Lane Util. Factor	0.91
Frt	
Fit Protected	
Satd. Flow (prot)	0
Fit Permitted	
Satd. Flow (perm)	0
Right Turn on Red	Yes
Satd. Flow (RTOR)	
Link Speed (mph)	
Link Distance (ft)	
Travel Time (s)	
Peak Hour Factor	0.90
Adj. Flow (vph)	33
Shared Lane Traffic (%)	
Lane Group Flow (vph)	0
Enter Blocked Intersection	No
Lane Alignment	Right
Median Width(ft)	
Link Offset(ft)	
Crosswalk Width(ft)	
Two way Left Turn Lane	
Headway Factor	1.00
Turning Speed (mph)	9
Number of Detectors	
Detector Template	
Leading Detector (ft)	
Trailing Detector (ft)	
Detector 1 Position(ft)	
Detector 1 Size(ft)	
Detector 1 Type	
Detector 1 Channel	
Detector 1 Extend (s)	
Detector 1 Queue (s)	
Detector 1 Delay (s)	
Turn Type	
Protected Phases	
Permitted Phases	
Detector Phase	
Switch Phase	
Minimum Initial (s)	
Minimum Split (s)	
Total Split (s)	

Pepper Square TIA  
Lanes, Volumes, Timings

Phase 1, P, & N - 2033 Background + Site - AM  
1369: Preston & Belt Line Village Driveway



Lane Group	EBL	EBT	EBR	WBL	WBT	WBR	NBL	NBT	NBR	SBU	SBL	SBT
Total Split (%)	29.4%	29.4%		29.4%	29.4%		12.5%	61.3%		9.4%	9.4%	58.1%
Maximum Green (s)	42.3	42.3		42.3	42.3		15.0	93.7		10.0	10.0	88.7
Yellow Time (s)	3.0	3.0		3.0	3.0		3.0	3.0		3.0	3.0	3.0
All-Red Time (s)	1.7	1.7		1.7	1.7		2.0	1.3		2.0	2.0	1.3
Lost Time Adjust (s)		-1.0		-1.0	-1.0		-1.0	-2.0			-1.0	-2.0
Total Lost Time (s)		3.7		3.7	3.7		4.0	2.3			4.0	2.3
Lead/Lag							Lead	Lead		Lag	Lag	Lag
Lead-Lag Optimize?							Yes	Yes		Yes	Yes	Yes
Vehicle Extension (s)	2.0	2.0		2.0	2.0		1.5	3.0		1.5	1.5	3.3
Recall Mode	None	None		None	None		None	None		None	None	C-Max
Walk Time (s)	5.0	5.0		5.0	5.0			7.0				7.0
Flash Dont Walk (s)	15.0	15.0		15.0	15.0			8.0				8.0
Pedestrian Calls (#/hr)	0	0		0	0			0				0
Act Effect Green (s)		27.8		27.8	27.8		122.1	94.4			120.5	120.1
Actuated g/C Ratio		0.17		0.17	0.17		0.76	0.59			0.75	0.75
v/c Ratio		0.17		0.78	0.22		0.24	0.78			0.38	0.64
Control Delay		33.1		84.8	12.4		16.2	9.0			27.0	3.0
Queue Delay		0.0		0.0	0.0		0.0	2.3			0.0	0.1
Total Delay		33.1		84.8	12.4		16.2	11.3			27.0	3.1
LOS		C		F	B		B	B			C	A
Approach Delay		33.1			63.1			11.4				4.3
Approach LOS		C			E			B				A
Queue Length 50th (ft)		22		179	2		2	166			79	79
Queue Length 95th (ft)		44		254	47		m4	146			m134	117
Internal Link Dist (ft)		223			169			172				111
Turn Bay Length (ft)							100				100	
Base Capacity (vph)		725		354	483		225	3052			355	3809
Starvation Cap Reductn		0		0	0		0	64			0	331
Spillback Cap Reductn		1		0	7		0	573			0	0
Storage Cap Reductn		0		0	0		0	0			0	0
Reduced v/c Ratio		0.11		0.50	0.16		0.12	0.94			0.38	0.71

Intersection Summary

Area Type: Other  
 Cycle Length: 160  
 Actuated Cycle Length: 160  
 Offset: 86 (54%), Referenced to phase 2:NBSB, Start of Yellow  
 Natural Cycle: 75  
 Control Type: Actuated-Coordinated  
 Maximum v/c Ratio: 0.78  
 Intersection Signal Delay: 10.7 Intersection LOS: B  
 Intersection Capacity Utilization 74.0% ICU Level of Service D  
 Analysis Period (min) 15  
 m Volume for 95th percentile queue is metered by upstream signal.

Splits and Phases: 1369: Preston & Belt Line Village Driveway

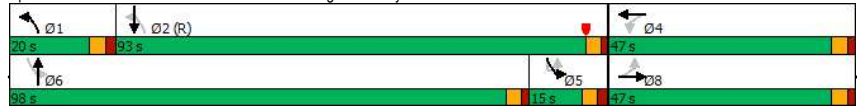

Pepper Square TIA  
Lanes, Volumes, Timings

Phase 1, P, & N - 2033 Background + Site - AM  
1369: Preston & Belt Line Village Driveway



Lane Group	SBR
Total Split (%)	
Maximum Green (s)	
Yellow Time (s)	
All-Red Time (s)	
Lost Time Adjust (s)	
Total Lost Time (s)	
Lead/Lag	
Lead-Lag Optimize?	
Vehicle Extension (s)	
Recall Mode	
Walk Time (s)	
Flash Dont Walk (s)	
Pedestrian Calls (#/hr)	
Act Effect Green (s)	
Actuated g/C Ratio	
v/c Ratio	
Control Delay	
Queue Delay	
Total Delay	
LOS	
Approach Delay	
Approach LOS	
Queue Length 50th (ft)	
Queue Length 95th (ft)	
Internal Link Dist (ft)	
Turn Bay Length (ft)	
Base Capacity (vph)	
Starvation Cap Reductn	
Spillback Cap Reductn	
Storage Cap Reductn	
Reduced v/c Ratio	

Intersection Summary

Area Type: Other  
 Cycle Length: 160  
 Actuated Cycle Length: 160  
 Offset: 86 (54%), Referenced to phase 2:NBSB, Start of Yellow  
 Natural Cycle: 75  
 Control Type: Actuated-Coordinated  
 Maximum v/c Ratio: 0.78  
 Intersection Signal Delay: 10.7 Intersection LOS: B  
 Intersection Capacity Utilization 74.0% ICU Level of Service D  
 Analysis Period (min) 15  
 m Volume for 95th percentile queue is metered by upstream signal.

Pepper Square TIA  
Lanes, Volumes, Timings

Phase 1, P, & N - 2033 Background + Site - AM  
1371: Preston & Spring Valley



Lane Group	EBL	EBT	EBR	WBL	WBT	WBR	NBL	NBT	NBR	SBU	SBL	SBT
Lane Configurations	↑↑	↑↑↑		↑↑	↑↑↑		↑↑	↑↑↑			↑↑	↑↑↑
Traffic Volume (vph)	187	375	259	92	755	169	118	1706	78	1	185	2242
Future Volume (vph)	187	375	259	92	755	169	118	1706	78	1	185	2242
Ideal Flow (vphpl)	1900	1900	1900	1900	1900	1900	1900	1900	1900	1900	1900	1900
Storage Length (ft)	225		0	225		0	225		0		275	
Storage Lanes	2		0	2		0	2		0		2	
Taper Length (ft)	25			25			25				25	
Lane Util. Factor	0.97	0.91	0.91	0.97	0.91	0.91	0.97	0.91	0.91	0.91	0.97	0.91
Fr't		0.939			0.973			0.993				0.984
Fit Protected	0.950			0.950			0.950				0.950	
Satd. Flow (prot)	3433	4775	0	3433	4948	0	3433	5050	0	0	3433	5004
Fit Permitted	0.950			0.950			0.950				0.950	
Satd. Flow (perm)	3433	4775	0	3433	4948	0	3433	5050	0	0	3433	5004
Right Turn on Red			Yes			Yes			Yes			
Satd. Flow (RTOR)		103			30			5				19
Link Speed (mph)		38			42			41				38
Link Distance (ft)		3259			5488			2139				1208
Travel Time (s)		58.5			89.1			35.6				21.7
Peak Hour Factor	0.96	0.96	0.96	0.96	0.96	0.96	0.96	0.96	0.96	0.96	0.96	0.96
Adj. Flow (vph)	195	391	270	96	786	176	123	1777	81	1	193	2335
Shared Lane Traffic (%)												
Lane Group Flow (vph)	195	661	0	96	962	0	123	1858	0	0	194	2605
Enter Blocked Intersection	No	No	No	No	No	No	No	No	No	No	No	No
Lane Alignment	Left	Left	Right	Left	Left	Right	Left	Left	Right	R NA	Left	Left
Median Width(ft)		24			24			24				24
Link Offset(ft)		0			0			0				0
Crosswalk Width(ft)		16			16			16				16
Two way Left Turn Lane												
Headway Factor	1.00	1.00	1.00	1.00	1.00	1.00	1.00	1.00	1.00	1.00	1.00	1.00
Turning Speed (mph)	15		9	15		9	15		9	9	15	
Number of Detectors	1	1		1	1		1	1		1	1	1
Detector Template												
Leading Detector (ft)	50	50		50	50		50	50		50	50	50
Trailing Detector (ft)	0	0		0	0		0	0		0	0	0
Detector 1 Position(ft)	0	0		0	0		0	0		0	0	0
Detector 1 Size(ft)	50	50		50	50		50	50		50	50	50
Detector 1 Type	Cl+Ex	Cl+Ex		Cl+Ex	Cl+Ex		Cl+Ex	Cl+Ex		Cl+Ex	Cl+Ex	Cl+Ex
Detector 1 Channel												
Detector 1 Extend (s)	0.0	0.0		0.0	0.0		0.0	0.0		0.0	0.0	0.0
Detector 1 Queue (s)	0.0	0.0		0.0	0.0		0.0	0.0		0.0	0.0	0.0
Detector 1 Delay (s)	0.0	0.0		0.0	0.0		0.0	0.0		0.0	0.0	0.0
Turn Type	Prot	NA		Prot	NA		Prot	NA		Prot	Prot	NA
Protected Phases	3	8		7	4		1	6		5	5	2
Permitted Phases												
Detector Phase	3	8		7	4		1	6		5	5	2
Switch Phase												
Minimum Initial (s)	6.0	12.0		3.0	12.0		3.0	13.0		3.0	3.0	18.0
Minimum Split (s)	11.0	27.5		11.0	27.5		11.0	28.0		11.0	11.0	28.0
Total Split (s)	15.0	43.0		16.0	44.0		13.0	71.0		30.0	30.0	88.0

Pepper Square TIA  
Lanes, Volumes, Timings

Phase 1, P, & N - 2033 Background + Site - AM  
1371: Preston & Spring Valley



Lane Group	SBR
Lane Configurations	↑↑
Traffic Volume (vph)	259
Future Volume (vph)	259
Ideal Flow (vphpl)	1900
Storage Length (ft)	0
Storage Lanes	0
Taper Length (ft)	
Lane Util. Factor	0.91
Fr't	
Fit Protected	
Satd. Flow (prot)	0
Fit Permitted	
Satd. Flow (perm)	0
Right Turn on Red	Yes
Satd. Flow (RTOR)	
Link Speed (mph)	
Link Distance (ft)	
Travel Time (s)	
Peak Hour Factor	0.96
Adj. Flow (vph)	270
Shared Lane Traffic (%)	
Lane Group Flow (vph)	0
Enter Blocked Intersection	No
Lane Alignment	Right
Median Width(ft)	
Link Offset(ft)	
Crosswalk Width(ft)	
Two way Left Turn Lane	
Headway Factor	1.00
Turning Speed (mph)	9
Number of Detectors	
Detector Template	
Leading Detector (ft)	
Trailing Detector (ft)	
Detector 1 Position(ft)	
Detector 1 Size(ft)	
Detector 1 Type	
Detector 1 Channel	
Detector 1 Extend (s)	
Detector 1 Queue (s)	
Detector 1 Delay (s)	
Turn Type	
Protected Phases	
Permitted Phases	
Detector Phase	
Switch Phase	
Minimum Initial (s)	
Minimum Split (s)	
Total Split (s)	

Pepper Square TIA  
Lanes, Volumes, Timings

Phase 1, P, & N - 2033 Background + Site - AM  
1371: Preston & Spring Valley



Lane Group	EBL	EBT	EBR	WBL	WBT	WBR	NBL	NBT	NBR	SBU	SBL	SBT
Total Split (%)	9.4%	26.9%		10.0%	27.5%		8.1%	44.4%		18.8%	18.8%	55.0%
Maximum Green (s)	10.0	37.5		11.0	38.5		8.0	65.0		25.0	25.0	82.0
Yellow Time (s)	3.0	4.0		3.0	4.0		3.0	4.5		3.0	3.0	4.5
All-Red Time (s)	2.0	1.5		2.0	1.5		2.0	1.5		2.0	2.0	1.5
Lost Time Adjust (s)	-1.0	-1.5		-1.0	-1.5		-1.0	-2.0		-1.0	-2.0	
Total Lost Time (s)	4.0	4.0		4.0	4.0		4.0	4.0		4.0	4.0	4.0
Lead/Lag	Lead	Lead		Lag	Lag		Lead	Lead		Lag	Lag	Lag
Lead-Lag Optimize?	Yes	Yes		Yes	Yes		Yes	Yes		Yes	Yes	Yes
Vehicle Extension (s)	0.8	2.0		0.8	2.0		0.8	2.5		0.8	0.8	2.4
Recall Mode	None	None		None	None		None	None		None	None	C-Max
Walk Time (s)		4.0			4.0			4.0				4.0
Flash Dont Walk (s)		18.0			18.0			18.0				18.0
Pedestrian Calls (#/hr)		0			0			0				0
Act Effect Green (s)	10.8	25.1		21.7	36.0		8.9	67.7		29.6	29.6	88.4
Actuated g/C Ratio	0.07	0.16		0.14	0.22		0.06	0.42		0.18	0.18	0.55
v/c Ratio	0.84	0.79		0.21	0.85		0.65	0.87		0.31	0.31	0.94
Control Delay	94.8	59.5		63.2	59.9		93.5	44.3		72.6	72.6	51.7
Queue Delay	0.0	0.0		0.0	0.0		0.0	0.0		0.0	0.0	0.0
Total Delay	94.8	59.5		63.2	59.9		93.5	44.3		72.6	72.6	51.7
LOS	F	E		E	E		F	D		E	E	D
Approach Delay		67.6			60.2			47.4				53.1
Approach LOS		E			E			D				D
Queue Length 50th (ft)	106	223		50	363		68	444		103	103	1004
Queue Length 95th (ft)	#175	261		m47	m338		m105	537		m144	m144	#1121
Internal Link Dist (ft)		3179			5408			2059				1128
Turn Bay Length (ft)	225			225			225			275		
Base Capacity (vph)	236	1241		465	1259		201	2145		634	634	2772
Starvation Cap Reductn	0	0		0	0		0	0		0	0	0
Spillback Cap Reductn	0	0		0	0		0	0		0	0	0
Storage Cap Reductn	0	0		0	0		0	0		0	0	0
Reduced v/c Ratio	0.83	0.53		0.21	0.76		0.61	0.87		0.31	0.31	0.94

Intersection Summary

Area Type: Other  
 Cycle Length: 160  
 Actuated Cycle Length: 160  
 Offset: 156 (98%), Referenced to phase 2:SBT, Start of Yellow  
 Natural Cycle: 100  
 Control Type: Actuated-Coordinated  
 Maximum v/c Ratio: 0.94  
 Intersection Signal Delay: 54.4 Intersection LOS: D  
 Intersection Capacity Utilization 89.5% ICU Level of Service E  
 Analysis Period (min) 15  
 # 95th percentile volume exceeds capacity, queue may be longer.  
 Queue shown is maximum after two cycles.  
 m Volume for 95th percentile queue is metered by upstream signal.

Splits and Phases: 1371: Preston & Spring Valley

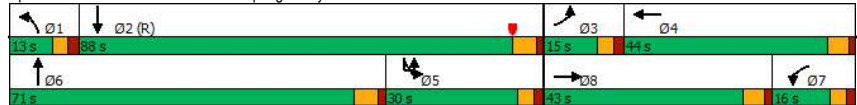

Pepper Square TIA  
Lanes, Volumes, Timings

Phase 1, P, & N - 2033 Background + Site - AM  
1371: Preston & Spring Valley



Lane Group	SBR
Total Split (%)	55.0%
Maximum Green (s)	82.0
Yellow Time (s)	4.5
All-Red Time (s)	1.5
Lost Time Adjust (s)	-2.0
Total Lost Time (s)	4.0
Lead/Lag	Lag
Lead-Lag Optimize?	Yes
Vehicle Extension (s)	2.4
Recall Mode	C-Max
Walk Time (s)	4.0
Flash Dont Walk (s)	18.0
Pedestrian Calls (#/hr)	0
Act Effect Green (s)	88.4
Actuated g/C Ratio	0.55
v/c Ratio	0.94
Control Delay	51.7
Queue Delay	0.0
Total Delay	51.7
LOS	D
Approach Delay	53.1
Approach LOS	D
Queue Length 50th (ft)	1004
Queue Length 95th (ft)	#1121
Internal Link Dist (ft)	1128
Turn Bay Length (ft)	
Base Capacity (vph)	2772
Starvation Cap Reductn	0
Spillback Cap Reductn	0
Storage Cap Reductn	0
Reduced v/c Ratio	0.94

Intersection Summary

Area Type: Other  
 Cycle Length: 160  
 Actuated Cycle Length: 160  
 Offset: 156 (98%), Referenced to phase 2:SBT, Start of Yellow  
 Natural Cycle: 100  
 Control Type: Actuated-Coordinated  
 Maximum v/c Ratio: 0.94  
 Intersection Signal Delay: 54.4 Intersection LOS: D  
 Intersection Capacity Utilization 89.5% ICU Level of Service E  
 Analysis Period (min) 15  
 # 95th percentile volume exceeds capacity, queue may be longer.  
 Queue shown is maximum after two cycles.  
 m Volume for 95th percentile queue is metered by upstream signal.

Pepper Square TIA  
Lanes, Volumes, Timings

Phase 1, P, & N - 2033 Background + Site - AM  
1405: Prestonwood & Belt Line

Lane Group	EBU	EBL	EBT	EBR	WBL	WBT	WBR	NBL	NBT	NBR	SBL	SBT
Lane Configurations			↑↑↑		↑↑↑				↑		↑↑↑	↑
Traffic Volume (vph)	4	42	872	3	4	1692	50	1	0	5	40	1
Future Volume (vph)	4	42	872	3	4	1692	50	1	0	5	40	1
Ideal Flow (vphpl)	1900	1900	1900	1900	1900	1900	1900	1900	1900	1900	1900	1900
Storage Length (ft)		200		0	200		0	0		0	300	
Storage Lanes		1		0	1		0	0		0	2	
Taper Length (ft)		25			25			25			25	
Lane Util. Factor	0.91	1.00	0.91	0.91	1.00	0.91	0.91	1.00	1.00	1.00	0.97	0.95
Fr						0.996			0.887			0.854
Fit Protected		0.950			0.950				0.992		0.950	
Satd. Flow (prot)	0	1770	5085	0	1770	5065	0	0	1639	0	3433	1511
Fit Permitted		0.097			0.293				0.992		0.950	
Satd. Flow (perm)	0	181	5085	0	546	5065	0	0	1639	0	3433	1511
Right Turn on Red			Yes		Yes		Yes		Yes			
Satd. Flow (RTOR)			1		6		131					34
Link Speed (mph)		42			42		30					30
Link Distance (ft)		1445			2036		315					868
Travel Time (s)		23.5			33.1		7.2					19.7
Peak Hour Factor	0.95	0.95	0.95	0.95	0.95	0.95	0.95	0.95	0.95	0.95	0.95	0.95
Adj. Flow (vph)	4	44	918	3	4	1781	53	1	0	5	42	1
Shared Lane Traffic (%)												
Lane Group Flow (vph)	0	48	921	0	4	1834	0	0	6	0	42	35
Enter Blocked Intersection	No	No	No	No	No	No	No	No	No	No	No	No
Lane Alignment	R NA	Left	Left	Right	Left	Left	Right	Left	Left	Right	Left	Left
Median Width(ft)		24			24		24				24	
Link Offset(ft)		0			0		0				0	
Crosswalk Width(ft)			16		16		16				16	
Two way Left Turn Lane												
Headway Factor	1.00	1.00	1.00	1.00	1.00	1.00	1.00	1.00	1.00	1.00	1.00	1.00
Turning Speed (mph)	9	15		9	15		9	15		9	15	
Number of Detectors	1	1	1		1	1		1	1		1	1
Detector Template												
Leading Detector (ft)	50	50	50		50	50		50	50		50	50
Trailing Detector (ft)	0	0	0		0	0		0	0		0	0
Detector 1 Position(ft)	0	0	0		0	0		0	0		0	0
Detector 1 Size(ft)	50	50	50		50	50		50	50		50	50
Detector 1 Type	Cl+Ex	Cl+Ex	Cl+Ex		Cl+Ex	Cl+Ex		Cl+Ex	Cl+Ex		Cl+Ex	Cl+Ex
Detector 1 Channel												
Detector 1 Extend (s)	0.0	0.0	0.0		0.0	0.0		0.0	0.0		0.0	0.0
Detector 1 Queue (s)	0.0	0.0	0.0		0.0	0.0		0.0	0.0		0.0	0.0
Detector 1 Delay (s)	0.0	0.0	0.0		0.0	0.0		0.0	0.0		0.0	0.0
Turn Type	custom	D,P+P	NA		D,P+P	NA		Split	NA		Split	NA
Protected Phases		1	6		5	2		3	3		4	4
Permitted Phases		1	2		6							
Detector Phase	1	1	6		5	2		3	3		4	4
Switch Phase												
Minimum Initial (s)	3.0	3.0	15.0		3.0	15.0		5.0	5.0		7.0	7.0
Minimum Split (s)	8.0	8.0	22.0		8.0	24.0		23.0	23.0		23.2	23.2
Total Split (s)	15.0	15.0	109.0		15.0	109.0		18.0	18.0		18.0	18.0

Pepper Square TIA  
Lanes, Volumes, Timings

Phase 1, P, & N - 2033 Background + Site - AM  
1405: Prestonwood & Belt Line

Lane Group	SBR
Lane Configurations	↑
Traffic Volume (vph)	66
Future Volume (vph)	66
Ideal Flow (vphpl)	1900
Storage Length (ft)	0
Storage Lanes	1
Taper Length (ft)	
Lane Util. Factor	0.95
Fr	0.850
Fit Protected	
Satd. Flow (prot)	1504
Fit Permitted	
Satd. Flow (perm)	1504
Right Turn on Red	Yes
Satd. Flow (RTOR)	89
Link Speed (mph)	
Link Distance (ft)	
Travel Time (s)	
Peak Hour Factor	0.95
Adj. Flow (vph)	69
Shared Lane Traffic (%)	49%
Lane Group Flow (vph)	35
Enter Blocked Intersection	No
Lane Alignment	Right
Median Width(ft)	
Link Offset(ft)	
Crosswalk Width(ft)	
Two way Left Turn Lane	
Headway Factor	1.00
Turning Speed (mph)	9
Number of Detectors	1
Detector Template	
Leading Detector (ft)	50
Trailing Detector (ft)	0
Detector 1 Position(ft)	0
Detector 1 Size(ft)	50
Detector 1 Type	Cl+Ex
Detector 1 Channel	
Detector 1 Extend (s)	0.0
Detector 1 Queue (s)	0.0
Detector 1 Delay (s)	0.0
Turn Type	custom
Protected Phases	
Permitted Phases	1 4
Detector Phase	1 4
Switch Phase	
Minimum Initial (s)	
Minimum Split (s)	
Total Split (s)	

Pepper Square TIA  
Lanes, Volumes, Timings

Phase 1, P, & N - 2033 Background + Site - AM  
1405: Prestonwood & Belt Line

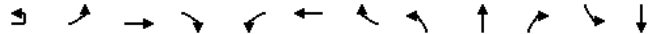

Lane Group	EBU	EBL	EBT	EBR	WBL	WBT	WBR	NBL	NBT	NBR	SBL	SBT
Total Split (%)	9.4%	9.4%	68.1%		9.4%	68.1%		11.3%	11.3%		11.3%	11.3%
Maximum Green (s)	10.0	10.0	103.0		10.0	103.0		13.0	13.0		12.8	12.8
Yellow Time (s)	3.0	3.0	4.5		3.0	4.5		3.0	3.0		3.2	3.2
All-Red Time (s)	2.0	2.0	1.5		2.0	1.5		2.0	2.0		2.0	2.0
Lost Time Adjust (s)		-1.0	-2.0		-1.0	-2.0		-1.0	-1.2		-1.2	-1.2
Total Lost Time (s)		4.0	4.0		4.0	4.0		4.0	4.0		4.0	4.0
Lead/Lag	Lag	Lag	Lag		Lead	Lead		Lead	Lead		Lag	Lag
Lead-Lag Optimize?	Yes	Yes	Yes		Yes	Yes		Yes	Yes		Yes	Yes
Vehicle Extension (s)	1.0	1.0	2.5		1.0	2.5		1.5	1.5		1.5	1.5
Recall Mode	None	None	C-Max		None	Max		None	None		None	None
Walk Time (s)			5.0			4.0		4.0	4.0		4.0	4.0
Flash Dont Walk (s)			10.0			14.0		14.0	14.0		14.0	14.0
Pedestrian Calls (#/hr)			0			0		0	0		0	0
Act Effect Green (s)		141.7	143.1		143.3	132.9		6.0	8.4		8.4	8.4
Actuated g/C Ratio		0.89	0.89		0.90	0.83		0.04	0.05		0.05	0.05
v/c Ratio		0.19	0.20		0.01	0.44		0.03	0.23		0.32	0.32
Control Delay		6.3	1.6		0.8	1.8		0.3	76.0		29.7	29.7
Queue Delay		0.0	0.0		0.0	0.0		0.0	0.0		0.0	0.0
Total Delay		6.3	1.6		0.8	1.8		0.3	76.0		29.7	29.7
LOS		A	A		A	A		A	E		C	C
Approach Delay			1.8			1.8		0.3				38.1
Approach LOS			A			A		A				D
Queue Length 50th (ft)		3	26		0	62		0	22		1	1
Queue Length 95th (ft)		17	71		m1	m83		0	44		42	42
Internal Link Dist (ft)			1365			1956		235				788
Turn Bay Length (ft)		200			200				300			
Base Capacity (vph)		268	4548		575	4206		262	300		163	163
Starvation Cap Reductn		0	0		0	0		0	0		0	0
Spillback Cap Reductn		0	0		0	0		0	0		0	0
Storage Cap Reductn		0	0		0	0		0	0		0	0
Reduced v/c Ratio		0.18	0.20		0.01	0.44		0.02	0.14		0.21	0.21

Intersection Summary

Area Type: Other  
 Cycle Length: 160  
 Actuated Cycle Length: 160  
 Offset: 73 (46%), Referenced to phase 6:EBWB, Start of Yellow  
 Natural Cycle: 90  
 Control Type: Actuated-Coordinated  
 Maximum v/c Ratio: 0.44  
 Intersection Signal Delay: 3.2 Intersection LOS: A  
 Intersection Capacity Utilization 55.7% ICU Level of Service B  
 Analysis Period (min) 15  
 m Volume for 95th percentile queue is metered by upstream signal.

Splits and Phases: 1405: Prestonwood & Belt Line



Pepper Square TIA  
Lanes, Volumes, Timings

Phase 1, P, & N - 2033 Background + Site - AM  
1405: Prestonwood & Belt Line



Lane Group	SBR
Total Split (%)	11.3%
Maximum Green (s)	12.8
Yellow Time (s)	3.2
All-Red Time (s)	2.0
Lost Time Adjust (s)	-1.2
Total Lost Time (s)	4.0
Lead/Lag	Lag
Lead-Lag Optimize?	Yes
Vehicle Extension (s)	1.5
Recall Mode	None
Walk Time (s)	4.0
Flash Dont Walk (s)	14.0
Pedestrian Calls (#/hr)	0
Act Effect Green (s)	20.5
Actuated g/C Ratio	0.13
v/c Ratio	0.13
Control Delay	1.0
Queue Delay	0.0
Total Delay	1.0
LOS	A
Approach Delay	
Approach LOS	
Queue Length 50th (ft)	0
Queue Length 95th (ft)	0
Internal Link Dist (ft)	
Turn Bay Length (ft)	
Base Capacity (vph)	338
Starvation Cap Reductn	0
Spillback Cap Reductn	0
Storage Cap Reductn	0
Reduced v/c Ratio	0.10

Intersection Summary

Area Type: Other  
 Cycle Length: 160  
 Actuated Cycle Length: 160  
 Offset: 73 (46%), Referenced to phase 6:EBWB, Start of Yellow  
 Natural Cycle: 90  
 Control Type: Actuated-Coordinated  
 Maximum v/c Ratio: 0.44  
 Intersection Signal Delay: 3.2 Intersection LOS: A  
 Intersection Capacity Utilization 55.7% ICU Level of Service B  
 Analysis Period (min) 15  
 m Volume for 95th percentile queue is metered by upstream signal.

Splits and Phases: 1405: Prestonwood & Belt Line

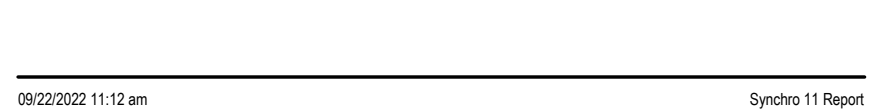

Pepper Square TIA  
HCM 6th TWSC

Phase 1, P, & N - 2033 Background + Site - AM  
2: Ladera Drive & Belt Line

Intersection													
Int Delay, s/veh	46												
Movement	EBL	EBT	EBR	WBL	WBT	WBR	NBL	NBT	NBR	SBL	SBT	SBR	
Lane Configurations	↔ ↑↑↑			↔ ↑↑↑			↑			↔ ↑			
Traffic Vol, veh/h	71	833	16	23	1533	43	42	0	67	83	0	151	
Future Vol, veh/h	71	833	16	23	1533	43	42	0	67	83	0	151	
Conflicting Peds, #/hr	0	0	0	0	0	0	0	0	0	0	0	0	
Sign Control	Free	Free	Free	Free	Free	Stop	Stop	Stop	Stop	Stop	Stop	Stop	
RT Channelized	-	-	None	-	-	None	-	-	None	-	-	None	
Storage Length	100	-	-	100	-	-	-	-	0	-	-	0	
Veh in Median Storage, #	-	0	-	-	0	-	-	1	-	-	1	-	
Grade, %	-	0	-	-	0	-	-	0	-	-	0	-	
Peak Hour Factor	91	91	91	91	91	91	91	91	91	91	91	91	
Heavy Vehicles, %	2	2	2	2	2	2	2	2	2	2	2	2	
Mvmt Flow	78	915	18	25	1685	47	46	0	74	91	0	166	

Major/Minor	Major1	Major2	Minor1	Minor2	
Conflicting Flow All	1732	0	0	933	0
Stage 1	-	-	-	-	1080
Stage 2	-	-	-	-	724
Critical Hdwy	5.34	-	-	5.34	-
Critical Hdwy Stg 1	-	-	-	-	7.34
Critical Hdwy Stg 2	-	-	-	-	6.74
Follow-up Hdwy	3.12	-	-	3.12	-
Pot Cap-1 Maneuver	171	-	-	875	-
Stage 1	-	-	-	-	528
Stage 2	-	-	-	-	348
Platoon blocked, %	-	-	-	1	-
Mov Cap-1 Maneuver	171	-	-	875	-
Mov Cap-2 Maneuver	-	-	-	-	36
Stage 1	-	-	-	-	287
Stage 2	-	-	-	-	118

Approach	EB	WB	NB	SB
HCM Control Delay, s	3.3	0.1	167	\$ 470.9
HCM LOS			F	F

Minor Lane/Major Mvmt	NBLn1	NBLn2	EBL	EBT	EBR	WBL	WBT	WBR	SBLn1	SBLn2
Capacity (veh/h)	36	736	171	-	-	875	-	-	29	255
HCM Lane V/C Ratio	1.282	0.1	0.456	-	-	0.029	-	-	3.145	0.651
HCM Control Delay (s)	\$ 416.9	10.4	42.6	-	-	9.2	-	-	\$ 1251	42.1
HCM Lane LOS	F	B	E	-	-	A	-	-	F	E
HCM 95th %tile Q(veh)	4.8	0.3	2.1	-	-	0.1	-	-	10.9	4.1

Notes  
 ~: Volume exceeds capacity    \$: Delay exceeds 300s    +: Computation Not Defined    \*: All major volume in platoon

Pepper Square TIA  
HCM 6th TWSC

Phase 1, P, & N - 2033 Background + Site - AM  
3: Median Opening East of Preston Rd & Belt Line

Intersection													
Int Delay, s/veh	0.7												
Movement	EBU	EBL	EBT	EBR	WBL	WBT	WBR	NBL	NBT	NBR	SBL	SBT	SBR
Lane Configurations	↔ ↑↑↑			↔ ↑↑↑			↔			↔			
Traffic Vol, veh/h	4	21	632	30	30	1212	18	10	2	44	1	0	3
Future Vol, veh/h	4	21	632	30	30	1212	18	10	2	44	1	0	3
Conflicting Peds, #/hr	0	0	0	0	0	0	0	0	0	0	0	0	0
Sign Control	Free	Free	Free	Free	Free	Free	Stop	Stop	Stop	Stop	Stop	Stop	Stop
RT Channelized	-	-	-	None	-	-	None	-	-	None	-	-	None
Storage Length	-	150	-	-	200	-	-	-	-	-	-	-	-
Veh in Median Storage, #	-	-	0	-	0	-	-	1	-	-	1	-	-
Grade, %	-	-	0	-	0	-	-	0	-	-	0	-	-
Peak Hour Factor	96	96	96	96	96	96	96	96	96	96	96	96	96
Heavy Vehicles, %	2	2	2	2	2	2	2	2	2	2	2	2	2
Mvmt Flow	4	22	658	31	31	1263	19	10	2	46	1	0	3

Major/Minor	Major1	Major2	Minor1	Minor2	
Conflicting Flow All	935	1282	0	0	689
Stage 1	-	-	-	-	726
Stage 2	-	-	-	-	567
Critical Hdwy	5.64	5.34	-	-	5.34
Critical Hdwy Stg 1	-	-	-	-	7.34
Critical Hdwy Stg 2	-	-	-	-	6.74
Follow-up Hdwy	2.32	3.12	-	-	3.12
Pot Cap-1 Maneuver	*1079	*803	-	-	551
Stage 1	-	-	-	-	308
Stage 2	-	-	-	-	655
Platoon blocked, %	1	1	-	-	1
Mov Cap-1 Maneuver	*837	*837	-	-	551
Mov Cap-2 Maneuver	-	-	-	-	539
Stage 1	-	-	-	-	298
Stage 2	-	-	-	-	615

Approach	EB	WB	NB	SB
HCM Control Delay, s	0.3	0.3	12.6	11.5
HCM LOS			B	B

Minor Lane/Major Mvmt	NBLn1	EBL	EBT	EBR	WBL	WBT	WBR	SBLn1
Capacity (veh/h)	535	* 837	-	-	551	-	-	559
HCM Lane V/C Ratio	0.109	0.031	-	-	0.057	-	-	0.007
HCM Control Delay (s)	12.6	9.4	-	-	11.9	-	-	11.5
HCM Lane LOS	B	A	-	-	B	-	-	B
HCM 95th %tile Q(veh)	0.4	0.1	-	-	0.2	-	-	0

Notes  
 ~: Volume exceeds capacity    \$: Delay exceeds 300s    +: Computation Not Defined    \*: All major volume in platoon

Pepper Square TIA  
HCM 6th TWSC

Phase 1, P, & N - 2033 Background + Site - AM  
5: Belt Line & Median between Berry Trail and Alexis Dr

Intersection												
Int Delay, s/veh	0.6											
Movement	EBL	EBT	EBR	WBL	WBT	WBR	NBL	NBT	NBR	SBL	SBT	SBR
Lane Configurations	↔ ↗ ↘			↔ ↗ ↘			↔			↔		
Traffic Vol, veh/h	5	712	26	44	1171	12	14	0	44	6	1	7
Future Vol, veh/h	5	712	26	44	1171	12	14	0	44	6	1	7
Conflicting Peds, #/hr	0	0	0	0	0	0	0	0	0	0	0	0
Sign Control	Free	Free	Free	Free	Free	Stop	Stop	Stop	Stop	Stop	Stop	Stop
RT Channelized	-	-	None	-	-	None	-	-	None	-	-	None
Storage Length	150	-	-	150	-	-	-	-	-	-	-	-
Veh in Median Storage, #	-	0	-	-	0	-	-	1	-	-	1	-
Grade, %	-	0	-	-	0	-	-	0	-	-	0	-
Peak Hour Factor	88	88	88	88	88	88	88	88	88	88	88	88
Heavy Vehicles, %	2	2	2	2	2	2	2	2	2	2	2	2
Mvmt Flow	6	809	30	50	1331	14	16	0	50	7	1	8

Major/Minor	Major1	Major2	Minor1	Minor2
Conflicting Flow All	1345	0	0	839
Stage 1	-	-	-	-
Stage 2	-	-	-	-
Critical Hdwy	5.34	-	-	5.34
Critical Hdwy Stg 1	-	-	-	-
Critical Hdwy Stg 2	-	-	-	-
Follow-up Hdwy	3.12	-	-	3.12
Pot Cap-1 Maneuver	757	-	-	844
Stage 1	-	-	-	-
Stage 2	-	-	-	-
Platoon blocked, %	1	-	-	1
Mov Cap-1 Maneuver	757	-	-	844
Mov Cap-2 Maneuver	-	-	-	-
Stage 1	-	-	-	-
Stage 2	-	-	-	-

Approach	EB	WB	NB	SB
HCM Control Delay, s	0.1	0.3	10.7	12.3
HCM LOS			B	B

Minor Lane/Major Mvmt	NBLn1	EBL	EBT	EBR	WBL	WBT	WBR	SBLn1
Capacity (veh/h)	692	757	-	-	844	-	-	512
HCM Lane V/C Ratio	0.095	0.008	-	-	0.059	-	-	0.031
HCM Control Delay (s)	10.7	9.8	-	-	9.5	-	-	12.3
HCM Lane LOS	B	A	-	-	A	-	-	B
HCM 95th %tile Q(veh)	0.3	0	-	-	0.2	-	-	0.1

Notes  
 ~: Volume exceeds capacity    \$: Delay exceeds 300s    +: Computation Not Defined    \*: All major volume in platoon

Pepper Square TIA  
HCM 6th TWSC

Phase 1, P, & N - 2033 Background + Site - AM  
6: Alexis Drive & Belt Line

Intersection						
Int Delay, s/veh	2.2					
Movement	EBT	EBR	WBL	WBT	NBL	NBR
Lane Configurations	↔ ↗		↔ ↗		↔ ↗	
Traffic Vol, veh/h	749	7	176	1186	24	246
Future Vol, veh/h	749	7	176	1186	24	246
Conflicting Peds, #/hr	0	0	0	0	0	0
Sign Control	Free	Free	Free	Free	Stop	Stop
RT Channelized	-	None	-	None	-	Yield
Storage Length	-	-	150	-	0	0
Veh in Median Storage, #	0	-	-	0	1	-
Grade, %	0	-	-	0	0	-
Peak Hour Factor	86	86	86	86	86	86
Heavy Vehicles, %	2	2	2	2	2	2
Mvmt Flow	871	8	205	1379	28	286

Major/Minor	Major1	Major2	Minor1
Conflicting Flow All	0	0	879
Stage 1	-	-	-
Stage 2	-	-	-
Critical Hdwy	-	-	5.34
Critical Hdwy Stg 1	-	-	-
Critical Hdwy Stg 2	-	-	-
Follow-up Hdwy	-	-	3.12
Pot Cap-1 Maneuver	-	-	867
Stage 1	-	-	-
Stage 2	-	-	-
Platoon blocked, %	-	-	1
Mov Cap-1 Maneuver	-	-	867
Mov Cap-2 Maneuver	-	-	-
Stage 1	-	-	-
Stage 2	-	-	-

Approach	EB	WB	NB
HCM Control Delay, s	0	1.3	12.8
HCM LOS			B

Minor Lane/Major Mvmt	NBLn1	NBLn2	EBT	EBR	WBL	WBT
Capacity (veh/h)	434	752	-	-	867	-
HCM Lane V/C Ratio	0.064	0.38	-	-	0.236	-
HCM Control Delay (s)	13.9	12.7	-	-	10.4	-
HCM Lane LOS	B	B	-	-	B	-
HCM 95th %tile Q(veh)	0.2	1.8	-	-	0.9	-

Notes  
 ~: Volume exceeds capacity    \$: Delay exceeds 300s    +: Computation Not Defined    \*: All major volume in platoon



Pepper Square TIA  
HCM 6th TWSC

Phase 1, P, & N - 2033 Background + Site - AM  
10: Preston & Pepper Square Driveway

Intersection														
Int Delay, s/veh	2.1													
Movement	EBL	EBT	EBR	WBL	WBT	WBR	NBU	NBL	NBT	NBR	SBU	SBL	SBT	SBR
Lane Configurations		↔			↔	↔			↔	↔			↔	↔
Traffic Vol, veh/h	11	3	27	7	1	43	1	53	2098	48	1	16	2258	70
Future Vol, veh/h	11	3	27	7	1	43	1	53	2098	48	1	16	2258	70
Conflicting Peds, #/hr	0	0	0	0	0	0	0	0	0	0	0	0	0	0
Sign Control	Stop	Stop	Stop	Stop	Stop	Free	Free	Free	Free	Free	Free	Free	Free	Free
RT Channelized	-	-	None	-	-	None	-	-	None	-	-	-	-	None
Storage Length	-	-	-	-	-	0	-	150	-	-	-	150	-	-
Veh in Median Storage, #	-	1	-	-	1	-	-	-	0	-	-	-	0	-
Grade, %	-	0	-	-	0	-	-	-	0	-	-	-	0	-
Peak Hour Factor	89	89	89	89	89	89	89	89	89	89	89	89	89	89
Heavy Vehicles, %	2	2	2	2	2	2	2	2	2	2	2	2	2	2
Mvmt Flow	12	3	30	8	1	48	1	60	2357	54	1	18	2537	79

Major/Minor	Minor2	Minor1	Major1	Major2
Conflicting Flow All	3680	5148	1308	3560
Stage 1	2615	2615	-	2506
Stage 2	1065	2533	-	1054
Critical Hdwy	6.44	6.54	7.14	6.44
Critical Hdwy Stg 1	7.34	5.54	-	7.34
Critical Hdwy Stg 2	6.74	5.54	-	6.74
Follow-up Hdwy	3.82	4.02	3.92	3.82
Pot Cap-1 Maneuver	~12	0	*396	*17
Stage 1	334	340	-	*16
Stage 2	214	55	-	*406
Platoon blocked, %	1	1	1	1
Mov Cap-1 Maneuver	~6	0	*396	*12
Mov Cap-2 Maneuver	71	23	-	*13
Stage 1	287	258	-	*14
Stage 2	122	47	-	*281

Approach	EB	WB	NB	SB
HCM Control Delay, s	55.1	106.5	0.4	0.5
HCM LOS	F	F		

Minor Lane/Major Mvmt	NBL	NBT	NBR	EBLn1	WBLn1	WBLn2	SBL	SBT	SBR
Capacity (veh/h)	435	-	-	116	14	151	79	-	-
HCM Lane V/C Ratio	0.139	-	-	0.397	0.642	0.32	0.242	-	-
HCM Control Delay (s)	14.6	-	-	55.1\$	465.8	39.7	64.9	-	-
HCM Lane LOS	B	-	-	F	F	E	F	-	-
HCM 95th %tile Q(veh)	0.5	-	-	1.7	1.5	1.3	0.9	-	-

Notes  
 ~: Volume exceeds capacity    \$: Delay exceeds 300s    +: Computation Not Defined    \*: All major volume in platoon

Pepper Square TIA  
HCM 6th TWSC

Phase 1, P, & N - 2033 Background + Site - AM  
20: Preston & Drive 2

Intersection						
Int Delay, s/veh	0.3					
Movement	WBL	WBR	NBT	NBR	SBL	SBT
Lane Configurations		↔	↔	↔		↔
Traffic Vol, veh/h	0	37	2082	29	0	2351
Future Vol, veh/h	0	37	2082	29	0	2351
Conflicting Peds, #/hr	0	0	0	0	0	0
Sign Control	Stop	Stop	Free	Free	Free	Free
RT Channelized	-	None	-	None	-	None
Storage Length	-	0	-	-	-	-
Veh in Median Storage, #	0	-	0	-	-	0
Grade, %	0	-	0	-	-	0
Peak Hour Factor	92	92	92	92	92	92
Heavy Vehicles, %	2	2	2	2	2	2
Mvmt Flow	0	40	2263	32	0	2555

Major/Minor	Minor1	Major1	Major2
Conflicting Flow All	-	1148	0
Stage 1	-	-	-
Stage 2	-	-	-
Critical Hdwy	-	7.14	-
Critical Hdwy Stg 1	-	-	-
Critical Hdwy Stg 2	-	-	-
Follow-up Hdwy	-	3.92	-
Pot Cap-1 Maneuver	0	165	-
Stage 1	0	-	-
Stage 2	0	-	-
Platoon blocked, %	-	-	-
Mov Cap-1 Maneuver	-	165	-
Mov Cap-2 Maneuver	-	-	-
Stage 1	-	-	-
Stage 2	-	-	-

Approach	WB	NB	SB
HCM Control Delay, s	33.7	0	0
HCM LOS	D		

Minor Lane/Major Mvmt	NBT	NBR	WBLn1	SBT
Capacity (veh/h)	-	-	165	-
HCM Lane V/C Ratio	-	-	0.244	-
HCM Control Delay (s)	-	-	33.7	-
HCM Lane LOS	-	-	D	-
HCM 95th %tile Q(veh)	-	-	0.9	-

Pepper Square TIA  
HCM 6th TWSC

Phase 1, P, & N - 2033 Background + Site - AM  
21: Preston & Drive 1

Intersection						
Int Delay, s/veh	0					
Movement	WBL	WBR	NBT	NBR	SBL	SBT
Lane Configurations		↑↑↑	↑↑↑			↑↑↑
Traffic Vol, veh/h	0	0	2201	0	0	2291
Future Vol, veh/h	0	0	2201	0	0	2291
Conflicting Peds, #/hr	0	0	0	0	0	0
Sign Control	Stop	Stop	Free	Free	Free	Free
RT Channelized	-	None	-	None	-	None
Storage Length	-	0	-	-	-	-
Veh in Median Storage, #	0	-	0	-	0	0
Grade, %	0	-	0	-	0	0
Peak Hour Factor	92	92	92	92	92	92
Heavy Vehicles, %	2	2	2	2	2	2
Mvmt Flow	0	0	2392	0	0	2490

Major/Minor	Minor1	Major1	Major2		
Conflicting Flow All	-	1196	0	0	-
Stage 1	-	-	-	-	-
Stage 2	-	-	-	-	-
Critical Hdwy	-	7.14	-	-	-
Critical Hdwy Stg 1	-	-	-	-	-
Critical Hdwy Stg 2	-	-	-	-	-
Follow-up Hdwy	-	3.92	-	-	-
Pot Cap-1 Maneuver	0	153	-	0	-
Stage 1	0	-	-	0	-
Stage 2	0	-	-	0	-
Platoon blocked, %	-	-	-	-	-
Mov Cap-1 Maneuver	-	153	-	-	-
Mov Cap-2 Maneuver	-	-	-	-	-
Stage 1	-	-	-	-	-
Stage 2	-	-	-	-	-

Approach	WB	NB	SB
HCM Control Delay, s	0	0	0
HCM LOS	A		

Minor Lane/Major Mvmt	NBT	NBRWBLn1	SBT
Capacity (veh/h)	-	-	-
HCM Lane V/C Ratio	-	-	-
HCM Control Delay (s)	-	0	-
HCM Lane LOS	-	A	-
HCM 95th %tile Q(veh)	-	-	-

Pepper Square TIA  
HCM 6th TWSC

Phase 1, P, & N - 2033 Background + Site - AM  
22: Drive 6 & Belt Line

Intersection						
Int Delay, s/veh	0.3					
Movement	EBT	EBR	WBL	WBT	NBL	NBR
Lane Configurations	↑↑↑			↑↑↑		↑
Traffic Vol, veh/h	645	26	0	1267	0	44
Future Vol, veh/h	645	26	0	1267	0	44
Conflicting Peds, #/hr	0	0	0	0	0	0
Sign Control	Free	Free	Free	Free	Stop	Stop
RT Channelized	-	None	-	None	-	None
Storage Length	-	-	-	-	-	0
Veh in Median Storage, #	0	-	-	0	0	-
Grade, %	0	-	-	0	0	-
Peak Hour Factor	96	96	96	96	96	96
Heavy Vehicles, %	2	2	2	2	2	2
Mvmt Flow	672	27	0	1320	0	46

Major/Minor	Major1	Major2	Minor1		
Conflicting Flow All	0	0	-	-	350
Stage 1	-	-	-	-	-
Stage 2	-	-	-	-	-
Critical Hdwy	-	-	-	-	7.14
Critical Hdwy Stg 1	-	-	-	-	-
Critical Hdwy Stg 2	-	-	-	-	-
Follow-up Hdwy	-	-	-	-	3.92
Pot Cap-1 Maneuver	-	-	0	-	552
Stage 1	-	-	0	-	0
Stage 2	-	-	0	-	0
Platoon blocked, %	-	-	-	-	-
Mov Cap-1 Maneuver	-	-	-	-	552
Mov Cap-2 Maneuver	-	-	-	-	-
Stage 1	-	-	-	-	-
Stage 2	-	-	-	-	-

Approach	EB	WB	NB
HCM Control Delay, s	0	0	12.1
HCM LOS			B

Minor Lane/Major Mvmt	NBLn1	EBT	EBR	WBT
Capacity (veh/h)	552	-	-	-
HCM Lane V/C Ratio	0.083	-	-	-
HCM Control Delay (s)	12.1	-	-	-
HCM Lane LOS	B	-	-	-
HCM 95th %tile Q(veh)	0.3	-	-	-

Pepper Square TIA  
HCM 6th TWSC

Phase 1, P, & N - 2033 Background + Site - AM  
24: Drive 5 & Belt Line

Intersection						
Int Delay, s/veh	0.3					
Movement	EBT	EBR	WBL	WBT	NBL	NBR
Lane Configurations	↑↑↑			↑↑↑		↑
Traffic Vol, veh/h	650	26	0	1210	0	44
Future Vol, veh/h	650	26	0	1210	0	44
Conflicting Peds, #/hr	0	0	0	0	0	0
Sign Control	Free	Free	Free	Free	Stop	Stop
RT Channelized	-	None	-	None	-	None
Storage Length	-	-	-	-	-	0
Veh in Median Storage, #	0	-	-	0	0	-
Grade, %	0	-	-	0	0	-
Peak Hour Factor	96	96	96	96	96	96
Heavy Vehicles, %	2	2	2	2	2	2
Mvmt Flow	677	27	0	1260	0	46

Major/Minor	Major1	Major2	Minor1
Conflicting Flow All	0	0	- 352
Stage 1	-	-	-
Stage 2	-	-	-
Critical Hdwy	-	-	- 7.14
Critical Hdwy Stg 1	-	-	-
Critical Hdwy Stg 2	-	-	-
Follow-up Hdwy	-	-	- 3.92
Pot Cap-1 Maneuver	-	0	- 0 550
Stage 1	-	0	- 0
Stage 2	-	0	- 0
Platoon blocked, %	-	-	-
Mov Cap-1 Maneuver	-	-	- 550
Mov Cap-2 Maneuver	-	-	-
Stage 1	-	-	-
Stage 2	-	-	-

Approach	EB	WB	NB
HCM Control Delay, s	0	0	12.1
HCM LOS			B

Minor Lane/Major Mvmt	NBLn1	EBT	EBR	WBT
Capacity (veh/h)	550	-	-	-
HCM Lane V/C Ratio	0.083	-	-	-
HCM Control Delay (s)	12.1	-	-	-
HCM Lane LOS	B	-	-	-
HCM 95th %tile Q(veh)	0.3	-	-	-

Pepper Square TIA  
HCM 6th TWSC

Phase 1, P, & N - 2033 Background + Site - AM  
25: Preston & Drive 4

Intersection						
Int Delay, s/veh	0.3					
Movement	WBL	WBR	NBT	NBR	SBL	SBT
Lane Configurations		↑↑↑	↑↑↑			↑↑↑
Traffic Vol, veh/h	0	36	2126	29	0	2333
Future Vol, veh/h	0	36	2126	29	0	2333
Conflicting Peds, #/hr	0	0	0	0	0	0
Sign Control	Stop	Stop	Free	Free	Free	Free
RT Channelized	-	None	-	None	-	None
Storage Length	-	0	-	-	-	-
Veh in Median Storage, #	0	-	0	-	-	0
Grade, %	0	-	0	-	-	0
Peak Hour Factor	92	92	92	92	92	92
Heavy Vehicles, %	2	2	2	2	2	2
Mvmt Flow	0	39	2311	32	0	2536

Major/Minor	Minor1	Major1	Major2
Conflicting Flow All	- 1172	0	0 -
Stage 1	-	-	-
Stage 2	-	-	-
Critical Hdwy	- 7.14	-	-
Critical Hdwy Stg 1	-	-	-
Critical Hdwy Stg 2	-	-	-
Follow-up Hdwy	- 3.92	-	-
Pot Cap-1 Maneuver	0 159	-	- 0 -
Stage 1	0	-	- 0 -
Stage 2	0	-	- 0 -
Platoon blocked, %	-	-	-
Mov Cap-1 Maneuver	- 159	-	-
Mov Cap-2 Maneuver	-	-	-
Stage 1	-	-	-
Stage 2	-	-	-

Approach	WB	NB	SB
HCM Control Delay, s	34.9	0	0
HCM LOS	D		

Minor Lane/Major Mvmt	NBT	NBRWBLn1	SBT
Capacity (veh/h)	-	- 159	-
HCM Lane V/C Ratio	-	- 0.246	-
HCM Control Delay (s)	-	- 34.9	-
HCM Lane LOS	-	- D	-
HCM 95th %tile Q(veh)	-	- 0.9	-

Intersection						
Int Delay, s/veh	0.3					
Movement	WBL	WBR	NBT	NBR	SBL	SBT
Lane Configurations			↑ ↑ ↑			↑ ↑ ↑
Traffic Vol, veh/h	0	34	2127	29	0	2333
Future Vol, veh/h	0	34	2127	29	0	2333
Conflicting Peds, #/hr	0	0	0	0	0	0
Sign Control	Stop	Stop	Free	Free	Free	Free
RT Channelized	-	None	-	None	-	None
Storage Length	-	0	-	-	-	-
Veh in Median Storage, #	0	-	0	-	-	0
Grade, %	0	-	0	-	-	0
Peak Hour Factor	92	92	92	92	92	92
Heavy Vehicles, %	2	2	2	2	2	2
Mvmt Flow	0	37	2312	32	0	2536

Major/Minor	Minor1	Major1	Major2		
Conflicting Flow All	-	1172	0	0	-
Stage 1	-	-	-	-	-
Stage 2	-	-	-	-	-
Critical Hdwy	-	7.14	-	-	-
Critical Hdwy Stg 1	-	-	-	-	-
Critical Hdwy Stg 2	-	-	-	-	-
Follow-up Hdwy	-	3.92	-	-	-
Pot Cap-1 Maneuver	0	159	-	-	0
Stage 1	0	-	-	-	0
Stage 2	0	-	-	-	0
Platoon blocked, %	-	-	-	-	-
Mov Cap-1 Maneuver	-	159	-	-	-
Mov Cap-2 Maneuver	-	-	-	-	-
Stage 1	-	-	-	-	-
Stage 2	-	-	-	-	-

Approach	WB	NB	SB
HCM Control Delay, s	34.4	0	0
HCM LOS	D		

Minor Lane/Major Mvmt	NBT	NBRWBLn1	SBT
Capacity (veh/h)	-	-	159
HCM Lane V/C Ratio	-	-	0.232
HCM Control Delay (s)	-	-	34.4
HCM Lane LOS	-	-	D
HCM 95th %tile Q(veh)	-	-	0.9

Pepper Square TIA  
Lanes, Volumes, Timings

Phase 1, P, & N - 2033 Background + Site - PM  
4: Berry Trail & Belt Line

Lane Group	EBL	EBT	EBR	WBL	WBT	WBR	NBL	NBT	NBR	SBL	SBT	SBR
Lane Configurations	↔	↔↔↔		↔	↔↔↔		↔	↔		↔	↔	
Traffic Volume (vph)	41	1288	71	127	906	33	115	10	60	28	6	35
Future Volume (vph)	41	1288	71	127	906	33	115	10	60	28	6	35
Ideal Flow (vphpl)	1900	1900	1900	1900	1900	1900	1900	1900	1900	1900	1900	1900
Storage Length (ft)	150		0	150		0	0		0	0		0
Storage Lanes	1		0	1		0	1		0	1		0
Taper Length (ft)	25			25			25			25		
Lane Util. Factor	1.00	0.91	0.91	1.00	0.91	0.91	1.00	1.00	1.00	1.00	1.00	1.00
Frt		0.992			0.995			0.872			0.871	
Fit Protected	0.950			0.950			0.950			0.950		
Satd. Flow (prot)	1770	5045	0	1770	5060	0	1770	1624	0	1770	1622	0
Fit Permitted	0.262			0.151			0.909			0.681		
Satd. Flow (perm)	488	5045	0	281	5060	0	1693	1624	0	1269	1622	0
Right Turn on Red			Yes			Yes			Yes			Yes
Satd. Flow (RTOR)		9			6			64				37
Link Speed (mph)	42			42			30			30		
Link Distance (ft)	234			493			277			236		
Travel Time (s)	3.8			8.0			6.3			5.4		
Peak Hour Factor	0.94	0.94	0.94	0.94	0.94	0.94	0.94	0.94	0.94	0.94	0.94	0.94
Adj. Flow (vph)	44	1370	76	135	964	35	122	11	64	30	6	37
Shared Lane Traffic (%)												
Lane Group Flow (vph)	44	1446	0	135	999	0	122	75	0	30	43	0
Enter Blocked Intersection	No	No	No	No	No	No	No	No	No	No	No	No
Lane Alignment	Left	Left	Right	Left	Left	Right	Left	Left	Right	Left	Left	Right
Median Width(ft)	12			12			12			12		
Link Offset(ft)	0			0			0			0		
Crosswalk Width(ft)	16			16			16			16		
Two way Left Turn Lane												
Headway Factor	1.00	1.00	1.00	1.00	1.00	1.00	1.00	1.00	1.00	1.00	1.00	1.00
Turning Speed (mph)	15		9	15		9	15		9	15		9
Number of Detectors	1	2		1	2		1	2		1	2	
Detector Template	Left	Thru		Left	Thru		Left	Thru		Left	Thru	
Leading Detector (ft)	20	100		20	100		20	100		20	100	
Trailing Detector (ft)	0	0		0	0		0	0		0	0	
Detector 1 Position(ft)	0	0		0	0		0	0		0	0	
Detector 1 Size(ft)	20	6		20	6		20	6		20	6	
Detector 1 Type	Cl+Ex	Cl+Ex		Cl+Ex	Cl+Ex		Cl+Ex	Cl+Ex		Cl+Ex	Cl+Ex	
Detector 1 Channel												
Detector 1 Extend (s)	0.0	0.0		0.0	0.0		0.0	0.0		0.0	0.0	
Detector 1 Queue (s)	0.0	0.0		0.0	0.0		0.0	0.0		0.0	0.0	
Detector 1 Delay (s)	0.0	0.0		0.0	0.0		0.0	0.0		0.0	0.0	
Detector 2 Position(ft)		94			94			94			94	
Detector 2 Size(ft)		6			6			6			6	
Detector 2 Type		Cl+Ex			Cl+Ex			Cl+Ex			Cl+Ex	
Detector 2 Channel												
Detector 2 Extend (s)		0.0			0.0			0.0			0.0	
Turn Type	D,P+P	NA		D,P+P	NA		D,P+P	NA		D,P+P	NA	
Protected Phases	3	8		7	4		1	6		5	2	
Permitted Phases	4			8			2			6		

Pepper Square TIA  
Lanes, Volumes, Timings

Phase 1, P, & N - 2033 Background + Site - PM  
4: Berry Trail & Belt Line

Lane Group	EBL	EBT	EBR	WBL	WBT	WBR	NBL	NBT	NBR	SBL	SBT	SBR
Detector Phase	3	8		7	4		1	6		5	2	
Switch Phase												
Minimum Initial (s)	4.0	4.0		4.0	4.0		4.0	4.0		4.0	4.0	
Minimum Split (s)	10.0	24.0		10.0	24.0		10.0	31.0		10.0	31.0	
Total Split (s)	15.0	99.0		15.0	99.0		20.0	31.0		15.0	26.0	
Total Split (%)	9.4%	61.9%		9.4%	61.9%		12.5%	19.4%		9.4%	16.3%	
Maximum Green (s)	9.0	93.0		9.0	93.0		14.0	25.0		9.0	20.0	
Yellow Time (s)	4.0	4.0		4.0	4.0		4.0	4.0		4.0	4.0	
All-Red Time (s)	2.0	2.0		2.0	2.0		2.0	2.0		2.0	2.0	
Lost Time Adjust (s)	0.0	0.0		0.0	0.0		0.0	0.0		0.0	0.0	
Total Lost Time (s)	6.0	6.0		6.0	6.0		6.0	6.0		6.0	6.0	
Lead/Lag	Lead	Lag		Lead	Lag		Lead	Lag		Lead	Lag	
Lead-Lag Optimize?	Yes	Yes		Yes	Yes		Yes	Yes		Yes	Yes	
Vehicle Extension (s)	1.0	1.0		1.0	1.0		1.0	1.0		1.0	1.0	
Recall Mode	None	C-Max		None	C-Max		None	None		None	None	
Walk Time (s)		4.0			4.0			4.0			4.0	
Flash Dont Walk (s)		14.0			14.0			21.0			21.0	
Pedestrian Calls (#/hr)		0			0			0			0	
Act Effct Green (s)	121.8	114.0		120.6	118.0		16.6	11.5		16.6	5.2	
Actuated g/C Ratio	0.76	0.71		0.75	0.74		0.10	0.07		0.10	0.03	
v/c Ratio	0.11	0.40		0.50	0.27		0.67	0.43		0.20	0.49	
Control Delay	3.2	4.2		17.9	2.7		81.4	27.4		60.8	44.0	
Queue Delay	0.0	0.0		0.0	0.0		0.0	0.0		0.0	0.0	
Total Delay	3.2	4.2		17.9	2.7		81.4	27.4		60.8	44.0	
LOS	A	A		B	A		F	C		E	D	
Approach Delay		4.2			4.5			60.8			50.9	
Approach LOS		A			A			E			D	
Queue Length 50th (ft)	5	69		27	54		119	11		28	6	
Queue Length 95th (ft)	m6	m79		93	68		183	66		60	50	
Internal Link Dist (ft)		154			413			197			156	
Turn Bay Length (ft)	150			150								
Base Capacity (vph)	453	3598		299	3734		201	307		177	235	
Starvation Cap Reductn	0	0		0	0		0	0		0	0	
Spillback Cap Reductn	0	0		0	0		0	0		0	0	
Storage Cap Reductn	0	0		0	0		0	0		0	0	
Reduced v/c Ratio	0.10	0.40		0.45	0.27		0.61	0.24		0.17	0.18	

Intersection Summary

Area Type: Other  
 Cycle Length: 160  
 Actuated Cycle Length: 160  
 Offset: 153 (96%), Referenced to phase 4:EBWB and 8:EBWB, Start of Yellow  
 Natural Cycle: 80  
 Control Type: Actuated-Coordinated  
 Maximum v/c Ratio: 0.67  
 Intersection Signal Delay: 9.4  
 Intersection LOS: A  
 Intersection Capacity Utilization 61.5%  
 ICU Level of Service B  
 Analysis Period (min) 15  
 m Volume for 95th percentile queue is metered by upstream signal.

Pepper Square TIA  
Lanes, Volumes, Timings

Phase 1, P, & N - 2033 Background + Site - PM  
4: Berry Trail & Belt Line

Splits and Phases: 4: Berry Trail & Belt Line

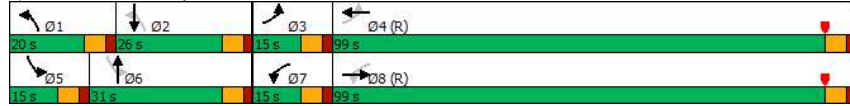

Pepper Square TIA  
Lanes, Volumes, Timings

Phase 1, P, & N - 2033 Background + Site - PM  
1335: Meadow Creek & Belt Line

	EBL	EBT	EBR	WBL	WBT	WBR	NBL	NBT	NBR	SBL	SBT	SBR
Lane Configurations	↑ ↑ ↑ ↑ ↓ ↓ ↓ ↓											
Traffic Volume (vph)	91	1541	46	7	1288	19	19	12	10	13	5	63
Future Volume (vph)	91	1541	46	7	1288	19	19	12	10	13	5	63
Ideal Flow (vphpl)	1900	1900	1900	1900	1900	1900	1900	1900	1900	1900	1900	1900
Storage Length (ft)	150		0	150		0	0		0	0		0
Storage Lanes	1		0	1		0	0		0	0		0
Taper Length (ft)	25			25			25			25		
Lane Util. Factor	1.00	0.91	0.91	1.00	0.91	0.91	1.00	1.00	1.00	1.00	1.00	1.00
Frt		0.996			0.998			0.966				0.895
Fit Protected	0.950			0.950				0.978				0.992
Satd. Flow (prot)	1770	5065	0	1770	5075	0	0	1760	0	0	1654	0
Fit Permitted	0.181			0.130				0.521				0.936
Satd. Flow (perm)	337	5065	0	242	5075	0	0	937	0	0	1560	0
Right Turn on Red			Yes			Yes			Yes			Yes
Satd. Flow (RTOR)		6			3			11				66
Link Speed (mph)	42				42			30				30
Link Distance (ft)		1673			2404			392				423
Travel Time (s)		27.2			39.0			8.9				9.6
Peak Hour Factor	0.95	0.95	0.95	0.95	0.95	0.95	0.95	0.95	0.95	0.95	0.95	0.95
Adj. Flow (vph)	96	1622	48	7	1356	20	20	13	11	14	5	66
Shared Lane Traffic (%)												
Lane Group Flow (vph)	96	1670	0	7	1376	0	0	44	0	0	85	0
Enter Blocked Intersection	No	No	No	No	No	No	No	No	No	No	No	No
Lane Alignment	Left	Left	Right	Left	Left	Right	Left	Left	Right	Left	Left	Right
Median Width(ft)	12			12			0				0	
Link Offset(ft)	0			0			0				0	
Crosswalk Width(ft)	16			16			16				16	
Two way Left Turn Lane												
Headway Factor	1.00	1.00	1.00	1.00	1.00	1.00	1.00	1.00	1.00	1.00	1.00	1.00
Turning Speed (mph)	15		9	15		9	15		9	15		9
Number of Detectors	1	1		1	1		1	1		1	1	
Detector Template												
Leading Detector (ft)	50	50		50	50		50	50		50	50	
Trailing Detector (ft)	0	0		0	0		0	0		0	0	
Detector 1 Position(ft)	0	0		0	0		0	0		0	0	
Detector 1 Size(ft)	50	50		50	50		50	50		50	50	
Detector 1 Type	Cl+Ex	Cl+Ex		Cl+Ex	Cl+Ex		Cl+Ex	Cl+Ex		Cl+Ex	Cl+Ex	
Detector 1 Channel												
Detector 1 Extend (s)	0.0	0.0		0.0	0.0		0.0	0.0		0.0	0.0	
Detector 1 Queue (s)	0.0	0.0		0.0	0.0		0.0	0.0		0.0	0.0	
Detector 1 Delay (s)	0.0	0.0		0.0	0.0		0.0	0.0		0.0	0.0	
Turn Type	Perm	NA		Perm	NA		Perm	NA		Perm	NA	
Protected Phases		6			2			4			4	
Permitted Phases	6			2			4			4		
Detector Phase	6	6		2	2		4	4		4	4	
Switch Phase												
Minimum Initial (s)	12.0	12.0		12.0	12.0		6.0	6.0		6.0	6.0	
Minimum Split (s)	17.0	17.0		17.0	17.0		23.5	23.5		23.5	23.5	
Total Split (s)	110.0	110.0		110.0	110.0		50.0	50.0		50.0	50.0	

Pepper Square TIA  
Lanes, Volumes, Timings

Phase 1, P, & N - 2033 Background + Site - PM  
1335: Meadow Creek & Belt Line



Lane Group	EBL	EBT	EBR	WBL	WBT	WBR	NBL	NBT	NBR	SBL	SBT	SBR
Total Split (%)	68.8%	68.8%		68.8%	68.8%		31.3%	31.3%		31.3%	31.3%	
Maximum Green (s)	105.0	105.0		105.0	105.0		44.5	44.5		44.5	44.5	
Yellow Time (s)	4.0	4.0		4.0	4.0		3.7	3.7		3.7	3.7	
All-Red Time (s)	1.0	1.0		1.0	1.0		1.8	1.8		1.8	1.8	
Lost Time Adjust (s)	-1.0	-1.0		-1.0	-1.0			-1.5			-1.5	
Total Lost Time (s)	4.0	4.0		4.0	4.0			4.0			4.0	
Lead/Lag												
Lead-Lag Optimize?												
Vehicle Extension (s)	2.0	2.0		2.0	2.0		1.8	1.8		1.8	1.8	
Recall Mode	Min	Min		C-Max	C-Max		None	None		None	None	
Walk Time (s)	4.0	4.0		4.0	4.0		4.0	4.0		4.0	4.0	
Flash Dont Walk (s)	8.0	8.0		8.0	8.0		14.0	14.0		14.0	14.0	
Pedestrian Calls (#/hr)	0	0		0	0		0	0		0	0	
Act Effect Green (s)	142.3	142.3		142.3	142.3			9.7			9.7	
Actuated g/C Ratio	0.89	0.89		0.89	0.89			0.06			0.06	
v/c Ratio	0.32	0.37		0.03	0.30			0.66			0.54	
Control Delay	3.4	0.8		0.1	0.2			98.7			35.7	
Queue Delay	0.0	0.0		0.0	0.0			0.0			0.0	
Total Delay	3.4	0.8		0.1	0.2			98.7			35.7	
LOS	A	A		A	A			F			D	
Approach Delay		0.9			0.2			98.7			35.7	
Approach LOS		A			A			F			D	
Queue Length 50th (ft)	2	14		0	5			34			19	
Queue Length 95th (ft)	5	21		m0	m6			80			77	
Internal Link Dist (ft)		1593			2324			312			343	
Turn Bay Length (ft)	150			150								
Base Capacity (vph)	299	4505		215	4513			277			495	
Starvation Cap Reductn	0	0		0	0			0			0	
Spillback Cap Reductn	0	0		0	0			0			0	
Storage Cap Reductn	0	0		0	0			0			0	
Reduced v/c Ratio	0.32	0.37		0.03	0.30			0.16			0.17	

Intersection Summary

Area Type: Other  
 Cycle Length: 160  
 Actuated Cycle Length: 160  
 Offset: 73 (46%), Referenced to phase 2:WBTL, Start of Yellow  
 Natural Cycle: 60  
 Control Type: Actuated-Coordinated  
 Maximum v/c Ratio: 0.66  
 Intersection Signal Delay: 2.8  
 Intersection LOS: A  
 Intersection Capacity Utilization 56.1%  
 ICU Level of Service B  
 Analysis Period (min) 15  
 m Volume for 95th percentile queue is metered by upstream signal.

Splits and Phases: 1335: Meadow Creek & Belt Line



Pepper Square TIA  
Lanes, Volumes, Timings

Phase 1, P, & N - 2033 Background + Site - PM  
1365: Preston & Arapahoe

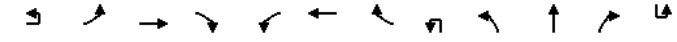

Lane Group	EBU	EBL	EBT	EBR	WBL	WBT	WBR	NBU	NBL	NBT	NBR	SBU
Lane Configurations		↑↑	↑↑↑		↑↑	↑↑↑			↑↑	↑↑↑		
Traffic Volume (vph)	1	287	997	242	209	635	155	3	230	1892	235	5
Future Volume (vph)	1	287	997	242	209	635	155	3	230	1892	235	5
Ideal Flow (vphpl)	1900	1900	1900	1900	1900	1900	1900	1900	1900	1900	1900	1900
Storage Length (ft)		150		0	150		0		300		0	
Storage Lanes		2		0	2		0		2		0	
Taper Length (ft)		25			25				25			
Lane Util. Factor	0.91	0.97	0.91	0.91	0.97	0.91	0.91	0.91	0.97	0.91	0.91	0.91
Frt			0.971			0.971					0.983	
Fit Protected		0.950			0.950				0.950			
Satd. Flow (prot)	0	3433	4938	0	3433	4938	0	0	3433	4999	0	0
Fit Permitted		0.950			0.950				0.950			
Satd. Flow (perm)	0	3433	4938	0	3433	4938	0	0	3433	4999	0	0
Right Turn on Red			Yes			Yes				Yes		
Satd. Flow (RTOR)			37			33				18		
Link Speed (mph)		42			42				42			
Link Distance (ft)		1672			1942				3054			
Travel Time (s)		27.1			31.5				49.6			
Peak Hour Factor	0.93	0.93	0.93	0.93	0.93	0.93	0.93	0.93	0.93	0.93	0.93	0.93
Adj. Flow (vph)	1	309	1072	260	225	683	167	3	247	2034	253	5
Shared Lane Traffic (%)												
Lane Group Flow (vph)	0	310	1332	0	225	850	0	0	250	2287	0	0
Enter Blocked Intersection	No	No	No	No	No	No	No	No	No	No	No	No
Lane Alignment	R NA	Left	Right	Left	Left	Right	R NA	Left	Left	Right	R NA	
Median Width(ft)		24			24				24			
Link Offset(ft)		0			0				0			
Crosswalk Width(ft)		16			16				16			
Two way Left Turn Lane												
Headway Factor	1.00	1.00	1.00	1.00	1.00	1.00	1.00	1.00	1.00	1.00	1.00	1.00
Turning Speed (mph)	9	15		9	15		9	15		9	15	9
Number of Detectors	1	1	1		1	1		1	1	1		1
Detector Template												
Leading Detector (ft)	50	50	50		50	50		50	50	50		50
Trailing Detector (ft)	0	0	0		0	0		0	0	0		0
Detector 1 Position(ft)	0	0	0		0	0		0	0	0		0
Detector 1 Size(ft)	50	50	50		50	50		50	50	50		50
Detector 1 Type	Cl+Ex	Cl+Ex	Cl+Ex		Cl+Ex	Cl+Ex		Cl+Ex	Cl+Ex	Cl+Ex		Cl+Ex
Detector 1 Channel												
Detector 1 Extend (s)	0.0	0.0	0.0		0.0	0.0		0.0	0.0	0.0		0.0
Detector 1 Queue (s)	0.0	0.0	0.0		0.0	0.0		0.0	0.0	0.0		0.0
Detector 1 Delay (s)	0.0	0.0	0.0		0.0	0.0		0.0	0.0	0.0		0.0
Turn Type	Prot	Prot	NA		Prot	NA		Prot	Prot	NA		Prot
Protected Phases	3	3	8		7	4		1	1	6		5
Permitted Phases												
Detector Phase	3	3	8		7	4		1	1	6		5
Switch Phase												
Minimum Initial (s)	3.0	3.0	18.0		3.0	18.0		3.0	3.0	18.0		3.0
Minimum Split (s)	10.0	10.0	36.7		21.0	36.3		10.0	10.0	35.7		10.0
Total Split (s)	30.0	30.0	53.0		13.0	36.0		24.0	24.0	76.0		18.0

Pepper Square TIA  
Lanes, Volumes, Timings

Phase 1, P, & N - 2033 Background + Site - PM  
1365: Preston & Arapho

Lane Group	SBL	SBT	SBR
Lane Configurations	↑↑	↑↑↑	
Traffic Volume (vph)	221	1516	199
Future Volume (vph)	221	1516	199
Ideal Flow (vphpl)	1900	1900	1900
Storage Length (ft)	250		0
Storage Lanes	2		0
Taper Length (ft)	25		
Lane Util. Factor	0.97	0.91	0.91
Frt		0.983	
Fit Protected	0.950		
Satd. Flow (prot)	3433	4999	0
Fit Permitted	0.950		
Satd. Flow (perm)	3433	4999	0
Right Turn on Red			Yes
Satd. Flow (RTOR)		18	
Link Speed (mph)		48	
Link Distance (ft)		5087	
Travel Time (s)		72.3	
Peak Hour Factor	0.93	0.93	0.93
Adj. Flow (vph)	238	1630	214
Shared Lane Traffic (%)			
Lane Group Flow (vph)	243	1844	0
Enter Blocked Intersection	No	No	No
Lane Alignment	Left	Left	Right
Median Width(ft)		24	
Link Offset(ft)		0	
Crosswalk Width(ft)		16	
Two way Left Turn Lane			
Headway Factor	1.00	1.00	1.00
Turning Speed (mph)	15		9
Number of Detectors	1	1	
Detector Template			
Leading Detector (ft)	50	50	
Trailing Detector (ft)	0	0	
Detector 1 Position(ft)	0	0	
Detector 1 Size(ft)	50	50	
Detector 1 Type	CI+Ex	CI+Ex	
Detector 1 Channel			
Detector 1 Extend (s)	0.0	0.0	
Detector 1 Queue (s)	0.0	0.0	
Detector 1 Delay (s)	0.0	0.0	
Turn Type	Prot	NA	
Protected Phases	5	2	
Permitted Phases			
Detector Phase	5	2	
Switch Phase			
Minimum Initial (s)	3.0	18.0	
Minimum Split (s)	10.0	37.7	
Total Split (s)	18.0	70.0	

Pepper Square TIA  
Lanes, Volumes, Timings

Phase 1, P, & N - 2033 Background + Site - PM  
1365: Preston & Arapho

Lane Group	EBU	EBL	EBT	EBR	WBL	WBT	WBR	NBU	NBL	NBT	NBR	SBU
Total Split (%)	18.8%	18.8%	33.1%		8.1%	22.5%		15.0%	15.0%	47.5%		11.3%
Maximum Green (s)	24.5	24.5	47.7		7.5	30.7		18.5	18.5	70.3		12.5
Yellow Time (s)	3.0	3.0	4.3		3.0	4.3		3.0	3.0	4.7		3.0
All-Red Time (s)	2.5	2.5	1.0		2.5	1.0		2.5	2.5	1.0		2.5
Lost Time Adjust (s)		-1.0	-1.4		-1.0	-1.0			-1.0	-1.7		
Total Lost Time (s)		4.5	3.9		4.5	4.3			4.5	4.0		
Lead/Lag	Lead	Lead	Lead		Lag	Lag		Lead	Lead	Lead		Lag
Lead-Lag Optimize?	Yes	Yes	Yes		Yes	Yes		Yes	Yes	Yes		Yes
Vehicle Extension (s)	0.8	0.8	2.5		0.8	1.8		1.5	1.5	1.7		1.5
Recall Mode	None	None	Max		None	None		None	None	Max		None
Walk Time (s)			4.0			4.0				4.0		
Flash Dont Walk (s)			27.0			27.0				26.0		
Pedestrian Calls (#/hr)			0			0				0		
Act Effect Green (s)		18.7	49.1		8.5	38.5			16.2	72.0		
Actuated g/C Ratio		0.12	0.31		0.05	0.24			0.10	0.45		
v/c Ratio		0.78	0.86		1.24	0.70			0.72	1.01		
Control Delay		81.1	57.1		196.1	52.2			93.6	37.4		
Queue Delay		0.0	0.0		0.0	0.0			0.0	0.0		
Total Delay		81.1	57.1		196.1	52.2			93.6	37.4		
LOS		F	E		F	D			F	D		
Approach Delay			61.7			82.3				42.9		
Approach LOS			E			F				D		
Queue Length 50th (ft)		165	472		-150	259			123	-219		
Queue Length 95th (ft)		212	535		#243	235			m128	m#283		
Internal Link Dist (ft)			1592			1862				2974		
Turn Bay Length (ft)		150			150				300			
Base Capacity (vph)		547	1540		182	1213			418	2259		
Starvation Cap Reductn		0	0		0	0			0	0		
Spillback Cap Reductn		0	0		0	0			0	0		
Storage Cap Reductn		0	0		0	0			0	0		
Reduced v/c Ratio		0.57	0.86		1.24	0.70			0.60	1.01		
<b>Intersection Summary</b>												
Area Type:	Other											
Cycle Length:	160											
Actuated Cycle Length:	160											
Offset:	120 (75%), Referenced to phase 2:SBT, Start of Yellow											
Natural Cycle:	150											
Control Type:	Actuated-Coordinated											
Maximum v/c Ratio:	1.24											
Intersection Signal Delay:	53.1						Intersection LOS: D					
Intersection Capacity Utilization:	93.0%						ICU Level of Service F					
Analysis Period (min)	15											
~	Volume exceeds capacity, queue is theoretically infinite. Queue shown is maximum after two cycles.											
#	95th percentile volume exceeds capacity, queue may be longer. Queue shown is maximum after two cycles.											
m	Volume for 95th percentile queue is metered by upstream signal.											



Pepper Square TIA  
Lanes, Volumes, Timings

Phase 1, P, & N - 2033 Background + Site - PM  
1365: Preston & Arapaho

Splits and Phases: 1365: Preston & Arapaho



Pepper Square TIA  
Lanes, Volumes, Timings

Phase 1, P, & N - 2033 Background + Site - PM  
1365: Preston & Arapaho

Lane Group	SBL	SBT	SBR
Total Split (%)	11.3%	43.8%	
Maximum Green (s)	12.5	64.3	
Yellow Time (s)	3.0	4.7	
All-Red Time (s)	2.5	1.0	
Lost Time Adjust (s)	-1.0	-1.7	
Total Lost Time (s)	4.5	4.0	
Lead/Lag	Lag	Lag	
Lead-Lag Optimize?	Yes	Yes	
Vehicle Extension (s)	1.5	1.5	
Recall Mode	None	C-Max	
Walk Time (s)		4.0	
Flash Dont Walk (s)		28.0	
Pedestrian Calls (#/hr)		0	
Act Effect Green (s)	13.5	69.3	
Actuated g/C Ratio	0.08	0.43	
v/c Ratio	0.84	0.85	
Control Delay	81.8	38.9	
Queue Delay	0.0	0.0	
Total Delay	81.8	38.9	
LOS	F	D	
Approach Delay		43.8	
Approach LOS		D	
Queue Length 50th (ft)	131	633	
Queue Length 95th (ft)	m158	706	
Internal Link Dist (ft)		5007	
Turn Bay Length (ft)	250		
Base Capacity (vph)	289	2175	
Starvation Cap Reductn	0	0	
Spillback Cap Reductn	0	0	
Storage Cap Reductn	0	0	
Reduced v/c Ratio	0.84	0.85	
<b>Intersection Summary</b>			

Pepper Square TIA  
Lanes, Volumes, Timings

Phase 1, P, & N - 2033 Background + Site - PM  
1367: Preston & Belt Line

Lane Group	EBU	EBL	EBT	EBR	WBU	WBL	WBT	WBR	NBL	NBT	NBR	SBU
Lane Configurations		↔↔	↕↕↕	↔		↔↔	↕↕↕		↔↔	↕↕↕		
Traffic Volume (vph)	47	405	1105	470	1	108	736	161	552	2041	64	2
Future Volume (vph)	47	405	1105	470	1	108	736	161	552	2041	64	2
Ideal Flow (vphpl)	1900	1900	1900	1900	1900	1900	1900	1900	1900	1900	1900	1900
Storage Length (ft)		150		150		200		0	250		0	
Storage Lanes		2		1		1		0	2		0	
Taper Length (ft)		25				25			25			
Lane Util. Factor	0.91	0.97	0.91	1.00	0.91	1.00	0.91	0.91	0.97	0.91	0.91	0.91
Fr			0.850				0.973			0.995		
Fit Protected		0.950				0.950			0.950			
Satd. Flow (prot)	0	3433	5085	1583	0	1770	4948	0	3433	5060	0	0
Fit Permitted		0.950				0.950			0.950			
Satd. Flow (perm)	0	3433	5085	1583	0	1770	4948	0	3433	5060	0	0
Right Turn on Red				Yes			Yes			Yes		
Satd. Flow (RTOR)				257			25			4		
Link Speed (mph)			42				42			42		
Link Distance (ft)			925				394			261		
Travel Time (s)			15.0				6.4			4.2		
Peak Hour Factor	0.96	0.96	0.96	0.96	0.96	0.96	0.96	0.96	0.96	0.96	0.96	0.96
Adj. Flow (vph)	49	422	1151	490	1	113	767	168	575	2126	67	2
Shared Lane Traffic (%)												
Lane Group Flow (vph)	0	471	1151	490	0	114	935	0	575	2193	0	0
Enter Blocked Intersection	No	No	No	No	No	No	No	No	No	No	No	No
Lane Alignment	R NA	Left	Left	Right	R NA	Left	Right	Left	Left	Right	R NA	
Median Width(ft)		24				24			24			
Link Offset(ft)		0				0			0			
Crosswalk Width(ft)			16			16			16			
Two way Left Turn Lane												
Headway Factor	1.00	1.00	1.00	1.00	1.00	1.00	1.00	1.00	1.00	1.00	1.00	1.00
Turning Speed (mph)	9	15		9	9	15		9	15		9	9
Number of Detectors	1	1	1	1	1	1	1	1	1	1	1	1
Detector Template												
Leading Detector (ft)	50	50	50	50	50	50	50	50	50	50	50	50
Trailing Detector (ft)	0	0	0	0	0	0	0	0	0	0	0	0
Detector 1 Position(ft)	0	0	0	0	0	0	0	0	0	0	0	0
Detector 1 Size(ft)	50	50	50	50	50	50	50	50	50	50	50	50
Detector 1 Type	Cl+Ex	Cl+Ex	Cl+Ex	Cl+Ex	Cl+Ex	Cl+Ex	Cl+Ex	Cl+Ex	Cl+Ex	Cl+Ex	Cl+Ex	Cl+Ex
Detector 1 Channel												
Detector 1 Extend (s)	0.0	0.0	0.0	0.0	0.0	0.0	0.0	0.0	0.0	0.0	0.0	0.0
Detector 1 Queue (s)	0.0	0.0	0.0	0.0	0.0	0.0	0.0	0.0	0.0	0.0	0.0	0.0
Detector 1 Delay (s)	0.0	0.0	0.0	0.0	0.0	0.0	0.0	0.0	0.0	0.0	0.0	0.0
Turn Type	Prot	Prot	NA	Perm	Prot	Prot	NA	Prot	NA	Prot	NA	Prot
Protected Phases	3 13	3 13	8		17	17	4		1 11	6		5
Permitted Phases				8								
Detector Phase	3 13	3 13	8	8	17	17	4		1 11	6		5
Switch Phase												
Minimum Initial (s)			18.0	18.0	3.0	3.0	18.0			18.0		3.0
Minimum Split (s)			32.5	32.5	8.0	8.0	32.5			33.0		11.0
Total Split (s)			50.0	50.0	14.0	14.0	27.0			77.0		19.0

Pepper Square TIA  
Lanes, Volumes, Timings

Phase 1, P, & N - 2033 Background + Site - PM  
1367: Preston & Belt Line

Lane Group	SBL	SBT	SBR	Ø1	Ø3	Ø11	Ø13
Lane Configurations	↔	↕↕↕	↔				
Traffic Volume (vph)	194	1570	295				
Future Volume (vph)	194	1570	295				
Ideal Flow (vphpl)	1900	1900	1900				
Storage Length (ft)	200		300				
Storage Lanes	1		1				
Taper Length (ft)	25						
Lane Util. Factor	1.00	0.91	1.00				
Fr			0.850				
Fit Protected	0.950						
Satd. Flow (prot)	1770	5085	1583				
Fit Permitted	0.950						
Satd. Flow (perm)	1770	5085	1583				
Right Turn on Red			Yes				
Satd. Flow (RTOR)			230				
Link Speed (mph)		40					
Link Distance (ft)		3054					
Travel Time (s)		52.1					
Peak Hour Factor	0.96	0.96	0.96				
Adj. Flow (vph)	202	1635	307				
Shared Lane Traffic (%)							
Lane Group Flow (vph)	204	1635	307				
Enter Blocked Intersection	No	No	No				
Lane Alignment	Left	Left	Right				
Median Width(ft)		24					
Link Offset(ft)		0					
Crosswalk Width(ft)			16				
Two way Left Turn Lane							
Headway Factor	1.00	1.00	1.00				
Turning Speed (mph)	15		9				
Number of Detectors	1	1	1				
Detector Template							
Leading Detector (ft)	50	50	50				
Trailing Detector (ft)	0	0	0				
Detector 1 Position(ft)	0	0	0				
Detector 1 Size(ft)	50	50	50				
Detector 1 Type	Cl+Ex	Cl+Ex	Cl+Ex				
Detector 1 Channel							
Detector 1 Extend (s)	0.0	0.0	0.0				
Detector 1 Queue (s)	0.0	0.0	0.0				
Detector 1 Delay (s)	0.0	0.0	0.0				
Turn Type	Prot	NA	Perm				
Protected Phases	5	2		1	3	11	13
Permitted Phases			2				
Detector Phase	5	2	2				
Switch Phase							
Minimum Initial (s)	3.0	18.0	18.0	3.0	3.0	3.0	3.0
Minimum Split (s)	11.0	33.0	33.0	8.0	11.0	8.0	11.0
Total Split (s)	19.0	60.0	60.0	16.0	20.0	20.0	17.0

Pepper Square TIA  
Lanes, Volumes, Timings

Phase 1, P, & N - 2033 Background + Site - PM  
1367: Preston & Belt Line

Lane Group	EBU	EBL	EBT	EBR	WBU	WBL	WBT	WBR	NBL	NBT	NBR	SBU
Total Split (%)			31.3%	31.3%	8.8%	8.8%	16.9%			48.1%		11.9%
Maximum Green (s)			44.5	44.5	9.0	9.0	21.5			71.0		14.0
Yellow Time (s)			4.0	4.0	3.0	3.0	4.0			4.4		3.0
All-Red Time (s)			1.5	1.5	2.0	2.0	1.5			1.6		2.0
Lost Time Adjust (s)			-1.5	-1.5		-1.0	-1.5			-1.7		
Total Lost Time (s)			4.0	4.0		4.0	4.0			4.3		
Lead/Lag							Lag			Lag		Lead
Lead-Lag Optimize?							Yes			Yes		Yes
Vehicle Extension (s)			1.3	1.3	3.0	3.0	1.3			2.0		1.5
Recall Mode			Max	Max	None	None	Max			C-Max		None
Walk Time (s)			7.0	7.0			7.0			7.0		
Flash Dont Walk (s)			20.0	20.0			20.0			20.0		
Pedestrian Calls (#/hr)			0	0			0			0		
Act Effect Green (s)			28.9	46.0	46.0		10.0	23.1		28.0		72.7
Actuated g/C Ratio			0.18	0.29	0.29		0.06	0.14		0.18		0.45
v/c Ratio			0.76	0.79	0.77		1.04	1.27		0.96		0.95
Control Delay			60.2	61.9	39.7		146.2	162.0		70.4		29.8
Queue Delay			0.0	0.0	0.0		0.0	0.0		0.0		14.0
Total Delay			60.2	61.9	39.7		146.2	162.0		70.4		43.8
LOS			E	E	D		F	F		E		D
Approach Delay			56.4				160.2					49.4
Approach LOS			E				F					D
Queue Length 50th (ft)			200	432	275		~130	~432		251		795
Queue Length 95th (ft)			274	488	449		#269	#528		#398		#725
Internal Link Dist (ft)			845				314					181
Turn Bay Length (ft)			150	150			200			250		
Base Capacity (vph)			622	1461	638		110	734		600		2301
Starvation Cap Reductn			0	0	0		0	0		0		163
Spillback Cap Reductn			0	0	1		0	0		0		0
Storage Cap Reductn			0	0	0		0	0		0		0
Reduced v/c Ratio			0.76	0.79	0.77		1.04	1.27		0.96		1.03

Intersection Summary

Area Type:	Other
Cycle Length:	160
Actuated Cycle Length:	160
Offset:	56 (35%), Referenced to phase 6:NBT, Start of Yellow
Natural Cycle:	145
Control Type:	Actuated-Coordinated
Maximum v/c Ratio:	1.27
Intersection Signal Delay:	67.0
Intersection LOS:	E
Intersection Capacity Utilization:	96.0%
ICU Level of Service:	F
Analysis Period (min):	15
~	Volume exceeds capacity, queue is theoretically infinite. Queue shown is maximum after two cycles.
#	95th percentile volume exceeds capacity, queue may be longer. Queue shown is maximum after two cycles.
m	Volume for 95th percentile queue is metered by upstream signal.

Pepper Square TIA  
Lanes, Volumes, Timings

Phase 1, P, & N - 2033 Background + Site - PM  
1367: Preston & Belt Line

Splits and Phases: 1367: Preston & Belt Line

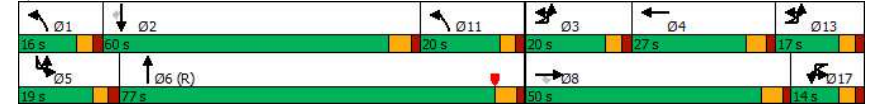

Pepper Square TIA  
Lanes, Volumes, Timings

Phase 1, P, & N - 2033 Background + Site - PM  
1367: Preston & Belt Line

Lane Group	SBL	SBT	SBR	Ø1	Ø3	Ø11	Ø13
Total Split (%)	11.9%	37.5%	37.5%	10%	13%	13%	11%
Maximum Green (s)	14.0	54.0	54.0	11.0	15.0	15.0	12.0
Yellow Time (s)	3.0	4.4	4.4	3.0	3.0	3.0	3.0
All-Red Time (s)	2.0	1.6	1.6	2.0	2.0	2.0	2.0
Lost Time Adjust (s)	-1.0	-1.7	-1.7				
Total Lost Time (s)	4.0	4.3	4.3				
Lead/Lag	Lead	Lag	Lag	Lead	Lead		
Lead-Lag Optimize?	Yes	Yes	Yes	Yes	Yes		
Vehicle Extension (s)	1.5	2.5	2.5	1.6	1.3	3.0	3.0
Recall Mode	None	Max	Max	None	None	None	None
Walk Time (s)		7.0	7.0				
Flash Dont Walk (s)		20.0	20.0				
Pedestrian Calls (#/hr)		0	0				
Act Effect Green (s)	15.0	55.7	55.7				
Actuated g/C Ratio	0.09	0.35	0.35				
v/c Ratio	1.24	0.92	0.44				
Control Delay	178.3	47.0	9.8				
Queue Delay	0.0	0.8	0.0				
Total Delay	178.3	47.7	9.8				
LOS	F	D	A				
Approach Delay		54.7					
Approach LOS		D					
Queue Length 50th (ft)	~259	642	132				
Queue Length 95th (ft)	m#322	m680	m122				
Internal Link Dist (ft)		2974					
Turn Bay Length (ft)	200		300				
Base Capacity (vph)	165	1770	701				
Starvation Cap Reductn	0	0	0				
Spillback Cap Reductn	0	29	0				
Storage Cap Reductn	0	0	0				
Reduced v/c Ratio	1.24	0.94	0.44				

Intersection Summary

Pepper Square TIA  
Lanes, Volumes, Timings

Phase 1, P, & N - 2033 Background + Site - PM  
1368: Preston & Alexis

Lane Group	EBL	EBT	EBR	WBL	WBT	WBR	NBU	NBL	NBT	NBR	SBL	SBT
Lane Configurations												
Traffic Volume (vph)	68	24	66	288	24	109	7	45	2534	275	263	1794
Future Volume (vph)	68	24	66	288	24	109	7	45	2534	275	263	1794
Ideal Flow (vphpl)	1900	1900	1900	1900	1900	1900	1900	1900	1900	1900	1900	1900
Storage Length (ft)	0		0	175		0		150		150	150	
Storage Lanes	1		1	2		1		1		1	1	
Taper Length (ft)	25			25				25			25	
Lane Util. Factor	0.91	0.91	1.00	0.97	1.00	1.00	0.91	1.00	0.91	1.00	1.00	0.91
Frt			0.850			0.850				0.850		
Fit Protected	0.950	0.971		0.950				0.950			0.950	
Satd. Flow (prot)	1610	3292	1583	3433	1863	1583	0	1770	5085	1583	1770	5085
Fit Permitted	0.950	0.971		0.950				0.083			0.040	
Satd. Flow (perm)	1610	3292	1583	3433	1863	1583	0	155	5085	1583	75	5085
Right Turn on Red			Yes			Yes				Yes		
Satd. Flow (RTOR)			125			89				105		
Link Speed (mph)		30			30			43				42
Link Distance (ft)		660			627			2867				173
Travel Time (s)		15.0			14.3			45.5				2.8
Peak Hour Factor	0.95	0.95	0.95	0.95	0.95	0.95	0.95	0.95	0.95	0.95	0.95	0.95
Adj. Flow (vph)	72	25	69	303	25	115	7	47	2667	289	277	1888
Shared Lane Traffic (%)	50%											
Lane Group Flow (vph)	36	61	69	303	25	115	0	54	2667	289	277	1888
Enter Blocked Intersection	No	No	No	No	No	No	No	No	No	No	No	No
Lane Alignment	Left	Left	Right	Left	Left	Right	R NA	Left	Left	Right	Left	Left
Median Width(ft)	24			24				12				12
Link Offset(ft)	0			0				0				0
Crosswalk Width(ft)	16			16				16				16
Two way Left Turn Lane												
Headway Factor	1.00	1.00	1.00	1.00	1.00	1.00	1.00	1.00	1.00	1.00	1.00	1.00
Turning Speed (mph)	15		9	15		9	9	15		9	15	
Number of Detectors	1	1	1	1	1	1	1	1	1	1	1	1
Detector Template												
Leading Detector (ft)	50	50	50	50	50	50	50	50	50	50	50	50
Trailing Detector (ft)	0	0	0	0	0	0	0	0	0	0	0	0
Detector 1 Position(ft)	0	0	0	0	0	0	0	0	0	0	0	0
Detector 1 Size(ft)	50	50	50	50	50	50	50	50	50	50	50	50
Detector 1 Type	Cl+Ex	Cl+Ex	Cl+Ex	Cl+Ex	Cl+Ex	Cl+Ex	Cl+Ex	Cl+Ex	Cl+Ex	Cl+Ex	Cl+Ex	Cl+Ex
Detector 1 Channel												
Detector 1 Extend (s)	0.0	0.0	0.0	0.0	0.0	0.0	0.0	0.0	0.0	0.0	0.0	0.0
Detector 1 Queue (s)	0.0	0.0	0.0	0.0	0.0	0.0	0.0	0.0	0.0	0.0	0.0	0.0
Detector 1 Delay (s)	0.0	0.0	0.0	0.0	0.0	0.0	0.0	0.0	0.0	0.0	0.0	0.0
Turn Type	Split	NA	Perm	Split	NA	pm+ov	D,P+P	D,P+P	NA	Perm	D,P+P	NA
Permitted Phases	3	3		4	4	5	1	1	6		5	2
Permitted Phases			3			4	2	2		6		6
Detector Phase	3	3	3	4	4	5	1	1	6	6	5	2
Switch Phase												
Minimum Initial (s)	6.0	6.0	6.0	8.0	8.0	3.0	3.0	3.0	14.0	14.0	3.0	14.0
Minimum Split (s)	27.0	27.0	27.0	27.0	27.0	8.4	8.4	8.4	24.0	24.0	8.4	24.0
Total Split (s)	23.0	23.0	23.0	22.0	22.0	20.0	15.0	15.0	95.0	95.0	20.0	100.0

Pepper Square TIA  
Lanes, Volumes, Timings

Phase 1, P, & N - 2033 Background + Site - PM  
1368: Preston & Alexis

Lane Group	SBR
Left Configurations	↑
Traffic Volume (vph)	23
Future Volume (vph)	23
Ideal Flow (vphpl)	1900
Storage Length (ft)	150
Storage Lanes	1
Taper Length (ft)	
Lane Util. Factor	1.00
Frt	0.850
Fit Protected	
Satd. Flow (prot)	1583
Fit Permitted	
Satd. Flow (perm)	1583
Right Turn on Red	Yes
Satd. Flow (RTOR)	78
Link Speed (mph)	
Link Distance (ft)	
Travel Time (s)	
Peak Hour Factor	0.95
Adj. Flow (vph)	24
Shared Lane Traffic (%)	
Lane Group Flow (vph)	24
Enter Blocked Intersection	No
Lane Alignment	Right
Median Width(ft)	
Link Offset(ft)	
Crosswalk Width(ft)	
Two way Left Turn Lane	
Headway Factor	1.00
Turning Speed (mph)	9
Number of Detectors	1
Detector Template	
Leading Detector (ft)	50
Trailing Detector (ft)	0
Detector 1 Position(ft)	0
Detector 1 Size(ft)	50
Detector 1 Type	CI+Ex
Detector 1 Channel	
Detector 1 Extend (s)	0.0
Detector 1 Queue (s)	0.0
Detector 1 Delay (s)	0.0
Turn Type	Perm
Protected Phases	
Permitted Phases	2
Detector Phase	2
Switch Phase	
Minimum Initial (s)	14.0
Minimum Split (s)	24.0
Total Split (s)	100.0

Pepper Square TIA  
Lanes, Volumes, Timings

Phase 1, P, & N - 2033 Background + Site - PM  
1368: Preston & Alexis

Lane Group	EBL	EBT	EBR	WBL	WBT	WBR	NBU	NBL	NBT	NBR	SBL	SBT
Total Split (%)	14.4%	14.4%	14.4%	13.8%	13.8%	12.5%	9.4%	9.4%	59.4%	59.4%	12.5%	62.5%
Maximum Green (s)	18.0	18.0	18.0	17.0	17.0	15.6	10.6	10.6	89.0	89.0	15.6	94.0
Yellow Time (s)	4.0	4.0	4.0	4.0	4.0	3.4	3.4	3.4	4.5	4.5	3.4	4.5
All-Red Time (s)	1.0	1.0	1.0	1.0	1.0	1.0	1.0	1.0	1.5	1.5	1.0	1.5
Lost Time Adjust (s)	-1.0	-1.0	0.0	-1.0	-1.0	0.0			-1.0	-2.0	0.0	-1.0
Total Lost Time (s)	4.0	4.0	5.0	4.0	4.0	4.4			3.4	4.0	6.0	3.4
Lead/Lag	Lag	Lag	Lag	Lead	Lead	Lag	Lead	Lead	Lead	Lead	Lag	Lag
Lead-Lag Optimize?	Yes	Yes	Yes	Yes	Yes	Yes	Yes	Yes	Yes	Yes	Yes	Yes
Vehicle Extension (s)	2.0	2.0	2.0	2.0	2.0	1.2	1.2	1.2	2.5	2.5	1.2	2.5
Recall Mode	None	None	None	None	None	None	None	None	Max	Max	None	C-Max
Walk Time (s)	4.0	4.0	4.0	4.0	4.0				4.0	4.0		4.0
Flash Dont Walk (s)	18.0	18.0	18.0	18.0	18.0				14.0	14.0		14.0
Pedestrian Calls (#/hr)	0	0	0	0	0				0	0		0
Act Effect Green (s)	9.3	9.3	8.3	17.3	17.3	36.9			119.3	101.4	99.4	118.6
Actuated g/C Ratio	0.06	0.06	0.05	0.11	0.11	0.23			0.75	0.63	0.62	0.74
v/c Ratio	0.39	0.32	0.34	0.82	0.12	0.27			0.31	0.83	0.28	1.20
Control Delay	83.8	76.0	4.7	87.5	65.7	16.0			9.4	22.7	7.4	151.5
Queue Delay	0.0	0.0	0.0	0.0	0.0	0.0			0.0	0.1	0.0	0.0
Total Delay	83.8	76.0	4.7	87.5	65.7	16.0			9.4	22.8	7.4	151.5
LOS	F	E	A	F	E	B			A	C	A	F
Approach Delay		48.0			67.7				21.1			22.4
Approach LOS		D			E				C			C
Queue Length 50th (ft)	40	34	0	161	24	21			11	741	55	-305
Queue Length 95th (ft)	84	61	0	#225	57	78			22	934	92	#490
Internal Link Dist (ft)		580			547				2787			93
Turn Bay Length (ft)				175					150		150	
Base Capacity (vph)	191	390	289	386	209	433			235	3222	1023	231
Starvation Cap Reductn	0	0	0	0	0	0			0	0	0	0
Spillback Cap Reductn	0	0	0	0	0	0			0	31	0	0
Storage Cap Reductn	0	0	0	0	0	0			0	0	0	0
Reduced v/c Ratio	0.19	0.16	0.24	0.78	0.12	0.27			0.23	0.84	0.28	1.20

Intersection Summary

Area Type:	Other
Cycle Length:	160
Actuated Cycle Length:	160
Offset:	63 (39%), Referenced to phase 2:NBSB, Start of Yellow
Natural Cycle:	150
Control Type:	Actuated-Coordinated
Maximum v/c Ratio:	1.20
Intersection Signal Delay:	25.9
Intersection LOS:	C
Intersection Capacity Utilization:	88.4%
ICU Level of Service:	E
Analysis Period (min):	15
~	Volume exceeds capacity, queue is theoretically infinite. Queue shown is maximum after two cycles.
#	95th percentile volume exceeds capacity, queue may be longer. Queue shown is maximum after two cycles.
m	Volume for 95th percentile queue is metered by upstream signal.

Pepper Square TIA  
Lanes, Volumes, Timings

Phase 1, P, & N - 2033 Background + Site - PM  
1368: Preston & Alexis

Splits and Phases: 1368: Preston & Alexis



Pepper Square TIA  
Lanes, Volumes, Timings

Phase 1, P, & N - 2033 Background + Site - PM  
1368: Preston & Alexis

Lane Group	SBR
Total Split (%)	62.5%
Maximum Green (s)	94.0
Yellow Time (s)	4.5
All-Red Time (s)	1.5
Lost Time Adjust (s)	0.0
Total Lost Time (s)	6.0
Lead/Lag	Lag
Lead-Lag Optimize?	Yes
Vehicle Extension (s)	2.5
Recall Mode	C-Max
Walk Time (s)	4.0
Flash Dont Walk (s)	14.0
Pedestrian Calls (#/hr)	0
Act Effect Green (s)	111.7
Actuated g/C Ratio	0.70
v/c Ratio	0.02
Control Delay	0.0
Queue Delay	0.0
Total Delay	0.0
LOS	A
Approach Delay	
Approach LOS	
Queue Length 50th (ft)	0
Queue Length 95th (ft)	m0
Internal Link Dist (ft)	
Turn Bay Length (ft)	150
Base Capacity (vph)	1128
Starvation Cap Reductn	0
Spillback Cap Reductn	0
Storage Cap Reductn	0
Reduced v/c Ratio	0.02
Intersection Summary	

Pepper Square TIA  
Lanes, Volumes, Timings

Phase 1, P, & N - 2033 Background + Site - PM  
1369: Preston & Belt Line Village Driveway

Lane Group	EBL	EBT	EBR	WBL	WBT	WBR	NBU	NBL	NBT	NBR	SBU	SBL
Lane Configurations		↑↑		↓	↓			↓	↑↑↑			↓
Traffic Volume (vph)	82	5	55	123	6	61	1	69	2450	59	8	167
Future Volume (vph)	82	5	55	123	6	61	1	69	2450	59	8	167
Ideal Flow (vphpl)	1900	1900	1900	1900	1900	1900	1900	1900	1900	1900	1900	1900
Storage Length (ft)	0	0	0	0	0	0	0	100	0	0	0	100
Storage Lanes	0	0	0	1	0	0	0	1	0	0	0	1
Taper Length (ft)	25			25				25				25
Lane Util. Factor	0.95	0.95	0.95	1.00	1.00	1.00	0.91	1.00	0.91	0.91	0.91	1.00
Frt		0.942				0.863			0.996			
Fit Protected		0.972		0.950				0.950				0.950
Satd. Flow (prot)	0	3241	0	1770	1608	0	0	1770	5065	0	0	1770
Fit Permitted		0.742		0.595				0.060				0.035
Satd. Flow (perm)	0	2474	0	1108	1608	0	0	112	5065	0	0	65
Right Turn on Red			Yes			Yes				Yes		
Satd. Flow (RTOR)		57			63				4			
Link Speed (mph)		30			30				42			
Link Distance (ft)		303			249				252			
Travel Time (s)		6.9			5.7				4.1			
Peak Hour Factor	0.97	0.97	0.97	0.97	0.97	0.97	0.97	0.97	0.97	0.97	0.97	0.97
Adj. Flow (vph)	85	5	57	127	6	63	1	71	2526	61	8	172
Shared Lane Traffic (%)												
Lane Group Flow (vph)	0	147	0	127	69	0	0	72	2587	0	0	180
Enter Blocked Intersection	No	No	No	No	No	No	No	No	No	No	No	No
Lane Alignment	Left	Left	Right	Left	Left	Right	R NA	Left	Left	Right	R NA	Left
Median Width(ft)		12			12				12			
Link Offset(ft)		0			0				0			
Crosswalk Width(ft)		16			16				16			
Two way Left Turn Lane												
Headway Factor	1.00	1.00	1.00	1.00	1.00	1.00	1.00	1.00	1.00	1.00	1.00	1.00
Turning Speed (mph)	15		9	15		9	9	15		9	9	15
Number of Detectors	1	1		1	1		1	1	1		1	1
Detector Template												
Leading Detector (ft)	50	50		50	50		50	50	50		50	50
Trailing Detector (ft)	0	0		0	0		0	0	0		0	0
Detector 1 Position(ft)	0	0		0	0		0	0	0		0	0
Detector 1 Size(ft)	50	50		50	50		50	50	50		50	50
Detector 1 Type	Cl+Ex	Cl+Ex		Cl+Ex	Cl+Ex		Cl+Ex	Cl+Ex	Cl+Ex		Cl+Ex	Cl+Ex
Detector 1 Channel												
Detector 1 Extend (s)	0.0	0.0		0.0	0.0		0.0	0.0	0.0		0.0	0.0
Detector 1 Queue (s)	0.0	0.0		0.0	0.0		0.0	0.0	0.0		0.0	0.0
Detector 1 Delay (s)	0.0	0.0		0.0	0.0		0.0	0.0	0.0		0.0	0.0
Turn Type	Perm	NA		Perm	NA		custom	D.P+P	NA		custom	D.P+P
Protected Phases		8			4			1	2			5
Permitted Phases	8			4			1	2			5	6
Detector Phase	8	8		4	4		1	1	6		5	5
Switch Phase												
Minimum Initial (s)	20.0	20.0		20.0	20.0		5.0	5.0	20.0		5.0	5.0
Minimum Split (s)	25.0	25.0		25.0	25.0		10.0	10.0	26.0		10.0	10.0
Total Split (s)	47.0	47.0		47.0	47.0		20.0	20.0	98.0		15.0	15.0

Pepper Square TIA  
Lanes, Volumes, Timings

Phase 1, P, & N - 2033 Background + Site - PM  
1369: Preston & Belt Line Village Driveway

Lane Group	SBT	SBR
Lane Configurations	↑↑↑	
Traffic Volume (vph)	2049	27
Future Volume (vph)	2049	27
Ideal Flow (vphpl)	1900	1900
Storage Length (ft)	0	0
Storage Lanes	0	0
Taper Length (ft)		
Lane Util. Factor	0.91	0.91
Frt	0.998	
Fit Protected		
Satd. Flow (prot)	5075	0
Fit Permitted		
Satd. Flow (perm)	5075	0
Right Turn on Red		Yes
Satd. Flow (RTOR)	2	
Link Speed (mph)	38	
Link Distance (ft)	191	
Travel Time (s)	3.4	
Peak Hour Factor	0.97	0.97
Adj. Flow (vph)	2112	28
Shared Lane Traffic (%)		
Lane Group Flow (vph)	2140	0
Enter Blocked Intersection	No	No
Lane Alignment	Left	Right
Median Width(ft)	12	
Link Offset(ft)	0	
Crosswalk Width(ft)	16	
Two way Left Turn Lane		
Headway Factor	1.00	1.00
Turning Speed (mph)		9
Number of Detectors	1	
Detector Template		
Leading Detector (ft)	50	
Trailing Detector (ft)	0	
Detector 1 Position(ft)	0	
Detector 1 Size(ft)	50	
Detector 1 Type	Cl+Ex	
Detector 1 Channel		
Detector 1 Extend (s)	0.0	
Detector 1 Queue (s)	0.0	
Detector 1 Delay (s)	0.0	
Turn Type	NA	
Protected Phases	2	
Permitted Phases		
Detector Phase	2	
Switch Phase		
Minimum Initial (s)	20.0	
Minimum Split (s)	26.0	
Total Split (s)	93.0	

Pepper Square TIA  
Lanes, Volumes, Timings

Phase 1, P, & N - 2033 Background + Site - PM  
1369: Preston & Belt Line Village Driveway

Lane Group	EBL	EBT	EBR	WBL	WBT	WBR	NBU	NBL	NBT	NBR	SBU	SBL
Total Split (%)	29.4%	29.4%		29.4%	29.4%		12.5%	12.5%	61.3%		9.4%	9.4%
Maximum Green (s)	42.3	42.3		42.3	42.3		15.0	15.0	93.7		10.0	10.0
Yellow Time (s)	3.0	3.0		3.0	3.0		3.0	3.0	3.0		3.0	3.0
All-Red Time (s)	1.7	1.7		1.7	1.7		2.0	2.0	1.3		2.0	2.0
Lost Time Adjust (s)		-1.0		-1.0	-1.0			-1.0	-2.0			-1.0
Total Lost Time (s)		3.7		3.7	3.7			4.0	2.3			4.0
Lead/Lag							Lead	Lead	Lead		Lag	Lag
Lead-Lag Optimize?							Yes	Yes	Yes		Yes	Yes
Vehicle Extension (s)	2.0	2.0		2.0	2.0		1.5	1.5	3.0		1.5	1.5
Recall Mode	None	None		None	None		None	None	Max		None	None
Walk Time (s)	5.0	5.0		5.0	5.0				7.0			
Flash Dont Walk (s)	15.0	15.0		15.0	15.0				8.0			
Pedestrian Calls (#/hr)	0	0		0	0				0			
Act Effect Green (s)		24.6		24.6	24.6		123.7	114.4				123.7
Actuated g/C Ratio		0.15		0.15	0.15		0.77	0.72				0.77
v/c Ratio		0.34		0.75	0.23		0.43	0.71				1.08
Control Delay		37.9		89.9	16.0		22.4	3.7				118.3
Queue Delay		0.0		0.0	0.0		0.0	0.5				0.0
Total Delay		37.9		89.9	16.0		22.4	4.2				118.3
LOS		D		F	B		C	A				F
Approach Delay		37.9			63.9			4.7				
Approach LOS		D			E			A				
Queue Length 50th (ft)		44		131	6		9	52				~158
Queue Length 95th (ft)		77		199	51		m19	270				m#223
Internal Link Dist (ft)		223			169			172				
Turn Bay Length (ft)							100					100
Base Capacity (vph)		711		299	481		254	3621				167
Starvation Cap Reductn		0		0	0		0	511				0
Spillback Cap Reductn		2		0	5		0	435				0
Storage Cap Reductn		0		0	0		0	0				0
Reduced v/c Ratio		0.21		0.42	0.14		0.28	0.83				1.08

Intersection Summary

Area Type:	Other
Cycle Length:	160
Actuated Cycle Length:	160
Offset:	86 (54%), Referenced to phase 2:NBSB, Start of Yellow
Natural Cycle:	80
Control Type:	Actuated-Coordinated
Maximum v/c Ratio:	1.08
Intersection Signal Delay:	11.8
Intersection LOS:	B
Intersection Capacity Utilization:	85.0%
ICU Level of Service:	E
Analysis Period (min):	15
~	Volume exceeds capacity, queue is theoretically infinite. Queue shown is maximum after two cycles.
#	95th percentile volume exceeds capacity, queue may be longer. Queue shown is maximum after two cycles.
m	Volume for 95th percentile queue is metered by upstream signal.

Pepper Square TIA  
Lanes, Volumes, Timings

Phase 1, P, & N - 2033 Background + Site - PM  
1369: Preston & Belt Line Village Driveway

Splits and Phases: 1369: Preston & Belt Line Village Driveway





Pepper Square TIA  
Lanes, Volumes, Timings

Phase 1, P, & N - 2033 Background + Site - PM  
1369: Preston & Belt Line Village Driveway

Lane Group	SBT	SBR
Total Split (%)	58.1%	
Maximum Green (s)	88.7	
Yellow Time (s)	3.0	
All-Red Time (s)	1.3	
Lost Time Adjust (s)	-2.0	
Total Lost Time (s)	2.3	
Lead/Lag	Lag	
Lead-Lag Optimize?	Yes	
Vehicle Extension (s)	3.3	
Recall Mode	C-Max	
Walk Time (s)	7.0	
Flash Dont Walk (s)	8.0	
Pedestrian Calls (#/hr)	0	
Act Effect Green (s)	117.3	
Actuated g/C Ratio	0.73	
v/c Ratio	0.58	
Control Delay	4.5	
Queue Delay	0.6	
Total Delay	5.1	
LOS	A	
Approach Delay	13.9	
Approach LOS	B	
Queue Length 50th (ft)	105	
Queue Length 95th (ft)	m169	
Internal Link Dist (ft)	111	
Turn Bay Length (ft)		
Base Capacity (vph)	3721	
Starvation Cap Reductn	1055	
Spillback Cap Reductn	0	
Storage Cap Reductn	0	
Reduced v/c Ratio	0.80	

Intersection Summary

Pepper Square TIA  
Lanes, Volumes, Timings

Phase 1, P, & N - 2033 Background + Site - PM  
1371: Preston & Spring Valley

Lane Group	EBL	EBT	EBR	WBL	WBT	WBR	NBU	NBL	NBT	NBR	SBU	SBL
Lane Configurations	↑↑	↑↑↑		↑↑	↑↑↑			↑↑	↑↑↑			↑↑
Traffic Volume (vph)	364	807	230	106	496	189	1	195	2444	203	6	176
Future Volume (vph)	364	807	230	106	496	189	1	195	2444	203	6	176
Ideal Flow (vphpl)	1900	1900	1900	1900	1900	1900	1900	1900	1900	1900	1900	1900
Storage Length (ft)	225		0	225		0		225		0		275
Storage Lanes	2		0	2		0		2		0		2
Taper Length (ft)	25			25				25				25
Lane Util. Factor	0.97	0.91	0.91	0.97	0.91	0.91	0.91	0.97	0.91	0.91	0.91	0.97
Fr		0.967			0.959				0.988			
Fit Protected	0.950			0.950				0.950				0.950
Satd. Flow (prot)	3433	4917	0	3433	4877	0	0	3433	5024	0	0	3433
Fit Permitted	0.950			0.950				0.950				0.950
Satd. Flow (perm)	3433	4917	0	3433	4877	0	0	3433	5024	0	0	3433
Right Turn on Red			Yes			Yes				Yes		
Satd. Flow (RTOR)		45			49				12			
Link Speed (mph)		38			42				41			
Link Distance (ft)		3259			5488				2139			
Travel Time (s)		58.5			89.1				35.6			
Peak Hour Factor	0.94	0.94	0.94	0.94	0.94	0.94	0.94	0.94	0.94	0.94	0.94	0.94
Adj. Flow (vph)	387	859	245	113	528	201	1	207	2600	216	6	187
Shared Lane Traffic (%)												
Lane Group Flow (vph)	387	1104	0	113	729	0	0	208	2816	0	0	193
Enter Blocked Intersection	No	No	No	No	No	No	No	No	No	No	No	No
Lane Alignment	Left	Left	Right	Left	Left	Right	R NA	Left	Left	Right	R NA	Left
Median Width(ft)		24			24				24			
Link Offset(ft)		0			0				0			
Crosswalk Width(ft)		16			16				16			
Two way Left Turn Lane												
Headway Factor	1.00	1.00	1.00	1.00	1.00	1.00	1.00	1.00	1.00	1.00	1.00	1.00
Turning Speed (mph)	15		9	15		9	9	15		9	9	15
Number of Detectors	1	1		1	1		1	1	1	1	1	1
Detector Template												
Leading Detector (ft)	50	50		50	50		50	50	50		50	50
Trailing Detector (ft)	0	0		0	0		0	0	0		0	0
Detector 1 Position(ft)	0	0		0	0		0	0	0		0	0
Detector 1 Size(ft)	50	50		50	50		50	50	50		50	50
Detector 1 Type	CI+Ex	CI+Ex		CI+Ex	CI+Ex		CI+Ex	CI+Ex	CI+Ex		CI+Ex	CI+Ex
Detector 1 Channel												
Detector 1 Extend (s)	0.0	0.0		0.0	0.0		0.0	0.0	0.0		0.0	0.0
Detector 1 Queue (s)	0.0	0.0		0.0	0.0		0.0	0.0	0.0		0.0	0.0
Detector 1 Delay (s)	0.0	0.0		0.0	0.0		0.0	0.0	0.0		0.0	0.0
Turn Type	Prot	NA		Prot	NA		Prot	Prot	NA		Prot	Prot
Protected Phases	3	8		7	4		1	1	6		5	5
Permitted Phases												
Detector Phase	3	8		7	4		1	1	6		5	5
Switch Phase												
Minimum Initial (s)	6.0	12.0		3.0	12.0		3.0	3.0	13.0		3.0	3.0
Minimum Split (s)	11.0	27.5		11.0	27.5		11.0	11.0	28.0		11.0	11.0
Total Split (s)	40.0	50.0		13.0	23.0		22.0	22.0	82.0		15.0	15.0

Pepper Square TIA  
Lanes, Volumes, Timings

Phase 1, P, & N - 2033 Background + Site - PM  
1371: Preston & Spring Valley

Lane Group	SBT	SBR
Lane Configurations	↑↑↓	
Traffic Volume (vph)	1726	226
Future Volume (vph)	1726	226
Ideal Flow (vphpl)	1900	1900
Storage Length (ft)	0	
Storage Lanes	0	
Taper Length (ft)		
Lane Util. Factor	0.91	0.91
Fr't	0.983	
Fit Protected		
Satd. Flow (prot)	4999	0
Fit Permitted		
Satd. Flow (perm)	4999	0
Right Turn on Red		Yes
Satd. Flow (RTOR)	19	
Link Speed (mph)	38	
Link Distance (ft)	1208	
Travel Time (s)	21.7	
Peak Hour Factor	0.94	0.94
Adj. Flow (vph)	1836	240
Shared Lane Traffic (%)		
Lane Group Flow (vph)	2076	0
Enter Blocked Intersection	No	No
Lane Alignment	Left	Right
Median Width(ft)	24	
Link Offset(ft)	0	
Crosswalk Width(ft)	16	
Two way Left Turn Lane		
Headway Factor	1.00	1.00
Turning Speed (mph)		9
Number of Detectors	1	
Detector Template		
Leading Detector (ft)	50	
Trailing Detector (ft)	0	
Detector 1 Position(ft)	0	
Detector 1 Size(ft)	50	
Detector 1 Type	CI+Ex	
Detector 1 Channel		
Detector 1 Extend (s)	0.0	
Detector 1 Queue (s)	0.0	
Detector 1 Delay (s)	0.0	
Turn Type	NA	
Protected Phases	2	
Permitted Phases		
Detector Phase	2	
Switch Phase		
Minimum Initial (s)	18.0	
Minimum Split (s)	28.0	
Total Split (s)	75.0	

Pepper Square TIA  
Lanes, Volumes, Timings

Phase 1, P, & N - 2033 Background + Site - PM  
1371: Preston & Spring Valley

Lane Group	EBL	EBT	EBR	WBL	WBT	WBR	NBU	NBL	NBT	NBR	SBU	SBL
Total Split (%)	25.0%	31.3%		8.1%	14.4%		13.8%	13.8%	51.3%		9.4%	9.4%
Maximum Green (s)	35.0	44.5		8.0	17.5		17.0	17.0	76.0		10.0	10.0
Yellow Time (s)	3.0	4.0		3.0	4.0		3.0	3.0	4.5		3.0	3.0
All-Red Time (s)	2.0	1.5		2.0	1.5		2.0	2.0	1.5		2.0	2.0
Lost Time Adjust (s)	-1.0	-1.5		-1.0	-1.5			-1.0	-2.0			-1.0
Total Lost Time (s)	4.0	4.0		4.0	4.0			4.0	4.0			4.0
Lead/Lag	Lead	Lead		Lag	Lag		Lead	Lead	Lead		Lag	Lag
Lead-Lag Optimize?	Yes	Yes		Yes	Yes		Yes	Yes	Yes		Yes	Yes
Vehicle Extension (s)	0.8	2.0		0.8	2.0		0.8	0.8	2.5		0.8	0.8
Recall Mode	None	Max		None	Max		None	None	None		None	None
Walk Time (s)		4.0			4.0				4.0			
Flash Dont Walk (s)		18.0			18.0				18.0			
Pedestrian Calls (#/hr)		0			0				0			
Act Effect Green (s)	22.4	46.0		9.0	32.6			13.9	78.0			11.0
Actuated g/C Ratio	0.14	0.29		0.06	0.20			0.09	0.49			0.07
v/c Ratio	0.81	0.76		0.59	0.71			0.70	1.15			0.82
Control Delay	74.7	52.4		71.0	52.2			82.9	109.8			78.9
Queue Delay	0.0	0.0		0.0	0.0			0.0	0.0			0.0
Total Delay	74.7	52.4		71.0	52.2			82.9	109.8			78.9
LOS	E	D		E	D			F	F			E
Approach Delay		58.2			54.7				107.9			
Approach LOS		E			D				F			
Queue Length 50th (ft)	202	390		62	244			114	~1231			104
Queue Length 95th (ft)	256	435		m59	m254			m158	#1309			m#154
Internal Link Dist (ft)		3179			5408				2059			
Turn Bay Length (ft)	225			225				225				275
Base Capacity (vph)	772	1445		193	1032			386	2455			236
Starvation Cap Reductn	0	0		0	0			0	0			0
Spillback Cap Reductn	0	0		0	0			0	0			0
Storage Cap Reductn	0	0		0	0			0	0			0
Reduced v/c Ratio	0.50	0.76		0.59	0.71			0.54	1.15			0.82

Intersection Summary

Area Type:	Other
Cycle Length:	160
Actuated Cycle Length:	160
Offset:	135 (84%), Referenced to phase 2:SBT, Start of Yellow
Natural Cycle:	140
Control Type:	Actuated-Coordinated
Maximum v/c Ratio:	1.15
Intersection Signal Delay:	70.2
Intersection LOS:	E
Intersection Capacity Utilization:	94.5%
ICU Level of Service:	F
Analysis Period (min):	15
~	Volume exceeds capacity, queue is theoretically infinite. Queue shown is maximum after two cycles.
#	95th percentile volume exceeds capacity, queue may be longer. Queue shown is maximum after two cycles.
m	Volume for 95th percentile queue is metered by upstream signal.

Pepper Square TIA  
Lanes, Volumes, Timings

Phase 1, P, & N - 2033 Background + Site - PM  
1371: Preston & Spring Valley

Splits and Phases: 1371: Preston & Spring Valley

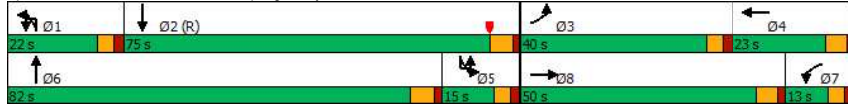

Pepper Square TIA  
Lanes, Volumes, Timings

Phase 1, P, & N - 2033 Background + Site - PM  
1371: Preston & Spring Valley

Lane Group	SBT	SBR
Total Split (%)	46.9%	
Maximum Green (s)	69.0	
Yellow Time (s)	4.5	
All-Red Time (s)	1.5	
Lost Time Adjust (s)	-2.0	
Total Lost Time (s)	4.0	
Lead/Lag	Lag	
Lead-Lag Optimize?	Yes	
Vehicle Extension (s)	2.4	
Recall Mode	C-Max	
Walk Time (s)	4.0	
Flash Dont Walk (s)	18.0	
Pedestrian Calls (#/hr)	0	
Act Effect Green (s)	75.1	
Actuated g/C Ratio	0.47	
v/c Ratio	0.88	
Control Delay	29.2	
Queue Delay	0.0	
Total Delay	29.2	
LOS	C	
Approach Delay	33.5	
Approach LOS	C	
Queue Length 50th (ft)	332	
Queue Length 95th (ft)	718	
Internal Link Dist (ft)	1128	
Turn Bay Length (ft)		
Base Capacity (vph)	2356	
Starvation Cap Reductn	0	
Spillback Cap Reductn	0	
Storage Cap Reductn	0	
Reduced v/c Ratio	0.88	
Intersection Summary		

Pepper Square TIA  
Lanes, Volumes, Timings

Phase 1, P, & N - 2033 Background + Site - PM  
1405: Prestonwood & Belt Line

Lane Group	EBU	EBL	EBT	EBR	WBU	WBL	WBT	WBR	NBL	NBT	NBR	SBL
Lane Configurations			↑↑↑↑				↑↑↑↑					↑↑
Traffic Volume (vph)	7	82	1865	7	3	2	1473	108	6	1	2	155
Future Volume (vph)	7	82	1865	7	3	2	1473	108	6	1	2	155
Ideal Flow (vphpl)	1900	1900	1900	1900	1900	1900	1900	1900	1900	1900	1900	1900
Storage Length (ft)		200		0		200		0	0		0	300
Storage Lanes		1		0		1		0	0		0	2
Taper Length (ft)		25				25		25				25
Lane Util. Factor	0.91	1.00	0.91	0.91	0.91	1.00	0.91	0.91	1.00	1.00	1.00	0.97
Fr			0.999				0.990					0.970
Fit Protected		0.950				0.950				0.968		0.950
Satd. Flow (prot)	0	1770	5080	0	0	1770	5034	0	0	1749	0	3433
Fit Permitted		0.057				0.083				0.968		0.950
Satd. Flow (perm)	0	106	5080	0	0	155	5034	0	0	1749	0	3433
Right Turn on Red			Yes				Yes			Yes		
Satd. Flow (RTOR)			1				11			2		
Link Speed (mph)			42				42			30		
Link Distance (ft)			1445				2036			315		
Travel Time (s)			23.5				33.1			7.2		
Peak Hour Factor	0.95	0.95	0.95	0.95	0.95	0.95	0.95	0.95	0.95	0.95	0.95	0.95
Adj. Flow (vph)	7	86	1963	7	3	2	1551	114	6	1	2	163
Shared Lane Traffic (%)												
Lane Group Flow (vph)	0	93	1970	0	0	5	1665	0	0	9	0	163
Enter Blocked Intersection	No	No	No	No	No	No	No	No	No	No	No	No
Lane Alignment	R NA	Left	Left	Right	R NA	Left	Left	Right	Left	Left	Right	Left
Median Width(ft)			24				24			24		
Link Offset(ft)			0				0			0		
Crosswalk Width(ft)			16				16			16		
Two way Left Turn Lane												
Headway Factor	1.00	1.00	1.00	1.00	1.00	1.00	1.00	1.00	1.00	1.00	1.00	1.00
Turning Speed (mph)	9	15		9	9	15		9	15		9	15
Number of Detectors	1	1	1		1	1	1		1	1		1
Detector Template												
Leading Detector (ft)	50	50	50		50	50	50		50	50		50
Trailing Detector (ft)	0	0	0		0	0	0		0	0		0
Detector 1 Position(ft)	0	0	0		0	0	0		0	0		0
Detector 1 Size(ft)	50	50	50		50	50	50		50	50		50
Detector 1 Type	CI+Ex	CI+Ex	CI+Ex		CI+Ex	CI+Ex	CI+Ex		CI+Ex	CI+Ex		CI+Ex
Detector 1 Channel												
Detector 1 Extend (s)	0.0	0.0	0.0		0.0	0.0	0.0		0.0	0.0		0.0
Detector 1 Queue (s)	0.0	0.0	0.0		0.0	0.0	0.0		0.0	0.0		0.0
Detector 1 Delay (s)	0.0	0.0	0.0		0.0	0.0	0.0		0.0	0.0		0.0
Turn Type	D.P+P	D.P+P	NA		D.P+P	D.P+P	NA		Split	NA		Split
Protected Phases	1	1	6		5	5	2		3	3		4
Permitted Phases	2	2			6	6						
Detector Phase	1	1	6		5	5	2		3	3		4
Switch Phase												
Minimum Initial (s)	3.0	3.0	15.0		3.0	3.0	15.0		5.0	5.0		7.0
Minimum Split (s)	8.0	8.0	22.0		8.0	8.0	24.0		23.0	23.0		23.2
Total Split (s)	25.0	25.0	99.0		15.0	15.0	89.0		18.0	18.0		28.0

Pepper Square TIA  
Lanes, Volumes, Timings

Phase 1, P, & N - 2033 Background + Site - PM  
1405: Prestonwood & Belt Line

Lane Group	SBT	SBR
Lane Configurations	↑	↑
Traffic Volume (vph)	2	85
Future Volume (vph)	2	85
Ideal Flow (vphpl)	1900	1900
Storage Length (ft)		0
Storage Lanes		1
Taper Length (ft)		
Lane Util. Factor	0.95	0.95
Fr	0.857	0.850
Fit Protected		
Satd. Flow (prot)	1517	1504
Fit Permitted		
Satd. Flow (perm)	1517	1504
Right Turn on Red		Yes
Satd. Flow (RTOR)	44	89
Link Speed (mph)	30	
Link Distance (ft)	868	
Travel Time (s)	19.7	
Peak Hour Factor	0.95	0.95
Adj. Flow (vph)	2	89
Shared Lane Traffic (%)		49%
Lane Group Flow (vph)	46	45
Enter Blocked Intersection	No	No
Lane Alignment	Left	Right
Median Width(ft)	24	
Link Offset(ft)	0	
Crosswalk Width(ft)	16	
Two way Left Turn Lane		
Headway Factor	1.00	1.00
Turning Speed (mph)		9
Number of Detectors	1	1
Detector Template		
Leading Detector (ft)	50	50
Trailing Detector (ft)	0	0
Detector 1 Position(ft)	0	0
Detector 1 Size(ft)	50	50
Detector 1 Type	CI+Ex	CI+Ex
Detector 1 Channel		
Detector 1 Extend (s)	0.0	0.0
Detector 1 Queue (s)	0.0	0.0
Detector 1 Delay (s)	0.0	0.0
Turn Type	NA	custom
Protected Phases	4	
Permitted Phases		1.4
Detector Phase	4	1.4
Switch Phase		
Minimum Initial (s)	7.0	
Minimum Split (s)	23.2	
Total Split (s)	28.0	

Pepper Square TIA  
Lanes, Volumes, Timings

Phase 1, P, & N - 2033 Background + Site - PM  
1405: Prestonwood & Belt Line

Lane Group	EBU	EBL	EBT	EBR	WBU	WBL	WBT	WBR	NBL	NBT	NBR	SBL
Total Split (%)	15.6%	15.6%	61.9%		9.4%	9.4%	55.6%		11.3%	11.3%		17.5%
Maximum Green (s)	20.0	20.0	93.0		10.0	10.0	83.0		13.0	13.0		22.8
Yellow Time (s)	3.0	3.0	4.5		3.0	3.0	4.5		3.0	3.0		3.2
All-Red Time (s)	2.0	2.0	1.5		2.0	2.0	1.5		2.0	2.0		2.0
Lost Time Adjust (s)		-1.0	-2.0			-1.0	-2.0			-1.0		-1.2
Total Lost Time (s)		4.0	4.0			4.0	4.0			4.0		4.0
Lead/Lag	Lag	Lag	Lag		Lead	Lead	Lead		Lead	Lead		Lag
Lead-Lag Optimize?	Yes	Yes	Yes		Yes	Yes	Yes		Yes	Yes		Yes
Vehicle Extension (s)	1.0	1.0	2.5		1.0	1.0	2.5		1.5	1.5		1.5
Recall Mode	None	None	C-Max		None	None	None		None	None		None
Walk Time (s)			5.0				4.0		4.0	4.0		4.0
Flash Dont Walk (s)			10.0				14.0		14.0	14.0		14.0
Pedestrian Calls (#/hr)			0				0		0	0		0
Act Effect Green (s)		131.0	133.3			134.2	78.9			6.3		12.7
Actuated g/C Ratio		0.82	0.83			0.84	0.49			0.04		0.08
v/c Ratio		0.15	0.47			0.03	0.67			0.13		0.60
Control Delay		22.9	5.5			1.0	20.7			67.0		80.2
Queue Delay		0.0	0.0			0.0	0.0			0.0		0.0
Total Delay		22.9	5.5			1.0	20.7			67.0		80.2
LOS		C	A			A	C			E		F
Approach Delay			6.3				20.7			67.0		
Approach LOS			A				C			E		
Queue Length 50th (ft)		14	61			0	290			7		86
Queue Length 95th (ft)		73	473			m1	m296			28		125
Internal Link Dist (ft)			1365				1956			235		
Turn Bay Length (ft)		200				200						300
Base Capacity (vph)		628	4231			241	2679			154		514
Starvation Cap Reductn		0	0			0	0			0		0
Spillback Cap Reductn		0	0			0	0			0		0
Storage Cap Reductn		0	0			0	0			0		0
Reduced v/c Ratio		0.15	0.47			0.02	0.62			0.06		0.32

Intersection Summary

Area Type: Other  
 Cycle Length: 160  
 Actuated Cycle Length: 160  
 Offset: 60 (38%), Referenced to phase 6:EBWB, Start of Yellow  
 Natural Cycle: 90  
 Control Type: Actuated-Coordinated  
 Maximum v/c Ratio: 0.67  
 Intersection Signal Delay: 15.6 Intersection LOS: B  
 Intersection Capacity Utilization 56.8% ICU Level of Service B  
 Analysis Period (min) 15  
 m Volume for 95th percentile queue is metered by upstream signal.

Splits and Phases: 1405: Prestonwood & Belt Line

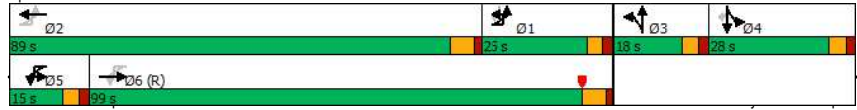

Kimley-Horn

Pepper Square TIA  
Lanes, Volumes, Timings

Phase 1, P, & N - 2033 Background + Site - PM  
1405: Prestonwood & Belt Line

Lane Group	SBT	SBR
Total Split (%)	17.5%	
Maximum Green (s)	22.8	
Yellow Time (s)	3.2	
All-Red Time (s)	2.0	
Lost Time Adjust (s)	-1.2	
Total Lost Time (s)	4.0	
Lead/Lag	Lag	
Lead-Lag Optimize?	Yes	
Vehicle Extension (s)	1.5	
Recall Mode	None	
Walk Time (s)	4.0	
Flash Dont Walk (s)	14.0	
Pedestrian Calls (#/hr)	0	
Act Effect Green (s)	12.7	67.2
Actuated g/C Ratio	0.08	0.42
v/c Ratio	0.29	0.07
Control Delay	23.0	0.2
Queue Delay	0.0	0.0
Total Delay	23.0	0.2
LOS	C	A
Approach Delay	55.6	
Approach LOS	E	
Queue Length 50th (ft)	2	0
Queue Length 95th (ft)	46	0
Internal Link Dist (ft)	788	
Turn Bay Length (ft)		
Base Capacity (vph)	264	783
Starvation Cap Reductn	0	0
Spillback Cap Reductn	0	0
Storage Cap Reductn	0	0
Reduced v/c Ratio	0.17	0.06

Intersection Summary

09/26/2022 4:53 pm  
Kimley-Horn

Pepper Square TIA  
HCM 6th TWSC

Phase 1, P, & N - 2033 Background + Site - PM  
2: Ladera Drive & Belt Line

Intersection												
Int Delay, s/veh	766.8											
Movement	EBL	EBT	EBR	WBL	WBT	WBR	NBL	NBT	NBR	SBL	SBT	SBR
Lane Configurations	↔ ↑↑↑			↔ ↑↑↑			↔ ↑↑			↔ ↑↑		
Traffic Vol, veh/h	183	1837	58	79	1422	129	17	1	50	72	1	119
Future Vol, veh/h	183	1837	58	79	1422	129	17	1	50	72	1	119
Conflicting Peds, #/hr	0	0	0	0	0	0	0	0	0	0	0	0
Sign Control	Free	Free	Free	Free	Free	Stop	Stop	Stop	Stop	Stop	Stop	Stop
RT Channelized	-	-	None	-	-	None	-	-	None	-	-	None
Storage Length	100	-	-	100	-	-	-	-	0	-	-	0
Veh in Median Storage, #	-	0	-	-	0	-	-	-	1	-	-	1
Grade, %	-	0	-	-	0	-	-	-	0	-	-	0
Peak Hour Factor	96	96	96	96	96	96	96	96	96	96	96	96
Heavy Vehicles, %	2	2	2	2	2	2	2	2	2	2	2	2
Mvmt Flow	191	1914	60	82	1481	134	18	1	52	75	1	124

Major/Minor	Major1	Major2	Minor1	Minor2
Conflicting Flow All	1615	0	0	1974
Stage 1	-	-	-	-
Stage 2	-	-	-	-
Critical Hdwy	5.34	-	-	5.34
Critical Hdwy Stg 1	-	-	-	-
Critical Hdwy Stg 2	-	-	-	-
Follow-up Hdwy	3.12	-	-	3.12
Pot Cap-1 Maneuver	195	-	-	*619
Stage 1	-	-	-	-
Stage 2	-	-	-	-
Platoon blocked, %	-	-	-	-
Mov Cap-1 Maneuver	195	-	-	*619
Mov Cap-2 Maneuver	-	-	-	-
Stage 1	-	-	-	-
Stage 2	-	-	-	-

Approach	EB	WB	NB	SB
HCM Control Delay, s	9.6	0.6	\$ 700	\$ 15490
HCM LOS			F	F

Minor Lane/Major Mvmt	NBLn1	NBLn2	EBL	EBT	EBR	WBL	WBT	WBR	SBLn1	SBLn2
Capacity (veh/h)	5	493	195	-	-	* 619	-	-	1	278
HCM Lane V/C Ratio	3.75	0.106	0.978	-	-	0.133	-	-	-76.042	0.446
HCM Control Delay (s)	\$ 2607.8	13.2	108.7	-	-	11.7	-	-	\$ 40695.1	28
HCM Lane LOS	F	B	F	-	-	B	-	-	F	D
HCM 95th %tile Q(veh)	3.6	0.4	8.2	-	-	0.5	-	-	11.8	2.2

Notes  
 ~: Volume exceeds capacity    \$: Delay exceeds 300s    +: Computation Not Defined    \*: All major volume in platoon

Pepper Square TIA  
HCM 6th TWSC

Phase 1, P, & N - 2033 Background + Site - PM  
3: Median Opening East of Preston Rd & Belt Line

Intersection												
Int Delay, s/veh	1											
Movement	EBU	EBL	EBT	EBR	WBU	WBL	WBT	WBR	NBL	NBT	NBR	SBL
Lane Configurations	↔ ↑↑↑			↔ ↑↑↑			↔ ↑↑			↔ ↑↑		
Traffic Vol, veh/h	6	6	1320	37	1	29	1031	5	8	0	30	21
Future Vol, veh/h	6	6	1320	37	1	29	1031	5	8	0	30	21
Conflicting Peds, #/hr	0	0	0	0	0	0	0	0	0	0	0	0
Sign Control	Free	Free	Free	Free	Free	Free	Free	Free	Stop	Stop	Stop	Stop
RT Channelized	-	-	-	None	-	-	-	None	-	-	None	-
Storage Length	-	150	-	-	-	200	-	-	-	-	-	-
Veh in Median Storage, #	-	-	0	-	-	0	-	-	-	1	-	-
Grade, %	-	-	0	-	-	0	-	-	-	0	-	-
Peak Hour Factor	93	93	93	93	93	93	93	93	93	93	93	93
Heavy Vehicles, %	2	2	2	2	2	2	2	2	2	2	2	2
Mvmt Flow	6	6	1419	40	1	31	1109	5	9	0	32	23

Major/Minor	Major1	Major2	Minor1	Minor2
Conflicting Flow All	813	1114	0	0
Stage 1	-	-	-	-
Stage 2	-	-	-	-
Critical Hdwy	5.64	5.34	-	-
Critical Hdwy Stg 1	-	-	-	-
Critical Hdwy Stg 2	-	-	-	-
Follow-up Hdwy	2.32	3.12	-	-
Pot Cap-1 Maneuver	*1161	*864	-	-
Stage 1	-	-	-	-
Stage 2	-	-	-	-
Platoon blocked, %	1	1	-	-
Mov Cap-1 Maneuver	*977	*977	-	-
Mov Cap-2 Maneuver	-	-	-	-
Stage 1	-	-	-	-
Stage 2	-	-	-	-

Approach	EB	WB	NB	SB
HCM Control Delay, s	0.1	0.6	28.4	15.9
HCM LOS			D	C

Minor Lane/Major Mvmt	NBLn1	EBL	EBT	EBR	WBL	WBT	WBR	SBLn1
Capacity (veh/h)	194	* 977	-	-	236	-	-	376
HCM Lane V/C Ratio	0.211	0.013	-	-	0.137	-	-	0.126
HCM Control Delay (s)	28.4	8.7	-	-	22.7	-	-	15.9
HCM Lane LOS	D	A	-	-	C	-	-	C
HCM 95th %tile Q(veh)	0.8	0	-	-	0.5	-	-	0.4

Notes  
 ~: Volume exceeds capacity    \$: Delay exceeds 300s    +: Computation Not Defined    \*: All major volume in platoon

Pepper Square TIA  
HCM 6th TWSC

Phase 1, P, & N - 2033 Background + Site - PM  
5: Belt Line & Median between Berry Trail and Alexis Dr

Intersection												
Int Delay, s/veh	0.6											
Movement	EBL	EBT	EBR	WBL	WBT	WBR	NBL	NBT	NBR	SBL	SBT	SBR
Lane Configurations	↔ ↑↑↑			↔ ↑↑↑			↔			↔		
Traffic Vol, veh/h	8	1390	26	59	1037	13	11	4	40	4	1	7
Future Vol, veh/h	8	1390	26	59	1037	13	11	4	40	4	1	7
Conflicting Peds, #/hr	0	0	0	0	0	0	0	0	0	0	0	0
Sign Control	Free	Free	Free	Free	Free	Stop	Stop	Stop	Stop	Stop	Stop	Stop
RT Channelized	-	-	None	-	-	None	-	-	None	-	-	None
Storage Length	150	-	-	150	-	-	-	-	-	-	-	-
Veh in Median Storage, #	-	0	-	-	0	-	-	1	-	-	1	-
Grade, %	-	0	-	-	0	-	-	0	-	-	0	-
Peak Hour Factor	94	94	94	94	94	94	94	94	94	94	94	94
Heavy Vehicles, %	2	2	2	2	2	2	2	2	2	2	2	2
Mvmt Flow	9	1479	28	63	1103	14	12	4	43	4	1	7

Major/Minor	Major1	Major2	Minor1	Minor2
Conflicting Flow All	1117	0	0	1507
Stage 1	-	-	-	-
Stage 2	-	-	-	-
Critical Hdwy	5.34	-	-	5.34
Critical Hdwy Stg 1	-	-	-	-
Critical Hdwy Stg 2	-	-	-	-
Follow-up Hdwy	3.12	-	-	3.12
Pot Cap-1 Maneuver	*864	-	-	*762
Stage 1	-	-	-	-
Stage 2	-	-	-	-
Platoon blocked, %	1	-	-	1
Mov Cap-1 Maneuver	*864	-	-	*762
Mov Cap-2 Maneuver	-	-	-	-
Stage 1	-	-	-	-
Stage 2	-	-	-	-

Approach	EB	WB	NB	SB
HCM Control Delay, s	0.1	0.5	12.5	12.1
HCM LOS			B	B

Minor Lane/Major Mvmt	NBLn1	EBL	EBT	EBR	WBL	WBT	WBR	SBLn1
Capacity (veh/h)	538	*864	-	-	*762	-	-	519
HCM Lane V/C Ratio	0.109	0.01	-	-	0.082	-	-	0.025
HCM Control Delay (s)	12.5	9.2	-	-	10.1	-	-	12.1
HCM Lane LOS	B	A	-	-	B	-	-	B
HCM 95th %tile Q(veh)	0.4	0	-	-	0.3	-	-	0.1

Notes  
 ~: Volume exceeds capacity    \$: Delay exceeds 300s    +: Computation Not Defined    \*: All major volume in platoon

Pepper Square TIA  
HCM 6th TWSC

Phase 1, P, & N - 2033 Background + Site - PM  
6: Alexis Drive & Belt Line

Intersection						
Int Delay, s/veh	3.4					
Movement	EBT	EBR	WBL	WBT	NBL	NBR
Lane Configurations	↑↑↑		↔ ↑↑↑		↔	
Traffic Vol, veh/h	1392	29	305	1092	7	342
Future Vol, veh/h	1392	29	305	1092	7	342
Conflicting Peds, #/hr	0	0	0	0	0	0
Sign Control	Free	Free	Free	Free	Stop	Stop
RT Channelized	-	None	-	None	-	Yield
Storage Length	-	-	150	-	0	0
Veh in Median Storage, #	0	-	-	0	1	-
Grade, %	0	-	-	0	0	-
Peak Hour Factor	95	95	95	95	95	95
Heavy Vehicles, %	2	2	2	2	2	2
Mvmt Flow	1465	31	321	1149	7	360

Major/Minor	Major1	Major2	Minor1
Conflicting Flow All	0	0	1496
Stage 1	-	-	-
Stage 2	-	-	-
Critical Hdwy	-	-	5.34
Critical Hdwy Stg 1	-	-	-
Critical Hdwy Stg 2	-	-	-
Follow-up Hdwy	-	-	3.12
Pot Cap-1 Maneuver	-	-	*762
Stage 1	-	-	-
Stage 2	-	-	-
Platoon blocked, %	-	-	1
Mov Cap-1 Maneuver	-	-	*762
Mov Cap-2 Maneuver	-	-	-
Stage 1	-	-	-
Stage 2	-	-	-

Approach	EB	WB	NB
HCM Control Delay, s	0	2.9	19.2
HCM LOS			C

Minor Lane/Major Mvmt	NBLn1	NBLn2	EBT	EBR	WBL	WBT
Capacity (veh/h)	312	606	-	-	*762	-
HCM Lane V/C Ratio	0.024	0.594	-	-	0.421	-
HCM Control Delay (s)	16.8	19.3	-	-	13.1	-
HCM Lane LOS	C	C	-	-	B	-
HCM 95th %tile Q(veh)	0.1	3.9	-	-	2.1	-

Notes  
 ~: Volume exceeds capacity    \$: Delay exceeds 300s    +: Computation Not Defined    \*: All major volume in platoon

Pepper Square TIA  
HCM 6th TWSC

Phase 1, P, & N - 2033 Background + Site - PM  
10: Preston & Pepper Square Driveway

Intersection													
Int Delay, s/veh													
Movement	EBL	EBT	EBR	WBL	WBT	WBR	NBL	NBT	NBR	SBL	SBT	SBR	
Lane Configurations		↔			↔	↔		↔↔↔			↔↔↔		
Traffic Vol, veh/h	12	5	63	10	2	77	4	98	2511	62	6	24	2058
Future Vol, veh/h	12	5	63	10	2	77	4	98	2511	62	6	24	2058
Conflicting Peds, #/hr	0	0	0	0	0	0	0	0	0	0	0	0	0
Sign Control	Stop	Stop	Stop	Stop	Stop	Free	Free	Free	Free	Free	Free	Free	Free
RT Channelized	-	-	None	-	-	None	-	-	None	-	-	-	None
Storage Length	-	-	-	-	0	-	150	-	-	150	-	-	-
Veh in Median Storage, #	-	1	-	-	1	-	-	0	-	-	0	-	0
Grade, %	-	0	-	-	0	-	-	0	-	-	0	-	-
Peak Hour Factor	97	97	97	97	97	97	97	97	97	97	97	97	97
Heavy Vehicles, %	2	2	2	2	2	2	2	2	2	2	2	2	2
Mvmt Flow	12	5	65	10	2	79	4	101	2589	64	6	25	2122

Major/Minor	Minor2	Minor1	Major1	Major2									
Conflicting Flow All	3468	5084	1098	3744	5088	1327	1602	2195	0	0	1936	2653	0
Stage 1	2221	2221	-	2831	2831	-	-	-	-	-	-	-	-
Stage 2	1247	2863	-	913	2257	-	-	-	-	-	-	-	-
Critical Hdwy	6.44	6.54	7.14	6.44	6.54	7.14	5.64	5.34	-	-	5.64	5.34	-
Critical Hdwy Stg 1	7.34	5.54	-	7.34	5.54	-	-	-	-	-	-	-	-
Critical Hdwy Stg 2	6.74	5.54	-	6.74	5.54	-	-	-	-	-	-	-	-
Follow-up Hdwy	3.82	4.02	3.92	3.82	4.02	3.92	2.32	3.12	-	-	2.32	3.12	-
Pot Cap-1 Maneuver	*18	*0	*444	*~8	*0	125	*751	*558	-	-	131	58	-
Stage 1	*456	*433	-	*~9	*38	-	-	-	-	-	-	-	-
Stage 2	*165	*36	-	*456	*433	-	-	-	-	-	-	-	-
Platoon blocked, %	1	1	1	1	1	1	1	1	-	-	-	-	-
Mov Cap-1 Maneuver	*~3	*0	*444	*~3	*0	125	*561	*561	-	-	56	56	-
Mov Cap-2 Maneuver	*13	-	-	*~6	*21	-	-	-	-	-	-	-	-
Stage 1	*371	*194	-	*~7	*31	-	-	-	-	-	-	-	-
Stage 2	*46	*29	-	*170	*194	-	-	-	-	-	-	-	-

Approach	EB	WB	NB	SB
HCM Control Delay, s	~	246.7	0.5	1.8
HCM LOS	-	F		

Minor Lane/Major Mvmt	NBL	NBT	NBR	EBLn1	WBLn1	WBLn2	SBL	SBT	SBR
Capacity (veh/h)	*561	-	-	~	7	125	56	-	-
HCM Lane V/C Ratio	0.187	-	-	~	1.767	0.635	0.552	-	-
HCM Control Delay (s)	12.9	-	-	\$	1354.4	74.1	129.4	-	-
HCM Lane LOS	B	-	-	F	F	F	-	-	-
HCM 95th %tile Q(veh)	0.7	-	-	~	2.5	3.3	2.2	-	-

Notes  
 ~: Volume exceeds capacity    \$: Delay exceeds 300s    +: Computation Not Defined    \*: All major volume in platoon

Pepper Square TIA  
HCM 6th TWSC

Phase 1, P, & N - 2033 Background + Site - PM  
20: Preston & Drive 2

Intersection						
Int Delay, s/veh						
Movement	WBL	WBR	NBT	NBR	SBL	SBT
Lane Configurations		↔↔↔	↔↔↔			↔↔↔
Traffic Vol, veh/h	0	37	2556	35	0	2248
Future Vol, veh/h	0	37	2556	35	0	2248
Conflicting Peds, #/hr	0	0	0	0	0	0
Sign Control	Stop	Stop	Free	Free	Free	Free
RT Channelized	-	None	-	None	-	None
Storage Length	-	0	-	-	-	-
Veh in Median Storage, #	0	-	0	-	-	0
Grade, %	0	-	0	-	-	0
Peak Hour Factor	95	95	95	95	95	95
Heavy Vehicles, %	2	2	2	2	2	2
Mvmt Flow	0	39	2691	37	0	2366

Major/Minor	Minor1	Major1	Major2				
Conflicting Flow All	-	1364	0	0	-	-	-
Stage 1	-	-	-	-	-	-	-
Stage 2	-	-	-	-	-	-	-
Critical Hdwy	-	7.14	-	-	-	-	-
Critical Hdwy Stg 1	-	-	-	-	-	-	-
Critical Hdwy Stg 2	-	-	-	-	-	-	-
Follow-up Hdwy	-	3.92	-	-	-	-	-
Pot Cap-1 Maneuver	0	118	-	-	0	-	-
Stage 1	0	-	-	-	0	-	-
Stage 2	0	-	-	-	0	-	-
Platoon blocked, %	-	-	-	-	-	-	-
Mov Cap-1 Maneuver	-	118	-	-	-	-	-
Mov Cap-2 Maneuver	-	-	-	-	-	-	-
Stage 1	-	-	-	-	-	-	-
Stage 2	-	-	-	-	-	-	-

Approach	WB	NB	SB
HCM Control Delay, s	49.9	0	0
HCM LOS	E		

Minor Lane/Major Mvmt	NBT	NBR	WBLn1	SBT
Capacity (veh/h)	-	-	118	-
HCM Lane V/C Ratio	-	-	0.33	-
HCM Control Delay (s)	-	-	49.9	-
HCM Lane LOS	-	-	E	-
HCM 95th %tile Q(veh)	-	-	1.3	-



Pepper Square TIA  
HCM 6th TWSC

Phase 1, P, & N - 2033 Background + Site - PM  
21: Preston & Drive 1

Intersection						
Int Delay, s/veh	0					
Movement	WBL	WBR	NBT	NBR	SBL	SBT
Lane Configurations		↑ ↑ ↑	↑ ↑ ↑			↑ ↑ ↑
Traffic Vol, veh/h	0	2	2676	2	0	2080
Future Vol, veh/h	0	2	2676	2	0	2080
Conflicting Peds, #/hr	0	0	0	0	0	0
Sign Control	Stop	Stop	Free	Free	Free	Free
RT Channelized	-	None	-	None	-	None
Storage Length	-	0	-	-	-	-
Veh in Median Storage, #	0	-	0	-	0	0
Grade, %	0	-	0	-	0	0
Peak Hour Factor	95	95	95	95	95	95
Heavy Vehicles, %	2	2	2	2	2	2
Mvmt Flow	0	2	2817	2	0	2189

Major/Minor	Minor1	Major1	Major2		
Conflicting Flow All	-	1410	0	0	-
Stage 1	-	-	-	-	-
Stage 2	-	-	-	-	-
Critical Hdwy	-	7.14	-	-	-
Critical Hdwy Stg 1	-	-	-	-	-
Critical Hdwy Stg 2	-	-	-	-	-
Follow-up Hdwy	-	3.92	-	-	-
Pot Cap-1 Maneuver	0	110	-	0	-
Stage 1	0	-	-	0	-
Stage 2	0	-	-	0	-
Platoon blocked, %	-	-	-	-	-
Mov Cap-1 Maneuver	-	110	-	-	-
Mov Cap-2 Maneuver	-	-	-	-	-
Stage 1	-	-	-	-	-
Stage 2	-	-	-	-	-

Approach	WB	NB	SB
HCM Control Delay, s	38.4	0	0
HCM LOS	E		

Minor Lane/Major Mvmt	NBT	NBRWBLn1	SBT
Capacity (veh/h)	-	-	110
HCM Lane V/C Ratio	-	-	0.019
HCM Control Delay (s)	-	-	38.4
HCM Lane LOS	-	-	E
HCM 95th %tile Q(veh)	-	-	0.1

Pepper Square TIA  
HCM 6th TWSC

Phase 1, P, & N - 2033 Background + Site - PM  
22: Drive 6 & Belt Line

Intersection						
Int Delay, s/veh	0.3					
Movement	EBT	EBR	WBL	WBT	NBL	NBR
Lane Configurations	↑ ↑ ↑			↑ ↑ ↑		↑
Traffic Vol, veh/h	1373	32	0	1062	0	36
Future Vol, veh/h	1373	32	0	1062	0	36
Conflicting Peds, #/hr	0	0	0	0	0	0
Sign Control	Free	Free	Free	Free	Stop	Stop
RT Channelized	-	None	-	None	-	None
Storage Length	-	-	-	-	-	0
Veh in Median Storage, #	0	-	-	0	0	-
Grade, %	0	-	-	0	0	-
Peak Hour Factor	93	93	93	93	93	93
Heavy Vehicles, %	2	2	2	2	2	2
Mvmt Flow	1476	34	0	1142	0	39

Major/Minor	Major1	Major2	Minor1		
Conflicting Flow All	0	0	-	-	755
Stage 1	-	-	-	-	-
Stage 2	-	-	-	-	-
Critical Hdwy	-	-	-	-	7.14
Critical Hdwy Stg 1	-	-	-	-	-
Critical Hdwy Stg 2	-	-	-	-	-
Follow-up Hdwy	-	-	-	-	3.92
Pot Cap-1 Maneuver	-	-	0	-	301
Stage 1	-	-	0	-	0
Stage 2	-	-	0	-	0
Platoon blocked, %	-	-	-	-	-
Mov Cap-1 Maneuver	-	-	-	-	301
Mov Cap-2 Maneuver	-	-	-	-	-
Stage 1	-	-	-	-	-
Stage 2	-	-	-	-	-

Approach	EB	WB	NB
HCM Control Delay, s	0	0	18.7
HCM LOS			C

Minor Lane/Major Mvmt	NBLn1	EBT	EBR	WBT
Capacity (veh/h)	301	-	-	-
HCM Lane V/C Ratio	0.129	-	-	-
HCM Control Delay (s)	18.7	-	-	-
HCM Lane LOS	C	-	-	-
HCM 95th %tile Q(veh)	0.4	-	-	-

Pepper Square TIA  
HCM 6th TWSC

Phase 1, P, & N - 2033 Background + Site - PM  
24: Drive 5 & Belt Line

Intersection						
Int Delay, s/veh	0.2					
Movement	EBT	EBR	WBL	WBT	NBL	NBR
Lane Configurations	↑↑↑			↑↑↑		↑
Traffic Vol, veh/h	1346	24	0	1006	0	33
Future Vol, veh/h	1346	24	0	1006	0	33
Conflicting Peds, #/hr	0	0	0	0	0	0
Sign Control	Free	Free	Free	Free	Stop	Stop
RT Channelized	-	None	-	None	-	None
Storage Length	-	-	-	-	-	0
Veh in Median Storage, #	0	-	-	0	0	-
Grade, %	0	-	-	0	0	-
Peak Hour Factor	93	93	93	93	93	93
Heavy Vehicles, %	2	2	2	2	2	2
Mvmt Flow	1447	26	0	1082	0	35

Major/Minor	Major1	Major2	Minor1
Conflicting Flow All	0	0	- 737
Stage 1	-	-	-
Stage 2	-	-	-
Critical Hdwy	-	-	- 7.14
Critical Hdwy Stg 1	-	-	-
Critical Hdwy Stg 2	-	-	-
Follow-up Hdwy	-	-	- 3.92
Pot Cap-1 Maneuver	-	0	- 0 310
Stage 1	-	0	- 0
Stage 2	-	0	- 0
Platoon blocked, %	-	-	-
Mov Cap-1 Maneuver	-	-	- 310
Mov Cap-2 Maneuver	-	-	-
Stage 1	-	-	-
Stage 2	-	-	-

Approach	EB	WB	NB
HCM Control Delay, s	0	0	18.1
HCM LOS			C

Minor Lane/Major Mvmt	NBLn1	EBT	EBR	WBT
Capacity (veh/h)	310	-	-	-
HCM Lane V/C Ratio	0.114	-	-	-
HCM Control Delay (s)	18.1	-	-	-
HCM Lane LOS	C	-	-	-
HCM 95th %tile Q(veh)	0.4	-	-	-

Pepper Square TIA  
HCM 6th TWSC

Phase 1, P, & N - 2033 Background + Site - PM  
25: Preston & Drive 4

Intersection						
Int Delay, s/veh	0.3					
Movement	WBL	WBR	NBT	NBR	SBL	SBT
Lane Configurations		↑↑↑	↑↑↑			↑↑↑
Traffic Vol, veh/h	0	31	2636	34	0	2253
Future Vol, veh/h	0	31	2636	34	0	2253
Conflicting Peds, #/hr	0	0	0	0	0	0
Sign Control	Stop	Stop	Free	Free	Free	Free
RT Channelized	-	None	-	None	-	None
Storage Length	-	0	-	-	-	-
Veh in Median Storage, #	0	-	0	-	-	0
Grade, %	0	-	0	-	-	0
Peak Hour Factor	95	95	95	95	95	95
Heavy Vehicles, %	2	2	2	2	2	2
Mvmt Flow	0	33	2775	36	0	2372

Major/Minor	Minor1	Major1	Major2
Conflicting Flow All	- 1406	0	0 -
Stage 1	-	-	-
Stage 2	-	-	-
Critical Hdwy	- 7.14	-	-
Critical Hdwy Stg 1	-	-	-
Critical Hdwy Stg 2	-	-	-
Follow-up Hdwy	- 3.92	-	-
Pot Cap-1 Maneuver	0 110	-	- 0 -
Stage 1	0	-	- 0 -
Stage 2	0	-	- 0 -
Platoon blocked, %	-	-	-
Mov Cap-1 Maneuver	- 110	-	-
Mov Cap-2 Maneuver	-	-	-
Stage 1	-	-	-
Stage 2	-	-	-

Approach	WB	NB	SB
HCM Control Delay, s	51	0	0
HCM LOS	F		

Minor Lane/Major Mvmt	NBT	NBRWBLn1	SBT
Capacity (veh/h)	-	- 110	-
HCM Lane V/C Ratio	-	- 0.297	-
HCM Control Delay (s)	-	- 51	-
HCM Lane LOS	-	- F	-
HCM 95th %tile Q(veh)	-	- 1.1	-

Intersection						
Int Delay, s/veh	0.7					
Movement	WBL	WBR	NBT	NBR	SBL	SBT
Lane Configurations			↑ ↑ ↑ ↑			↑ ↑ ↑ ↑
Traffic Vol, veh/h	0	51	2640	45	0	2253
Future Vol, veh/h	0	51	2640	45	0	2253
Conflicting Peds, #/hr	0	0	0	0	0	0
Sign Control	Stop	Stop	Free	Free	Free	Free
RT Channelized	-	None	-	None	-	None
Storage Length	-	0	-	-	-	-
Veh in Median Storage, #	0	-	0	-	-	0
Grade, %	0	-	0	-	-	0
Peak Hour Factor	95	95	95	95	95	95
Heavy Vehicles, %	2	2	2	2	2	2
Mvmt Flow	0	54	2779	47	0	2372

Major/Minor	Minor1	Major1	Major2		
Conflicting Flow All	-	1413	0	0	-
Stage 1	-	-	-	-	-
Stage 2	-	-	-	-	-
Critical Hdwy	-	7.14	-	-	-
Critical Hdwy Stg 1	-	-	-	-	-
Critical Hdwy Stg 2	-	-	-	-	-
Follow-up Hdwy	-	3.92	-	-	-
Pot Cap-1 Maneuver	0	109	-	-	0
Stage 1	0	-	-	-	0
Stage 2	0	-	-	-	0
Platoon blocked, %	-	-	-	-	-
Mov Cap-1 Maneuver	-	109	-	-	-
Mov Cap-2 Maneuver	-	-	-	-	-
Stage 1	-	-	-	-	-
Stage 2	-	-	-	-	-

Approach	WB	NB	SB
HCM Control Delay, s	66.5	0	0
HCM LOS	F		

Minor Lane/Major Mvmt	NBT	NBRWBLn1	SBT
Capacity (veh/h)	-	-	109
HCM Lane V/C Ratio	-	-	0.493
HCM Control Delay (s)	-	-	66.5
HCM Lane LOS	-	-	F
HCM 95th %tile Q(veh)	-	-	2.2

**Synchro™ Output - 2033 Background Plus Site-Generated  
Traffic – Phases 1, P and N – Drive 4 Removed**

Pepper Square TIA Phase 1, P, & N - 2033 Background + Site - AM - Drive 4 Removed  
 Lanes, Volumes, Timings 25: Preston & Drive 4



Lane Group	WBL	WBR	NBT	NBR	SBL	SBT
Lane Configurations		↗ ↘	↕	↘	↖	↕
Traffic Volume (vph)	0	0	2156	0	0	2333
Future Volume (vph)	0	0	2156	0	0	2333
Ideal Flow (vphpl)	1900	1900	1900	1900	1900	1900
Lane Util. Factor	1.00	1.00	0.91	0.91	1.00	0.91
Frt						
Flt Protected						
Satd. Flow (prot)	0	1863	5085	0	0	5085
Flt Permitted						
Satd. Flow (perm)	0	1863	5085	0	0	5085
Link Speed (mph)	30		42			38
Link Distance (ft)	173		221			261
Travel Time (s)	3.9		3.6			4.7
Peak Hour Factor	0.92	0.92	0.92	0.92	0.92	0.92
Adj. Flow (vph)	0	0	2343	0	0	2536
Shared Lane Traffic (%)						
Lane Group Flow (vph)	0	0	2343	0	0	2536
Enter Blocked Intersection	No	No	No	No	No	No
Lane Alignment	Left	Right	Left	Right	Left	Left
Median Width(ft)	0		24			24
Link Offset(ft)	0		0			0
Crosswalk Width(ft)	16		16			16
Two way Left Turn Lane						
Headway Factor	1.00	1.00	1.00	1.00	1.00	1.00
Turning Speed (mph)	15	9		9	15	
Sign Control	Stop		Free			Free

Intersection Summary	
Area Type:	Other
Control Type:	Unsignalized
Intersection Capacity Utilization	48.4%
Analysis Period (min)	15
	ICU Level of Service A

Pepper Square TIA Phase 1, P, & N - 2033 Background + Site - AM - Drive 4 Removed  
 HCM 6th TWSC 25: Preston & Drive 4

Intersection						
Int Delay, s/veh	0					
Movement	WBL	WBR	NBT	NBR	SBL	SBT
Lane Configurations		↗ ↘	↕	↘	↖	↕
Traffic Vol, veh/h	0	0	2156	0	0	2333
Future Vol, veh/h	0	0	2156	0	0	2333
Conflicting Peds, #/hr	0	0	0	0	0	0
Sign Control	Stop	Stop	Free	Free	Free	Free
RT Channelized	-	None	-	None	-	None
Storage Length	-	0	-	-	-	-
Veh in Median Storage, #	0	-	0	-	-	0
Grade, %	0	-	0	-	-	0
Peak Hour Factor	92	92	92	92	92	92
Heavy Vehicles, %	2	2	2	2	2	2
Mvmt Flow	0	0	2343	0	0	2536

Major/Minor	Minor1	Major1	Major2
Conflicting Flow All	- 1172	0	0
Stage 1	-	-	-
Stage 2	-	-	-
Critical Hdwy	- 7.14	-	-
Critical Hdwy Stg 1	-	-	-
Critical Hdwy Stg 2	-	-	-
Follow-up Hdwy	- 3.92	-	-
Pot Cap-1 Maneuver	0	159	-
Stage 1	0	-	-
Stage 2	0	-	-
Platoon blocked, %	-	-	-
Mov Cap-1 Maneuver	-	159	-
Mov Cap-2 Maneuver	-	-	-
Stage 1	-	-	-
Stage 2	-	-	-

Approach	WB	NB	SB
HCM Control Delay, s	0	0	0
HCM LOS	A		

Minor Lane/Major Mvmt	NBT	NBRWBLn1	SBT
Capacity (veh/h)	-	-	-
HCM Lane V/C Ratio	-	-	-
HCM Control Delay (s)	-	0	-
HCM Lane LOS	-	A	-
HCM 95th %tile Q(veh)	-	-	-

Pepper Square TIA Phase 1, P, & N - 2033 Background + Site - AM - Drive 4 Removed  
Lanes, Volumes, Timings 26: Preston & Drive 3



Lane Group	WBL	WBR	NBT	NBR	SBL	SBT
Lane Configurations		↔	↔↔↔			↔↔↔
Traffic Volume (vph)	0	34	2128	29	0	2333
Future Volume (vph)	0	34	2128	29	0	2333
Ideal Flow (vphpl)	1900	1900	1900	1900	1900	1900
Lane Util. Factor	1.00	1.00	0.91	0.91	1.00	0.91
Frt		0.865	0.998			
Flt Protected						
Satd. Flow (prot)	0	1611	5075	0	0	5085
Flt Permitted						
Satd. Flow (perm)	0	1611	5075	0	0	5085
Link Speed (mph)	30		42			38
Link Distance (ft)	208		191			221
Travel Time (s)	4.7		3.1			4.0
Peak Hour Factor	0.92	0.92	0.92	0.92	0.92	0.92
Adj. Flow (vph)	0	37	2313	32	0	2536
Shared Lane Traffic (%)						
Lane Group Flow (vph)	0	37	2345	0	0	2536
Enter Blocked Intersection	No	No	No	No	No	No
Lane Alignment	Left	Right	Left	Right	Left	Left
Median Width(ft)	0		12			12
Link Offset(ft)	0		0			0
Crosswalk Width(ft)	16		16			16
Two way Left Turn Lane						
Headway Factor	1.00	1.00	1.00	1.00	1.00	1.00
Turning Speed (mph)	15	9		9	15	
Sign Control	Stop		Free			Free

Intersection Summary						
Area Type:	Other					
Control Type:	Unsignalized					
Intersection Capacity Utilization	51.8%		ICU Level of Service A			
Analysis Period (min)	15					

Pepper Square TIA Phase 1, P, & N - 2033 Background + Site - AM - Drive 4 Removed  
HCM 6th TWSC 26: Preston & Drive 3

Intersection						
Int Delay, s/veh	0.3					
Movement	WBL	WBR	NBT	NBR	SBL	SBT
Lane Configurations		↔	↔↔↔			↔↔↔
Traffic Vol, veh/h	0	34	2128	29	0	2333
Future Vol, veh/h	0	34	2128	29	0	2333
Conflicting Peds, #/hr	0	0	0	0	0	0
Sign Control	Stop	Stop	Free	Free	Free	Free
RT Channelized	-	None	-	None	-	None
Storage Length	-	0	-	-	-	-
Veh in Median Storage, #	0	-	0	-	-	0
Grade, %	0	-	0	-	-	0
Peak Hour Factor	92	92	92	92	92	92
Heavy Vehicles, %	2	2	2	2	2	2
Mvmt Flow	0	37	2313	32	0	2536

Major/Minor	Minor1	Major1	Major2
Conflicting Flow All	- 1173	0	0
Stage 1	-	-	-
Stage 2	-	-	-
Critical Hdwy	- 7.14	-	-
Critical Hdwy Stg 1	-	-	-
Critical Hdwy Stg 2	-	-	-
Follow-up Hdwy	- 3.92	-	-
Pot Cap-1 Maneuver	0	159	-
Stage 1	0	-	-
Stage 2	0	-	-
Platoon blocked, %	-	-	-
Mov Cap-1 Maneuver	-	159	-
Mov Cap-2 Maneuver	-	-	-
Stage 1	-	-	-
Stage 2	-	-	-

Approach	WB	NB	SB
HCM Control Delay, s	34.4	0	0
HCM LOS	D		

Minor Lane/Major Mvmt	NBT	NBRWBLn1	SBT
Capacity (veh/h)	-	-	159
HCM Lane V/C Ratio	-	-	0.232
HCM Control Delay (s)	-	-	34.4
HCM Lane LOS	-	-	D
HCM 95th %tile Q(veh)	-	-	0.9

Pepper Square TIA Phase 1, P, & N - 2033 Background + Site - AM - Drive 4 Removed  
 Lanes, Volumes, Timings 1367: Preston & Belt Line

Lane Group	EBU	EBL	EBT	EBR	WBL	WBT	WBR	NBL	NBT	NBR	SBU	SBL
Lane Configurations		↔	↔↔	↔	↔	↔↔	↔	↔↔	↔↔	↔		↔
Traffic Volume (vph)	11	171	474	278	92	936	183	366	1763	22	2	183
Future Volume (vph)	11	171	474	278	92	936	183	366	1763	22	2	183
Ideal Flow (vphpl)	1900	1900	1900	1900	1900	1900	1900	1900	1900	1900	1900	1900
Storage Length (ft)		150		150	200		0	250		0		200
Storage Lanes		2		1	1		0	2		0		1
Taper Length (ft)		25			25			25				25
Lane Util. Factor	0.91	0.97	0.91	1.00	1.00	0.91	0.91	0.97	0.91	0.91	0.91	1.00
Fr				0.850		0.975			0.998			
Flt Protected		0.950			0.950			0.950				0.950
Satd. Flow (prot)	0	3433	5085	1583	1770	4958	0	3433	5075	0	0	1770
Flt Permitted		0.950			0.950			0.950				0.950
Satd. Flow (perm)	0	3433	5085	1583	1770	4958	0	3433	5075	0	0	1770
Right Turn on Red				Yes			Yes			Yes		
Satd. Flow (RTOR)				186		25			1			
Link Speed (mph)			42			42			42			
Link Distance (ft)			925			394			261			
Travel Time (s)			15.0			6.4			4.2			
Peak Hour Factor	0.95	0.95	0.95	0.95	0.95	0.95	0.95	0.95	0.95	0.95	0.95	0.95
Adj. Flow (vph)	12	180	499	293	97	985	193	385	1856	23	2	193
Shared Lane Traffic (%)												
Lane Group Flow (vph)	0	192	499	293	97	1178	0	385	1879	0	0	195
Enter Blocked Intersection	No	No	No	No	No	No	No	No	No	No	No	No
Lane Alignment	R NA	Left	Left	Right	Left	Left	Right	Left	Left	Right	R NA	Left
Median Width(ft)			24			24			24			
Link Offset(ft)			0			0			0			
Crosswalk Width(ft)			16			16			16			
Two way Left Turn Lane												
Headway Factor	1.00	1.00	1.00	1.00	1.00	1.00	1.00	1.00	1.00	1.00	1.00	1.00
Turning Speed (mph)	9	15		9	15		9	15		9	9	15
Number of Detectors	1	1	1	1	1	1	1	1	1	1	1	1
Detector Template												
Leading Detector (ft)	50	50	50	50	50	50		50	50		50	50
Trailing Detector (ft)	0	0	0	0	0	0		0	0		0	0
Detector 1 Position(ft)	0	0	0	0	0	0		0	0		0	0
Detector 1 Size(ft)	50	50	50	50	50	50		50	50		50	50
Detector 1 Type	Cl+Ex	Cl+Ex	Cl+Ex	Cl+Ex	Cl+Ex	Cl+Ex		Cl+Ex	Cl+Ex		Cl+Ex	Cl+Ex
Detector 1 Channel												
Detector 1 Extnd (s)	0.0	0.0	0.0	0.0	0.0	0.0		0.0	0.0		0.0	0.0
Detector 1 Queue (s)	0.0	0.0	0.0	0.0	0.0	0.0		0.0	0.0		0.0	0.0
Detector 1 Delay (s)	0.0	0.0	0.0	0.0	0.0	0.0		0.0	0.0		0.0	0.0
Turn Type	Prot	Prot	NA	Perm	Prot	NA		Prot	NA		Prot	Prot
Protected Phases	3	3	8		7	4		1	6		5	5
Permitted Phases				8								
Detector Phase	3	3	8	8	7	4		1	6		5	5
Switch Phase												
Minimum Initial (s)	3.0	3.0	18.0	18.0	3.0	18.0		3.0	18.0		3.0	3.0
Minimum Split (s)	11.0	11.0	32.5	32.5	8.0	32.5		8.0	33.0		11.0	11.0
Total Split (s)	16.0	16.0	42.0	42.0	20.0	46.0		18.0	76.0		22.0	22.0

Pepper Square TIA Phase 1, P, & N - 2033 Background + Site - AM - Drive 4 Removed  
 Lanes, Volumes, Timings 1367: Preston & Belt Line

Lane Group	SBT	SBR
Lane Configurations	↔↔↔	↔
Traffic Volume (vph)	1923	285
Future Volume (vph)	1923	285
Ideal Flow (vphpl)	1900	1900
Storage Length (ft)		300
Storage Lanes		1
Taper Length (ft)		
Lane Util. Factor	0.91	1.00
Fr		0.850
Flt Protected		
Satd. Flow (prot)	5085	1583
Flt Permitted		
Satd. Flow (perm)	5085	1583
Right Turn on Red		Yes
Satd. Flow (RTOR)		173
Link Speed (mph)	40	
Link Distance (ft)	3054	
Travel Time (s)	52.1	
Peak Hour Factor	0.95	0.95
Adj. Flow (vph)	2024	300
Shared Lane Traffic (%)		
Lane Group Flow (vph)	2024	300
Enter Blocked Intersection	No	No
Lane Alignment	Left	Right
Median Width(ft)	24	
Link Offset(ft)	0	
Crosswalk Width(ft)	16	
Two way Left Turn Lane		
Headway Factor	1.00	1.00
Turning Speed (mph)	9	
Number of Detectors	1	1
Detector Template		
Leading Detector (ft)	50	50
Trailing Detector (ft)	0	0
Detector 1 Position(ft)	0	0
Detector 1 Size(ft)	50	50
Detector 1 Type	Cl+Ex	Cl+Ex
Detector 1 Channel		
Detector 1 Extnd (s)	0.0	0.0
Detector 1 Queue (s)	0.0	0.0
Detector 1 Delay (s)	0.0	0.0
Turn Type	NA	Perm
Protected Phases	2	
Permitted Phases		2
Detector Phase	2	2
Switch Phase		
Minimum Initial (s)	18.0	18.0
Minimum Split (s)	33.0	33.0
Total Split (s)	80.0	80.0

Pepper Square TIA Phase 1, P, & N - 2033 Background + Site - AM - Drive 4 Removed  
 Lanes, Volumes, Timings 1367: Preston & Belt Line

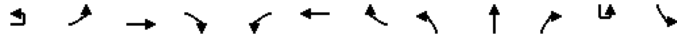

Lane Group	EBU	EBL	EBT	EBR	WBL	WBT	WBR	NBL	NBT	NBR	SBU	SBL
Total Split (%)	10.0%	10.0%	26.3%	26.3%	12.5%	28.8%		11.3%	47.5%		13.8%	13.8%
Maximum Green (s)	11.0	11.0	36.5	36.5	15.0	40.5		13.0	70.0		17.0	17.0
Yellow Time (s)	3.0	3.0	4.0	4.0	3.0	4.0		3.0	4.4		3.0	3.0
All-Red Time (s)	2.0	2.0	1.5	1.5	2.0	1.5		2.0	1.6		2.0	2.0
Lost Time Adjust (s)		-1.0	-1.5	-1.5	-1.0	-1.5		-1.0	-1.7			-1.0
Total Lost Time (s)		4.0	4.0	4.0	4.0	4.0		4.0	4.3			4.0
Lead/Lag	Lead	Lead	Lead	Lead	Lag	Lag		Lag	Lag		Lead	Lead
Lead-Lag Optimize?	Yes	Yes	Yes	Yes	Yes	Yes		Yes	Yes		Yes	Yes
Vehicle Extension (s)	1.3	1.3	1.3	1.3	1.0	1.3		1.6	2.0		1.5	1.5
Recall Mode	None	None	Max	Max	None	Max		None	C-Max		None	None
Walk Time (s)			7.0	7.0		7.0			7.0			
Flash Dont Walk (s)			20.0	20.0		20.0			20.0			
Pedestrian Calls (#/hr)			0	0		0			0			
Act Effct Green (s)		11.6	38.0	38.0	16.0	42.4		14.0	71.7			18.0
Actuated g/C Ratio		0.07	0.24	0.24	0.10	0.26		0.09	0.45			0.11
v/c Ratio		0.77	0.41	0.57	0.55	0.89		1.28	0.83			0.98
Control Delay		81.2	44.2	17.9	55.5	39.4		190.1	25.9			125.1
Queue Delay		0.0	0.0	0.0	0.0	0.0		0.0	21.0			0.0
Total Delay		81.2	44.2	17.9	55.5	39.4		190.1	46.9			125.1
LOS		F	D	B	E	D		F	D			F
Approach Delay			43.6			40.6			71.3			
Approach LOS			D			D			E			
Queue Length 50th (ft)		104	169	111	98	437		-269	755			197
Queue Length 95th (ft)		#159	210	229	m166	517		#380	547			m#269
Internal Link Dist (ft)			845			314			181			
Turn Bay Length (ft)		150		150	200			250				200
Base Capacity (vph)		257	1207	517	177	1331		300	2274			199
Starvation Cap Reductn		0	0	0	0	0		0	459			0
Spillback Cap Reductn		0	0	0	0	0		0	0			0
Storage Cap Reductn		0	0	0	0	0		0	0			0
Reduced v/c Ratio		0.75	0.41	0.57	0.55	0.89		1.28	1.04			0.98

Intersection Summary

Area Type:	Other
Cycle Length:	160
Actuated Cycle Length:	160
Offset:	81 (51%), Referenced to phase 6:NBT, Start of Yellow
Natural Cycle:	100
Control Type:	Actuated-Coordinated
Maximum v/c Ratio:	1.28
Intersection Signal Delay:	44.9
Intersection LOS:	D
Intersection Capacity Utilization:	88.5%
ICU Level of Service:	E
Analysis Period (min):	15
-	Volume exceeds capacity, queue is theoretically infinite. Queue shown is maximum after two cycles.
#	95th percentile volume exceeds capacity, queue may be longer. Queue shown is maximum after two cycles.
m	Volume for 95th percentile queue is metered by upstream signal.

Pepper Square TIA Phase 1, P, & N - 2033 Background + Site - AM - Drive 4 Removed  
 Lanes, Volumes, Timings 1367: Preston & Belt Line

Splits and Phases: 1367: Preston & Belt Line

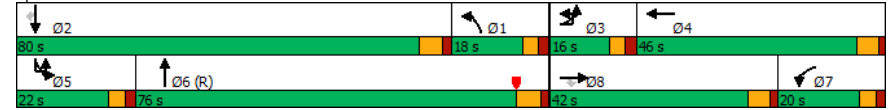



Pepper Square TIA Phase 1, P, & N - 2033 Background + Site - AM - Drive 4 Removed  
 Lanes, Volumes, Timings 1367: Preston & Belt Line

Lane Group	SBT	SBR
Total Split (%)	50.0%	50.0%
Maximum Green (s)	74.0	74.0
Yellow Time (s)	4.4	4.4
All-Red Time (s)	1.6	1.6
Lost Time Adjust (s)	-1.7	-1.7
Total Lost Time (s)	4.3	4.3
Lead/Lag	Lead	Lead
Lead-Lag Optimize?	Yes	Yes
Vehicle Extension (s)	2.5	2.5
Recall Mode	Max	Max
Walk Time (s)	7.0	7.0
Flash Dont Walk (s)	20.0	20.0
Pedestrian Calls (#/hr)	0	0
Act Effect Green (s)	75.7	75.7
Actuated g/C Ratio	0.47	0.47
v/c Ratio	0.84	0.36
Control Delay	17.4	1.5
Queue Delay	0.0	0.0
Total Delay	17.4	1.5
LOS	B	A
Approach Delay	23.8	
Approach LOS	C	
Queue Length 50th (ft)	437	4
Queue Length 95th (ft)	425	m6
Internal Link Dist (ft)	2974	
Turn Bay Length (ft)		300
Base Capacity (vph)	2405	840
Starvation Cap Reductn	0	0
Spillback Cap Reductn	2	0
Storage Cap Reductn	0	0
Reduced v/c Ratio	0.84	0.36
<b>Intersection Summary</b>		

Pepper Square TIA Phase 1, P, & N - 2033 Background + Site - AM - Drive 4 Removed  
 Lanes, Volumes, Timings 1369: Preston & Belt Line Village Driveway

Lane Group	EBL	EBT	EBR	WBL	WBT	WBR	NBL	NBT	NBR	SBU	SBL	SBT
Lane Configurations		↔↔		↔	↔		↔↔↔	↔↔↔			↔	↔↔↔
Traffic Volume (vph)	41	1	29	158	2	102	25	2007	79	3	120	2180
Future Volume (vph)	41	1	29	158	2	102	25	2007	79	3	120	2180
Ideal Flow (vphpl)	1900	1900	1900	1900	1900	1900	1900	1900	1900	1900	1900	1900
Storage Length (ft)	0		0	0		0	100		0		100	
Storage Lanes	0		0	1		0	1		0		1	
Taper Length (ft)	25			25			25				25	
Lane Util. Factor	0.95	0.95	0.95	1.00	1.00	1.00	1.00	0.91	0.91	0.91	1.00	0.91
Frt		0.939			0.853			0.994				0.998
Flt Protected		0.972		0.950			0.950				0.950	
Satd. Flow (prot)	0	3230	0	1770	1589	0	1770	5055	0	0	1770	5075
Flt Permitted		0.730		0.703			0.038				0.044	
Satd. Flow (perm)	0	2426	0	1310	1589	0	71	5055	0	0	82	5075
Right Turn on Red			Yes			Yes		Yes				
Satd. Flow (RTOR)		32			112			6				2
Link Speed (mph)		30			30			42				38
Link Distance (ft)		303			249			252				191
Travel Time (s)		6.9			5.7			4.1				3.4
Peak Hour Factor	0.90	0.90	0.90	0.90	0.90	0.90	0.90	0.90	0.90	0.90	0.90	0.90
Adj. Flow (vph)	46	1	32	176	2	113	28	2230	88	3	133	2422
Shared Lane Traffic (%)												
Lane Group Flow (vph)	0	79	0	176	115	0	28	2318	0	0	136	2455
Enter Blocked Intersection	No	No	No	No	No	No	No	No	No	No	No	No
Lane Alignment	Left	Left	Right	Left	Left	Right	Left	Left	Right	R NA	Left	Left
Median Width(ft)		12			12			12				12
Link Offset(ft)		0			0			0				0
Crosswalk Width(ft)		16			16			16				16
Two way Left Turn Lane												
Headway Factor	1.00	1.00	1.00	1.00	1.00	1.00	1.00	1.00	1.00	1.00	1.00	1.00
Turning Speed (mph)	15		9	15		9	15		9	15		15
Number of Detectors	1	1		1	1		1	1		1	1	1
Detector Template												
Leading Detector (ft)	50	50		50	50		50	50		50	50	50
Trailing Detector (ft)	0	0		0	0		0	0		0	0	0
Detector 1 Position(ft)	0	0		0	0		0	0		0	0	0
Detector 1 Size(ft)	50	50		50	50		50	50		50	50	50
Detector 1 Type	Cl+Ex	Cl+Ex		Cl+Ex	Cl+Ex		Cl+Ex	Cl+Ex		Cl+Ex	Cl+Ex	Cl+Ex
Detector 1 Channel												
Detector 1 Extend (s)	0.0	0.0		0.0	0.0		0.0	0.0		0.0	0.0	0.0
Detector 1 Queue (s)	0.0	0.0		0.0	0.0		0.0	0.0		0.0	0.0	0.0
Detector 1 Delay (s)	0.0	0.0		0.0	0.0		0.0	0.0		0.0	0.0	0.0
Turn Type	Perm	NA		Perm	NA		D.P+P	NA		custom	D.P+P	NA
Protected Phases		8			4			1	6			5
Permitted Phases		8			4			2			5	6
Detector Phase		8	8		4	4		1	6		5	5
Switch Phase												
Minimum Initial (s)	20.0	20.0		20.0	20.0		5.0	20.0		5.0	5.0	20.0
Minimum Split (s)	25.0	25.0		25.0	25.0		10.0	26.0		10.0	10.0	26.0
Total Split (s)	47.0	47.0		47.0	47.0		20.0	98.0		15.0	15.0	93.0

Pepper Square TIA Phase 1, P, & N - 2033 Background + Site - AM - Drive 4 Removed  
 Lanes, Volumes, Timings 1369: Preston & Belt Line Village Driveway

Lane Group	SBR
Left-Through Configurations	
Traffic Volume (vph)	30
Future Volume (vph)	30
Ideal Flow (vphpl)	1900
Storage Length (ft)	0
Storage Lanes	0
Taper Length (ft)	
Lane Util. Factor	0.91
Fr	
Flt Protected	
Satd. Flow (prot)	0
Flt Permitted	
Satd. Flow (perm)	0
Right Turn on Red	Yes
Satd. Flow (RTOR)	
Link Speed (mph)	
Link Distance (ft)	
Travel Time (s)	
Peak Hour Factor	0.90
Adj. Flow (vph)	33
Shared Lane Traffic (%)	
Lane Group Flow (vph)	0
Enter Blocked Intersection	No
Lane Alignment	Right
Median Width(ft)	
Link Offset(ft)	
Crosswalk Width(ft)	
Two way Left Turn Lane	
Headway Factor	1.00
Turning Speed (mph)	9
Number of Detectors	
Detector Template	
Leading Detector (ft)	
Trailing Detector (ft)	
Detector 1 Position(ft)	
Detector 1 Size(ft)	
Detector 1 Type	
Detector 1 Channel	
Detector 1 Extend (s)	
Detector 1 Queue (s)	
Detector 1 Delay (s)	
Turn Type	
Protected Phases	
Permitted Phases	
Detector Phase	
Switch Phase	
Minimum Initial (s)	
Minimum Split (s)	
Total Split (s)	

Pepper Square TIA Phase 1, P, & N - 2033 Background + Site - AM - Drive 4 Removed  
 Lanes, Volumes, Timings 1369: Preston & Belt Line Village Driveway

Lane Group	EBL	EBT	EBR	WBL	WBT	WBR	NBL	NBT	NBR	SBU	SBL	SBT
Total Split (%)	29.4%	29.4%		29.4%	29.4%		12.5%	61.3%		9.4%	9.4%	58.1%
Maximum Green (s)	42.3	42.3		42.3	42.3		15.0	93.7		10.0	10.0	88.7
Yellow Time (s)	3.0	3.0		3.0	3.0		3.0	3.0		3.0	3.0	3.0
All-Red Time (s)	1.7	1.7		1.7	1.7		2.0	1.3		2.0	2.0	1.3
Lost Time Adjust (s)		-1.0		-1.0	-1.0		-1.0	-2.0			-1.0	-2.0
Total Lost Time (s)		3.7		3.7	3.7		4.0	2.3			4.0	2.3
Lead/Lag							Lead	Lead		Lag	Lag	Lag
Lead-Lag Optimize?							Yes	Yes		Yes	Yes	Yes
Vehicle Extension (s)	2.0	2.0		2.0	2.0		1.5	3.0		1.5	1.5	3.3
Recall Mode	None	None		None	None		None	None		None	None	C-Max
Walk Time (s)	5.0	5.0		5.0	5.0			7.0				7.0
Flash Dont Walk (s)	15.0	15.0		15.0	15.0			8.0				8.0
Pedestrian Calls (#/hr)	0	0		0	0			0				0
Act Effct Green (s)		27.8		27.8	27.8		122.1	94.4			120.5	120.1
Actuated g/C Ratio		0.17		0.17	0.17		0.76	0.59			0.75	0.75
v/c Ratio		0.18		0.78	0.31		0.24	0.78			0.38	0.64
Control Delay		33.3		84.8	11.1		16.2	9.0			27.0	3.0
Queue Delay		0.0		0.0	0.0		0.0	2.4			0.0	0.1
Total Delay		33.3		84.8	11.1		16.2	11.4			27.0	3.1
LOS		C		F	B		B	B			C	A
Approach Delay		33.3			55.7			11.5				4.3
Approach LOS		C			E			B				A
Queue Length 50th (ft)		22		179	3		2	166			79	79
Queue Length 95th (ft)		45		254	57		m4	145			m134	117
Internal Link Dist (ft)		223			169			172				111
Turn Bay Length (ft)							100				100	
Base Capacity (vph)		679		354	511		225	3047			355	3809
Starvation Cap Reductn		0		0	0		0	62			0	331
Spillback Cap Reductn		1		0	12		0	573			0	0
Storage Cap Reductn		0		0	0		0	0			0	0
Reduced v/c Ratio		0.12		0.50	0.23		0.12	0.94			0.38	0.71

**Intersection Summary**  
 Area Type: Other  
 Cycle Length: 160  
 Actuated Cycle Length: 160  
 Offset: 86 (54%), Referenced to phase 2:NBSB, Start of Yellow  
 Natural Cycle: 75  
 Control Type: Actuated-Coordinated  
 Maximum v/c Ratio: 0.78  
 Intersection Signal Delay: 10.7 Intersection LOS: B  
 Intersection Capacity Utilization 74.0% ICU Level of Service D  
 Analysis Period (min) 15  
 m Volume for 95th percentile queue is metered by upstream signal.

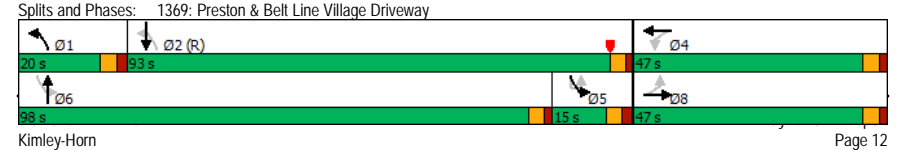



Lane Group	SBR
Total Split (%)	
Maximum Green (s)	
Yellow Time (s)	
All-Red Time (s)	
Lost Time Adjust (s)	
Total Lost Time (s)	
Lead/Lag	
Lead-Lag Optimize?	
Vehicle Extension (s)	
Recall Mode	
Walk Time (s)	
Flash Dont Walk (s)	
Pedestrian Calls (#/hr)	
Act Effct Green (s)	
Actuated g/C Ratio	
v/c Ratio	
Control Delay	
Queue Delay	
Total Delay	
LOS	
Approach Delay	
Approach LOS	
Queue Length 50th (ft)	
Queue Length 95th (ft)	
Internal Link Dist (ft)	
Turn Bay Length (ft)	
Base Capacity (vph)	
Starvation Cap Reductn	
Spillback Cap Reductn	
Storage Cap Reductn	
Reduced v/c Ratio	
Intersection Summary	

Pepper Square TIA Phase 1, P, & N - 2033 Background + Site - PM - Drive 4 Removed  
 Lanes, Volumes, Timings 25: Preston & Drive 4



Lane Group	WBL	WBR	NBT	NBR	SBL	SBT
Lane Configurations		↔	↔↔↔			↔↔↔
Traffic Volume (vph)	0	0	2668	0	0	2253
Future Volume (vph)	0	0	2668	0	0	2253
Ideal Flow (vphpl)	1900	1900	1900	1900	1900	1900
Lane Util. Factor	1.00	1.00	0.91	0.91	1.00	0.91
Frt						
Flt Protected						
Satd. Flow (prot)	0	1863	5085	0	0	5085
Flt Permitted						
Satd. Flow (perm)	0	1863	5085	0	0	5085
Link Speed (mph)	30		42			38
Link Distance (ft)	173		221			261
Travel Time (s)	3.9		3.6			4.7
Peak Hour Factor	0.95	0.95	0.95	0.95	0.95	0.95
Adj. Flow (vph)	0	0	2808	0	0	2372
Shared Lane Traffic (%)						
Lane Group Flow (vph)	0	0	2808	0	0	2372
Enter Blocked Intersection	No	No	No	No	No	No
Lane Alignment	Left	Right	Left	Right	Left	Left
Median Width(ft)	0		24			24
Link Offset(ft)	0		0			0
Crosswalk Width(ft)	16		16			16
Two way Left Turn Lane						
Headway Factor	1.00	1.00	1.00	1.00	1.00	1.00
Turning Speed (mph)	15	9		9	15	
Sign Control	Stop		Free			Free

Intersection Summary	
Area Type:	Other
Control Type:	Unsignalized
Intersection Capacity Utilization	54.9%
ICU Level of Service A	
Analysis Period (min)	15

Pepper Square TIA Phase 1, P, & N - 2033 Background + Site - PM - Drive 4 Removed  
 HCM 6th TWSC 25: Preston & Drive 4

Intersection						
Int Delay, s/veh	0					
Movement	WBL	WBR	NBT	NBR	SBL	SBT
Lane Configurations		↔	↔↔↔			↔↔↔
Traffic Vol, veh/h	0	0	2668	0	0	2253
Future Vol, veh/h	0	0	2668	0	0	2253
Conflicting Peds, #/hr	0	0	0	0	0	0
Sign Control	Stop	Stop	Free	Free	Free	Free
RT Channelized	-	None	-	None	-	None
Storage Length	-	0	-	-	-	-
Veh in Median Storage, #	0	-	0	-	-	0
Grade, %	0	-	0	-	-	0
Peak Hour Factor	95	95	95	95	95	95
Heavy Vehicles, %	2	2	2	2	2	2
Mvmt Flow	0	0	2808	0	0	2372

Major/Minor	Minor1	Major1	Major2
Conflicting Flow All	- 1404	0	0
Stage 1	-	-	-
Stage 2	-	-	-
Critical Hdwy	- 7.14	-	-
Critical Hdwy Stg 1	-	-	-
Critical Hdwy Stg 2	-	-	-
Follow-up Hdwy	- 3.92	-	-
Pot Cap-1 Maneuver	0	111	-
Stage 1	0	-	-
Stage 2	0	-	-
Platoon blocked, %	-	-	-
Mov Cap-1 Maneuver	-	111	-
Mov Cap-2 Maneuver	-	-	-
Stage 1	-	-	-
Stage 2	-	-	-

Approach	WB	NB	SB
HCM Control Delay, s	0	0	0
HCM LOS	A		

Minor Lane/Major Mvmt	NBT	NBRWBLn1	SBT
Capacity (veh/h)	-	-	-
HCM Lane V/C Ratio	-	-	-
HCM Control Delay (s)	-	0	-
HCM Lane LOS	-	A	-
HCM 95th %tile Q(veh)	-	-	-

Pepper Square TIA Phase 1, P, & N - 2033 Background + Site - PM - Drive 4 Removed  
 Lanes, Volumes, Timings 26: Preston & Drive 3



Lane Group	WBL	WBR	NBT	NBR	SBL	SBT
Lane Configurations		↑	↑↑↑			↑↑↑
Traffic Volume (vph)	0	51	2637	45	0	2253
Future Volume (vph)	0	51	2637	45	0	2253
Ideal Flow (vphpl)	1900	1900	1900	1900	1900	1900
Lane Util. Factor	1.00	1.00	0.91	0.91	1.00	0.91
Frt		0.865	0.998			
Flt Protected						
Satd. Flow (prot)	0	1611	5075	0	0	5085
Flt Permitted						
Satd. Flow (perm)	0	1611	5075	0	0	5085
Link Speed (mph)	30		42			38
Link Distance (ft)	208		191			221
Travel Time (s)	4.7		3.1			4.0
Peak Hour Factor	0.95	0.95	0.95	0.95	0.95	0.95
Adj. Flow (vph)	0	54	2776	47	0	2372
Shared Lane Traffic (%)						
Lane Group Flow (vph)	0	54	2823	0	0	2372
Enter Blocked Intersection	No	No	No	No	No	No
Lane Alignment	Left	Right	Left	Right	Left	Left
Median Width(ft)	0		12			12
Link Offset(ft)	0		0			0
Crosswalk Width(ft)	16		16			16
Two way Left Turn Lane						
Headway Factor	1.00	1.00	1.00	1.00	1.00	1.00
Turning Speed (mph)	15	9		9	15	
Sign Control	Stop		Free			Free

Intersection Summary						
Area Type:	Other					
Control Type:	Unsignalized					
Intersection Capacity Utilization	62.0%		ICU Level of Service B			
Analysis Period (min)	15					

Pepper Square TIA Phase 1, P, & N - 2033 Background + Site - PM - Drive 4 Removed  
 HCM 6th TWSC 26: Preston & Drive 3

Intersection						
Int Delay, s/veh	0.7					
Movement	WBL	WBR	NBT	NBR	SBL	SBT
Lane Configurations		↑	↑↑↑			↑↑↑
Traffic Vol, veh/h	0	51	2637	45	0	2253
Future Vol, veh/h	0	51	2637	45	0	2253
Conflicting Peds, #/hr	0	0	0	0	0	0
Sign Control	Stop	Stop	Free	Free	Free	Free
RT Channelized	-	None	-	None	-	None
Storage Length	-	0	-	-	-	-
Veh in Median Storage, #	0	-	0	-	-	0
Grade, %	0	-	0	-	-	0
Peak Hour Factor	95	95	95	95	95	95
Heavy Vehicles, %	2	2	2	2	2	2
Mvmt Flow	0	54	2776	47	0	2372

Major/Minor	Minor1	Major1	Major2
Conflicting Flow All	- 1412	0	0
Stage 1	-	-	-
Stage 2	-	-	-
Critical Hdwy	- 7.14	-	-
Critical Hdwy Stg 1	-	-	-
Critical Hdwy Stg 2	-	-	-
Follow-up Hdwy	- 3.92	-	-
Pot Cap-1 Maneuver	0	109	-
Stage 1	0	-	-
Stage 2	0	-	-
Platoon blocked, %	-	-	-
Mov Cap-1 Maneuver	-	109	-
Mov Cap-2 Maneuver	-	-	-
Stage 1	-	-	-
Stage 2	-	-	-

Approach	WB	NB	SB
HCM Control Delay, s	66.5	0	0
HCM LOS	F		

Minor Lane/Major Mvmt	NBT	NBRWBLn1	SBT
Capacity (veh/h)	-	-	109
HCM Lane V/C Ratio	-	-	0.493
HCM Control Delay (s)	-	-	66.5
HCM Lane LOS	-	-	F
HCM 95th %tile Q(veh)	-	-	2.2

Pepper Square TIA Phase 1, P, & N - 2033 Background + Site - PM - Drive 4 Removed  
 Lanes, Volumes, Timings 1367: Preston & Belt Line



Lane Group	EBU	EBL	EBT	EBR	WBU	WBL	WBT	WBR	NBL	NBT	NBR	SBU
Lane Configurations		↔	↔↔	↔		↔	↔↔		↔	↔↔		
Traffic Volume (vph)	47	405	1105	470	1	108	736	161	552	2041	64	2
Future Volume (vph)	47	405	1105	470	1	108	736	161	552	2041	64	2
Ideal Flow (vphpl)	1900	1900	1900	1900	1900	1900	1900	1900	1900	1900	1900	1900
Storage Length (ft)		150		150		200		0	250		0	
Storage Lanes		2		1		1		0	2		0	
Taper Length (ft)		25				25			25			
Lane Util. Factor	0.91	0.97	0.91	1.00	0.91	1.00	0.91	0.91	0.97	0.91	0.91	0.91
Fr				0.850					0.973		0.995	
Flt Protected		0.950				0.950			0.950			
Satd. Flow (prot)	0	3433	5085	1583	0	1770	4948	0	3433	5060	0	0
Flt Permitted		0.950				0.950			0.950			
Satd. Flow (perm)	0	3433	5085	1583	0	1770	4948	0	3433	5060	0	0
Right Turn on Red				Yes			Yes				Yes	
Satd. Flow (RTOR)				257			25			4		
Link Speed (mph)			42				42			42		
Link Distance (ft)			925				394			261		
Travel Time (s)			15.0				6.4			4.2		
Peak Hour Factor	0.96	0.96	0.96	0.96	0.96	0.96	0.96	0.96	0.96	0.96	0.96	0.96
Adj. Flow (vph)	49	422	1151	490	1	113	767	168	575	2126	67	2
Shared Lane Traffic (%)												
Lane Group Flow (vph)	0	471	1151	490	0	114	935	0	575	2193	0	0
Enter Blocked Intersection	No	No	No	No	No	No	No	No	No	No	No	No
Lane Alignment	R NA	Left	Left	Right	R NA	Left	Right	Left	Left	Right	R NA	
Median Width(ft)			24				24			24		
Link Offset(ft)			0				0			0		
Crosswalk Width(ft)			16				16			16		
Two way Left Turn Lane												
Headway Factor	1.00	1.00	1.00	1.00	1.00	1.00	1.00	1.00	1.00	1.00	1.00	1.00
Turning Speed (mph)	9	15		9	9	15		9	15		9	9
Number of Detectors	1	1	1	1	1	1	1	1	1	1	1	1
Detector Template												
Leading Detector (ft)	50	50	50	50	50	50	50		50	50		50
Trailing Detector (ft)	0	0	0	0	0	0	0		0	0		0
Detector 1 Position(ft)	0	0	0	0	0	0	0		0	0		0
Detector 1 Size(ft)	50	50	50	50	50	50	50		50	50		50
Detector 1 Type	Cl+Ex	Cl+Ex	Cl+Ex	Cl+Ex	Cl+Ex	Cl+Ex	Cl+Ex		Cl+Ex	Cl+Ex		Cl+Ex
Detector 1 Channel												
Detector 1 Extend (s)	0.0	0.0	0.0	0.0	0.0	0.0	0.0		0.0	0.0		0.0
Detector 1 Queue (s)	0.0	0.0	0.0	0.0	0.0	0.0	0.0		0.0	0.0		0.0
Detector 1 Delay (s)	0.0	0.0	0.0	0.0	0.0	0.0	0.0		0.0	0.0		0.0
Turn Type	Prot	Prot	NA	Perm	Prot	Prot	NA		Prot	NA		Prot
Protected Phases	3 13	3 13	8		17	17	4		1 11	6		5
Permitted Phases				8								
Detector Phase	3 13	3 13	8	8	17	17	4		1 11	6		5
Switch Phase												
Minimum Initial (s)			18.0	18.0	3.0	3.0	18.0			18.0		3.0
Minimum Split (s)			32.5	32.5	8.0	8.0	32.5			33.0		11.0
Total Split (s)			50.0	50.0	14.0	14.0	27.0			77.0		19.0

Pepper Square TIA Phase 1, P, & N - 2033 Background + Site - PM - Drive 4 Removed  
 Lanes, Volumes, Timings 1367: Preston & Belt Line



Lane Group	SBL	SBT	SBR	Ø1	Ø3	Ø11	Ø13
Lane Configurations	↔	↔↔	↔				
Traffic Volume (vph)	194	1570	295				
Future Volume (vph)	194	1570	295				
Ideal Flow (vphpl)	1900	1900	1900				
Storage Length (ft)	200		300				
Storage Lanes	1		1				
Taper Length (ft)	25						
Lane Util. Factor	1.00	0.91	1.00				
Fr			0.850				
Flt Protected	0.950						
Satd. Flow (prot)	1770	5085	1583				
Flt Permitted	0.950						
Satd. Flow (perm)	1770	5085	1583				
Right Turn on Red			Yes				
Satd. Flow (RTOR)			230				
Link Speed (mph)		40					
Link Distance (ft)		3054					
Travel Time (s)		52.1					
Peak Hour Factor	0.96	0.96	0.96				
Adj. Flow (vph)	202	1635	307				
Shared Lane Traffic (%)							
Lane Group Flow (vph)	204	1635	307				
Enter Blocked Intersection	No	No	No				
Lane Alignment	Left	Left	Right				
Median Width(ft)		24					
Link Offset(ft)		0					
Crosswalk Width(ft)		16					
Two way Left Turn Lane							
Headway Factor	1.00	1.00	1.00				
Turning Speed (mph)	15		9				
Number of Detectors	1	1	1				
Detector Template							
Leading Detector (ft)	50	50	50				
Trailing Detector (ft)	0	0	0				
Detector 1 Position(ft)	0	0	0				
Detector 1 Size(ft)	50	50	50				
Detector 1 Type	Cl+Ex	Cl+Ex	Cl+Ex				
Detector 1 Channel							
Detector 1 Extend (s)	0.0	0.0	0.0				
Detector 1 Queue (s)	0.0	0.0	0.0				
Detector 1 Delay (s)	0.0	0.0	0.0				
Turn Type	Prot	NA	Perm				
Protected Phases	5	2		1	3	11	13
Permitted Phases			2				
Detector Phase	5	2	2				
Switch Phase							
Minimum Initial (s)	3.0	18.0	18.0	3.0	3.0	3.0	3.0
Minimum Split (s)	11.0	33.0	33.0	8.0	11.0	8.0	11.0
Total Split (s)	19.0	60.0	60.0	16.0	20.0	20.0	17.0

Pepper Square TIA Phase 1, P, & N - 2033 Background + Site - PM - Drive 4 Removed  
 Lanes, Volumes, Timings 1367: Preston & Belt Line

Lane Group	EBU	EBL	EBT	EBR	WBU	WBL	WBT	WBR	NBL	NBT	NBR	SBU
Total Split (%)			31.3%	31.3%	8.8%	8.8%	16.9%				48.1%	11.9%
Maximum Green (s)			44.5	44.5	9.0	9.0	21.5				71.0	14.0
Yellow Time (s)			4.0	4.0	3.0	3.0	4.0				4.4	3.0
All-Red Time (s)			1.5	1.5	2.0	2.0	1.5				1.6	2.0
Lost Time Adjust (s)			-1.5	-1.5		-1.0	-1.5				-1.7	
Total Lost Time (s)			4.0	4.0		4.0	4.0				4.3	
Lead/Lag										Lag	Lag	Lead
Lead-Lag Optimize?										Yes	Yes	Yes
Vehicle Extension (s)			1.3	1.3	3.0	3.0	1.3				2.0	1.5
Recall Mode			Max	Max	None	None	Max				C-Max	None
Walk Time (s)			7.0	7.0			7.0				7.0	
Flash Dont Walk (s)			20.0	20.0			20.0				20.0	
Pedestrian Calls (#/hr)			0	0			0				0	
Act Effct Green (s)		28.9	46.0	46.0		10.0	23.1		28.0		72.7	
Actuated g/C Ratio		0.18	0.29	0.29		0.06	0.14		0.18		0.45	
v/c Ratio		0.76	0.79	0.77		1.04	1.27		0.96		0.95	
Control Delay		60.2	61.9	39.7		146.2	162.0		70.2		29.9	
Queue Delay		0.0	0.0	0.0		0.0	0.0		0.0		14.4	
Total Delay		60.2	61.9	39.7		146.2	162.0		70.2		44.2	
LOS		E	E	D		F	F		E		D	
Approach Delay			56.4				160.2				49.6	
Approach LOS			E				F				D	
Queue Length 50th (ft)		200	432	275		-130	-432		251		795	
Queue Length 95th (ft)		274	488	449		#269	#528		#396		#734	
Internal Link Dist (ft)			845				314				181	
Turn Bay Length (ft)		150		150		200			250			
Base Capacity (vph)		622	1461	638		110	734		600		2301	
Starvation Cap Reductn		0	0	0		0	0		0		165	
Spillback Cap Reductn		0	0	1		0	0		0		0	
Storage Cap Reductn		0	0	0		0	0		0		0	
Reduced v/c Ratio		0.76	0.79	0.77		1.04	1.27		0.96		1.03	

**Intersection Summary**  
 Area Type: Other  
 Cycle Length: 160  
 Actuated Cycle Length: 160  
 Offset: 56 (35%), Referenced to phase 6:NBT, Start of Yellow  
 Natural Cycle: 145  
 Control Type: Actuated-Coordinated  
 Maximum v/c Ratio: 1.27  
 Intersection Signal Delay: 67.1 Intersection LOS: E  
 Intersection Capacity Utilization 96.0% ICU Level of Service F  
 Analysis Period (min) 15  
 - Volume exceeds capacity, queue is theoretically infinite.  
 Queue shown is maximum after two cycles.  
 # 95th percentile volume exceeds capacity, queue may be longer.  
 Queue shown is maximum after two cycles.  
 m Volume for 95th percentile queue is metered by upstream signal.

Pepper Square TIA Phase 1, P, & N - 2033 Background + Site - PM - Drive 4 Removed  
 Lanes, Volumes, Timings 1367: Preston & Belt Line

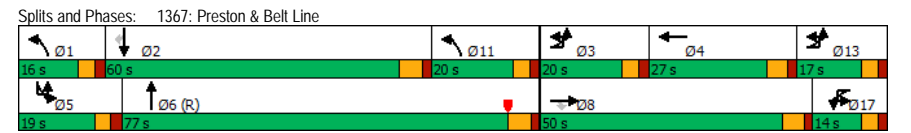

Pepper Square TIA Phase 1, P, & N - 2033 Background + Site - PM - Drive 4 Removed  
 Lanes, Volumes, Timings 1367: Preston & Belt Line



Lane Group	SBL	SBT	SBR	Ø1	Ø3	Ø11	Ø13
Total Split (%)	11.9%	37.5%	37.5%	10%	13%	13%	11%
Maximum Green (s)	14.0	54.0	54.0	11.0	15.0	15.0	12.0
Yellow Time (s)	3.0	4.4	4.4	3.0	3.0	3.0	3.0
All-Red Time (s)	2.0	1.6	1.6	2.0	2.0	2.0	2.0
Lost Time Adjust (s)	-1.0	-1.7	-1.7				
Total Lost Time (s)	4.0	4.3	4.3				
Lead/Lag	Lead	Lag	Lag	Lead	Lead		
Lead-Lag Optimize?	Yes	Yes	Yes	Yes	Yes		
Vehicle Extension (s)	1.5	2.5	2.5	1.6	1.3	3.0	3.0
Recall Mode	None	Max	Max	None	None	None	None
Walk Time (s)		7.0	7.0				
Flash Dont Walk (s)		20.0	20.0				
Pedestrian Calls (#/hr)		0	0				
Act Effect Green (s)	15.0	55.7	55.7				
Actuated g/C Ratio	0.09	0.35	0.35				
v/c Ratio	1.24	0.92	0.44				
Control Delay	178.3	47.0	9.8				
Queue Delay	0.0	0.8	0.0				
Total Delay	178.3	47.7	9.8				
LOS	F	D	A				
Approach Delay		54.7					
Approach LOS		D					
Queue Length 50th (ft)	-259	642	132				
Queue Length 95th (ft)	m#322	m680	m122				
Internal Link Dist (ft)		2974					
Turn Bay Length (ft)	200		300				
Base Capacity (vph)	165	1770	701				
Starvation Cap Reductn	0	0	0				
Spillback Cap Reductn	0	29	0				
Storage Cap Reductn	0	0	0				
Reduced v/c Ratio	1.24	0.94	0.44				
<b>Intersection Summary</b>							

Pepper Square TIA Phase 1, P, & N - 2033 Background + Site - PM - Drive 4 Removed  
 Lanes, Volumes, Timings 1369: Preston & Belt Line Village Driveway



Lane Group	EBL	EBT	EBR	WBL	WBT	WBR	NBU	NBL	NBT	NBR	SBU	SBL
Lane Configurations		↔↔		↔	↔			↔↔↔	↔↔↔			↔
Traffic Volume (vph)	82	5	55	123	6	92	1	69	2416	94	8	167
Future Volume (vph)	82	5	55	123	6	92	1	69	2416	94	8	167
Ideal Flow (vphpl)	1900	1900	1900	1900	1900	1900	1900	1900	1900	1900	1900	1900
Storage Length (ft)	0		0	0		0		100		0		100
Storage Lanes	0		0	1		0		1		0		1
Taper Length (ft)	25			25				25				25
Lane Util. Factor	0.95	0.95	0.95	1.00	1.00	1.00	0.91	1.00	0.91	0.91	0.91	1.00
Fr		0.942			0.859			0.994				
Flt Protected		0.972		0.950				0.950				0.950
Satd. Flow (prot)	0	3241	0	1770	1600	0	0	1770	5055	0	0	1770
Flt Permitted		0.692		0.595				0.060				0.035
Satd. Flow (perm)	0	2307	0	1108	1600	0	0	112	5055	0	0	65
Right Turn on Red			Yes			Yes				Yes		
Satd. Flow (RTOR)		57			95				6			
Link Speed (mph)		30			30				42			
Link Distance (ft)		303			249				252			
Travel Time (s)		6.9			5.7				4.1			
Peak Hour Factor	0.97	0.97	0.97	0.97	0.97	0.97	0.97	0.97	0.97	0.97	0.97	0.97
Adj. Flow (vph)	85	5	57	127	6	95	1	71	2491	97	8	172
Shared Lane Traffic (%)												
Lane Group Flow (vph)	0	147	0	127	101	0	0	72	2588	0	0	180
Enter Blocked Intersection	No	No	No	No	No	No	No	No	No	No	No	No
Lane Alignment	Left	Left	Right	Left	Left	Right	R NA	Left	Left	Right	R NA	Left
Median Width(ft)		12			12				12			
Link Offset(ft)		0			0				0			
Crosswalk Width(ft)		16			16				16			
Two way Left Turn Lane												
Headway Factor	1.00	1.00	1.00	1.00	1.00	1.00	1.00	1.00	1.00	1.00	1.00	1.00
Turning Speed (mph)	15		9	15		9	9	15		9	9	15
Number of Detectors	1	1		1	1		1	1	1		1	1
Detector Template												
Leading Detector (ft)	50	50		50	50		50	50	50		50	50
Trailing Detector (ft)	0	0		0	0		0	0	0		0	0
Detector 1 Position(ft)	0	0		0	0		0	0	0		0	0
Detector 1 Size(ft)	50	50		50	50		50	50	50		50	50
Detector 1 Type	Cl+Ex	Cl+Ex		Cl+Ex	Cl+Ex		Cl+Ex	Cl+Ex	Cl+Ex		Cl+Ex	Cl+Ex
Detector 1 Channel												
Detector 1 Extend (s)	0.0	0.0		0.0	0.0		0.0	0.0	0.0		0.0	0.0
Detector 1 Queue (s)	0.0	0.0		0.0	0.0		0.0	0.0	0.0		0.0	0.0
Detector 1 Delay (s)	0.0	0.0		0.0	0.0		0.0	0.0	0.0		0.0	0.0
Turn Type	Perm	NA		Perm	NA		custom	D.P+P	NA		custom	D.P+P
Protected Phases		8			4			1	6			5
Permitted Phases		8			4			1	2			5
Detector Phases		8	8		4	4		1	1	6		5
Switch Phase												
Minimum Initial (s)	20.0	20.0		20.0	20.0		5.0	5.0	20.0		5.0	5.0
Minimum Split (s)	25.0	25.0		25.0	25.0		10.0	10.0	26.0		10.0	10.0
Total Split (s)	47.0	47.0		47.0	47.0		20.0	20.0	98.0		15.0	15.0



Pepper Square TIA Phase 1, P, & N - 2033 Background + Site - PM - Drive 4 Removed  
 Lanes, Volumes, Timings 1369: Preston & Belt Line Village Driveway

Lane Group	SBT	SBR
Lane Configurations	↑↑↑	
Traffic Volume (vph)	2049	27
Future Volume (vph)	2049	27
Ideal Flow (vphpl)	1900	1900
Storage Length (ft)		0
Storage Lanes		0
Taper Length (ft)		
Lane Util. Factor	0.91	0.91
Frt	0.998	
Flt Protected		
Satd. Flow (prot)	5075	0
Flt Permitted		
Satd. Flow (perm)	5075	0
Right Turn on Red		Yes
Satd. Flow (RTOR)	2	
Link Speed (mph)	38	
Link Distance (ft)	191	
Travel Time (s)	3.4	
Peak Hour Factor	0.97	0.97
Adj. Flow (vph)	2112	28
Shared Lane Traffic (%)		
Lane Group Flow (vph)	2140	0
Enter Blocked Intersection	No	No
Lane Alignment	Left	Right
Median Width(ft)	12	
Link Offset(ft)	0	
Crosswalk Width(ft)	16	
Two way Left Turn Lane		
Headway Factor	1.00	1.00
Turning Speed (mph)		9
Number of Detectors	1	
Detector Template		
Leading Detector (ft)	50	
Trailing Detector (ft)	0	
Detector 1 Position(ft)	0	
Detector 1 Size(ft)	50	
Detector 1 Type	Cl+Ex	
Detector 1 Channel		
Detector 1 Extnd (s)	0.0	
Detector 1 Queue (s)	0.0	
Detector 1 Delay (s)	0.0	
Turn Type	NA	
Protected Phases	2	
Permitted Phases		
Detector Phase	2	
Switch Phase		
Minimum Initial (s)	20.0	
Minimum Split (s)	26.0	
Total Split (s)	93.0	

Pepper Square TIA Phase 1, P, & N - 2033 Background + Site - PM - Drive 4 Removed  
 Lanes, Volumes, Timings 1369: Preston & Belt Line Village Driveway

Lane Group	EBL	EBT	EBR	WBL	WBT	WBR	NBU	NBL	NBT	NBR	SBU	SBL
Total Split (%)	29.4%	29.4%		29.4%	29.4%		12.5%	12.5%	61.3%		9.4%	9.4%
Maximum Green (s)	42.3	42.3		42.3	42.3		15.0	15.0	93.7		10.0	10.0
Yellow Time (s)	3.0	3.0		3.0	3.0		3.0	3.0	3.0		3.0	3.0
All-Red Time (s)	1.7	1.7		1.7	1.7		2.0	2.0	1.3		2.0	2.0
Lost Time Adjust (s)		-1.0		-1.0	-1.0			-1.0	-2.0			-1.0
Total Lost Time (s)		3.7		3.7	3.7			4.0	2.3			4.0
Lead/Lag							Lead	Lead	Lead		Lag	Lag
Lead-Lag Optimize?							Yes	Yes	Yes		Yes	Yes
Vehicle Extension (s)	2.0	2.0		2.0	2.0		1.5	1.5	3.0		1.5	1.5
Recall Mode	None	None		None	None		None	None	Max		None	None
Walk Time (s)	5.0	5.0		5.0	5.0				7.0			
Flash Dont Walk (s)	15.0	15.0		15.0	15.0				8.0			
Pedestrian Calls (#/hr)	0	0		0	0				0			
Act Effct Green (s)		24.6		24.6	24.6			123.7	114.4			123.7
Actuated g/C Ratio		0.15		0.15	0.15			0.77	0.72			0.77
v/c Ratio		0.36		0.75	0.31			0.43	0.72			1.08
Control Delay		38.4		89.9	13.7			22.4	3.8			118.3
Queue Delay		0.0		0.0	0.0			0.0	0.5			0.0
Total Delay		38.4		89.9	13.8			22.4	4.2			118.3
LOS		D		F	B			C	A			F
Approach Delay		38.4			56.1				4.7			
Approach LOS		D			E				A			
Queue Length 50th (ft)		45		131	6			9	52			-158
Queue Length 95th (ft)		77		199	58			m19	273			m#223
Internal Link Dist (ft)		223			169				172			
Turn Bay Length (ft)								100				100
Base Capacity (vph)		665		299	502			254	3614			167
Starvation Cap Reductn		0		0	0			0	507			0
Spillback Cap Reductn		2		0	7			0	435			0
Storage Cap Reductn		0		0	0			0	0			0
Reduced v/c Ratio		0.22		0.42	0.20			0.28	0.83			1.08
<b>Intersection Summary</b>												
Area Type:	Other											
Cycle Length:	160											
Actuated Cycle Length:	160											
Offset:	86 (54%), Referenced to phase 2:NBSB, Start of Yellow											
Natural Cycle:	80											
Control Type:	Actuated-Coordinated											
Maximum v/c Ratio:	1.08											
Intersection Signal Delay:	11.8						Intersection LOS: B					
Intersection Capacity Utilization	85.1%						ICU Level of Service E					
Analysis Period (min)	15											
- Volume exceeds capacity, queue is theoretically infinite.												
Queue shown is maximum after two cycles.												
# 95th percentile volume exceeds capacity, queue may be longer.												
Queue shown is maximum after two cycles.												
m Volume for 95th percentile queue is metered by upstream signal.												



Lane Group	SBT	SBR
Total Split (%)	58.1%	
Maximum Green (s)	88.7	
Yellow Time (s)	3.0	
All-Red Time (s)	1.3	
Lost Time Adjust (s)	-2.0	
Total Lost Time (s)	2.3	
Lead/Lag	Lag	
Lead-Lag Optimize?	Yes	
Vehicle Extension (s)	3.3	
Recall Mode	C-Max	
Walk Time (s)	7.0	
Flash Dont Walk (s)	8.0	
Pedestrian Calls (#/hr)	0	
Act Effct Green (s)	117.3	
Actuated g/C Ratio	0.73	
v/c Ratio	0.58	
Control Delay	4.5	
Queue Delay	0.6	
Total Delay	5.1	
LOS	A	
Approach Delay	13.9	
Approach LOS	B	
Queue Length 50th (ft)	105	
Queue Length 95th (ft)	m169	
Internal Link Dist (ft)	111	
Turn Bay Length (ft)		
Base Capacity (vph)	3721	
Starvation Cap Reductn	1055	
Spillback Cap Reductn	0	
Storage Cap Reductn	0	
Reduced v/c Ratio	0.80	
Intersection Summary		